

SATLANTIC

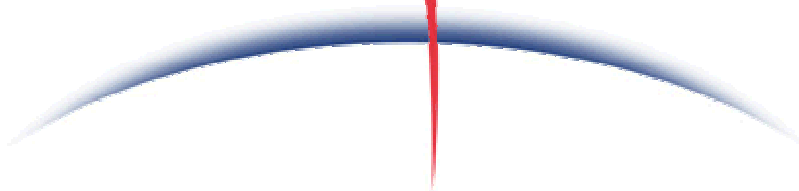

**Operation Manual for the  
HyperSAS**

Document #: SAT-DN-00212  
Revision A, December 2003

INSTRUMENT OPERATION MANUAL

[www.satlantic.com](http://www.satlantic.com)

-This page intentionally left blank-

-This page intentionally left blank-



**Operation Manual For: HyperSAS  
Document Number: SAT-DN-00212**

**Prepared by:** Satlantic Incorporated  
Richmond Terminal, Pier 9  
3481 North Marginal Road  
Halifax, Nova Scotia  
B3K-5X8  
Tel (902) 492-4780  
Fax (902) 492-4781  
Email: [support@satlantic.com](mailto:support@satlantic.com)  
Web: [www.satlantic.com](http://www.satlantic.com)

**Copyright © 2003 by Satlantic**

This document contains information proprietary to Satlantic or to a third party to which Satlantic may have legal obligation to protect such information from unauthorized disclosure, use or duplication. Any disclosure, use or duplication of this document, in whole or in part, or of any of the information contained herein for any purpose other than the specific purpose for which it was disclosed is expressly prohibited, except as Satlantic may otherwise agree to in writing.



-This page intentionally left blank-

 <b>Operation Manual</b>	SYSTEM	HyperSAS
	SECTION	<b>TABLE OF CONTENTS</b>

<b>A. OVERVIEW.....</b>	<b>A-1</b>
PURPOSE.....	A-2
BACKGROUND .....	A-2
FEATURES.....	A-2
THE HYPER SAS SYSTEM.....	A-4
MAJOR COMPONENTS .....	A-5
<i>L<sub>T</sub> Sensor</i> .....	A-5
<i>L<sub>i</sub> Sensor</i> .....	A-6
<i>E<sub>s</sub> Sensor</i> .....	A-6
<i>Network Hub</i> .....	A-8
<i>Mounting Frame</i> .....	A-10
<i>Infrared Temperature Sensor</i> .....	A-12
Notes on Measuring Surface Temperatures.....	A-12
<i>Deck Unit</i> .....	A-14
<i>Power Supply</i> .....	A-14
<i>Cables</i> .....	A-16
<i>Logging Computer</i> .....	A-16
<i>GPS Unit</i> .....	A-16
<b>B. SAFETY &amp; HAZARDS.....</b>	<b>B-1</b>
PERSONAL SAFETY .....	B-1
POWER.....	B-1
INSTRUMENTS.....	B-1
CABLE .....	B-1
CONNECTIONS .....	B-2
TROUBLESHOOTING.....	B-2
RECOVERY.....	B-2
<b>C. START UP.....</b>	<b>C-1</b>
ASSEMBLY PROCEDURE.....	C-1
<i>Preparation</i> .....	C-1
<i>System Assembly</i> .....	C-3
<i>Conduct a Simple Telemetry Test</i> .....	C-3
<b>D. OPERATION .....</b>	<b>D-1</b>
INTRODUCTION .....	D-2
FUNDAMENTALS OF SAS DEPLOYMENTS .....	D-2
<i>The Effects of Viewing Angles</i> .....	D-2
<i>Airborne Measurements</i> .....	D-3
<i>Shipboard Measurements</i> .....	D-4
FUNDAMENTALS OF SAS DATA PROCESSING .....	D-5
SYSTEM ASSEMBLY .....	D-8
<i>Assembling the SAS Mounting Frame</i> .....	D-8
<i>Mounting the L<sub>i</sub> Sensor</i> .....	D-10
<i>Mounting the L<sub>T</sub> Sensor</i> .....	D-10
<i>Mounting the Temperature Sensor</i> .....	D-10
<i>Mounting the Network Hub</i> .....	D-10
<i>Mounting the E<sub>s</sub> Sensor</i> .....	D-10

 <b>Operation Manual</b>	SYSTEM	HyperSAS
	SECTION	<b>TABLE OF CONTENTS</b>

<i>Connecting the Interconnect Cables</i> .....	D-12
<i>Powering the System</i> .....	D-13
NETWORK HUB OPERATING MODES .....	D-14
INITIALIZATION SEQUENCE.....	D-14
AUTONOMOUS OPERATION.....	D-15
NETWORK OPERATION .....	D-17
NETWORK MASTER OPERATION .....	D-18
TELEMETRY FORMAT .....	D-21
<b>E. CONFIGURATION.....</b>	<b>E-1</b>
COMMAND CONSOLE .....	E-1
<i>Reset Command</i> .....	E-4
<i>ID Command</i> .....	E-5
<i>Power Command</i> .....	E-5
<i>Set Command</i> .....	E-5
<i>Show Command</i> .....	E-6
<i>Save Command</i> .....	E-7
<i>Ping Command</i> .....	E-7
<i>Remote Command</i> .....	E-8
<i>Query Command</i> .....	E-9
<i>Sample Command</i> .....	E-10
<i>Vout Command</i> .....	E-10
<i>Exit and Exit! Commands</i> .....	E-11
HYPERNAS CONFIGURATION PARAMETERS .....	E-11
<i>Telemetry Baud Rate</i> .....	E-11
<i>Maximum Frame Rate</i> .....	E-12
<i>Initialize Silent Mode</i> .....	E-14
<i>Initialize Power Down</i> .....	E-14
<i>Initialize Automatic Telemetry</i> .....	E-14
<i>Network Mode</i> .....	E-15
<i>Network Address</i> .....	E-15
<i>Network Baud Rate</i> .....	E-15
<i>Network Master Mode</i> .....	E-16
<i>Master Controlled Telemetry</i> .....	E-16
<i>Master Network Bias</i> .....	E-17
<i>Initialize External Power</i> .....	E-17
<b>F. RECOVERY.....</b>	<b>F-1</b>
<b>G. MAINTENANCE.....</b>	<b>G-1</b>
PREVENTATIVE MAINTENANCE .....	G-1
TROUBLESHOOTING WITH HYPERTERMINAL .....	G-1
<i>Checking for HyperTerminal Installation</i> .....	G-1
<i>Installing HyperTerminal</i> .....	G-2
<i>Configuring HyperTerminal</i> .....	G-3
TROUBLESHOOTING FOR HARDWARE PROBLEMS .....	G-8
<i>Check Connections</i> .....	G-8
Procedure .....	G-8
<i>Check The Supply Voltage To The MDU-100</i> .....	G-9
Procedure .....	G-9
<i>Check The Output Voltage From The MDU-100</i> .....	G-10

 <b>Operation Manual</b>	SYSTEM	HyperSAS
	SECTION	<b>TABLE OF CONTENTS</b>

Procedure .....	G-10
<i>Check Cable Continuity</i> .....	<i>G-11</i>
Procedure .....	G-11
<b>H. WARRANTY .....</b>	<b>H-1</b>
<b>I. CONTACT INFORMATION.....</b>	<b>I-1</b>



 <b>Operation Manual</b>	SYSTEM <b>HyperSAS</b>
	SECTION <b>A. OVERVIEW</b>

## A. OVERVIEW

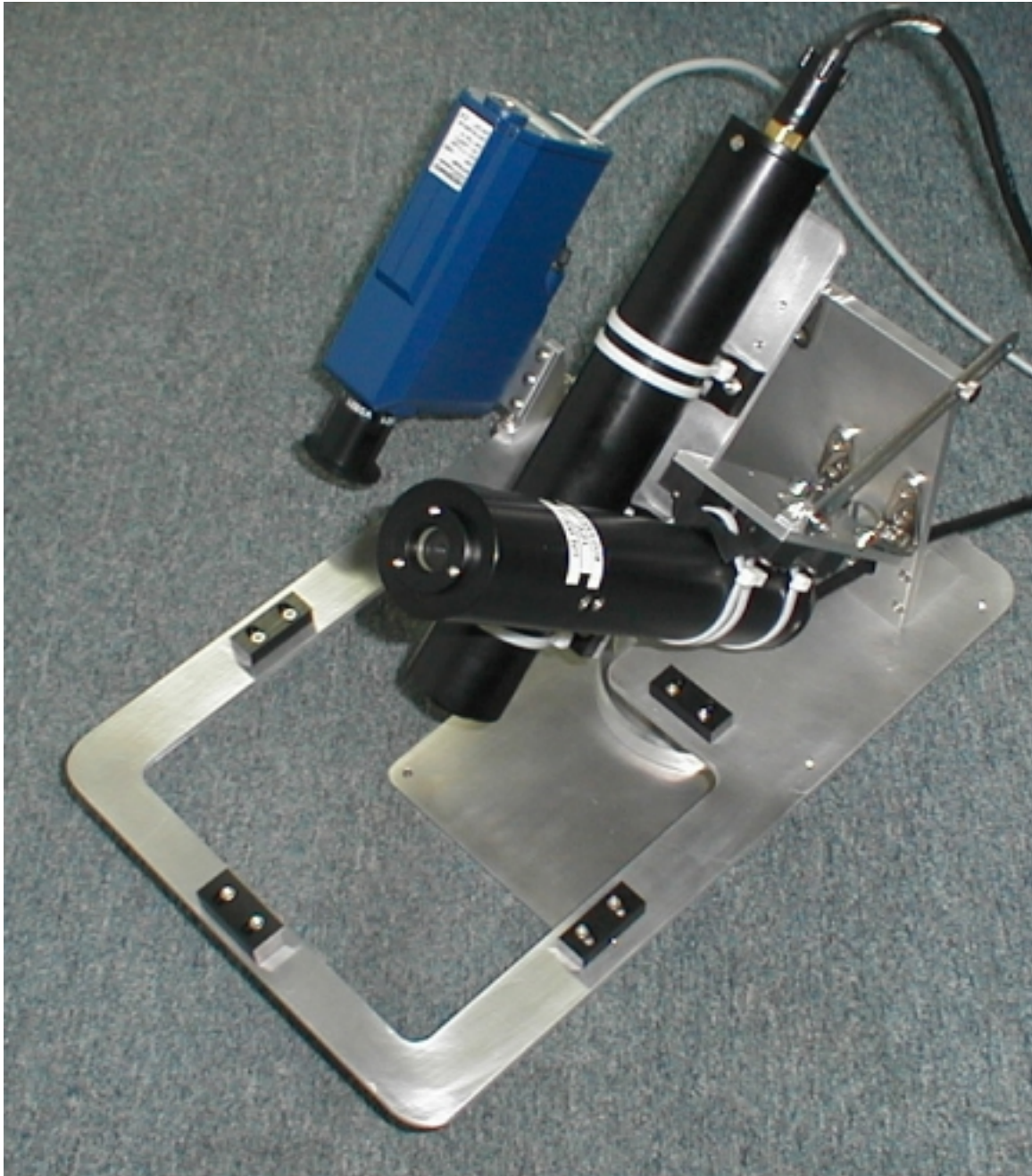

**Figure A-1: The HyperSAS**

 <b>Operation Manual</b>	SYSTEM <p style="text-align: center;"><b>HyperSAS</b></p>
	SECTION <p style="text-align: center;"><b>A. OVERVIEW</b></p>

### **Purpose**

The HyperSAS remote sensing system is designed for above-water measurements of ocean colour using Satlantic's OCR-3000 (MiniSpec) series of digital optical sensors. The primary purpose of the HyperSAS is to allow the user to obtain high-precision, high-resolution hyperspectral measurements of water-leaving spectral radiance and downwelling spectral irradiance.

*See Figure A-1, The HyperSAS*

### **Background**

The HyperSAS system normally consists of two radiance sensors and one irradiance sensor. One radiance sensor is pointed to the ocean to measure the sea surface signal ( $L_T$ ), while the other ( $L_i$ ) is pointed to the sky to provide information necessary for sea-surface glint correction. The irradiance sensor ( $E_s$ ) is used to monitor the downwelling light field and is required for computing remote sensing reflectance.

The HyperSAS can be mounted on a variety of vessels to provide continuous monitoring of ocean colour along the ship's track, on towers or other platforms to provide time series observations, or on aircraft to allow airborne remote sensing of ocean colour. The system is small, light, and compact, making it very easy to deploy.

The spectral water-leaving radiance and remote sensing reflectance obtained from HyperSAS data are used to derive the concentrations of sea-water constituents, including dissolved organic matter, suspended sediments, and chlorophyll concentration in the surface layer. Since chlorophyll is an indicator of algal biomass, this information is utilized to estimate phytoplankton abundance and marine productivity, to detect phytoplankton blooms, and to monitor organic pollution through its influence on these blooms. The HyperSAS also provides valuable surface truth for calibration and validation of satellite ocean colour products. If surface water samples are obtained simultaneously with HyperSAS measurements, the combined data set can be utilized for bio-optical modeling.

### **Features**

- Precision, high-resolution  $L_T$ ,  $L_i$ , and  $E_s$  measurements
- Compact system design
- Easy to deploy
- Adjustable viewing angles from Nadir and Zenith
- Flexible configurations
- Optional integrated surface temperature sensor
- Optional GPS unit for precision geo-referencing and time tagging

 <b>Operation Manual</b>	SYSTEM	HyperSAS
	SECTION	<b>A. OVERVIEW</b>

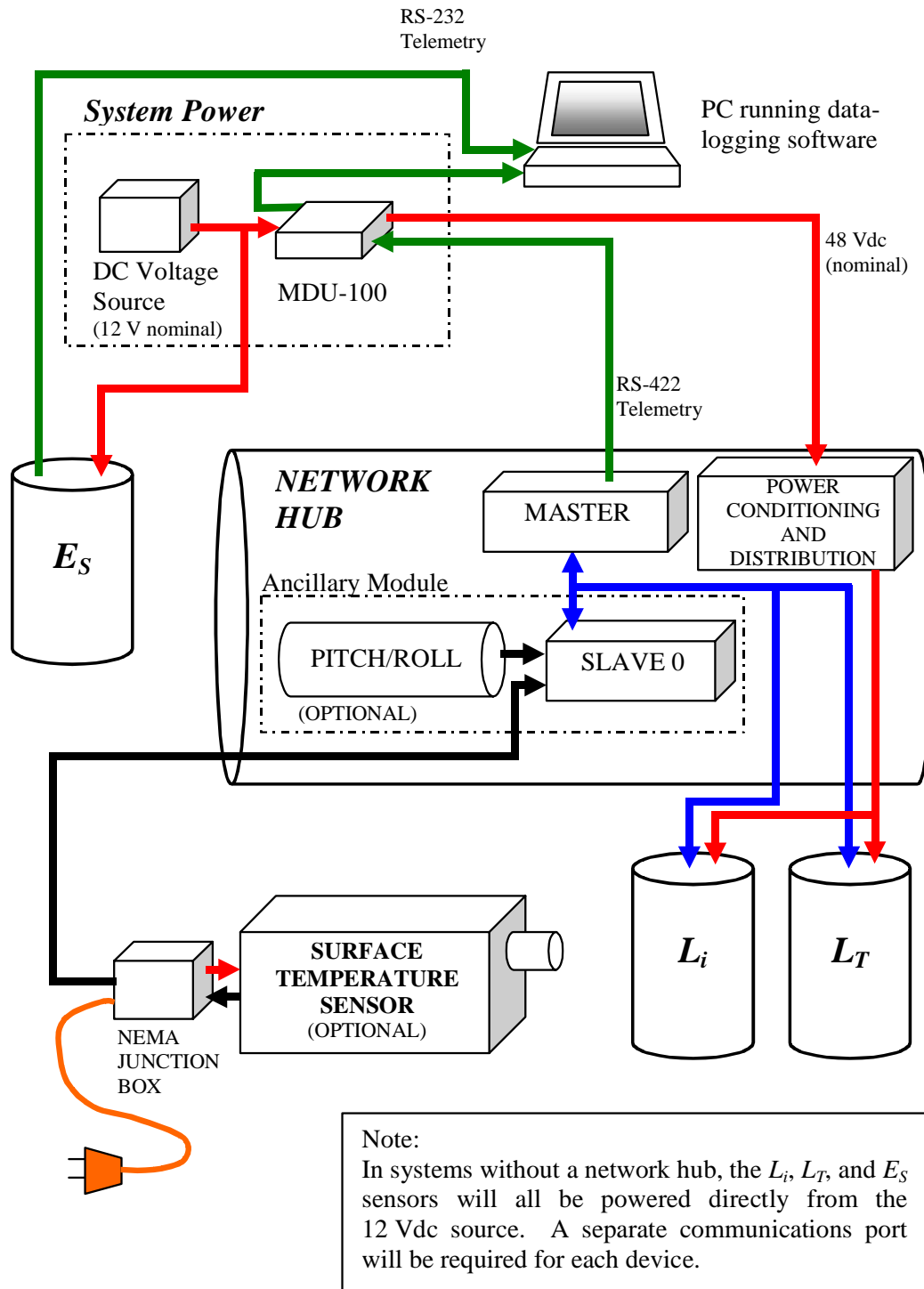

**Figure A-2: The HyperSAS Block Diagram**

 <b>Operation Manual</b>	SYSTEM	<b>HyperSAS</b>
	SECTION	<b>A. OVERVIEW</b>

### ***The HyperSAS System***

The HyperSAS system can be viewed as a grouping of modules. This modular design greatly increases the system's versatility and re-configuration potential. The basic modules are the system power module, the network hub module, the  $L_i$  and  $L_T$  sensor slave modules, the  $E_S$  sensor, the SAS mounting frame, the surface temperature sensor, and the GPS unit. All modules may not be present in a given system, depending on the user's requirements.

*See Figure A-2, HyperSAS System Block Diagram*

Please note that the GPS unit and SAS mounting frame are not shown in the figure.

The system power module is normally comprised of a 12-volt (nominal) DC power supply (usually a battery) and Satlantic's MDU-100 deck unit. The DC power supply must deliver a voltage in the range of 10 - 20 Vdc to the MDU-100 deck unit where it is converted to 48 V and sent through the power/telemetry cable to power the HyperSAS. The deck unit also converts RS-422 telemetry from the HyperSAS to RS-232 levels so that it can be sent to the computer. The  $E_S$  sensor is normally powered directly from the battery, and transmits RS-232 telemetry directly to the logging computer. In systems that do not require the network hub, the  $L_i$  and  $L_T$  sensors are powered directly from the battery and transmit RS-232 telemetry directly to the computer. Please note that when a network hub is not used, a separate communications port for each sensor ( $L_T$ ,  $L_i$ ,  $E_S$ , GPS, and temperature) will be required.

The network hub body contains the master module and the ancillary module. The master module is essentially a microcontroller board that controls the ancillary module and communicates with the slave devices via the SatNet interface. The master module's responsibilities include (but are not limited to):

- Coordinating bus access
- Issuing sample commands to the slave modules (when required)
- Retrieving data from the slave modules
- Broadcasting the data frame on the serial up-link

The ancillary slave module is also a microcontroller in the main housing of the network hub body. The ancillary module is used to obtain measurements from the optional pitch/roll (tilt) and temperature sensors. Analog measurements with the ancillary module are made using an 8-channel precision 16-bit Analog-to-Digital Converter (ADC).

 <b>Operation Manual</b>	SYSTEM <p style="text-align: center;"><b>HyperSAS</b></p>
	SECTION <p style="text-align: center;"><b>A. OVERVIEW</b></p>

### **Major Components**

The major components of the HyperSAS system are the  $L_t$ ,  $L_i$ , and  $E_s$  optical sensors, the network hub, the mounting frame, the deck unit, power supply (normally a 12 V battery), cables, and logging computer. Additionally, an infrared temperature sensor and/or GPS unit can be integrated in the HyperSAS system. Depending on user requirements, all of these components may not be present in the system. The user normally supplies the logging computer and power supply.

#### **$L_T$ Sensor**

The  $L_T$  or *spectral sea-surface radiance* sensor is a Satlantic OCR-3000 series radiance sensor. The half-angle FOV (Field-Of-View) is available in 11.5° and 3° options. Most applications will use the 3° option.

Please refer to the sensor's users manual for details on device operation.

 <b>Operation Manual</b>	SYSTEM <p style="text-align: center;"><b>HyperSAS</b></p>
	SECTION <p style="text-align: center;"><b>A. OVERVIEW</b></p>

### $L_i$ Sensor

The  $L_i$  or *indirect* (or *sky*) *radiance* sensor is a Satlantic OCR-3000 series radiance sensor. The half-angle FOV (Field-Of-View) may be matched to the application, and is available in 11.5° and 3° options. Most applications will use the 3° option.

The sky radiance sensor can collect water on the radiance faceplate, due to rain, sea spray, and condensation. To compensate for this, a small drainage hole is provided to allow moisture to drain from the radiance faceplate. **When mounting the  $L_i$  sensor, ensure that the drainage hole is the lowest point. If water is allowed to remain on the radiance faceplate, the sky radiance measurements will be adversely affected!**

Refer to the sensor's users manual for details on device operation.

### $E_s$ Sensor

The  $E_s$  or *irradiance* sensor is a Satlantic OCR-3000 series irradiance sensor. The  $E_s$  sensor should be mounted high on the ship to minimize errors due to ship shading, stack gases, and so on. Please refer to the sensor's users manual for details on device operation.

 <b>Operation Manual</b>	SYSTEM <h1 style="text-align: center;">HyperSAS</h1>
	SECTION <h2 style="text-align: center;">A. OVERVIEW</h2>

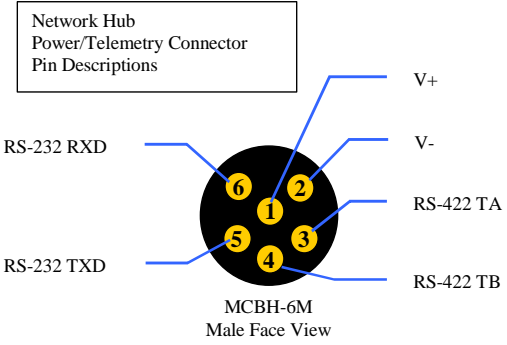
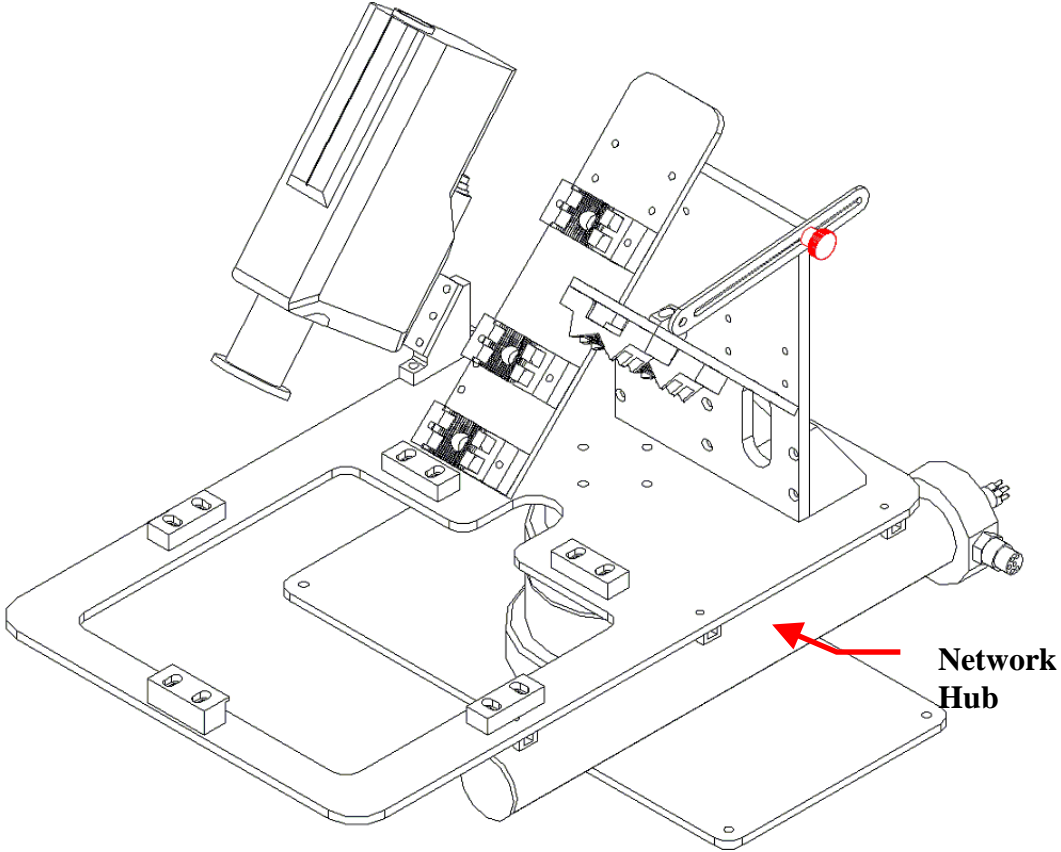

**Figure A-3: HyperSAS Network Hub**

 <b>Operation Manual</b>	SYSTEM	HyperSAS
	SECTION	<b>A. OVERVIEW</b>

## Network Hub

The *Network Hub* is an optional component in the HyperSAS system. Acting as a network controller and hub, this device allows the  $L_T$  and  $L_i$  sensors to be networked, providing power to the sensors and merging the data on a single telemetry port. Additionally, the hub can be used to provide optional pitch and roll data, and can obtain data from the surface temperature sensor.

*Refer to Figure A-3: HyperSAS Network Hub*

Please note that the hub as shown does not contain the pitch and roll sensor. Network hubs with this sensor are approximately 6.1 inches longer. Also note that the network hub connector pin-outs are indicated in the figure.

The OCR-3000 sensors are connected to the hub body through the connector shown below. Please refer to the appropriate OCR-3000 series user manual for more details on the optical sensors.

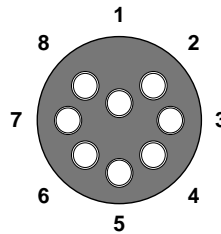
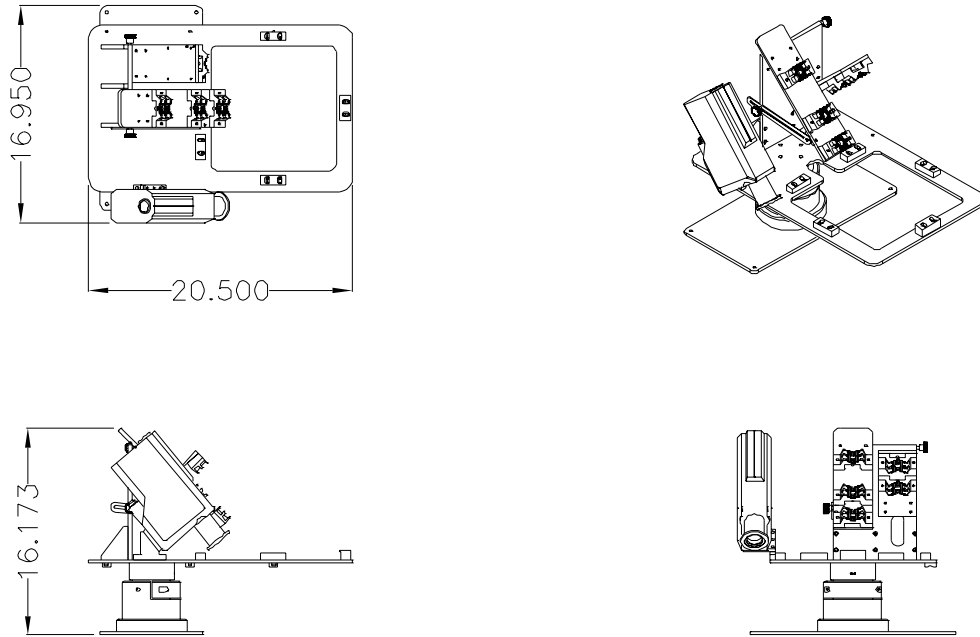

**Figure A-4: Subconn MCBH8F Female Face View**

Pin	Identification	Description
1	V+	Sensor Power (12 Volts).
2	V-/SG	Power Supply Return / Signal Ground.
3	N/C	Not internally connected.
4	N/C	Not internally connected.
5	N/C	Not internally connected.
6	N/C	Not internally connected.
7	NA	RS-485 SatNet Network Interface (A)
8	NB	RS-485 SatNet Network Interface (B)



 <b>Operation Manual</b>	SYSTEM <h1 style="text-align: center;">HyperSAS</h1>
	SECTION <h2 style="text-align: center;">A. OVERVIEW</h2>



**Figure A-5: SAS Mounting Frame**

 <b>Operation Manual</b>	SYSTEM	HyperSAS
	SECTION	<b>A. OVERVIEW</b>

## Mounting Frame

The *SAS Mounting Frame* is constructed from black anodized aluminum, providing a rugged structure for instrument mounting. The structure provides mount points for the sky radiance and water-leaving radiance sensors, as well as the optional network hub and radiation pyrometer. In addition, the frame accommodates a Spectralon™<sup>1</sup> plaque, for users who wish to obtain  $L_T$  and  $L_p$  (plaque radiance) using the same sensor.

*Refer to Figure A-5, SAS Mounting Frame*

The sky radiance and water-leaving radiance sensors are mounted to the frame using cable ties and KWIK BLOCK™<sup>2</sup> fasteners. Each sensor is mounted on a plate that connects to the SAS frame with a hinge and slotted rail arm. The rail allows adjustment of the sensors' viewing angles from Nadir or Zenith. The *Azimuthal band* located on the *rotary pedestal* allows the user to easily set the viewing angle at  $\pm 90^\circ$  from the sun's azimuth.

The network hub is mounted to the frame using cable ties and cable tie holders.

The surface temperature sensor is bolted to the frame using a mounting plate and bracket. The bracket fixes the surface temperature sensor's viewing angle at  $40^\circ$  from nadir.

<sup>1</sup> Spectralon™ is a trade mark of Labsphere, Inc. of North Sutton, New Hampshire, USA

<sup>2</sup> KWIK BLOCK™ is a trademark of KWIK BLOCK Fastening Systems, Rogue River, Oregon. USA

 <b>Operation Manual</b>	SYSTEM <b>HyperSAS</b>
	SECTION <b>A. OVERVIEW</b>

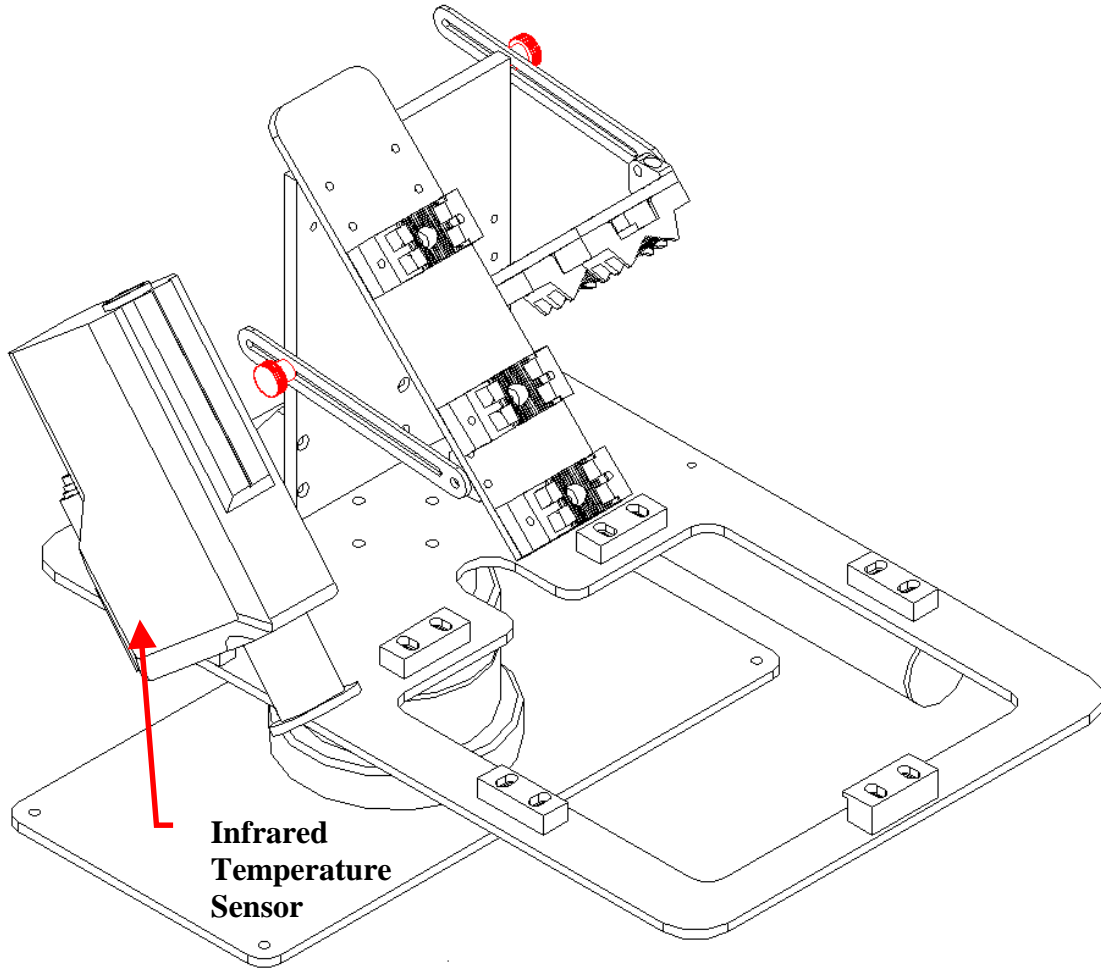

**Figure A-6: Infrared Temperature Sensor**

 <b>Operation Manual</b>	SYSTEM <p style="text-align: center;"><b>HyperSAS</b></p>
	SECTION <p style="text-align: center;"><b>A. OVERVIEW</b></p>

## Infrared Temperature Sensor

The *Infrared (IR) Temperature Sensor* is an EG&G Heimann Model KT 19.85 radiation pyrometer. This device is used to measure the sea (or land) surface temperature. The pyrometer is mounted to the SAS frame at a fixed 40° viewing angle from nadir.

*Refer to Figure A-6, Infrared Temperature Sensor*

The KT 19.85 normally outputs temperature data on its RS-232 port. However, when a network hub is present, the device is configured at Satlantic to provide an analog output to the hub's ancillary section. This effectively synchronizes and merges the temperature data with the optical data. The sensor is normally AC powered, with the power cable running to a small (130 mm X 130 mm X 75 mm) NEMA junction-box enclosure. The sensor connects to the junction box, while a third cable interfaces with the network hub.

## Notes on Measuring Surface Temperatures

At temperatures greater than absolute zero (0 Kelvin), all bodies emit electromagnetic radiation. The wavelength and density of the emitted radiation is dependent upon the temperature of the body. Below about 600 °C, the emitted wavelengths are all contained within the infrared range. The radiation density is dependent on the surface of the body; an ideal source of radiation with maximum radiation density is referred to as a *blackbody* source. The ratio of actual radiation density of the body to the maximum is the *emissivity*  $\epsilon$ . Emissivity is dependent on a number of factors including the type of material, the material surface, and the radiation wavelength. By measuring the emitted radiation from a body with a known  $\epsilon$ , the surface temperature of the body can be determined. Radiation pyrometers measure this kind of radiation.

For SAS applications, radiation pyrometers offer a several advantages over standard temperature probes, including:

- No contact with the sea (or land) surface is required
- Radiation Pyrometer is not in the FOV of the optical sensors
- Temperature data is integrated and synchronized with the SAS data

The KT 19.85 radiation pyrometer used with the SAS system operates within the spectral wavelength range of 9.6 to 11.5  $\mu\text{m}$ . In this spectral range, the atmospheric transmissivity is very high, minimizing the effects of carbon dioxide and water vapour on the infrared signal strength.

 <b>Operation Manual</b>	SYSTEM <h1 style="text-align: center;">HyperSAS</h1>
	SECTION <h2 style="text-align: center;">A. OVERVIEW</h2>

MDU-100 Deck Unit Power Supply

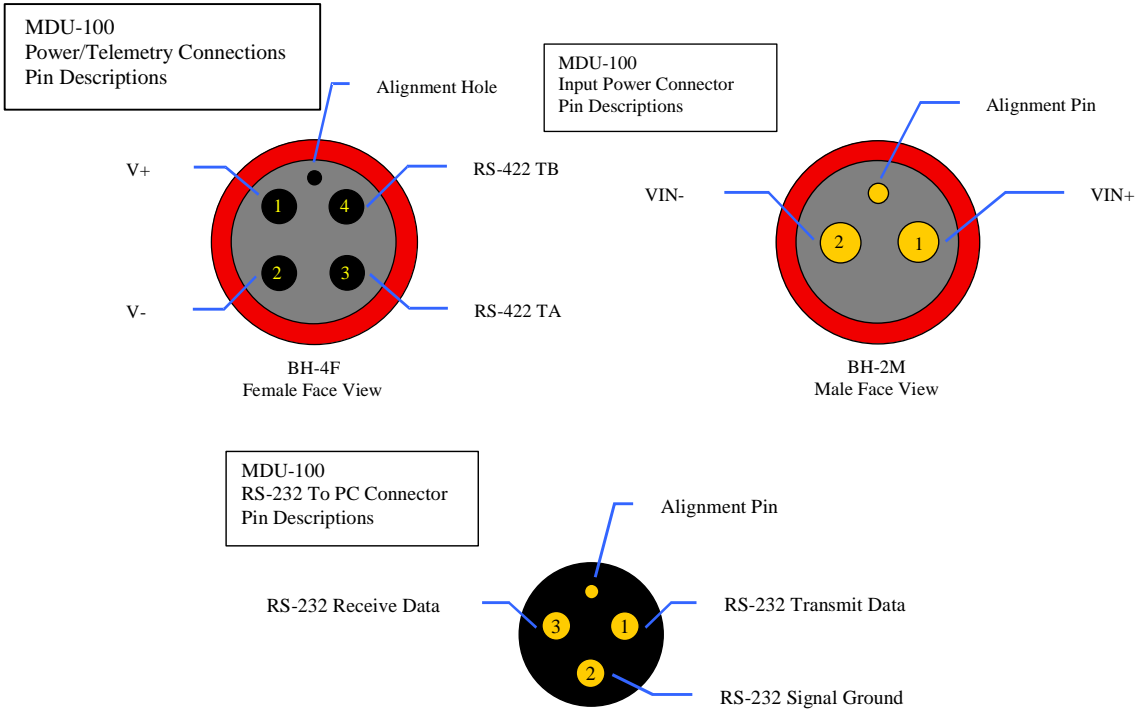
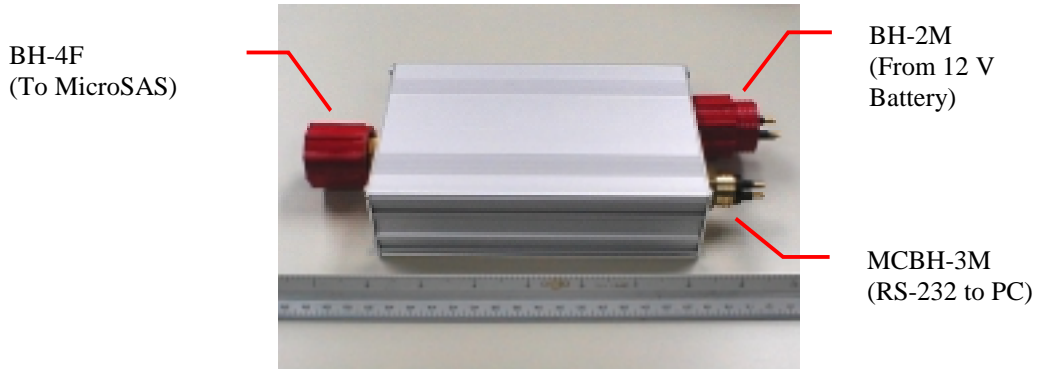

**Figure A-7: MDU-100 Deck Unit**

 <b>Operation Manual</b>	SYSTEM <p style="text-align: center;"><b>HyperSAS</b></p>
	SECTION <p style="text-align: center;"><b>A. OVERVIEW</b></p>

### Deck Unit

The optional *Deck Unit*, a Satlantic MDU-100, serves as both a nominal 48 Volt DC power source for the Network Hub and as a RS-422 to RS-232 level converter. It is connected to the power supply (battery), the network hub, and the computer, through three connectors. Connector details are shown in the figure.

*Refer to Figure A-7, MDU-100 Deck Unit*

### Power Supply

The *Power Supply* for the MDU-100 is normally a battery, but may be any DC power supply in the range of 10-20 Volts at 1 Amp (3 Amp capability is recommended to provide maximum current to the MDU-100). However, in a battery-powered system we recommend using a fairly large battery (i.e. 50 Ah gell cell). This allows a laptop computer to use the same power supply as the HyperSAS.

In systems in which an MDU-100 is not present, the OCR-500 series sensors may be powered directly from a DC source in the range of 6 to 16 VDC.

 <b>Operation Manual</b>	SYSTEM <p style="text-align: center;">HyperSAS</p>
	SECTION <p style="text-align: center;"><b>A. OVERVIEW</b></p>

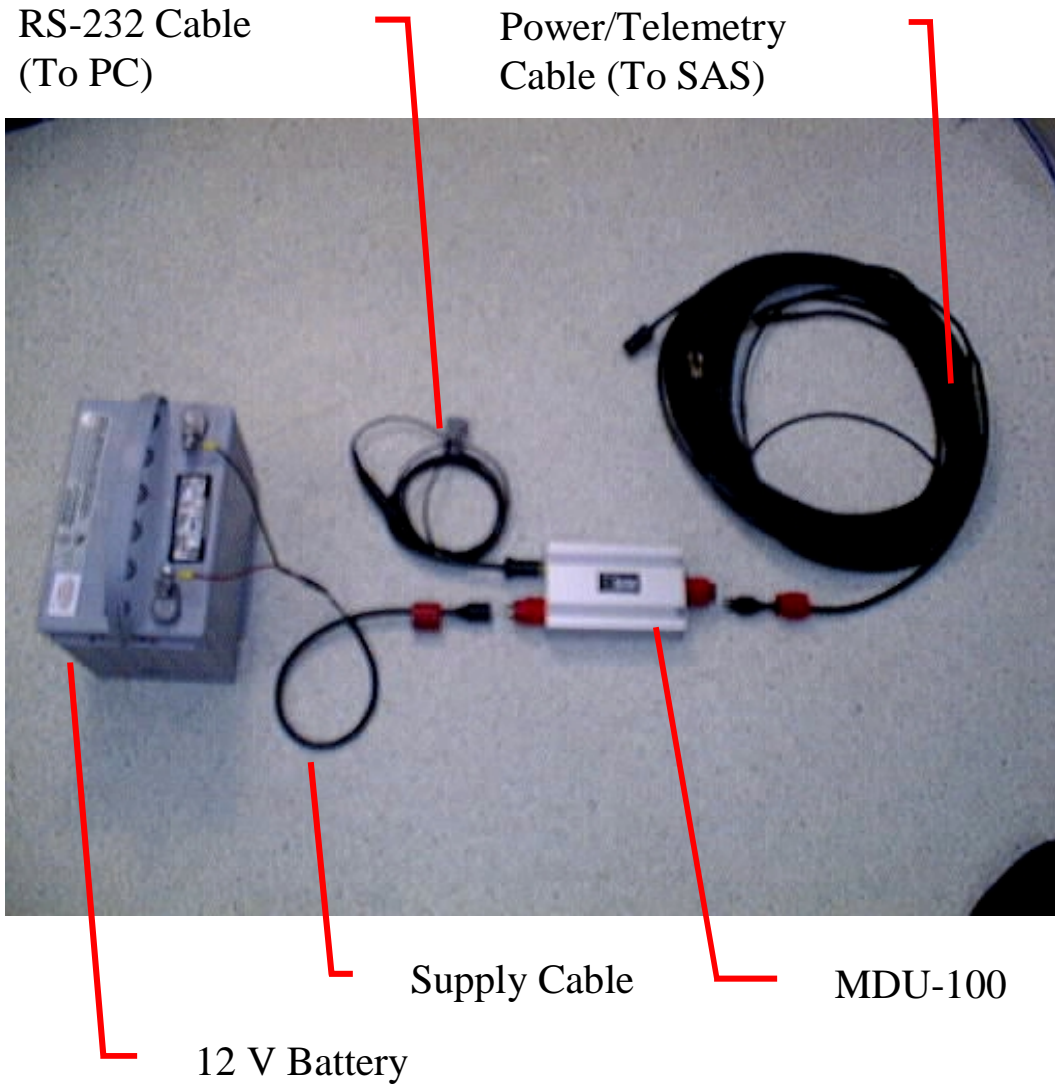

**Figure A-8: System Cables**

 <b>Operation Manual</b>	SYSTEM <h1 style="text-align: center;">HyperSAS</h1>
	SECTION <h2 style="text-align: center;">A. OVERVIEW</h2>

### Cables

In systems with the MDU-100 deck unit, the *Power/telemetry cable* runs from the deck unit to the network hub. In systems where the network hub is not used, a separate power/telemetry cable will be required for each optical sensor, and will connect directly to the battery and PC.

The power/telemetry cable acts as an electrical tether, providing a flexible connection between the power source and the instrument and providing a channel to transport telemetry to the deck unit or logging computer.

The *Supply Cable* or *Battery Cable* runs from the battery to the deck unit.

The *RS-232 Cable* runs from the deck unit to the computer.

The *Interconnect Cables* connect sensors to the network hub housing.

*Refer to Figure A-8, System Cables*

### Logging Computer

The user must supply a computer in order to view and log HyperSAS telemetry. SatView, Satlantic's data logging and display program, should operate on any IBM compatible computer running Windows 95 or 98 with 5 MB of free disk space and a free RS-232 serial port (additional ports may be required depending on system configuration). Additional disk space is required to log data from the HyperSAS - allow several Megabytes. Please refer to the SatView manual for more details.

Please note that SatView **will not** function properly in Windows 2000 or Windows NT.

### GPS Unit



The *GPS unit* normally sold with the HyperSAS system is a Garmin 12XL handheld receiver. This rugged receiver features a parallel twelve-channel receiver for fast satellite acquisition and is powered from four AA alkaline batteries or an external AC adapter. It can be connected to an external antenna if required. A PC interface cable is used to provide RS-232 data directly to the logging computer.

Please refer to the owner's manual for complete device details.



 <b>Operation Manual</b>	SYSTEM	HyperSAS
	SECTION	<b>B. SAFETY &amp; HAZARDS</b>

## **B. SAFETY & HAZARDS**

Please ensure that all users of the HyperSAS have read and understand this section.

### ***Personal Safety***

- The operators should always remain aware of the cable. Any cable or line released from a ship can be dangerous. Keep a safe distance from the cable coil on deck when the instruments are being used.

### ***Power***



- Use extreme care when connecting power supply cables to the instrument. A shorted power supply or battery can output many amperes of current, potentially harming the user or equipment.
- Use extreme care when working with the Heimann radiation pyrometer's AC power supply. Seawater is an excellent conductor of electricity. If the AC supply or power cord becomes wet, the potential for electric shock exists – BE CAREFUL!

### ***Instruments***

- Do not leave instruments in direct sunlight on deck when not in use. Extreme heat (35°C or greater) can potentially damage them.
- When using in-water instruments with the HyperSAS, do not leave the instruments unattended. Boat drift can entangle the cable and cause damage or instrument loss.

### ***Cable***

- Ensure the power/telemetry cable is not pinched or bent to a radius less than 18 cm, to prevent damage to the conductors within the kevlar strength member.

 <b>Operation Manual</b>	SYSTEM	<b>HyperSAS</b>
	SECTION	<b>B. SAFETY &amp; HAZARDS</b>

### ***Connections***

- Handle electrical terminations carefully, as they are not designed to withstand strain. Disconnect the cables from the components by pulling on the connector heads and not the cables. Do not twist the connector while pulling, as this will damage the connector pins.
- Do not use petroleum-based lubricants on connectors. Connectors should be free of dirt and lightly lubricated before mating. We recommend using DC-111 silicone grease (made by Dow-Corning) on the male pins prior to connection.

### ***Troubleshooting***

- While checking voltages with a multimeter, extreme care should be used so as not to short the probe leads. A shorted power supply or battery can output many amperes of current, potentially harming the user, starting fires, or damaging equipment.
- Always ensure power is removed from the device before attempting to perform continuity checks on cables.

### ***Recovery***

- Lens caps should always be replaced on the instruments when not in use. This will help protect the heads from direct damage.
- Always disconnect the power source (i.e. the battery) before disconnecting the power/telemetry cable from the network hub or sensors.
- Be sure to rinse the instrument with fresh water prior to storage. Corrosion resulting from failure to do so is not covered under warranty.

 <b>Operation Manual</b>	SYSTEM	HyperSAS
	SECTION	<b>C. START UP</b>

## C. START UP

### *Assembly Procedure*

If you have any questions about the information presented in this or any other section please feel free to contact Satlantic for further information or clarification. It is important to understand the information and adhere to the guidelines presented in order to ensure successful use of this equipment.

We recommend that you assemble and simulate the deployment of your system before investing time and resources in costly deployments and experiments. This will verify proper functioning of the equipment and ensure that you are familiar with its use.

### Preparation

In preparation for assembly, the HyperSAS components should be checked against the packing list to ensure that all required items are included. The dummy connector and locking sleeve should be stored so that they can be replaced when the instruments are retrieved at the end of the deployment. The instrument packing should be retained and reused to prevent instrument damage during transport.

Lubrication for the male pins on all connectors should be used prior to connection. We recommend DC-111 silicone grease (made by Dow-Corning). **DO NOT** use petroleum-based lubricants.

**Please note that an excess of silicone grease in the sockets of the connectors is an apparent cause of connector failures. The primary problem is the deformation/expansion of the sockets, contacts, and seals. USE A VERY THIN FILM OF THE DC-111 TO AVOID CONNECTOR DAMAGE.**

 <b>Operation Manual</b>	SYSTEM <h2 style="text-align: center;">HyperSAS</h2>
	SECTION <h3 style="text-align: center;">C. START UP</h3>

The user will require a PC with an adequate number of spare communications ports. The number of ports required will depend on the system configuration; for a system using a network hub, only two ports are required (1 for the network hub and 1 for the  $E_S$  sensor), while systems not using the hub will require 4 ports (one each for  $L_T$ ,  $L_i$ ,  $E_S$ , and the temperature sensor). An additional port will be required in each case if a GPS is integrated in the system.

- DC power source (10 – 20V DC for the MDU-100, normally a 12 V battery)
- Data acquisition and processing software compliant with the *Satlantic Data Format Standard*.
- The instruments *calibration file*<sup>3</sup> (provided).

If you are not using your instrument in an embedded system, or you do not have your own data acquisition software, you may use the software provided by Satlantic. Two applications<sup>4</sup>, *SatView* and *SatCon*, are available to you for any PC running Windows® 95/98/NT/2000/XP. Both applications are compliant with the Satlantic Data Format Standard. *SatView* is a data acquisition and real-time display application. *SatCon* is a post processing application for telemetry logged with *SatView*.

Note that it is not necessary to use the software mentioned above to log the instrument telemetry. A properly configured terminal emulator can serve this purpose. However, you will need the proper software to interpret any of the data.

In any case, there are a few standard communications settings needed for any computer application communicating with the instrument. All serial transmissions use 1 start bit, 8 data bits, 1 stop bit, and no parity. No flow control of any kind is used. Make sure that your software is configured with the baud rate specified for your instrument. These settings apply to both the RS-232 and RS-422 telemetry interfaces. For most applications, the default telemetry baud rate is 57600 bps.

<sup>3</sup> For more information on calibration files, refer to the *Instrument File Standard* document available from Satlantic

<sup>4</sup> For more information on these applications, refer to the user's manuals distributed with the software.

<sup>5</sup> Windows is a registered trademark of Microsoft Corporation.

 <b>Operation Manual</b>	SYSTEM	HyperSAS
	SECTION	C. START UP

**IMPORTANT!** Both the RS-232 and RS-422 telemetry interfaces transmit the same information. The RS-232 interface provides bi-directional communication while the RS-422 is transmit-only. Normally, the RS-232 interface is used for configuring and testing your instrument. The RS-422 interface would normally be used for telemetry acquisition in the field using longer cables, such as that found with the HyperSAS. Most computer serial interfaces are RS-232. The MDU-100 deck unit provides the necessary level conversion.

### System Assembly

Please note that the following assembly guide is generic and assumes that all optional components are provided in your system; you may have to adapt the procedures to your particular system.

In a typical SAS system, the following steps are required:

1. Assembling the Mounting Frame
2. Mounting the Radiance Sensors
3. Mounting the Network Hub
4. Mounting the Temperature Sensor
5. Mounting the ES sensor
6. Connecting the Interconnect Cables
7. Powering the System

Please refer to the appropriate sections in the *Operations* for complete details.

### Conduct a Simple Telemetry Test

Before using any instrument in the field, a simple telemetry test should be conducted to ensure that the instrument is functioning properly. This is also a good way to familiarize yourself with the software used with the instrument. The best way to conduct this test is to use SatView with the calibration files provided with your instrument. With the HyperSAS, there will be a calibration file for the network hub (if present) and each slave sensor (OCR-3000) in the system. Setup SatView as described in the manual or on-line help. Next, complete the **Assembly Procedure** described above and ensure that SatView is receiving telemetry.

For a more comprehensive test, you will need to check the instrument status more thoroughly to ensure the telemetry received by SatView is correct. Below are a few guidelines to help you with the test:

- Enable SatView's *Frame Counter* and *Check Sum* error checking to confirm that the data integrity is stable.

 <b>Operation Manual</b>	SYSTEM <p style="text-align: center;"><b>HyperSAS</b></p>
	SECTION <p style="text-align: center;"><b>C. START UP</b></p>

- Look at the spectral output to make sure there are no glaring errors in the data, i.e. unexpected peaks and valleys in the spectrum.
- Look at the spectral output under varying light conditions to make sure the spectrum is adjusting accordingly.
- Log a few minutes of telemetry and process the log file with SatCon. Check for errors in the data and consistency in the optical sensor values.

This test assumes that the instrument(s) you are testing are operating with *free-running* telemetry. This means that telemetry from the system is broadcast on a continuous basis. See section **D- OPERATION** for more information on controlling your instruments telemetry output.

Once you are satisfied that the instrument(s) are working correctly, the next step is to deploy it for fieldwork. Otherwise, if you are experiencing any problems receiving telemetry, see section **G-MAINTENANCE** for information on troubleshooting your instrument. If you are still experiencing problems, contact a Satlantic customer service representative for assistance.

 Operation Manual	SYSTEM	<b>HyperSAS</b>
	SECTION	<b>D-OPERATION</b>

**D. OPERATION**

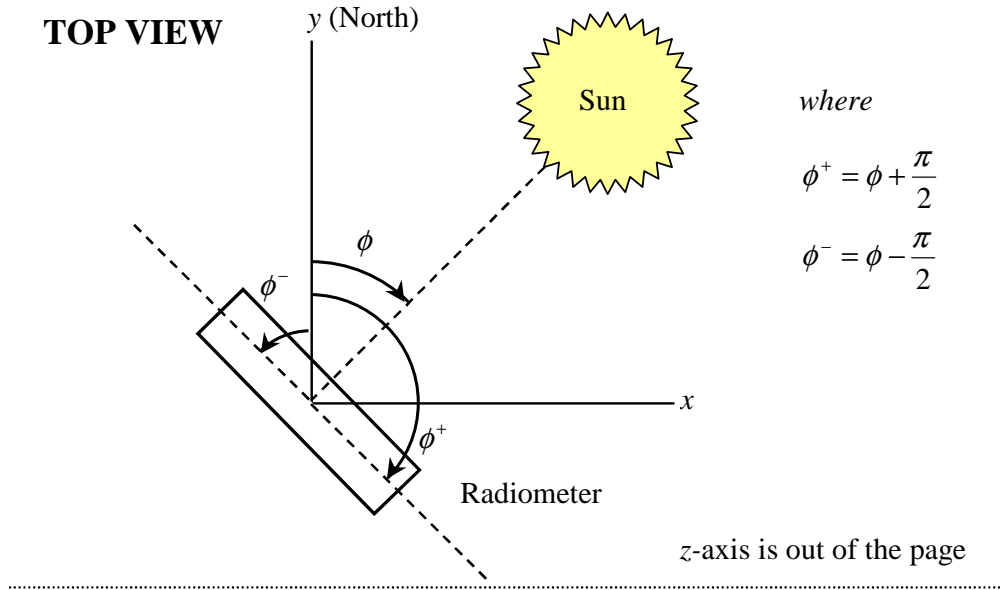

**SIDE VIEW**

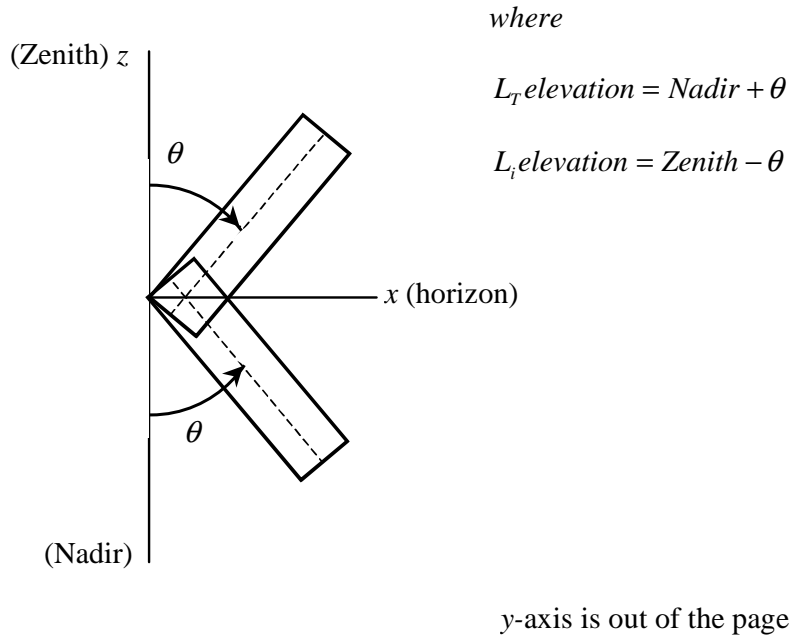

**Figure D-1: SAS Coordinate System**

	SYSTEM	<b>HyperSAS</b>
	SECTION	<b>D-OPERATION</b>

## **Introduction**

The spectral water-leaving radiance,  $L_w$ , is one of the central physical quantities for bio-optical studies in the upper ocean. When measured above the surface, however, the uncertainties associated with the measurements increase. Surface waves introduce fluctuations in the glint and reflected sky light components of the radiance field. The presence of clouds serves to increase the fluctuations and associated uncertainties.

Satlantic's SAS (Surface Acquisition System) instruments allow the measurement of the indirect (sky) radiance and the total radiance above the surface. A separate sensor is used to measure downwelling irradiance. With these quantities known, the water-leaving radiance  $L_w$  can be determined.

## **Fundamentals of SAS Deployments**

Before describing the actual deployment process for the SAS system, several important terms must be defined:

- *Zenith*: the point on the celestial sphere that is vertically above the observer and directly opposite the *nadir*.
- *Nadir*: the point on the celestial sphere that is vertically below the observer and directly opposite the *zenith*.
- *Azimuth*: horizontal direction expressed as the angular distance between the location of a fixed point (such as the ship's heading) and the direction of an object (such as the sun).
- $\phi$  *coordinate*: the solar azimuth angle.
- $\theta$  *coordinate*: the sensor pointing angle with respect to the vertical axis.

*Refer to Figure D-1, SAS Coordinate System*

## **The Effects of Viewing Angles**

The observation geometry is a crucial part of the SAS measurement protocol. The sea and sky radiance sensors must be pointed at the same nadir and zenith angles respectively (see Figure D-1). This angle is usually chosen to be between 30° and 50° with an optimum angle of 40°, as recommended in SeaWiFS protocol (see references on page D-14). At this angle the sea surface reflectance for the skylight does not depend greatly on the wind speed and the constant value of 0.028 can be used in sky glint correction (see data processing section, page D-13). To avoid the direct sun-glint the sensors should be pointed at the azimuth angle between 90° and 180° away from solar plane, with an optimum angle of 135° away from sun. With this orientation the glint effect will be minimized and water-leaving radiance will dominate the total signal.



 Operation Manual	SYSTEM  <p style="text-align: center;"><b>HyperSAS</b></p>
	SECTION  <p style="text-align: center;"><b>D-OPERATION</b></p>

In the case of airborne deployment, the  $L_T$  sensor should point at nadir (straight down) while the  $L_i$  sensor (if available) should point at zenith (straight up). This observation geometry is the most appropriate for the rapidly changing orientation of the flying aircraft.

### Airborne Measurements

Ocean color can be measured from aircraft using Satlantic's SAS instruments. The advantage of airborne remote sensing is that it provides rapid monitoring of ocean color along the aircraft's linear track. For airborne applications the sky radiance sensor  $L_i$  is commonly not used, and the SAS system consists usually of  $L_T$  and  $E_s$  sensors only. The  $L_T$  sensor should point at nadir (straight down) while the  $L_i$  sensor (if available) should point at zenith (straight up). The  $L_T$  signal recorded from the aircraft contains the contribution from atmospheric scattering in addition to the surface signal. For altitudes higher than 300 m, the atmospheric corrections should be applied.

 Operation Manual	SYSTEM	<b>HyperSAS</b>
	SECTION	<b>D-OPERATION</b>

## Shipboard Measurements

Ship-mounted SAS instruments have the advantage of making measurements close to the sea surface. Corrections are not required for atmospheric transmission and path radiance, although corrections are required for light reflected from the sea surface. An  $E_s$  sensor is required to normalize the results.

The bow of the ship is normally considered to be the best position for the SAS system, as it will minimize errors from shading and reflection due to the ship. When the ship is moving, making radiance measurements from the bow will ensure that the water is undisturbed by the ship's wake. Sea foam and floating objects must be out of the viewing area of the radiance sensor. The irradiance sensor should be mounted in a location high on the ship to minimize shading and reflection effects.

To measure sea-surface radiance, the  $L_T$  sensor should point to the sea surface at an angle  $\theta$  of about  $40^\circ$  from Nadir, and at a right angle to the sun (i.e.  $\pm 90^\circ$  from the sun's azimuth  $\phi$ ). The proper azimuthal angle is easily determined using the azimuthal band located on the rotary pedestal. The  $L_i$  sensor must point at an identical azimuth angle (guaranteed by the SAS frame), and **must** be at the same angle from the Zenith as the  $L_T$  sensor is from Nadir. Refer to Figure D-1 for details. Please note that the SAS frame allows the elevations for both radiance sensors to be adjusted; this allows researchers to investigate the effects of  $\theta$  on the measurements.

Some researchers will prefer to estimate  $E_s$  using the plaque method instead of directly measuring it with a separate sensor. In the plaque method, a gray plaque is placed in front of the surface-viewing sensor. Satlantic's SAS frame easily adapts to this method. The frame is designed to accommodate a 25 cm (10 inch) gray Spectralon™ plaque from Labsphere, Inc. The plaque normally used is an SRT-10-100 with a nominal 10% reflectance. This reflectance value permits radiometers with typical above-water saturation values to make the measurement without saturating the detectors.

The contribution of surface glint to the  $L_T$  measurement can be determined from the sky radiance sensor. Refer to *the Fundamentals of SAS Data Processing* section for details.

	SYSTEM	<b>HyperSAS</b>
	SECTION	<b>D-OPERATION</b>

### ***Fundamentals of SAS Data Processing***

The total signal received by the sensor pointed to the sea surface  $L_t$  contains contributions from surface reflection in addition to the water-leaving radiance and can be written as:

$$L_t(\lambda, \theta, \phi) = L_{sky-g}(\lambda, \theta, \phi) + L_{sun-g}(\lambda, \theta, \phi) + L_w(\lambda, \theta, \phi)$$

Where  $L_t$  is total sea surface radiance,  $L_{sky-g}$  is sky-glint radiance (i.e. reflection of the skylight from the sea surface),  $L_{sun-g}$  is sun-glint radiance and  $L_w$  is water-leaving radiance.

In order to retrieve spectral water-leaving radiance from the total signal, these unwanted contributions (sun- and sky-glint) have to be quantified and removed from the spectra. This process is called sun- and sky-glint correction.

Satlantic currently does not provide a software package for computing water-leaving radiance from SAS data. The release of ProSoft for SAS applications is expected in December 2002. At present the choice of correction algorithms is left to the customer. However, we provide here some remarks on fundamentals of SAS processing as well as list of references describing the correction algorithms. The following are the steps required for the computation of water-leaving radiance from SAS data.

1. Data Calibration: The raw data should be processed to calibrated units using Satlantic software packages (SatCon or Prosoft).
2. Sun Glint Removal: Before calculating the mean value of total sea surface radiance, the  $L_t$  data should be filtered to remove sun-glint outliers. The filtering method described in the SeaWiFS protocol (ref 3) recommends removing all the values that are greater than 1.5 standard deviations from the mean. Recent studies have shown that the best results are obtained if only the lowest 5% data are accepted (ref 2).
3. Correction for Sky Glint: Once the sun-glint is removed the sea surface signal still contains the contribution from the skylight reflected from the sea surface. At present there are number of methods for sky-glint correction designed for clear or cloudy sky, Case I or Case II water (described in the references). The simplest method for sky-glint estimation uses Fresnel reflectance and sky radiance data, where the sky-glint is expressed as:

$$L_{sky-g}(\lambda, \theta, \phi) = \rho(\theta)L_t(\lambda, \theta, \phi)$$

 Operation Manual	SYSTEM	<b>HyperSAS</b>
	SECTION	<b>D-OPERATION</b>

where  $\rho$  is sea surface reflectance at the angle  $\theta$ , and  $L_i$  is sky radiance (obtained from SAS sky sensor). If the pointing angle is  $40^\circ$  from vertical the recommended sea surface reflectance value is  $\rho(\theta)=0.028$ . This value also varies with wind speed (see ref 3).

In the case of airborne data the sky sensor is usually not deployed and the sky-glint correction is frequently not applied at all. The water-leaving radiance is commonly obtained only by applying sun-glint filter to the calibrated data (steps 1 and 2). For higher flight altitudes (more than 300m) the  $L_t$  signal contains contribution from atmospheric scattering in addition to the surface signal and in this case the appropriate atmospheric correction should be applied.

#### References:

1. Hooker S.B., Zibordi G., Lazin G., and S. McLean, The SeaBOARR-98 Field Campaign, SeaWiFS Postlaunch Technical Report Series, NASA TM-1999-206892, Vol. 3, 1999

Available at: [http://seawifs.gsfc.nasa.gov/seawifs\\_scripts/postlaunch\\_tech\\_memo.pl](http://seawifs.gsfc.nasa.gov/seawifs_scripts/postlaunch_tech_memo.pl)

2. Hooker S.B., Lazin G., Zibordi G., and S. McLean, An Evaluation of above- and in-water methods for determining water-leaving radiance, J. Atmos. Oceanic Technol., 19, 486-515, 2002

3. Fargion G.S., and J.L. Muller, Ocean optics protocols for satellite ocean color sensor validation, revision2, NASA TM-2000-209966, GSFC, 2000

Available at: <http://seabass.gsfc.nasa.gov/docs/SIMBIOS-OOPR2.pdf>

 Operation Manual	SYSTEM	<b>HyperSAS</b>
	SECTION	<b>D-OPERATION</b>

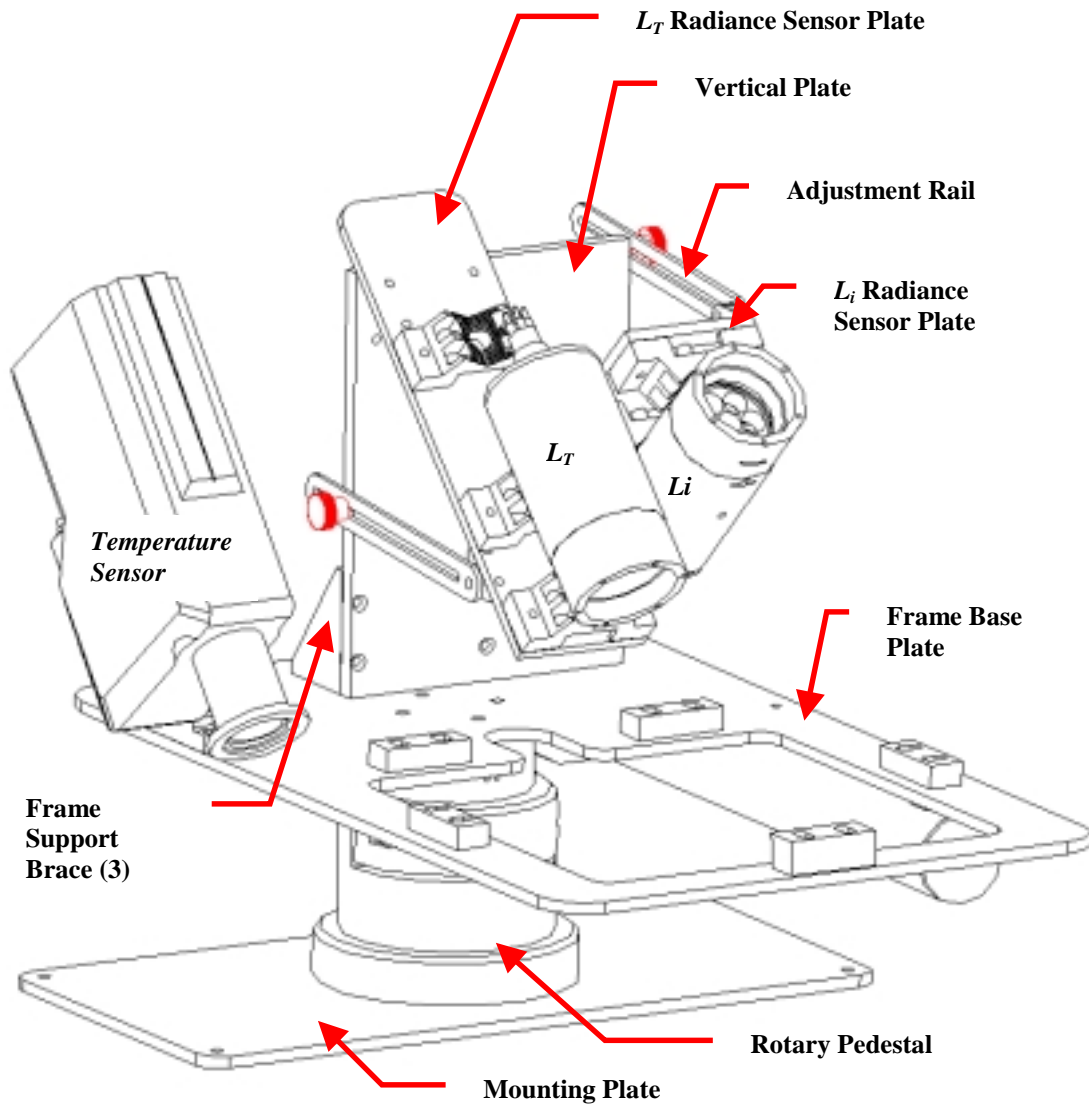

**Figure D-2: The Assembled SAS System**

	SYSTEM	<b>HyperSAS</b>
	SECTION	<b>D-OPERATION</b>

## **System Assembly**

Please note that the following assembly guide is generic and assumes that all optional components are provided in your system; you may have to adapt the procedures to your particular system.

In a typical SAS system, the following steps are required:

1. Assembling the Mounting Frame
2. Mounting the Radiance Sensors
3. Mounting the Network Hub
4. Mounting the Temperature Sensor
5. Mounting the ES sensor
6. Connecting the Interconnect Cables
7. Powering the System

*Please refer to Figure D-2, The Assembled SAS System.*

Note that in the following discussion and diagrams, a SAS system using Satlantic OCR-507 sensors is used. Setup using OCR-3000 series instruments is similar.

### **Assembling the SAS Mounting Frame**

The SAS frame normally is shipped in several pieces to reduce the size of the shipping crate, and must be assembled by the user before deployment. Assembly is quite straightforward; the final result is shown in Figure D-2. Use the following general procedure:

1. Attach the Rotary Pedestal to the 16 inch by 8 inch Mounting Plate, using four 10-32 screws (provided). Note that the mounting plate should be mounted to the ship using the 1/4-20 holes in each corner of the plate.
2. Attach the three right angle Frame Support Braces to the Vertical Plate, using six 10-32 screws.
3. Attach the  $L_r$  Radiance Sensor Plate to the Vertical Plate.
4. Attach the  $L_T$  Radiance Sensor Plate to the Vertical Plate.
5. Attach the Adjustment Rails to each Sensor Plate.
6. Attach the Vertical Plate to the Frame Base Plate.
7. Attach the Pyrometer Mount to the Frame Base Plate (the mount can be seen in Figure A-4).
8. Attach the Frame Base Plate to the Pedestal using the four 10-32 screws.
9. Attach the Pyrometer Mount Plate to the temperature sensor using two M8 screws.
10. Attach the temperature sensor with the attached mounting plate to the frame using three 10-32 screws.

 Operation Manual	SYSTEM <p style="text-align: center;"><b>HyperSAS</b></p>
	SECTION <p style="text-align: center;"><b>D-OPERATION</b></p>

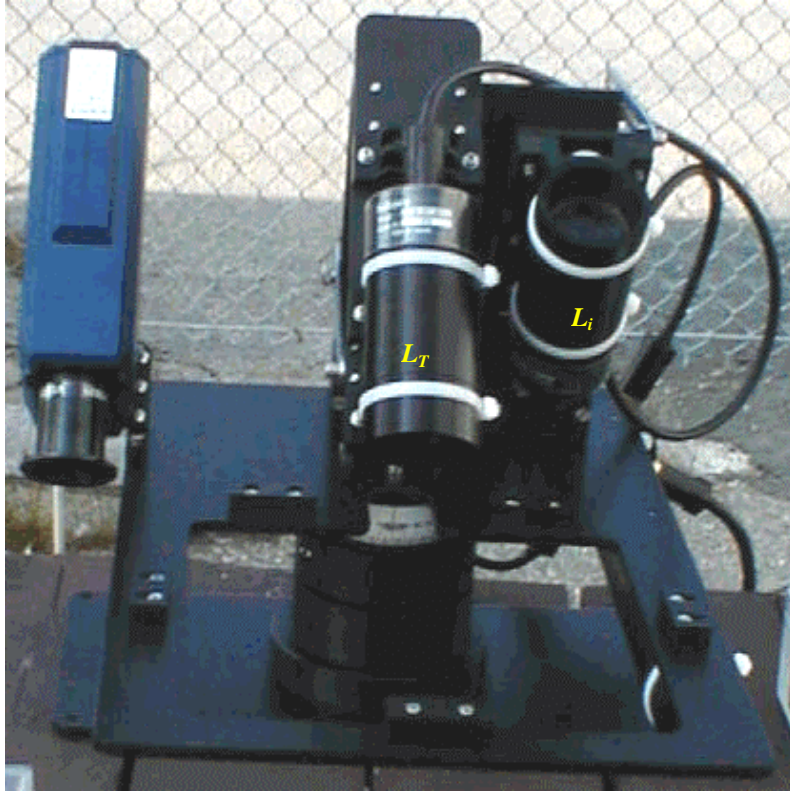

**Figure D-3: Mounted Radiance Sensors**

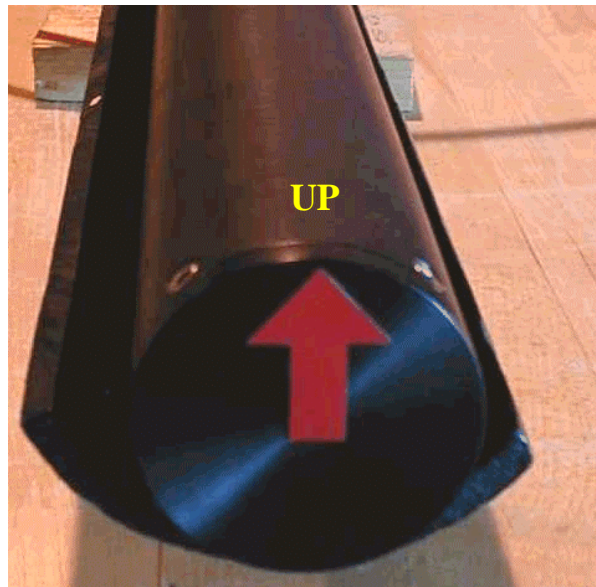

**Figure D-4: Network Hub Up Arrow**

 Operation Manual	SYSTEM	<b>HyperSAS</b>
	SECTION	<b>D-OPERATION</b>

### Mounting the $L_i$ Sensor

The sky radiance sensor is mounted to the KWIK BLOCK™ plastic V-shaped mounting blocks using several cable ties. The cable ties must be very tight to prevent any slipping of the radiance sensor. **Remember to mount the sensor with the drainage hole pointing down! Moisture on the radiance faceplate will adversely affect sky radiance measurements!**

*Refer to Figure D-3, Mounted Radiance Sensors*

### Mounting the $L_T$ Sensor

The sea-surface radiance sensor is mounted to the KWIK BLOCK™ plastic V-shaped mounting blocks using several cable ties. The cable ties must be very tight to prevent any slipping of the radiance sensor.

*Refer to Figure D-3, Mounted Radiance Sensors*

### Mounting the Temperature Sensor

The temperature sensor is mounted to the SAS frame as described in the assembly of the SAS mounting frame. After mounting the sensor, the pyrometer cable (gray or white in colour) should be connected to the sensor. Next, we advise covering the temperature sensor in plastic (such as a plastic grocery bag), leaving only the lens portion exposed. All edges of the plastic should be well taped. This helps prevent the possibility of water damage to the camera due to sea spray, rain, etc.

### Mounting the Network Hub

The Network hub is mounted to the SAS frame using several cable ties, similar to the radiance sensors. **In systems with a pitch-and-roll tilt sensor, the hub must be mounted with the red arrow labels pointing up. If this is not done, the values obtained for the pitch and roll angles will be invalid.**

*Refer to Figure D-4, Network Hub Up Arrow*

### Mounting the $E_S$ Sensor

Normally, the irradiance sensor is provided with a small plastic mounting plate with KWIK BLOCK™ V-blocks for mounting to a pole with cable ties. The sensor should be mounted as high on the ship as possible to minimize the effects due to reflections and shading.



 Operation Manual	SYSTEM	HyperSAS
	SECTION	D-OPERATION

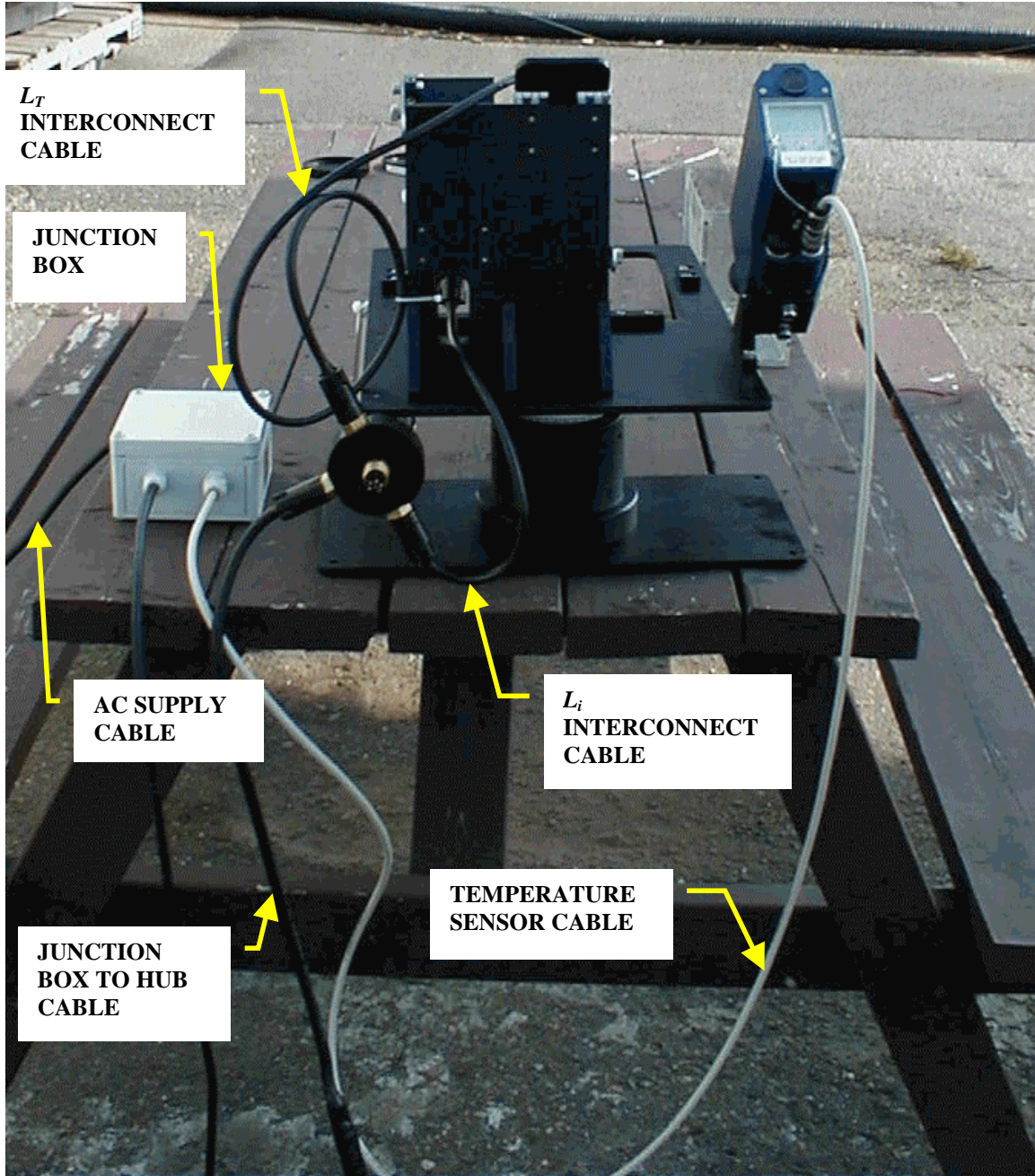



Figure D-5: Interconnect Cables

 Operation Manual	SYSTEM	<b>HyperSAS</b>
	SECTION	<b>D-OPERATION</b>

## Connecting the Interconnect Cables

After mounting all components to the frame, the interconnect cables may be attached to the various components. The connections will depend on whether or not a network hub is present.

### **When using a Network Hub:**

*Please refer to Figure D-5, Interconnect Cables*

1. Ensure that AC power is not being supplied to the junction box.
2. Ensure that the deck unit is not connected to a battery or other power source.
3. Connect one of the six-pin 16 inch interconnect cables to the  $L_T$  sensor. Connect the male end of the interconnect cable to one of the six-pin female connectors on the network hub. Tighten both locking sleeves.
4. Connect the other six-pin 16 inch interconnect cable to the  $L_i$  sensor. Connect the male end of the interconnect cable to the remaining six-pin female connector on the network hub. Tighten both locking sleeves.
5. If not already done, connect the gray or white temperature sensor cable from the junction box to the temperature sensor.
6. Connect the 4 pin male cable from the junction box to the 4-pin female bulkhead connector on the hub body. Tighten the locking sleeve.
7. **DO NOT APPLY POWER TO THE JUNCTION BOX AT THIS TIME! Doing so could damage the network hub!**
8. Wrap the junction box in plastic (i.e. a plastic grocery bag. While the enclosure is NEMA rated and should not leak if splashed with water, the plastic will help keep water off of it.

### **WARNING!**

**AC POWER WILL BE PRESENT IN THE JUNCTION BOX! DO NOT ALLOW THE BOX TO BECOME WET, AS THIS WILL CREATE AN ELECTRICAL SHOCK HAZARD!**

9. Connect the power/telemetry to the MDU-100 and Network Hub. Connect the two pin cable to the MDU-100, but **DO NOT APPLY POWER AT THIS TIME!**
10. Connect the RS-232 cable from the MDU-100 to a spare communications port on the logging computer
11. Connect the 6-pin power/telemetry connector to the  $E_S$  sensor. This cable is normally 20 meters long, and is easily recognizable as it contains a splice with a female DB9 connector and either battery clips or banana jacks. Do not apply power to the cable at this time.

 Operation Manual	SYSTEM	<b>HyperSAS</b>
	SECTION	<b>D-OPERATION</b>

**When NOT using a Network Hub:**

1. Ensure that AC power is not being supplied to the temperature sensor junction box.
2. Ensure that power is not being applied to any of the power/telemetry cables.
3. Connect one of the power/telemetry cables to the  $E_S$  sensor. Tighten the locking sleeve. Connect the attached DB9 to a spare communications port on the logging computer. **Do not apply power at this time.**
4. Repeat step 3 for the  $L_i$  sensor.
5. Repeat step 3 for the  $L_T$  sensor.
6. If not already done, connect the gray or white temperature sensor cable from the junction box to the temperature sensor.
7. Connect the RS-232 telemetry cable from the junction box to a spare communications port on the logging computer.
8. **DO NOT APPLY POWER TO THE JUNCTION BOX AT THIS TIME!**
9. Wrap the junction box in plastic (i.e. a plastic grocery bag. While the enclosure is NEMA rated and should not leak if splashed with water, the plastic will help keep water off of it.

**WARNING!**

**AC POWER WILL BE PRESENT IN THE JUNCTION BOX! DO NOT ALLOW THE BOX TO BECOME WET, AS THIS WILL CREATE AN ELECTRICAL SHOCK HAZARD!**

Powering the System

After connecting all the system cables as outlined in the previous section, the various devices can have power applied. Before applying power, you may wish to set up the logging computer with SatView, although this is not required.

**When using a Network Hub:**

1. Apply power (normally a 12 V battery) to the MDU-100
2. Apply AC power to the temperature sensor junction box power cord.
3. Apply power (normally a 12 V battery) to the  $E_S$  sensor.

**When NOT using a Network Hub:**

1. Apply power (normally a 12 V battery) to the  $E_S$  sensor's power-telemetry cable.
2. Apply power (normally a 12 V battery) to the  $L_T$  sensor's power-telemetry cable.
3. Apply power (normally a 12 V battery) to the  $L_i$  sensor's power-telemetry cable.
4. Apply AC power to the temperature sensor junction box power cord.

	SYSTEM	HyperSAS
	SECTION	D-OPERATION

## Network Hub Operating Modes

**Note: This section assumes a network hub is present. Please refer to the separate OCR-3000 manual(s) for sensor operating modes.**

The HyperSAS network hub can operate in one of three primary operating modes – Autonomous, Network, or Network Master Operation. These operating modes are collectively called *normal operation* and are described in detail below. The instruments configuration and physical environment determine which mode the instrument will operate in. **In most circumstances, the HyperSAS network hub will be configured for Network Master operation.** This is done during the initialization sequence, which begins immediately after power is applied to the instrument. Once the initialization sequence completes, normal operation begins. This will continue until power is removed or the instrument is reset.

**IMPORTANT! This section goes into detail about the SatNet aspect of the HyperSAS, and is intended for advanced users only. Most users will not require any knowledge of this system, as the instrument is essentially a “plug and play” device when used with SatView. Changing any parameters will affect system operation – please discuss any changes with a Satlantic representative before modifying these settings.**

## Initialization Sequence

Once power is applied to the HyperSAS, the instrument begins a four-second window of operation called the initialization sequence. During this time, the on-board electronics are powered up, checked, and readied for operation. If the *silent mode configuration parameter*<sup>6</sup> is disabled, a start-up banner will be output on the telemetry interface, similar to the one shown below:

```
Satlantic MicroPro Profiler
Copyright (C) 2002, Satlantic Inc. All rights reserved.
Firmware version: 1.2A(P), 2.1A(S) - SatNet Type A
Instrument: SATMPR
S/N: 0000

Reset Source: Power
Press <Ctrl+C> for command console.
Initializing system. Please wait...
```

This banner is a simple text message that can be viewed in a terminal emulator. See section **E CONFIGURATION** for more information on

<sup>6</sup> Configuration parameters are discussed in detail in section **E CONFIGURATION**.

	SYSTEM	<b>HyperSAS</b>
	SECTION	<b>D-OPERATION</b>

setting up a terminal emulator to monitor output from the telemetry interface.

The first section of the banner identifies the instrument. Specifically, the first line identifies the instrument type. The firmware (or microcontroller software) version is identified on the third line. This line also defines the SatNet compliance used by the instrument. *Type A* compliance uses a dual processor control system capable of operating as a Network Master. *Type B* compliance is a smaller, single processor system without Network Master capabilities. The next two lines define the instrument type identifier and serial number used at the beginning of a telemetry frame. See the **Telemetry Format** section below for more information on the instruments telemetry frames.

The next section of the banner gives additional information related to the initialization sequence. The first line identifies the mode in which the system was initialized. *Power* indicates that the instrument began operation after power was applied. *Software* indicates that a *reset* command was issued to the instrument to reboot itself. *External* may mean that a brown out (or brief interruption in power input) occurred and the processor reset itself.

The next line of this section gives instructions on how to access the **Command Console**. In most cases, the command console would be accessed during normal operation. If this is done during the initialization sequence, the instrument will be forced into autonomous operation before the console is displayed. This gives the ability to break into the command console even if the instrument is configured to run in a network. Note that the command console is not displayed until the initialization sequence completes. See section **E CONFIGURATION** for more information on accessing and using the command console.

Once the initialization sequence has finished, normal operation begins. If silent mode is disabled, one of the following messages will be output, depending on which operating mode is enabled.

Autonomous operation enabled.

or

Network operation enabled.

or

Network Master operation enabled.

### **Autonomous Operation**

Autonomous, or stand-alone, operation for the HyperSAS network hub is defined as the continuous operation of the instrument outside the scope of a network. This mode of operation is not normally used with the

	SYSTEM	<b>HyperSAS</b>
	SECTION	<b>D-OPERATION</b>

HyperSAS. Autonomous operation uses only the telemetry interface for communication and telemetry output. The network interface is disabled.

During autonomous operation, the default behavior of the instrument is to continually sample its ancillary sensors and output telemetry on the RS-232 and RS-422 telemetry interfaces. When the instrument is used in the field, this telemetry would be collected and saved to a storage medium. Generally, a data acquisition application like SatView would be used. If you are using your HyperSAS in an embedded system, another mode of telemetry acquisition may be more appropriate. When telemetry output is free-running, as described above, no user input is required to operate the instrument.

However, telemetry output can also be controlled with simple commands sent to the instrument through the telemetry interface. As this involves two-way communication, only the RS-232 telemetry interface can be used. These commands are simple one-byte transmissions. In an embedded or larger scale system, the data acquisition software could use this feature to finely control telemetry output and instrument operation. These commands can also be sent directly by the user with a terminal emulation program, as discussed in section **E CONFIGURATION**.

The following table defines these command bytes and their affect on the instrument. All commands, which are standard with all SatNet compliant instruments, are ASCII control characters. They are not echoed back so if you are using a terminal emulator to send these commands, you will not see any command values on the screen. For example, in a terminal emulation program, you would use the <Ctrl+C> command to access the command console. To do this, press and hold the Ctrl key followed by the C key. This is the same as sending the hexadecimal equivalent byte "03" to the instrument over the telemetry interface. This number is also indicated in the table.

Command	Hex	Description
<Ctrl+C>	03	This command interrupts normal operation of the instrument and invokes the <b>Command Console</b> . See section <b>E CONFIGURATION</b> for more information.
<Ctrl+S>	13	This command stops <i>free-running</i> telemetry output, enabling <i>polled</i> telemetry output.
<Enter> or <SPACE>	0D or 20	If the instrument is running with <i>polled</i> telemetry output, either of these commands will force the instrument to sample its sensors and return a telemetry frame.

 Operation Manual	SYSTEM	<b>HyperSAS</b>
	SECTION	<b>D-OPERATION</b>

<Ctrl+A>	01	This command stops <i>polled</i> telemetry output, enabling <i>free-running</i> telemetry output.
<Ctrl+P>	10	This command powers down the operational components of the instrument. This may reduce the instruments total power consumption, as any electronics associated with sensor operation will be turned off, if possible. The instrument is otherwise fully operational, so communication is still possible. When operational components are powered down, telemetry output is disabled, regardless of the telemetry output mode.
<Ctrl+U>	15	This command returns power to the operational components of the instrument if they were previously powered down. Telemetry output will resume based on the current telemetry output mode.
<Ctrl+R>	12	This command forces the instrument to reset itself. After a few seconds, the instrument will reboot and the initialization sequence will begin again.

With the exception of the <ENTER> and <SPACE> commands, repeatedly sending a command will have no effect. For example, you cannot power down operational components more than once.

The free-running and polled telemetry output modes described above are sub-modes of normal operation. When the instrument is free-running, telemetry frames are output from the instrument according to the *maximum frame rate* configuration parameter.

### **Network Operation**

Network operation for the HyperSAS network hub is defined as continuous operation of the instrument within the scope of a SatNet network. Furthermore, standard network operation means that the instrument is **not** operating as a Network Master device. While operating in this mode, only the network interface is used for communication. The telemetry interface is disabled.

To enable network operation, a number of criteria must be met; otherwise operation will default to running autonomously. First, the *network mode* configuration parameter must be enabled. Secondly, the network interface pins, NA and NB, must be physically connected to another SatNet instrument operating as a Network Master device. These first two conditions will ensure that network operation is invoked. However, to ensure proper operation of the network, additional criteria must be adhered to. Namely, the *network baud rate* configuration parameter must be set to the same baud rate as the Network Master. Finally, the *network*

	SYSTEM	<b>HyperSAS</b>
	SECTION	<b>D-OPERATION</b>

*address* configuration parameter must be unique to all other instruments in the network.

During network operation, the HyperSAS is completely controlled by the Network Master. All communication is relayed through the network between the Network Master and the other instruments running in network operation mode. Instead of sending a telemetry frame through the telemetry interface, as is done in autonomous operation, each instrument sends its telemetry through the network interface to the Network Master. The Network Master then channels the telemetry through its telemetry interface where it can be collected by a data acquisition system.

The only way to gain control access of an instrument running in network operation mode is through the telemetry interface of the Network Master. A Network Master has a set of commands for controlling telemetry similar to that of an instrument running autonomously. These commands can also control other instruments in the network. For more information on the Network Master and its operational command structure, refer to the operating manual of your Network Master device.

### ***Network Master Operation***

Network Master operation for the HyperSAS is defined as the continuous operation of the instrument within the scope of a SatNet network, acting as the Network Master. When operating in this mode, the instrument uses the network interface to obtain data from the slave devices and outputs the information, together with its own data, on the telemetry interface. This is the default operation mode for the HyperSAS hub.

To enable Network Master operation, a number of criteria must be met. First, the *network mode* configuration parameter must be enabled. Secondly, the network interface pins, NA and NB, must be physically connected to other SatNet instruments operating as a Network Slave devices – there can be only one Network Master in a SatNet configuration. In addition, the *network master mode* parameter must be enabled. Finally, the *master network* bias parameter must be enabled. These conditions will ensure that network master operation is invoked. However, to ensure proper operation of the network, additional criteria must be adhered to. Namely, the *network baud rate* configuration parameter must be set to the same baud rate as the rest of the network instruments. Also, the *network address* configuration parameter must be unique to all other instruments in the network.

During network master operation, the HyperSAS network hub completely controls the Network Slave devices. All communication is relayed through the network between the Network Master and the other instruments



 Operation Manual	SYSTEM	<b>HyperSAS</b>
	SECTION	<b>D-OPERATION</b>

running in network operation mode. Instead of sending a telemetry frame through the telemetry interface, as is done in autonomous operation, each instrument sends its telemetry through the network interface to the Network Master. The Network Master then channels the telemetry through its telemetry interface where it can be collected by a data acquisition system (such as SatView).

As in autonomous mode, telemetry output can be controlled with simple commands sent to the instrument through the telemetry interface. As this involves two-way communication, only the RS-232 telemetry interface can be used. These commands are simple one-byte transmissions. In an embedded or larger scale system, the data acquisition software could use this feature to finely control telemetry output and instrument operation. These commands can also be sent directly by the user with a terminal emulation program, as discussed in section **E CONFIGURATION**.

The following table defines these command bytes and their affect on the instrument. All commands, which are standard with all SatNet compliant instruments, are ASCII control characters. They are not echoed back so if you are using a terminal emulator to send these commands, you will not see any command values on the screen. For example, in a terminal emulation program, you would use the <Ctrl+C> command to access the command console. To do this, press and hold the Ctrl key followed by the C key. This is the same as sending the hexadecimal equivalent byte "03" to the instrument over the telemetry interface. This number is also indicated in the table.

Command	Hex	Description
<Ctrl+C>	03	This command interrupts normal operation of the instrument and invokes the <b>Command Console</b> . See section <b>E CONFIGURATION</b> for more information.
<Ctrl+S>	13	This command stops <i>free-running</i> telemetry output, enabling <i>polled</i> telemetry output.
<Enter> or <SPACE>	0D or 20	If the instrument is running with <i>polled</i> telemetry output, either of these commands will force the instrument to sample its sensors and return a telemetry frame.
<Ctrl+A>	01	This command stops <i>polled</i> telemetry output, enabling <i>free-running</i> telemetry output.

 Operation Manual	SYSTEM	<b>HyperSAS</b>
	SECTION	<b>D-OPERATION</b>

<Ctrl+P>	10	This command powers down the operational components of the instrument. This may reduce the instruments total power consumption, as any electronics associated with sensor operation will be turned off, if possible. The instrument is otherwise fully operational, so communication is still possible. When operational components are powered down, telemetry output is disabled, regardless of the telemetry output mode.
<Ctrl+U>	15	This command returns power to the operational components of the instrument if they were previously powered down. Telemetry output will resume based on the current telemetry output mode.
<Ctrl+R>	12	This command forces the instrument to reset itself. After a few seconds, the instrument will reboot and the initialization sequence will begin again.
<Ctrl+N>	0E	This command is only available to the network master. After enabling polled telemetry, issuing this command followed by a valid network address allows the user to poll the slave device at that address. Press <Ctrl+N> to return to the master device.

With the exception of the <ENTER> and <SPACE> commands, repeatedly sending a command will have no effect. For example, you cannot power down operational components more than once.

The free-running and polled telemetry output modes described above are sub-modes of normal operation. When the instrument is free-running, telemetry frames are output from the instrument according to the *maximum frame rate* configuration parameter

	SYSTEM	<b>HyperSAS</b>
	SECTION	<b>D-OPERATION</b>

### **Telemetry Format**

The telemetry format for the HyperSAS network hub, as with all Satlantic instrumentation, follows the Satlantic Data Format Standard. This standard defines how Satlantic telemetry can be generated and interpreted. For every sample taken of the instruments sensors, the instrument will compose and transmit one frame of telemetry containing all the relevant sensor information for that sample. The format is the same regardless of the operating mode. The HyperSAS network hub generates a frame of telemetry with the following components:

<b>Field Name</b>	<b>Field Size (bytes)</b>	<b>Description</b>
Instrument	1 - 10	An AS formatted string denoting the start of a frame of telemetry. The sequence normally starts with "SAT" for a Satlantic instrument. The next series of characters would identify the type of instrument (or telemetry). This is normally a six-character field.  For the HyperSAS, the string will be SATMPR
Serial Number	1 - 10	An AS/AI formatted string denoting the serial number of the instrument. This field combined with the INSTRUMENT field uniquely identifies the instrument. This combination is known as the frame header or synchronization string. This is normally a four-character field.
SV Sense	2	This field contains a BU formatted value indicating the regulated input voltage.
VA Sense	2	This field contains a BU formatted value indicating the analog rail voltage for the operational components of the instrument.
V15 Sense	2	This field contains a BU formatted value indicating the analog rail voltage for the pressure sensor (+15V nominal).
Int. Temp.	2	This field contains a BU formatted value indicating the internal temperature of the instrument.
AUX1	2	This field contains a BU formatted value for a spare ADC channel.

 Operation Manual	SYSTEM	<b>HyperSAS</b>
	SECTION	<b>D-OPERATION</b>

AUX2	2	This field contains a BU formatted value for a spare ADC channel.
AUX3	2	This field contains a BU formatted value for a spare ADC channel.
Pressure	2	This field contains a BU formatted value indicating the pressure sensor reading.
Tilt X	2	This field contains a BU formatted value indicating the instruments tilt in the X direction.
Tilt Y	2	This field contains a BU formatted value indicating the instruments tilt in the Y direction.
Temp Tilt	2	This field contains a BU formatted value indicating the value of the temperature of the tilt sensor. This sensor is not calibrated.
Tw	2	This field contains a BU formatted value indicating the water temperature from the external temperature sensor.
FRAME COUNTER	1	A BU formatted data integrity sensor that maintains a count of each frame transmitted. The count increments by one for each frame transmitted from 0 to 255, at which point it rolls back to zero again.
TIMER	10	The field is an AF formatted string indicating the number of seconds that have passed since the end of the initialization sequence. This field is left padded with zeros and is precise to two digits after the decimal.
CHECK SUM	1	This is a BU formatted data integrity sensor which implements a check sum on the telemetry frame.
TERMINATOR	2	This field indicates the end of the frame. The frame is terminated by a carriage return/line feed pair (0D <sub>hex</sub> and 0A <sub>hex</sub> ).

 <b>Operation Manual</b>	SYSTEM	<b>HyperSAS</b>
	SECTION	<b>E. CONFIGURATION</b>

## E. CONFIGURATION

Your HyperSAS network hub has been pre-configured by Satlantic with standard configuration parameters. These parameters control many aspects of the instruments operation to account for the wide variety of applications in which the hub instruments are used. In addition to the operating modes described in section **D-OPERATION**, a configuration mode is also available to modify configuration parameters and test various systems of the instrument. This configuration mode is implemented by the instruments **Command Console**.

In most cases, the command console would be accessed using a terminal emulation program. Terminal emulators are used in many applications involving serial communications, internet mail and news services, telnet and ftp services, etc. For communication with your HyperSAS, you will need to make a direct connection to the serial port hosting the instrument. Connect the instrument using the RS-232 telemetry interface. You cannot use the RS-422 interface, as it is transmit-only. For communications software, use your favorite terminal emulator (Windows<sup>®</sup> comes with one called HyperTerminal<sup>®7</sup>). Ensure that the serial connection to the instrument is at the *telemetry baud rate*. Use any ANSI or ANSI-compliant (i.e. VT-xxx) emulation. While operating in this mode, your HyperSAS uses simple character I/O with no control character interpretation. Therefore, most terminal emulators will do.

The command console can be accessed at any point during the instruments operation. You can even access the command console of a remote or networked instrument through the Network Master. Methods for accessing the console are described in section **D-OPERATION**.

**IMPORTANT!** This section goes into great detail about the SatNet aspect of the HyperSAS, and is intended for advanced users only. Most users will not require any knowledge of this system, as the instrument is essentially a “plug and play” device when used with SatView. Changing any parameters will affect system operation – please discuss any changes with a Satlantic representative before modifying these settings.

### **Command Console**

The HyperSAS network hub command console was designed to resemble an MS-DOS<sup>®</sup> or UNIX<sup>®</sup> command prompt<sup>8</sup>. Although the actual functionality of the console is quite removed from these systems (it is actually far simpler), the basic design lends a certain degree of familiarity.

<sup>7</sup> See the **Error! Reference source not found.** section for more information on using HyperTerminal. HyperTerminal is a registered trademark of Microsoft Corporation.

<sup>8</sup> MS-DOS and UNIX are registered trademarks of Microsoft Corporation and The Open Group respectively.

 <b>Operation Manual</b>	SYSTEM <h1 style="text-align: center;">HyperSAS</h1>
	SECTION <h2 style="text-align: center;">E. CONFIGURATION</h2>

When the console is first invoked, you will see a prompt on your terminal emulator screen similar to the one shown below:

```
MicroPro Profiler Command Console
Type 'help' for a list of available commands.

[Master:001]$
```

The first two lines are the command prompt header. They are not repeated unless you reset the console. The first line indicates the type of instrument for which the console is being used. The next line helps new users to get acquainted with the system.

The actual command prompt ends with the “\$” character. The characters between the [ ] brackets provide information on the operating mode of the instrument. In the example above, “Master” indicates that the instrument is running in Network Master mode. The numbers following the “:” character is the three-digit network address for the HyperSAS hub. If the instrument is running in network mode, which means the command console was accessed through the Network Master, the command prompt will look something like this:

```
[Remote:001]$
```

The “Remote” keyword indicates that the command prompt is for a remote or networked instrument. The numbers following the “:” character is the three-digit network address of the remote instrument. This gives the user the ability to quickly differentiate one remote instrument from another. In Autonomous mode, the prompt would simply show “[Autonomous]\$”.

Using the command prompt is quite simple. Type in a command at the prompt followed by the <Enter> key. This will execute the command, displaying the results to the screen, if any. You can easily edit commands if you make a mistake. Use the <Backspace> key to delete characters in your command before you execute them. You can even recall the last executed command by pressing the <Esc> key on a clear command prompt. This is handy if you are repeatedly executing the same or similar commands.

The command console interprets all commands as case sensitive. This means that the command “exit” is different from “EXIT”. Most commands require small case letters.

If this is your first time using the command console, a good starting point is the “help” command. As you probably noticed, the command prompt header suggests this command for novice users. Executing this command will display the following text:

 <b>Operation Manual</b>	SYSTEM <h1 style="text-align: center;">HyperSAS</h1>
	SECTION <h2 style="text-align: center;">E. CONFIGURATION</h2>

The following console commands are available for this instrument:

```

reset      Resets the command console.
id         Displays the instrument identification banner.
power     Turns operational power on and off.
set       Sets the instrument's configuration parameters.
show     Shows the instrument's configuration parameters.
save     Saves the instrument's configuration parameters.
ping     Pings the network for remote instrument(s).
remote   Engages the command console of a remote instrument.
query    Queries the external sensor A/D converter.
sample   Takes a test sample of all A/D channels.
vout     Turns external device power on and off.
exit     Exits the command console.
exit!    Exits the command console and resets
         the instrument.

```

For more information on individual commands, type '-?' after the command.

All commands available to the instrument are listed on the left, with descriptions on the right. For the most part, these descriptions adequately define the purpose of each command. However, some commands are more complex and require a little more than a simple one-word entry. As indicated above, you can type a “-?” after a command to display additional help information. Make sure there is a space between the command and the “-?” parameter. If there is additional help available for the command, the text will be displayed. Otherwise, a message indicating, “No more help is available.” will be displayed.

Some commands require additional command line parameters. Executing one of these commands with missing or incorrect parameters will display a “Usage:” message. This is helpful in determining what parameters are acceptable for a particular command and how they should be formatted. For example, if you executed the “power” command without any parameters, the following message would be displayed:

```
Usage: power [operational power (on|off|?)]
```

This command requires one parameter, as indicated by the contents of the [ ] brackets. If the command required more than one parameter, additional sets of [ ] brackets with their parameter descriptions would be displayed. Parameters must always be separated by a space. Within the [ ] brackets is a description of the parameter followed by the list of acceptable parameter values, contained in the ( ) brackets. The values listed here are always separated by the “|” character. In this case, there are three accepted forms of this command; “power on”, “power off”, and “power ?”.

 <b>Operation Manual</b>	SYSTEM <p style="text-align: center;"><b>HyperSAS</b></p>
	SECTION <p style="text-align: center;"><b>E. CONFIGURATION</b></p>

Generally, the usage of the command console is self-explanatory. It should only take you a few moments to get a working knowledge of the system. Although the on-line help is fairly extensive, some commands need more detailed explanations that would be too cumbersome to include in the instrument itself. The following sections describe each command in more detail.

### Reset Command

The “reset” command resets the console, redisplaying the command prompt header described above. Any configuration parameters modified during the console session that were not saved will revert back to their previous values. This command requires no additional command line parameters.



 <b>Operation Manual</b>	SYSTEM <p style="text-align: center;"><b>HyperSAS</b></p>
	SECTION <p style="text-align: center;"><b>E. CONFIGURATION</b></p>

### ID Command

The “id” command displays the identification banner for the instrument, as shown is the following example:

```
Satlantic MicroPro Profiler
Copyright (C) 2002, Satlantic Inc. All rights reserved.
Firmware version: 1.2A(P), 2.1A(S) - SatNet Type A
Instrument: SATMPR
S/N: 0048
```

The identification banner is also part of the start-up banner, which is displayed during the initialization sequence described in section **D-OPERATION**. This command requires no additional command line parameters.

### Power Command

The “power” command may be used to turn operational power on and off during a command console session. Operational power supplies electronic components in the instrument responsible for sensor data acquisition. Powering down these components will reduce the instruments total power consumption, but you will no longer be able to obtain ancillary data. The instrument is otherwise fully operational, so communication is still possible. When operational components are powered down, sensor data acquisition is disabled.

This command requires one command line parameter. To turn on operational power, use the “power on” command. To turn off operational power, use the “power off” command. To query the operational power status, use the “power ?” command. This will display a message similar to the one below:

```
Operational Power: on
```

**IMPORTANT! Operational power will remain in the state set by this command once the command console exits and normal operation resumes.**

### Set Command

The “set” command modifies configuration parameters for the instrument. These parameters affect various aspects of the instruments operation and can be modified by the user to customize the instrument.

 <b>Operation Manual</b>	SYSTEM	<b>HyperSAS</b>
	SECTION	<b>E. CONFIGURATION</b>

For a HyperSAS hub, , if you enter a “set -?” command, the following will be displayed:

```
Usage: set [parameter] [value]

set telbaud [telemetry baud rate (bps)]
set maxrate [maximum frame rate (Hz)]
set initsm [initialize silent mode (on|off)]
set initpd [initialize power down (on|off)]
set initat [initialize auto telemetry (on|off)]
set netmode [network mode (on|off)]
set netadd [network address (1-255)]
set netbaud [network baud rate (bps)]
set master [network master (on|off)]
set mct [master controlled telemetry (on|off)]
set bias [master network bias (on|off)]

set vout [initialize external power (on|off)]
```

This command requires two command line parameters. The first parameter specifies the configuration parameter to modify. The second specifies the new value to assign to the parameter. A list of all available configuration parameters is shown above.

**IMPORTANT! Be careful using this feature. Changes made to the HyperSAS configuration parameters affect the way the instrument operates. Before you modify any of configuration parameters, make sure you understand the consequences of the change.**

For more information on these parameters and their affect on your instruments operation, see section **HyperSAS Configuration Parameters** below.

### Show Command

The “show” command displays configuration parameters for the instrument. These parameters are modified by the “set” command explained above. If you enter “show -?” at the command prompt, the following message will be displayed:

```
Usage: show [parameter|all]

See help for the 'set' command for a list of
available parameters.
```

This command requires only one command line parameter, which is the same as the first parameter of the “set” command. Using the “show” command in this way displays the current value of the configuration parameter, even if it has not yet been saved. You may also use “all” as

 <b>Operation Manual</b>	SYSTEM <p style="text-align: center;"><b>HyperSAS</b></p>
	SECTION <p style="text-align: center;"><b>E. CONFIGURATION</b></p>

the command line parameter to show a complete list of all configuration parameters and their current values. For example, using the “show all” command on your HyperSAS would display something like this:

```

Telemetry Baud Rate: 57600 bps
Maximum Frame Rate: 10 Hz
Initialize Silent Mode: off
Initialize Power Down: off
Initialize Automatic Telemetry: on
Network Mode: on
Network Address: 001
Network Baud Rate: 38400 bps
Network Master Mode: on
Master Controlled Telemetry: off
Master Network bias: on

Initialize external power: on

```

For more information on these parameters and their affect on your instruments operation, see section **HyperSAS Configuration Parameters** below.

### Save Command

Modifying configuration parameters with the “set” command does not necessarily mean that those parameters will be retained for use in the next session with the instrument. When the “save” command is issued, all configuration parameters are placed in persistent storage inside the instrument. If these parameters are not saved once they are modified, all changes will be lost when the command console exits or power is removed from the instrument.

The “save” command requires no additional command line parameters. Once the command is issued, it cannot be undone.

**IMPORTANT! Once the instruments configuration parameters have been saved, the instrument must be reset before normal operation can resume.**

### Ping Command

The “ping” command is only available to network master instruments. It can be used to test the presence of slave devices on the network, and to determine their network addresses.

If you enter “ping -?” at the command prompt, the following message will be displayed:

 <b>Operation Manual</b>	SYSTEM <p style="text-align: center;"><b>HyperSAS</b></p>
	SECTION <p style="text-align: center;"><b>E. CONFIGURATION</b></p>

Usage: ping [network address (1-255|all)]

Use this command to ping a network address. If an instrument is present, it's identification will be displayed.

This command requires only one command line parameter, either a known network slave address (1-255) or "all". For example, if you wish to ping the instrument at address 100, you would enter "ping 101" and receive a response similar to the following:

```
101> Instrument: SATHSL - S/N: 0045
```

if an instrument is present at that address. If not, you will receive a "No response" message.

Using "all" as the command line parameter will send a global ping command to all slaves on the network. For example, issuing a "ping all" command from the HyperSAS network hub command console would give a response similar to the following:

```
100> Instrument: SATHSE - S/N: 0044
101> Instrument: SATHSL - S/N: 0045
```

The exact response will of course depend on your instrument configuration.

Note: occasionally, slave sensors may not respond to the "ping all" command properly; you may have to issue the command several times to determine all the slaves on the network.

### Remote Command

The "remote" command is only available to network master instruments. It can be used connect directly to a remote network slave's command console through the network. In order to connect to the remote slave, its network address must be known – this can be determined using the "ping all" command explained above. Note that the term "remote" does not imply a distantly located instrument, only that it is a instrument other than the network master.

If you enter "remote -?" at the command prompt, the following message will be displayed:

Usage: remote [network address (1-255)]

Use this command to engage the command console of a networked instrument. The command prompt will indicate the address of the remote (or networked) instrument.

 <b>Operation Manual</b>	SYSTEM <p style="text-align: center;"><b>HyperSAS</b></p>
	SECTION <p style="text-align: center;"><b>E. CONFIGURATION</b></p>

This command requires only one command line parameter – a known remote instrument address. For example, to connect to an instrument at remote address 100, enter “remote 100”. Assuming that address is in use and it is an OCR-3000, the following message would be displayed:

```
OCR-3000 Command Console
Type 'help' for a list of available commands.
```

```
[Remote:100]$
```

You are now indirectly connected to the remote instrument’s command console at the specified network instrument. Any command normally accessible from the slave’s telemetry interface is now accessible through the network master. This capability is very useful for troubleshooting and for changing operational parameters for the slave, as a direct connection to the slave is not required. Be careful what settings you change on the remote instrument!

To return to the network master’s command console, simply enter the ‘exit’ command.

### Query Command

The “query” command is a HyperSAS debugging command that is only useful to Satlantic staff, but is detailed here for completeness. Issuing this command returns various settings from the ancillary sensor’s A/D. If you enter this command, you will get a response similar to the following:

```
CR:      04E1
CCR1:    F090B0D0
CCR2:    70103050

OFS:
      40 3E 00 40 3E 00
      40 3E 00 40 3E 00
      40 3E 00 40 3E 00
      40 3E 00 40 3E 00

+SF:
      20 00 00 20 00 00
      20 00 00 20 00 00
      20 00 00 20 00 00
      20 00 00 20 00 00

-SF:
      DF FF FF DF FF FF
      DF FF FF DF FF FF
      DF FF FF DF FF FF
      DF FF FF DF FF FF
```

 <b>Operation Manual</b>	SYSTEM <p style="text-align: center;"><b>HyperSAS</b></p>
	SECTION <p style="text-align: center;"><b>E. CONFIGURATION</b></p>

### Sample Command

The “sample” command can be used to test the operation of all sensors on board the instrument. This may be helpful in diagnosing problems with any of the instruments sensors if some kind of abnormality occurs. Before using this command, make sure operational power has been applied.

When a sensor is sampled by this command, its value is displayed in hexadecimal format. This value is simply the number of counts measured by the sensor’s Analog-to-Digital converter. These values do not represent sensor output in physical units.

This command requires no additional command line parameter – all available measurements are made. Using the “sample” command will display something similar to the following:

```
External sensor A/D converter test sample:
```

```
1: 7FF5
2: 7FFE
3: 7FF6
4: 8001
5: 8004
6: 8000
7: 8001
8: 0D56
```

```
VIN test sample:      0192
VA test sample:      00A7
V15 test sample:     01F8
Int. temp. test sample: 0099
```

### Vout Command

The “vout” command is a HyperSAS command that allows the user to turn power to the slave instruments on and off. This command is normally useful only as a test feature.

Entering the “vout” command without any parameters will display its usage:

```
Usage: vout [external power (on|off|?)]
```

As can be seen, this command accepts three command line parameters. Using the “on” parameter forces the external power to turn on, while using the “off” parameter turns it off. The “?” parameter returns the current state of the external power.

 <b>Operation Manual</b>	SYSTEM	HyperSAS
	SECTION	<b>E. CONFIGURATION</b>

## Exit and Exit! Commands

The “exit” and “exit!” commands end the current command console session. Once the console exits, normal operation will resume in most cases. Otherwise, the instrument will reset itself before normal operation can begin. The only difference between the two versions of this command is that the “exit!” command forces a reset of the instrument, even if it isn’t necessary.

There are two conditions that will cause the instrument to reset itself. One or both conditions must exist for this to occur. These conditions are:

1. The command console was invoked during the initialization sequence.
2. Configuration parameters have been modified and saved.

If you attempt to exit the console with modified configuration parameters that have not been saved, the following dialog will be presented:

```
The configuration parameters have been modified.
Save changes [y/n]?
```

Choose “y” for yes or “n” for no to answer this question. If you choose yes, the configuration parameters will be saved and the instrument will reset itself. Otherwise, any modifications to the configuration parameters will be lost. See the **Save Command** section above for more information on saving configuration parameters.

## **HyperSAS Configuration Parameters**

This section describes, in detail, the function of each configuration parameter used by the HyperSAS network hub. The title of each section identifies the name of the parameter, as displayed by the “show” command. Also clearly identified in each section is the command line parameter keyword used in both the “set” and “show” commands.

See the descriptions of the “set” and “show” commands described in the **Command Console** section above for more information.

### Telemetry Baud Rate

**Command Line Parameter:** telbaud

The telemetry baud rate defines the speed at which data is transferred on the telemetry interface. This should not be confused with the frame rate. Baud rates are specified in units of *bits per second* (bps). Any data acquisition or terminal emulation software must be configured to communicate with the instrument at this baud rate. Only certain standard parameter values are accepted, as shown in the table below:

 <b>Operation Manual</b>	SYSTEM	HyperSAS
	SECTION	<b>E. CONFIGURATION</b>

Baud Rate (bps)
9600
19200
38400
57600
115200

When modifying this parameter with the “set” command, you must enter at least the first two digits of one of these baud rates as the value parameter.

Ideally, you would want the telemetry interface to run at the fastest baud rate available. However, certain restrictions, like cable quality or excessively long transmission mediums, may require a reduction in the telemetry baud rate. The data acquisition computer and/or software may also impose restrictions.

#### Maximum Frame Rate

**Command Line Parameter:** `maxrate`

This parameter allows you to define the maximum frame rate that the instrument will use during normal operation with free-running telemetry output. The frame rate defines how often a frame of telemetry is composed and transmitted. If the instrument is running autonomously (autonomous operation), frames are transmitted through the telemetry interface. If the instrument is operating in network mode (network operation), these frames are transmitted through the network interface. However, the Network Master can be configured to override the frame rates of all other instruments using the *master controlled telemetry (mct)* option.

Frame rates are specified in units of *frames per second* or *Hertz* (Hz). There are several factors involved in determining how quickly the instrument can transmit frames. On-board electronics, such as the Analog-to-Digital converter used to sample each sensor, may limit how fast a telemetry frame can be composed. Configuration parameters like the telemetry and/or network baud rates are important in determining how quickly one frame can be transmitted before the next. While in network operation, saturation of the Network Master’s telemetry interface, caused by too many networked instruments broadcasting their telemetry at the same time, may slow down the frame rate of some or all instruments in the system. Therefore, the actual frame rate realized during normal



 <b>Operation Manual</b>	SYSTEM <h2 style="text-align: center;">HyperSAS</h2>
	SECTION <h3 style="text-align: center;">E. CONFIGURATION</h3>

operation cannot be any faster than the limitations imposed by these conditions. And some of these factors may vary during normal operation, making the determination of a constant frame rate impossible. Providing a maximum frame rate slower than what the instrument is capable of providing will help pace the output of each frame evenly. Generally, a HyperSAS hub cannot exceed a frame rate faster than 10 Hz, even under the best of conditions.

Only certain standard frame rates are accepted by this parameter, as shown in the table below:

Frame Rate (Hz)
0.125
0.25
0.5
1
2
4
8
10
12
0 (AUTO)

When modifying this parameter with the “set” command, you must enter one of these numbers as the value parameter. Any numerical values that are in between the values in the table will be rounded up to the nearest standard frame rate. To specify an automatic (AUTO) frame rate, input “0” as the value parameter. This will cause the instrument to output frames as fast as possible.

Specifying a frame rate faster than is practically possible will not force the actual frame rate to that level. The instrument will only transmit as fast as possible for the given operating parameters. This is essentially the same as specifying an AUTO frame rate. In addition, frames are always transmitted as a whole as much as possible. Once a frame starts transmitting, it is transmitted continuously until the frame is completely output. Specifying a frame rate of, for example, 0.5 Hz does not mean that half a frame is transmitted every second. It means that every two seconds, a frame will begin transmitting.

 <b>Operation Manual</b>	SYSTEM	HyperSAS
	SECTION	<b>E. CONFIGURATION</b>

### Initialize Silent Mode

**Command Line Parameter:** `initism`

Normally, just after the instrument is powered up or reset, a start-up banner will be output on the telemetry interface during the initialization sequence. The messages in this banner, among other things, identify the instrument and provide a copyright notification. If silent mode is enabled, this banner will not be displayed. This ensures that no data will be transmitted on the telemetry interface until, if running autonomously, normal operation begins and telemetry output is available. Enabling silent mode does not mean that the telemetry interface is disabled during initialization. The command console can still be engaged. See section **D-OPERATION** for more information on the start-up banner and the initialization sequence.

When modifying this parameter with the “set” command, you must enter either “on” or “off” as the value parameter to enable or disable silent mode.

### Initialize Power Down

**Command Line Parameter:** `initpd`

Near the end of the initialization sequence, operational power is normally applied. However, the instrument can be configured to boot into a power savings mode. With the initialize power down parameter enabled, operational power will not be applied during initialization. This means that telemetry output will be disabled when normal operation begins. See section **D-OPERATION** for more information on the initialization sequence.

When modifying this parameter with the “set” command, you must enter either “on” or “off” as the value parameter to enable or disable the power savings mode.

### Initialize Automatic Telemetry

**Command Line Parameter:** `initat`

For instruments running in autonomous operation only, the telemetry output mode can be configured to start as free-running or polled once normal operation begins. This means that once normal operation has begun and this parameter is disabled (polled operation), telemetry output will not occur unless the instrument is polled with the <Enter> or <Space> key commands. Otherwise, telemetry output will be free-running in accordance with the maximum frame rate configuration parameter. Of course, if operational power is not applied, telemetry output is disabled

 <b>Operation Manual</b>	SYSTEM	HyperSAS
	SECTION	<b>E. CONFIGURATION</b>

altogether regardless of this parameter. See **Autonomous Operation** in section **D-OPERATION** for more information on telemetry output modes.

When modifying this parameter with the “set” command, you must enter either “on” or “off” as the value parameter to enable or disable automatic telemetry.

### Network Mode

**Command Line Parameter:** `netmode`

This parameter enables or disables network operation for the instrument. Although disabling this parameter will force the instrument to run autonomously, enabling it does not necessarily mean network operation will be invoked. The instruments operating mode is determined during the initialization sequence. See **Network Operation** in section **D-OPERATION** for more information.

When modifying this parameter with the “set” command, you must enter either “on” or “off” as the value parameter to enable or disable network operation.

### Network Address

**Command Line Parameter:** `netadd`

The network address uniquely identifies an instrument on a network. All network transmissions use this parameter to identify the sender and receiver of the message. It is not important what value is assigned to the network address, as long as it is unique from other instruments in the network.

**IMPORTANT! Make sure that each device on the network, including the Network Master, has a unique network address. If two or more devices have the same address, contentions may result and data could be lost.**

When modifying this parameter with the “set” command, you must enter an integer from 1 to 255 inclusive as the value parameter.

### Network Baud Rate

**Command Line Parameter:** `netbaud`

The network baud rate defines the speed at which data is transferred on the network interface. Baud rates are specified in units of *bits per second* (bps). Only certain standard parameter values are accepted, as shown in the table below:

 <b>Operation Manual</b>	SYSTEM <p style="text-align: center;"><b>HyperSAS</b></p>
	SECTION <p style="text-align: center;"><b>E. CONFIGURATION</b></p>

Baud Rate (bps)
9600
14400
19200
28800
38400
57600
76800

When modifying this parameter with the “set” command, you must enter at least the first two digits of one of these baud rates as the value parameter.

**IMPORTANT! Make sure that each device on the network, including the Network Master, is operating with the same network baud rate. Any devices in the network running at a baud rate different from the Network Master will be ignored.**

Ideally, you would want to run the network at the fastest baud rate available. However, certain restrictions, like cable quality or excessively long transmission mediums, may require a reduction in the network baud rate.

#### Network Master Mode

**Command line parameter:** `master`

The network master mode setting determines whether or not the instrument will act as a network master.

When modifying this parameter with the “set” command, you must enter either “on” or “off” as the parameter value to enable or disable network master mode.

#### Master Controlled Telemetry

**Command line parameter:** `mct`

The master controlled telemetry setting determines whether or not the master controls the frame rate of the slave instruments. In a typical SatNet environment, slaves are allowed to “free-run”, outputting telemetry

 <b>Operation Manual</b>	SYSTEM	HyperSAS
	SECTION	<b>E. CONFIGURATION</b>

when it is available. However, the master device can force its frame rate onto the slave devices by enabling this parameter.

**IMPORTANT! Slave devices may not be able to update their frames as fast as the network master. In this instance the mct parameter will have no effect.**

When modifying this parameter with the “set” command, you must enter either “on” or “off” as the parameter value to enable or disable master controlled telemetry.

### Master Network Bias

**Command line parameter:** `bias`

The master network bias setting determines whether or not the instrument enables its network biasing circuitry.

**IMPORTANT! The network bias circuitry must be enabled for normal network operation.**

The basic rule of thumb is that if a device is configured as a Network Master, its bias circuit must be enabled. If the device is configured as a slave, the bias circuit must be disabled.

When modifying this parameter with the “set” command, you must enter either “on” or “off” as the parameter value to enable or disable the bias circuitry.

### Initialize External Power

**Command line parameter:** `vout`

The initialize external power setting determines whether or not the instrument turns on power to the slaves at start-up.

**IMPORTANT! The slaves will not operate if this parameter is disabled.**

When modifying this parameter with the “set” command, you must enter either “on” or “off” as the parameter value to enable or disable output power at start-up.

 <b>Operation Manual</b>	SYSTEM	HyperSAS
	SECTION	<b>F. RECOVERY</b>

## F. RECOVERY

The recovery procedure for the HyperSAS will depend on the application.. Normally, recovery is simply the reverse of the deployment.

A generic recovery procedure is as follows:

1. Terminate data logging.
2. Remove AC power from the temperature sensor junction box, if present.
3. Remove power from the  $E_S$  sensor
4. Remove power to the MDU-100 (if present), or disconnect the power source for the  $L_T$  and  $L_i$  heads if no network hub is present.
5. Remove the associated power/telemetry cables from the devices, and replace all dummy connectors and locking sleeves.
6. Carefully remove the optical sensors from their mounting surfaces. . You will need to cut the cable ties in order to do so. **Be careful not to damage the sensor when cutting the cable ties!**
7. Carefully clean the devices with fresh water. When dry, replace all protective vinyl end caps.
8. Inspect both devices for any damage that may have occurred during the deployment period.
9. Carefully remove the SAS mounting plate from the deployment structure. Disassemble the SAS frame as required for storage.
10. Store the instruments, preferably in their original shipping cases to protect them from damage.

 <b>Operation Manual</b>	SYSTEM <p style="text-align: center;"><b>HyperSAS</b></p>
	SECTION <p style="text-align: center;"><b>G. MAINTENANCE</b></p>

## G. MAINTENANCE

The following sections provide information necessary to keep the HyperSAS system in peak operating condition.

### ***Preventative Maintenance***

The HyperSAS requires virtually no maintenance. The life of the instrument will be prolonged by protecting it from impacts, rinsing it with fresh water (to remove seawater overspray) after each use and properly storing the instrument with the dummy connectors and optical sensor end caps on when not in use.

If the instrument is not working properly the following troubleshooting techniques can be followed. If these are not successful, contact Satlantic for more information.

### ***Troubleshooting with HyperTerminal***

Occasionally, new SatView users may experience difficulty configuring the program properly in order to view and log HyperSAS telemetry. Windows'9x includes the HyperTerminal program for serial data communication. This program provides a useful tool for quickly checking to see if telemetry is being received from the HyperSAS.

#### Checking for HyperTerminal Installation

HyperTerminal may not be installed on your computer. It is, however, a standard part of Windows'9x. Check to see if HyperTerminal is installed by entering **Start -> Programs -> Accessories**. If a **HyperTerminal** folder is visible in the **Accessories** folder, HyperTerminal is already installed.

 <b>Operation Manual</b>	SYSTEM	HyperSAS
	SECTION	<b>G. MAINTENANCE</b>

## Installing HyperTerminal

Adding HyperTerminal is very straightforward; open up the **Control Panel** and click on the **Add/Remove Programs** item. Go through the dialogs as shown to install the program.

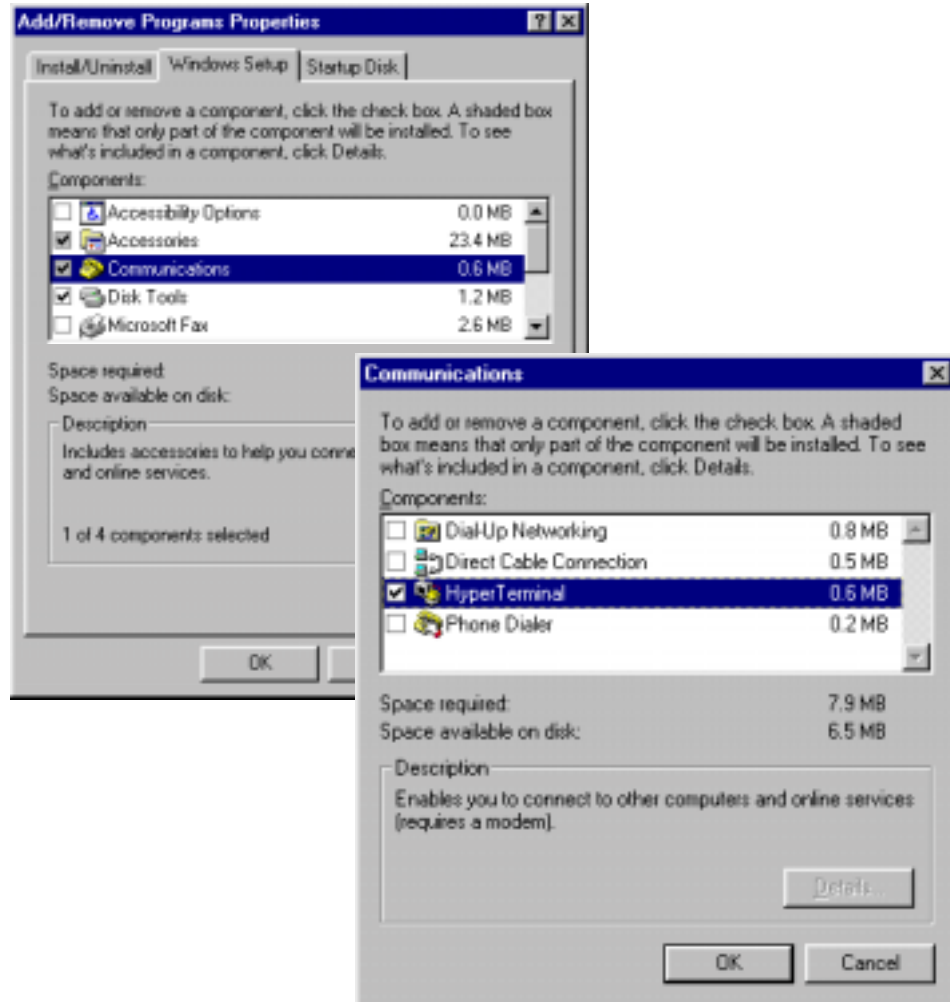



 <b>Operation Manual</b>	SYSTEM <p style="text-align: center;">HyperSAS</p>
	SECTION <p style="text-align: center;"><b>G. MAINTENANCE</b></p>

### Configuring HyperTerminal

To start the HyperTerminal program, go to the Start menu and select Run, then type **hypertrm** in the Run dialog box. An alternative method is to enter the HyperTerminal folder through **Start ->Programs -> Accessories -> HyperTerminal**, then double-clicking on the **hypertrm.exe** icon. At startup, HyperTerminal initiates a configuration with a new connection dialog box. It is helpful to create an informative name for the connection we are about to create, as shown in the following figure. The name as shown indicates that we will have a connection on COM1, at 57600 baud.

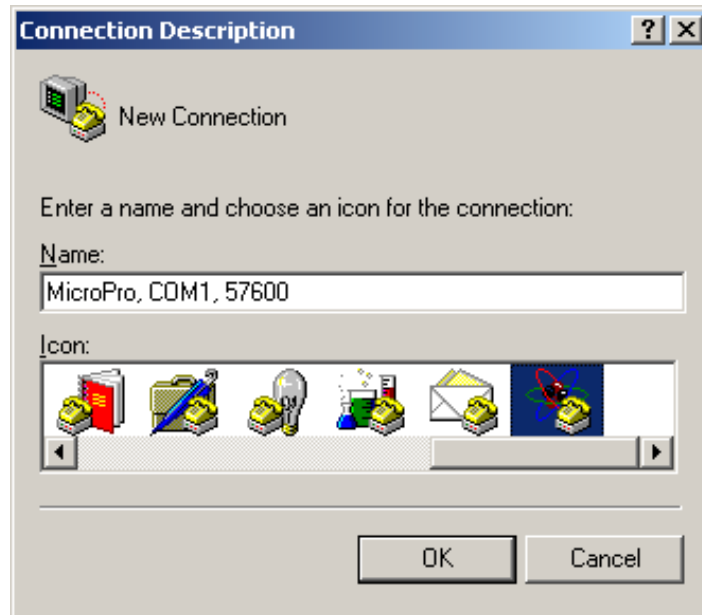

**Note:**

You may notice that the following diagrams indicate a “MicroPro” instrument is being used, and not a HyperSAS. The procedures for both instruments are identical, however.

 <b>Operation Manual</b>	SYSTEM	<b>HyperSAS</b>
	SECTION	<b>G. MAINTENANCE</b>

The phone number dialog box will then open. HyperTerminal is biased towards telephone and modem based connections, but for the HyperSAS a direct connection is required. We need to avoid any automatic search by the program for a modem and select a direct COM port connection. Below we see that COM 1 has been selected.



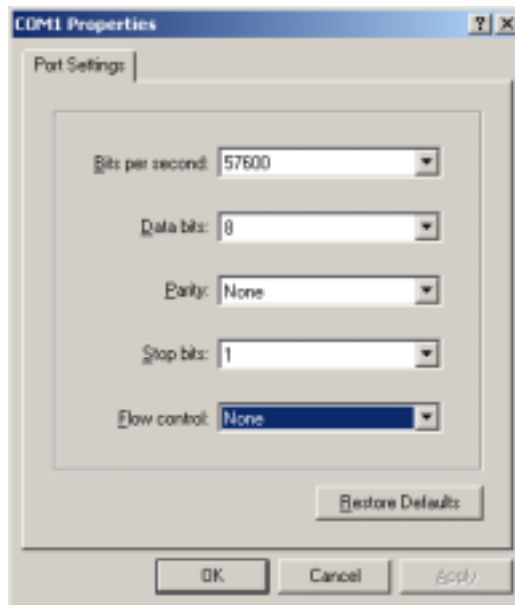

Finally HyperTerminal will ask for the asynchronous serial port communication parameters that will be used in the connection. This is shown in the COM1 Properties dialog box (below). The properties required for the HyperSAS are as follows: 57600 bits per second, 8 data bits, no parity, 1 stop bit, and no flow control. You do not need to use the *Advanced* button in this dialog box (if present).

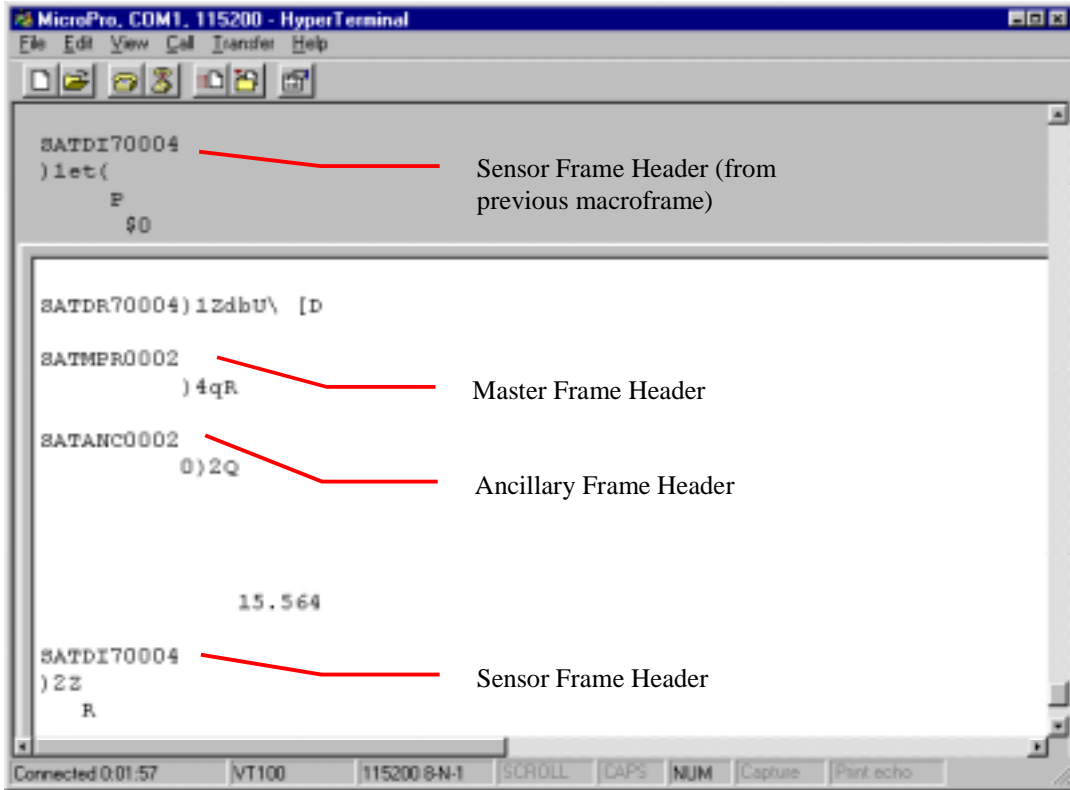

 <b>Operation Manual</b>	SYSTEM <h1 style="text-align: center;">HyperSAS</h1>
	SECTION <h2 style="text-align: center;">G. MAINTENANCE</h2>

After completing this dialog and pressing the OK button, HyperTerminal's main window will be displayed, as shown below. If the HyperSAS has been assembled correctly and is turned on, the output telemetry stream should now be visible, similar to that shown.



 <b>Operation Manual</b>	SYSTEM	<b>HyperSAS</b>
	SECTION	<b>G. MAINTENANCE</b>

At this point the connection will be established and it should be possible to see telemetry from the HyperSAS. However, the configuration process is not yet complete. The program is currently configured to auto-detect the type of terminal that it should be emulating. This is inappropriate for use with the HyperSAS and may cause problems. To correct this, from the **File** menu you should click the **Properties** selection and change the terminal type. Select the **Settings** tab of the dialog box and change the **Emulation** from **Auto Detect** to **TTY** as shown. Setting the emulation type to **VT100** also works well.

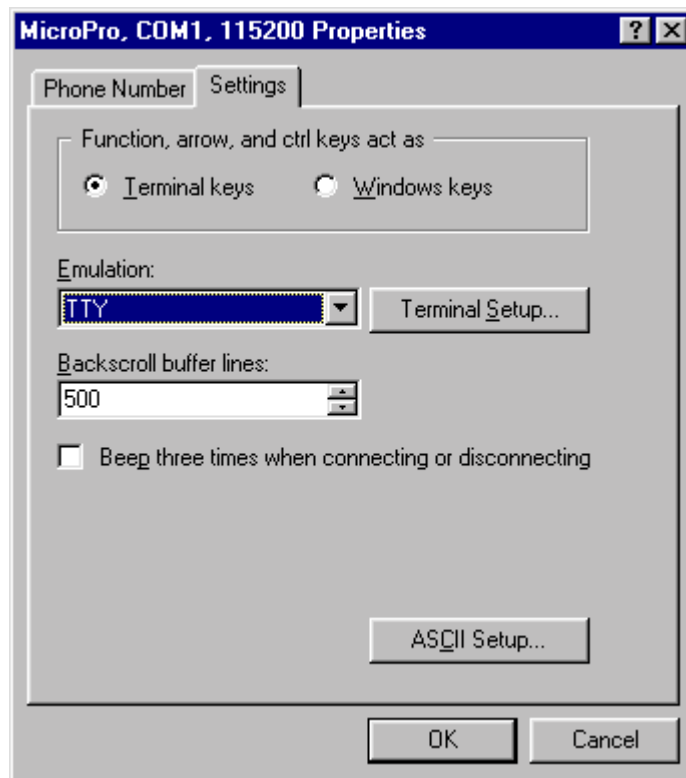

 <b>Operation Manual</b>	SYSTEM <h1 style="text-align: center;">HyperSAS</h1>
	SECTION <h2 style="text-align: center;">G. MAINTENANCE</h2>

If the HyperSAS has been set up properly, when you press the OK button you will see telemetry as shown in the previous figure. You may have to press the Disconnect button, then the Reconnect button for the telemetry to display properly. Notice that the master, ancillary, and sensor headers are all visible. Sometimes you will not be able to see some or all of the headers; this is often due to carriage return characters being present in the data frame, causing HyperTerminal to overwrite the headers. Occasionally simply changing the emulation type to something else (such as VT100 instead of TTY) alleviates the problem somewhat. If not, you can also append line feeds to incoming line ends. From the same window where the emulation type was set, press the **ASCII Setup** button. Check the box that says "Append line feeds to incoming line ends", as shown below. This should allow you to easily see most headers.

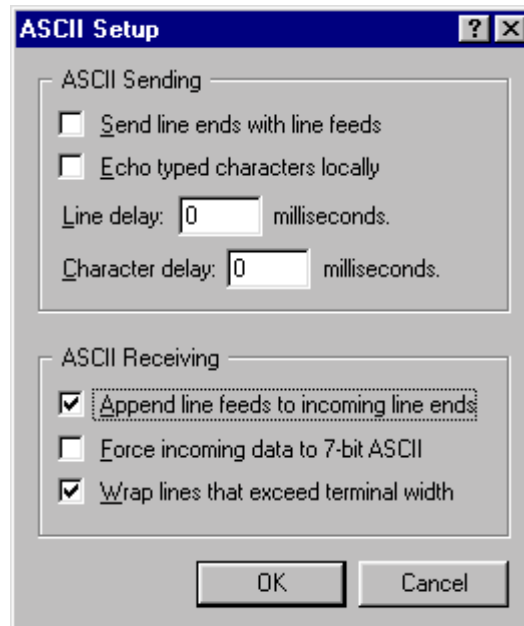

 <b>Operation Manual</b>	SYSTEM <p style="text-align: center;"><b>HyperSAS</b></p>
	SECTION <p style="text-align: center;"><b>G. MAINTENANCE</b></p>

### ***Troubleshooting for Hardware Problems***

If, after running Hyperterminal, telemetry is not visible in the HyperTerminal window, there could be a hardware problem. The connections can be checked and voltage checks can be conducted on the cables and components, as outlined below. To check voltages, a multimeter with DC voltage measurement, resistance measurement, and continuity check capability is required.

**WARNING!** *While checking voltages, extreme care should be used so as not to short the probe leads. A shorted power supply or battery can output many amperes of current, potentially harming the user, starting fires, or damaging equipment.*

#### Check Connections

#### **Procedure**

1. Ensure power/telemetry cable is properly connected to MDU-100 and to HyperSAS main housing.
2. Ensure all sensor interconnect cables are in place and properly connected.
3. Ensure power supply is properly connected to the MDU-100.
4. Ensure RS-232 cable is connected to the correct PC communications port (COM1 in the example given) and to the MDU-100.
5. Ensure no other programs are running that could be using the communications port.

 <b>Operation Manual</b>	SYSTEM	HyperSAS
	SECTION	<b>G. MAINTENANCE</b>

### Check The Supply Voltage To The MDU-100

The MDU-100 deck unit is essentially a DC-DC converter. An input voltage in the range of 10 - 20 Vdc is converted to a regulated 48 Vdc. Voltages above the maximum input voltage of 20 Vdc may damage the MDU-100; voltages below the minimum operating voltage of 10 Vdc may cause the device to drop out of regulation. Thus the user should ensure the voltage input to the MDU-100 is within the allowed range of 10 - 20 Vdc.

### Procedure

1. Set the multimeter to measure a DC voltage.
2. If using a battery as the power source, measure the voltage directly at the battery terminals with the multimeter. A new or fully charged 12 V battery usually measures in the 13 - 15 V range. If the voltage is low (under 11 V) then recharge or replace the battery. If using a DC power supply, set the output voltage in the range from 10 - 20 V, and check the voltage with the multimeter.
3. Connect the power supply cable to the power source.
4. **Being extremely careful not to short the probe leads**, measure the voltage between pins 1 and 2 on the IL-2F connector (on the supply cable). It should read approximately the same as the measurement taken in step 2. If the voltages are not the same, recheck the power supply cable connections. If they are still not the same, there is likely a break in the cable that requires repair (a wire break can be confirmed with a *continuity check*).
5. If the voltage is ok, connect the power supply cable to the MDU-100.
6. Again measure the voltage at the power supply terminals. The voltage should remain approximately the same as before, although there may be a small voltage drop when using a battery (battery voltage drops under load). If there is a significant voltage drop, disconnect the power immediately and check for shorts in the cable.

 <b>Operation Manual</b>	SYSTEM	<b>HyperSAS</b>
	SECTION	<b>G. MAINTENANCE</b>

### Check The Output Voltage From The MDU-100

To check the output voltage from the MDU-100, a multimeter, as described above, is required. As previously mentioned, the MDU-100 outputs a regulated 48 Vdc (nominal) voltage. Use the following procedure to check this voltage.

#### Procedure

1. Set up the MDU-100 input power as outlined in the **MDU-100 Input Voltage Check** section.
2. Ensure the multimeter is configured to measure DC voltage.
3. **Being extremely careful not to short the probe leads**, insert the negative (black) probe lead in Pin 2 and the positive (red) probe lead in Pin 1 of the BH-4F connector on the MDU-100. The measurement should read approximately +48 Vdc. If it does, the MDU-100 is operating properly. If it does not, check all input connections to the MDU-100, and recheck the voltage. Also ensure that you are measuring between pins 1 and 2, and that the probe leads are making contact with the pin metal. If you still do not measure 48 V, the MDU-100 may need to be returned to Satlantic.



 <b>Operation Manual</b>	SYSTEM <p style="text-align: center;"><b>HyperSAS</b></p>
	SECTION <p style="text-align: center;"><b>G. MAINTENANCE</b></p>

### Check Cable Continuity

Often, system problems can be traced to cable breaks or shorts. Usually, these cable failures are a result of improper handling or storage. Cable continuity can be checked as outlined below. All cables should be disconnected from the instrument when performing these tests.

Note: All Satlantic cables used in the HyperSAS are one-to-one, that is, pin 1 on the connector on one end of the cable is connected to pin 1 on the connector on the other end of the cable. On the power-telemetry cable, there is a 6-pin female connector on one end and a 4-pin male connector on the other. The unused pins on the 6-pin (pins 5 and 6) are simply not connected.

### Procedure

1. Set the multimeter to measure continuity. The resistance measurement setting can also be used.
2. Check for continuity by measuring from pin 1 on one end of the cable to pin 1 on the other end. The meter should confirm that the connection is continuous by either giving an audible signal or measuring a low resistance. If there is not continuity, there is a break in the cable requiring repair.
3. Repeat step 2 for all pins in the cable.

Check for shorts from pin 1 to all other pins by keeping one probe lead on pin 1 and touching the other probe lead to each of the other pins in the same connector in turn. All pins should be isolated from each other. The meter should read this as open or measure a very high resistance. If any of the pins are not isolated, there is a short in the cable that requires repair.

 <b>Operation Manual</b>	SYSTEM <p style="text-align: center;"><b>HyperSAS</b></p>
	SECTION <p style="text-align: center;"><b>H. WARRANTY</b></p>

## H. WARRANTY

### Warranty Period

The HyperSAS is under *one year* parts and labour warranty from date of delivery.

### Restrictions

Warranty does not apply to products that are deemed by Satlantic to be damaged by misuse, abuse, accident or modifications by the customer. The warranty is considered void if any optical or mechanical housing is opened. In addition, the warranty is void if the warranty seal is removed, broken or otherwise damaged.

### Provisions

During the one year from date of delivery warranty period, Satlantic will replace or repair, as deemed necessary, components that are defective, except as noted above, without charge to the customer.

### Returns

To return products to Satlantic, whether under warranty or not, contact Satlantic, Customer Support Department and request a Returned Material Authorization (RMA) number and provide shipping details. All claims under warranty must be made promptly after occurrence of circumstances giving rise thereto and must be received by Satlantic within the applicable warranty period. Such claims should state clearly the product serial number, date of purchase (and proof thereof) and a full description of the circumstances giving rise to the claim. All replacement parts and/or products covered under the warranty period become the property of Satlantic Inc.

### Liability

**IF THE HYPER SAS SHOULD BE DEFECTIVE OR FAIL TO BE IN GOOD WORKING ORDER THE CUSTOMER'S SOLE REMEDY SHALL BE REPAIR OR REPLACEMENT AS STATED ABOVE. IN NO EVENT WILL SATLANTIC INC. BE LIABLE FOR ANY DAMAGES, INCLUDING LOSS OF PROFITS, LOSS OF SAVINGS OR OTHER INCIDENTAL OR CONSEQUENTIAL DAMAGES ARISING FROM THE USE OR INABILITY TO USE THE HYPER SAS OR COMPONENTS THEREOF.**

 <b>Operation Manual</b>	SYSTEM <p style="text-align: center;"><b>HyperSAS</b></p>
	SECTION <p style="text-align: center;"><b>I. CONTACT INFORMATION</b></p>

## I. CONTACT INFORMATION

If you have any problems, questions, suggestions or comments about the instrument or manual, please contact us.

### Location

#### **Satlantic Inc.**

Richmond Terminal, Pier 9  
 3481 North Marginal Road  
 Halifax, Nova Scotia  
 B3K 5X8 Canada

PHONE: (902) 492-4780  
 FAX: (902) 492-4781.

Email: [support@satlantic.com](mailto:support@satlantic.com)

Web: <http://www.satlantic.com>

### Business Hours

Satlantic is normally open for business between the hours of 9:00 AM and 5:00 PM Atlantic Standard Time. The Atlantic Standard Time zone is one hour ahead of the Eastern Standard Time zone. Normally, in the winter, AST is UTC-4, but it changes to UTC-3 during the daylight saving time period in the summer. Daylight saving time is in effect from 2:00 AM on the first Sunday in April until 2:00 AM on the last Sunday in October.

Satlantic is not open for business during Canada's statutory holidays, which are as follows:

- New Year's Day                      January 1st
- Good Friday                         The Friday before Easter Sunday  
 (Easter Sunday is the first Sunday after the full moon on or following March 21<sup>st</sup>, or one week later if the full moon falls on Sunday)
- Victoria Day                         The first Monday before May 25<sup>th</sup>
- Canada Day                         July 1<sup>st</sup>
- Halifax Natal Day                    The first Monday in August
- Labor Day                            The first Monday in September
- Thanksgiving Day                 The second Monday in October
- Remembrance Day                 November 11<sup>th</sup>
- Christmas Day                      December 25<sup>th</sup>
- Boxing Day                         December 26<sup>th</sup>