

CS Submersible Fluorometer

User's Manual



June 29, 2012
P/N: 998-2300
Revision L

TURNER DESIGNS
845 W. Maude Ave.
Sunnyvale, CA 94085
Phone: (408) 749-0994
FAX: (408) 749-0998

C3 Submersible Fluorometer

Table of Contents

1. Introduction	
1.1 Introduction	4
1.2 Important Note Regarding the Use of the Fluorescein Sensor	4
2. Inspection and Setup	
2.1 Instrument Checklist	5
2.2 Optional Accessories	6
2.3 Identification	7
3. C-Soft Windows™ User Interface	
3.1 Software Installation and PC Requirements	9
3.1.1 Minimum PC Requirements	9
3.1.2 Software Installation	9
3.1.3 Integration / Interface Adapter Cable Installation	9
3.1.4 PC Software Interface	10
3.2 Software Operation	11
3.2.1 Settings Screen	11
3.2.2 Current Data and Calibration Screens	12
3.3 Calibration Procedures	
3.3.1 Direct Concentration Calibration	15
3.3.2 Raw Fluorescence Calibration – Blank Subtracted	16
3.3.3 Raw Fluorescence Calibration	17
3.3.4 Depth Calibration (Optional Accessory)	17
3.4 Log Setup Screen	18
3.5 Enabling Data Output Ready State	19
3.6 Downloading and File Management	20
4 Maintenance and Warranty	
4.1 Maintenance	22
4.1.1 Rinsing	22
4.1.2 Care for the Bulkhead Connector	22
4.2 Warranty Terms	22
4.3 Warranty Service	23
4.4 Out of Warranty Service	23
Appendices	
A Specifications	25
B Recommended Practices	26
C Wiring Guide	27
D Linear Range, Quenching and Temperature Considerations	28
E How to set up Hyperterminal for Digital (ASCII) Data Capture	29
F Integrator Firmware	31
G Campbell Scientific Datalogger Integration	32

C3 Submersible Fluorometer



WASTE ELECTRICAL AND ELECTRONIC EQUIPMENT (WEEE) DIRECTIVE

Turner Designs is in the business of designing and selling products that benefit the well-being of our environment. Accordingly, we are concerned with preserving the surroundings wherever our instruments are used and happy to work with customers by complying with the WEEE Directive to reduce the environmental impact resulting from the use of our products.

WEEE Return Process:

To arrange the return of an end-of-life product, proceed as follows:

If you purchased your instrument through a Turner Designs Distributor please contact your local representative. They will instruct you where to return the end-of-life product.

If you purchased your instrument directly from Turner Designs please contact Turner Designs Customer Service

By Phone: 1-408-212-4041 or Toll Free: (877) 316.8049

By Email: Customer Service at support@turnerdesigns.com

Turner Designs will provide a WEEE RMA Number, a Shipping Account Number, and a Ship to Address. Package and ship the product back to Turner Designs.

The product will be dealt with per Turner Designs' end-of-life recycling program in an environmentally friendly way.

C3 Submersible Fluorometer

1. Introduction

1.1 The C3 Submersible Fluorometer is manufactured according to users' optical specifications with one, two, or three optical sensors ranging in wavelengths from deep ultraviolet to infrared. Each optical sensor is designed with fixed excitation and emission filters. The C3 Submersible Fluorometer comes with a factory-installed temperature probe and can be configured with a pressure sensor for depth measurements up to 600 meters and/or a wiper to minimize biofouling. The C3 Submersible Fluorometer Windows™ based user interface allows for easy calibration of each sensor, digital data reporting, data logging and digital or analog export of data.

1.2 *Important Note Regarding Use of Fluorescein Optics:*

For C3's manufactured prior to 2/15/2011, the Fluorescein sensor should not be enabled for simultaneous data collection with Chlorophyll and/or Rhodamine sensors or it will produce unreliable results. For C3's manufactured after 2/15/2011 this interference issue was corrected. If you would like to send your C3 back to Turner Designs to resolve this interference issue, please contact sales@turnerdesigns.com

C3 Submersible Fluorometer

2. Inspection and Setup

2.1 Instrument Checklist

The C3 Submersible Fluorometer package P/N: 2300-000 includes:

- ◆ C3 Submersible Fluorometer
- ◆ Factory-installed temperature sensor
- ◆ Antifouling Copper Tape
- ◆ Interface cable for communicating with your PC and supplying power to the instrument
- ◆ Integration / Interface Adapter Cable (*see Appendix F and G for more information about integration*)
- ◆ USB Flash Drive including C-Soft software, user's manual, cable guide and quick start guide

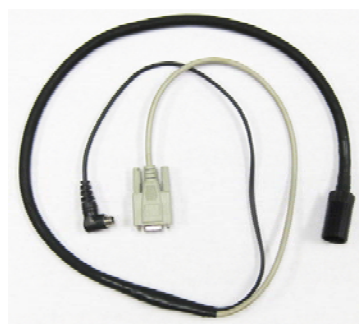

12V Power Supply



Antifouling Copper Tape

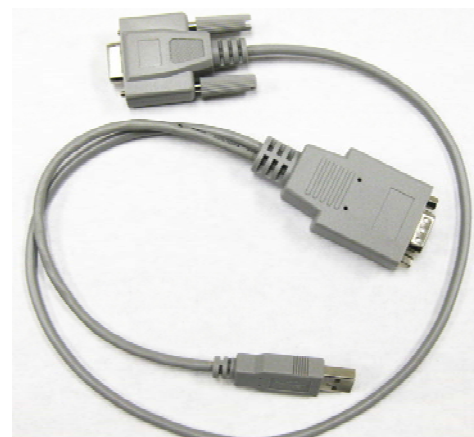

Integration / Interface Adapter Cable

C3 Submersible Fluorometer

2.2 Optional Accessories

- ◆ Pressure sensor P/N: 2300-360 *Factory-installed. Note: Can only be installed during the manufacturing of the unit.*
- ◆ C3 Mechanical Wiper P/N: 2300-450 *Factory-installed. Note: Can only be installed during the manufacturing of the unit. See Accessory Instructions on the USB Flash Drive for more information.*
- ◆ Replacement Wiper Brushes P/N: 2300-460
- ◆ Replacement Wiper Spacers P/N: 2300-462
- ◆ Antifouling Copper Tape P/N: 2300-506
- ◆ Rechargeable Submersible Battery Pack including charger P/N: 2200-601. *See Accessory Instructions on the USB Flash Drive for more information.*
- ◆ Battery Bracket P/N: 2300-603 **Note: Required for use with Battery Pack and Analog Output Adaptor.** *See Accessory Instructions on the USB Flash Drive for more information.*
- ◆ Flow Cap P/N: 2300-700. *See Accessory Instructions on the USB Flash Drive for more information.*
- ◆ Shade Cap P/N: 2300-500 or C-ray Shade Cap P/N: 2300-502
- ◆ Shade Cap Weight P/N: 2300-510
- ◆ C-ray Towed Deployment Body P/N 2300-750
- ◆ Extender Cables:
 - ◆ 10 meters P/N: 105-2595
 - ◆ 25 meters P/N: 105-2596
 - ◆ 50 meters P/N: 105-2597
 - ◆ Custom lengths available upon request
- ◆ Booster Kit P/N: 2200-900 **Note: Required for cable lengths greater than 10 meters.**
- ◆ 24" Pigtail Interface Cable with Locking Sleeve P/N: 2200-170
- ◆ Solid Secondary Standard Cap P/N: 2300-905
- ◆ Solid Secondary Standard (SSS) for *in vivo* Chlorophyll, Phycocyanin, Phycoerythrin, Rhodamine, and Fluorescein P/N: 2300-901. *See Accessory Instructions on the USB Flash Drive for more information.*
- ◆ Solid Secondary Standard (SSS) for UV Sensors - CDOM/FDOM, Optical Brighteners, Refined Fuels and Crude Oil P/N: 2300-902. *See Accessory Instructions on the USB Flash Drive for more information.*
Note: Solid Secondary Standard not available for turbidity.
- ◆ Analog Output Adapter P/N: 2300-480. *See Accessory Instructions on the USB Flash Drive for more information.*

C3 Submersible Fluorometer

Flow Cap



Shade Cap



Air Purge Slots



C-ray Towed Deployment Body

Battery Bracket



Submersible Battery



Mechanical Wiper

Booster Kit

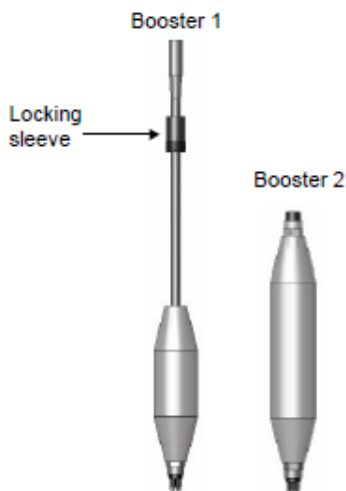

Solid Secondary Standard



Solid Secondary Standard Cap

C3 Submersible Fluorometer

2.3 Identification

Sensors are marked with numbers 1, 2, or 3 located adjacent to the optics on the face of the C3 Submersible Fluorometer. These numbers correspond to channels 1, 2, and 3 in C-Soft (C3 software). **Note: Channel names can be modified using C-Soft.**

Light emitting diode color table.

Application	Light Source Color
<i>In Vivo</i> Chlorophyll	Blue
Turbidity	Infra Red (No Color)
Phycocyanin	Yellow-Orange
Phycoerythrin	Green
Fluorescein	Blue (See important note on page 5)
Rhodamine	Green
CDOM/FDOM	Ultra Violet (No Color)*
Refined Oils and Fuels	Deep Ultra Violet (No Color)*
Crude Oil	Ultra Violet (No Color)*
Optical Brighteners	Ultra Violet (No Color)*
PTSA	Ultra Violet (No Color)*

***Do not look directly at the optics. Ultraviolet light can be damaging to the eyes.**

C3 Submersible Fluorometer

3. C-Soft Windows™ User Interface

The C-Soft Windows™ based user interface allows for intuitive calibration, data logging, set up, and download functions.

3.1 Software Requirements and PC Installation

3.1.1 Minimum PC Requirements

- ◆ 133MHz microprocessor
- ◆ 600 X 800 VGA resolution
- ◆ Microsoft Windows™ 98
- ◆ 32 MB RAM

3.1.2 Software Installation

1. Exit all Windows™ programs
2. Insert the *USB Flash Drive* (also located on the Turner Designs Software / Firmware webpage under Customer Care).
3. Open the C-Soft software folder and double click on the setup icon.
4. The software will automatically be installed in the PC's (C:/Program Files/C-Soft) folder unless user selects alternate location.
5. After restarting the PC the "C-Soft" icon is located on the desktop.



C-Soft Note: You may receive a warning message asking if you want to unblock messages, select "Unblock".

3.1.3 Integration / Interface Adapter Cable Installation

1. Insert the USB Flash Drive and install the Adapter Cable driver (Integration-Interface_Adapter_Drivers.exe) onto your PC.
2. Make sure nothing is plugged into the Adapter Cable's connectors.
3. Plug the USB connector into a USB port on your computer and wait for hardware to automatically install.
4. Once USB is installed and ready to use, right click the My Computer icon. **Note: For Windows Vista or 7 users, open the start menu and right click on Computer.**
5. Left click "properties" to open the properties window.
6. If running Windows XP or older versions of Windows, click on the "Hardware" tab and then click "Device Manager" to open the list of devices installed on your computer. **Note: For Windows Vista or 7 users, the Device Manager link is located in the upper left part of the properties window; you will not see a Hardware tab.**

C3 Submersible Fluorometer

7. Scroll down and open the “Ports” heading from the list.
8. The newly installed Adapter will be titled “USB Serial Port” followed by a COM port designation in parentheses (for example, “(COM 5)”).
9. If the USB Serial Port’s COM designation is labeled as any number from 1-6, your installation is complete. Close all windows and make sure to set C-Soft to that specified COM designation when trying to connect via USB Adapter Cable connection.
10. If the USB Serial Port’s COM designation is greater than 6, right click on the “USB Serial Port” and click “properties” which will open up the properties menu. From that menu click on the “Port Setting” tab and then click “Advanced” which will open the advanced settings menu for that USB Serial Port. Choose any COM port 1-6 from the COM port pull-down menu and click “OK”. **Note: Ideally you want to start with any port that is not in use; if all are in use then choose any port 1-6.** Click “OK” to the warning box if it appears and Click “OK” to close any other open menus. Your installation is complete. Make sure to set C-Soft to that specified COM designation when trying to connect via USB Adapter Cable connection.

3.1.4 PC Software Interface

Note: It is important that the steps be followed IN ORDER. Any variance from the procedure may result in the connection NOT being established.

1. Plug either the USB or serial connector of the adapter cable into your computer.

Note: Either connection can be used for communicating and configuring the instrument.

2. Plug the interface cable onto the 8-pin bulkhead connector of the instrument.
3. Plug the interface cable’s serial plug into the adapter cable’s male serial plug.
4. Begin C-Soft by double-clicking on the C-Soft icon and choose the appropriate COM port from the pull down COM menu.
5. Plug the 12V power supply into a power source.
6. Wait for initialization process to complete.

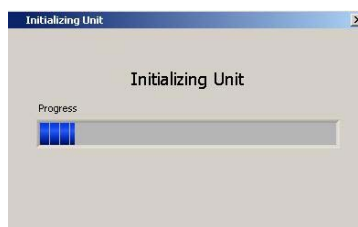

C3 Submersible Fluorometer

The connection icon, located on the upper right of the screen, will turn green if connected.

Note: If the connection icon does not turn green, disconnect and reconnect power.



3.2 Software Operation

3.2.1 Settings Screen

The Settings Screen allows users to set the time and date, identify each optical sensor, update serial numbers, and enable/disable sensors.

- ◆ Users can manually set the date and time or choose to synchronize the C3 Submersible Fluorometer to the PC date and time.
- ◆ Each channel (1-3) in the Settings Screen has a location associated with it on the C3 Submersible Fluorometer that is numerically labeled (1-3), respectively. Channels 4-6 are designated for the C6 Multi-Sensor Platform and are disabled for the C3.
- ◆ Click on the box adjacent to the channel to enable channel operation. If there is no sensor installed users will be unable to select that channel.
- ◆ Channels can be renamed using the dropdown selections or by manually entering a name.
- ◆ The serial number boxes are designed for the C6 Multi-Sensor Platform. There is no serial number associated with the sensors in the C3.
- ◆ Settings will automatically be saved after exiting the Settings screen.

C3 Submersible Fluorometer

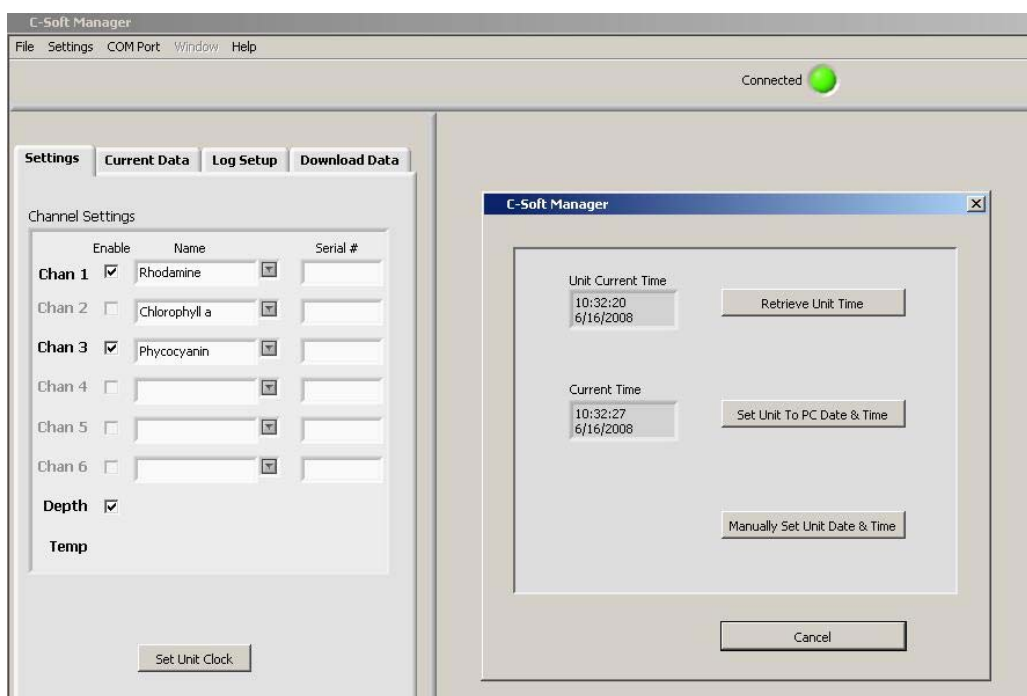

3.2.2 Current Data and Calibration Screen

The Current Data Screen allows users to view real-time data acquisition, in both tabular and waveform formats as well as conduct calibrations for each channel, and view calibration information.

Current Data

- ◆ Channel names are displayed but cannot be changed in the Current Data screen.
- ◆ Real-time values are displayed next to each channel and in the adjacent Data Table.
- ◆ A calibration button is available for each channel and the depth sensor.
- ◆ Real-time data can be saved by selecting the “Start Data Capture” button. Users will be prompted to enter a file name and file location. Data files will be saved as .csv format.

Tabular Screen

- ◆ Real-time data including date, time, units and temperature are continuously scrolling on the tabular screen for enabled channels.
- ◆ Channel names will appear in the associated column headings.
- ◆ If units are not selected during calibration, a relative fluorescence units (RFU) label will appear.

C3 Submersible Fluorometer

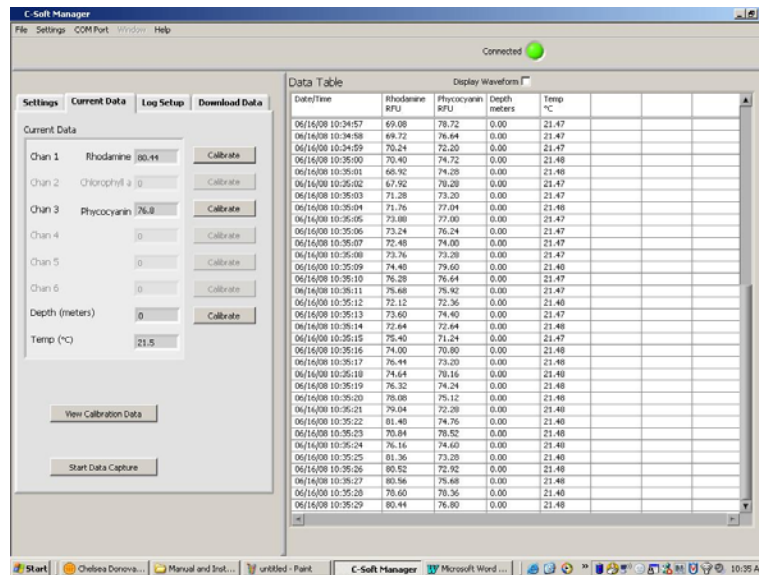

Waveform Screen

Users can graphically view real-time data for each sensor by clicking the “Display Waveform” box.

- ◆ Channel names and units will be displayed on the Y-axis.
- ◆ Time and date will be displayed on the X-axis.
- ◆ Clicking the “Autoscale” box will automatically scale graphs. Users may also rescale graphs by unchecking the “Autoscale” box and manually entering desired values for either Y or X axis ranges.
- ◆ Data can be saved during waveform mode by clicking “Start Data Capture”. Data files will be saved as .csv format.

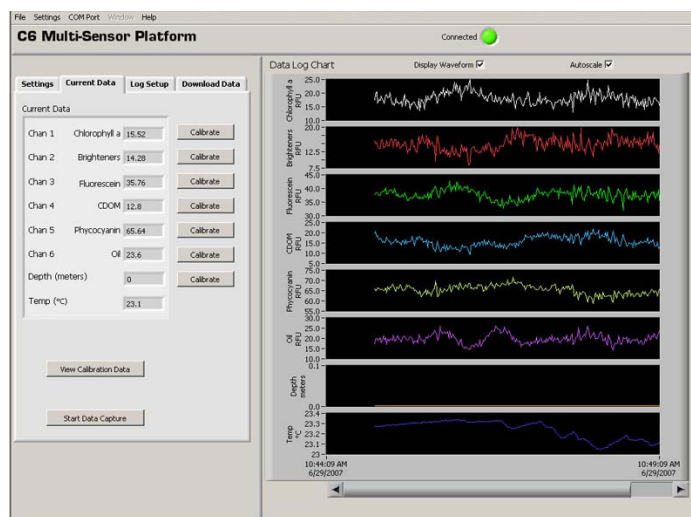

C3 Submersible Fluorometer

Calibration Screen

Users can calibrate sensors in either the direct concentration mode, raw fluorescence mode, or blank subtracted raw fluorescence mode.

The screenshot shows a window titled "C-Soft Manager" with a sub-window "Channel Calibration". At the top, there are two text boxes: "Unit Label" containing "Chan 1:Rhodamine" and "Current RFU" containing "03.20". Below this, the screen is divided into five steps:

- Step 1:** "Press 'Set Blank' to set the blank value to the current RFU." To the right, there are three input fields for "Blank RFU" with multipliers "x1", "x10", and "x100". A "Set Blank" button is to the right of the "x1" field.
- Step 2:** "Enter the value of your standard and select the units of measure." To the right, there is a "Standard Value" input field and a "Units" dropdown menu.
- Step 3:** "Press 'Set Standard' to set the standard value to the current RFU." To the right, there is a "Standard RFU" input field and a "Set Standard" button.
- Step 4:** "Optional: Click the temperature compensation box to activate." To the right, there is a "Temp Compensation" checkbox.
- Step 5:** "After calibration is complete press 'Save Calibration'." To the right, there are "Save Calibration" and "Cancel" buttons.

At the bottom of the window, there is a button labeled "Click to use uncalibrated Raw Fluorescence Mode".

Direct Concentration Mode

Values reported in the Direct Concentration Mode are scaled to a predetermined standard value and blank subtracted. The equation used to calculate concentrations after calibrating to Direct Concentration Mode is:

$$\frac{\text{Standard Value (units)}}{\text{Standard RFU}} \times \text{Sample RFU} = \text{Concentration (units)}$$

Raw Fluorescence Blank Subtracted Mode

Values in the Raw Fluorescence Blank Subtracted Mode are noted as RFUB. It is important to note that these values are blank subtracted but are not scaled to a standard; they are **relative** values.

Raw Fluorescence Mode

Values in the Raw Fluorescence Mode are referred to as "Relative Fluorescence Units" (RFU). It is important to note that these values are not blank subtracted or scaled to a standard; they are **relative** values.

C3 Submersible Fluorometer

3.3 Calibration Procedure

3.3.1 Direct Concentration Calibration

Following steps 1-5 below will ensure values are reported as blank subtracted Concentrations in units of choice. See Appendix B for recommended practices.

Step 1: Blanking

- ◆ Place the C3 Submersible Fluorometer in a blank solution.

Note: A blank solution is a solution without the fluorophore of interest (i.e. deionized water, artificial water, or filtered water).

Note: Ensure the optical head is free of air bubbles.

- ◆ Wait until “Current RFU” readings have stabilized then select the “Set Blank” button to set the blank value.
- ◆ Wait for the blank value to be measured and set for all 3 gains.

Step 2: Standard Value and Units

- ◆ Place the C3 Submersible Fluorometer in a standard solution or use a solid secondary standard. See Accessory Instructions on the USB Flash Drive for additional information.

Note: Turbidity sensors do not have solid secondary standards

- ◆ Enter the known concentration value of the standard solution or solid standard in the “Standard Value” box. If the concentration is not known, enter an arbitrary value.
- ◆ Enter manually or select desired units from the dropdown menu.
Note: Do not choose or enter “RFUB” if Direct Concentration Mode is preferred.

Step 3: Set Standard

- ◆ When readings in “Current RFU” box have stabilized, select the “Set Standard” button.

Step 4: Optional Temperature Compensation

Temperature compensation is optional; it enables the C3 to compensate for changes in fluorescence due to varying temperatures as detected by the C3’s temperature sensor. Temperature compensation is available for *in vivo* Chlorophyll and Rhodamine sensors only. Temperature is displayed in degree Celsius.

- ◆ Click on the “Temperature Compensation” box.
- ◆ Select either *in vivo* Chlorophyll or Rhodamine from the dropdown menu.

C3 Submersible Fluorometer

- ◆ Data will now be corrected for temperature fluctuations.

The temperature compensation coefficients for each fluorophore are listed in the table below.

Fluorophore	Coefficient
Rhodamine	0.026 / °C Exponential
<i>in vivo</i> Chlorophyll	0.014 / °C Linear

Step 5: Save Calibration

- ◆ After calibration is complete, select “Save Calibration”.
- ◆ Data are now displayed as concentration estimates.

3.3.2 Raw Fluorescence Calibration – Blank Subtracted

Following steps 1-5 below will ensure values are reported as Blank subtracted Relative Fluorescence Units (RFUB). See Appendix B for recommended practices.

Step 1: Blanking

- ◆ Place the C3 Submersible Fluorometer in a blank solution.

Note: A blank solution is a solution without the fluorophore of interest (i.e. deionized water, artificial water, or filtered water).

Note: Ensure the optical head is free of air bubbles.

- ◆ Wait until “Current RFU” readings have stabilized then select the “Set Blank” button to set the blank value.
- ◆ Wait for the blank value to be measured and set for all 3 gains.

Step 2: Selecting Units

- ◆ Select RFUB from the units’ dropdown menu.
Note: Do not enter a value in the standard value box.

Step 3: Skip and go to Step 4

Step 4: Optional Temperature Compensation – Follow same steps as the Direct Concentration Calibration procedure in Section 3.3.1.

Step 5: Save Calibration

- ◆ After calibration is complete select “Save Calibration”.
- ◆ Data are now displayed as blank corrected relative fluorescence units.

C3 Submersible Fluorometer

3.3.3 Raw Fluorescence Calibration

In the Current Data screen select the “calibrate” button next to a specific channel. At the bottom of the Calibration Screen select, “Click to use uncalibrated Raw Fluorescence Mode”. Data for that channel will be uncalibrated and reported as “Relative Fluorescence Units” (RFU).

3.3.4 Depth Calibration (Optional Accessory)

Note: Make sure your instrument is calibrated for depth and there is a value set even if you do not have a depth sensor.

Depth is displayed in meters only. There are two calibration options for depth:

1. The first uses only the atmospheric pressure as an offset. This is suitable for any shallow application, including most fresh water applications.
2. The second also compensates for gravity variations with latitude, as designated from the UNESCO Technical Papers in Marine Science #44 <http://unesdoc.unesco.org/images/0005/000598/059832EB.pdf>. This method assumes 0 °C and 35PSU salinity.

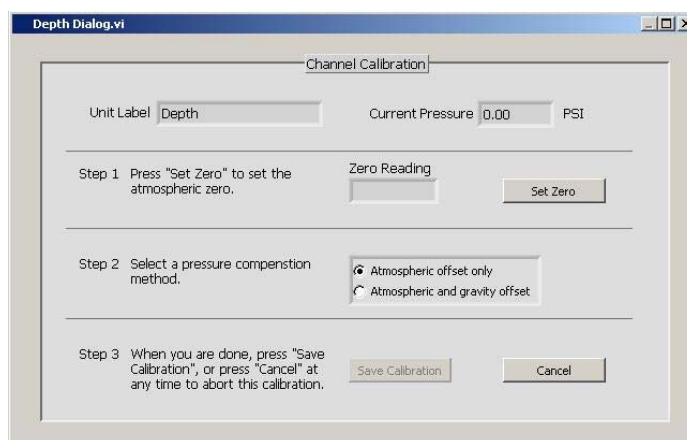

Atmospheric Offset (Method 1)

Step 1:

- ◆ Select the “Calibrate” button for depth in the “Current Data” screen.
- ◆ Pressure in PSI will be displayed in the “Current Pressure” window.
- ◆ After “Current Pressure” readings are stable at desired location select “Set Zero”.

Step 2:

- ◆ Select “Atmospheric offset only”.

Step 3:

- ◆ Select “Save Calibration” button.
- ◆ Depth values will now be scaled to the offset selected.

C3 Submersible Fluorometer

Atmospheric and Gravity Offset (Method 2)

Step 1:

- ◆ Select the “Calibrate” button for depth in the “Current Data” screen.
- ◆ Pressure in PSI will be displayed in the “Current Pressure” window.
- ◆ After “Current Pressure” readings are stable, at desired location, select “Set Zero”.

Step 2:

- ◆ Select “Atmospheric and gravity offset”.
- ◆ Enter the latitude.

Step 3:

- ◆ Select “Save Calibration” button.
- ◆ Depth values will now be scaled to the offset selected.

3.4 Log Setup Screen

The Log Setup screen allows the user to configure a logging session, set the mechanical wiper to its home position, and enable logging. The C3 Submersible Fluorometer can log just over 64,000 lines of data.

Enter a log start date (MM/DD/YYYY) and time (HH:MM:SS).

- ◆ Enter the sampling interval (HH:MM:SS). The minimum sampling interval is 1 second.

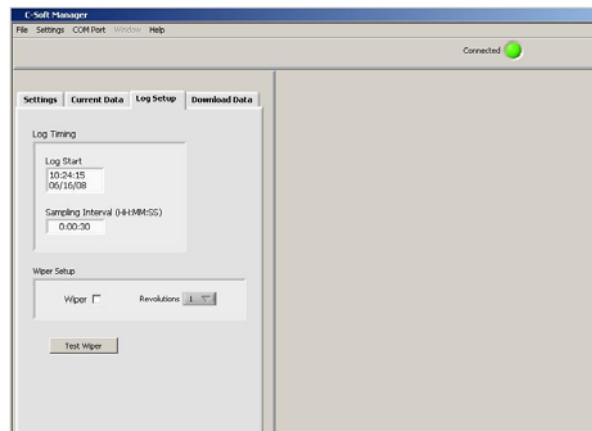

- ◆ If the mechanical wiper is installed click the “Wiper” box to enable.
- ◆ Select the number of revolutions from the dropdown box (1-10 revolutions). All sensors will be wiped at specified revolutions before each measurement.

Note: If users select revolutions that exceed sampling interval a warning message will be displayed.

C3 Submersible Fluorometer

Note: Do not click the Wiper Box to enable wiper if the wiper is not installed.

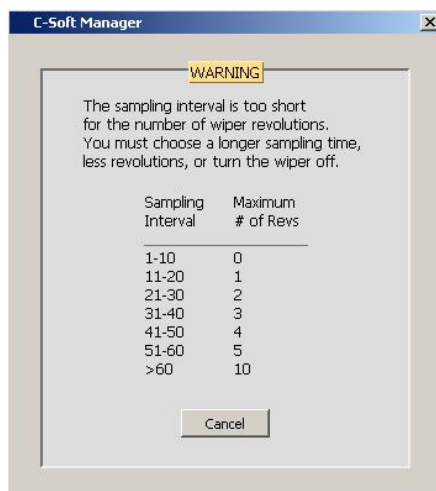

- ◆ After log set up is complete select “Enable Datalog” (see section 3.3 “Enabling Data Output Ready State”).
- ◆ A prompt will appear asking if user is ready to enable logging, select “Yes”.

Note: If data logging is set to start for a time in the past, there will be a minimum delay of 100 seconds before startup after power has been supplied. Otherwise wait until the data logging start time has been reached for data logging to begin.

WARNING! As soon as data logging is enabled users will be unable to access C-Soft settings. This should be the last step before the C3 Submersible Fluorometer is deployed.

3.5 Enabling Data Output Ready State

The Data Output Ready State must be enabled for the C3 Submersible Fluorometer in order to log data, capture real-time data output, and/or integrate the C3 with other instrumentation (see Appendix F and G for more information about integration). There are five necessary steps to ensure the instrument is properly set up for data output:

1. Set the instrument’s clock to PC or local time in the Settings Tab.
2. Select the sensors you expect to use during sampling.
3. Calibrate selected sensors for either Direct Concentration Mode or Raw Fluorescence Units Blanked (RFUB) Mode (see section 3.3).
4. Set the start time, sampling, and wiping intervals in the Log Setup Tab. **Note: Wiping interval is optional and depends on the sampling interval (see section 3.4).**
5. Click the ‘Enable Datalog’ button followed by the ‘Yes’ button to enable the Data Output Ready State.

C3 Submersible Fluorometer

Note: Use the Battery Life Calculator available on the Turner Designs website C3 product page to calculate a conservative estimation of how many days you can expect to log data. Factors such as battery charge and water temperature will affect logging days.

A few seconds after the 'Yes' button has been clicked to enable the Data Output Ready State, the C-Soft program will automatically shut down and users must disconnect power and serial connections. The instrument is now in the Data Output Ready State and will remain in that state so long as C-Soft is not used to communicate with the instrument. **Note: As soon as C-Soft is used to communicate with the instrument, users will need to re-set the parameter settings in the Log Setup (section 3.4) and again enable datalog to put the instrument into the Data Output Ready State.**

When power is supplied to the instrument while it is in the Data Output Ready State, it will begin streaming data after a 100 second delay. If power is cycled (i.e. disconnected and reconnected) please allow 100 seconds for the data stream to begin. **Note: Check the optical face when power is supplied to make sure the sensors light. The sensor will turn on, then off and then turn back on in 100 seconds. If this sequence does not happen, cycle power.**

3.6 Downloading and File Management

Users can download new and existing files saved in the C3 Submersible Fluorometer memory.

- ◆ Select Download Data.
Note: This step may take up to 10 minutes depending on file size.
- ◆ When download has completed choose the files to be saved by clicking the "Save" box.
- ◆ Users will be prompted to choose a folder location where data will be saved.
- ◆ Files will be saved in .csv format.
- ◆ Select "Clear Datalog" to erase existing data from memory.
- ◆ Users are able to graphically view downloaded .csv data files using C-Soft software if desired.

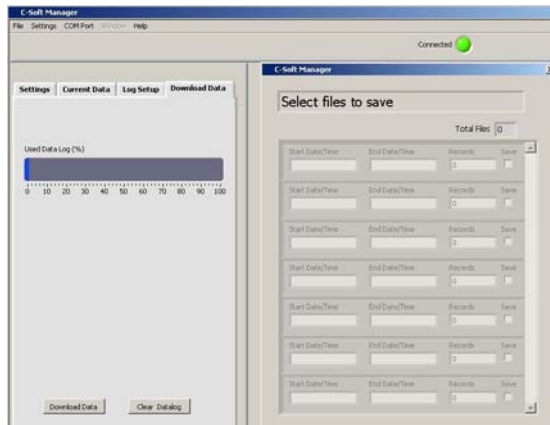

C3 Submersible Fluorometer

Note: If you have problems downloading data in C-Soft, you may have limited space in the cache memory on your computer. If you have not done a Disk Cleanup for awhile you may want to try and see if that clears up the problem and allows you to download files. Disk Cleanup can be found in the following location on most Windows versions:

Start Menu → All Programs → Accessories → System Tools → Disk Cleanup

Once the initial scan of the computer is complete, customers should select all the check boxes and select OK to perform the cleanup.

C3 Submersible Fluorometer

4. Maintenance and Warranty

4.1 Maintenance

4.1.1 Rinsing

The C3 Submersible Fluorometer should be rinsed or soaked in freshwater following each deployment.

4.1.2 Care for the bulkhead connector

Install the 8-pin female end plug to the bulkhead between uses. A light coat of Silicone spray should be used on the rubber of the male pins of the bulkhead to aid in sealing. The manufacturer recommends 3M™ Silicone Lubricant Spray or Loctite 8021 spray. **Note: You should avoid using silicone grease. Do NOT use WD-40, it will destroy the connectors.**

4.2 Warranty Terms

Turner Designs warrants the C3 and accessories to be free from defects in materials and workmanship under normal use and service for a period of 12 months from the date of shipment from Turner Designs with the following restrictions:

- Turner Designs is not responsible for replacing parts damaged by accident or neglect. Your instrument must be installed according to instructions in the User's Manual. Damage from corrosion is not covered. Damage caused by customer modification of the instrument is not covered.
- This warranty covers only Turner Designs products and is not extended to equipment used with our products. We are not responsible for accidental or consequential damages, except in those states where this limitation is not allowed. This warranty gives you specific legal rights and you may have other rights which vary from state to state.
- Damage incurred in shipping is not covered.

C3 Submersible Fluorometer

4.3 Warranty Service

To obtain service during the warranty period, the owner shall take the following steps:

1. Write, email or call the Turner Designs Technical Support department and describe as precisely as possible the nature of the problem.

Phone: 1 (877) 316-8049

Email: support@turnerdesigns.com

2. Carry out any adjustments or tests as suggested by the Technical Support Department.
3. If proper performance is not obtained you will be issued a Return Materials Authorization number (RMA) to reference. Package the unit, write the RMA number on the outside of the shipping carton, and ship the instrument, prepaid, to Turner Designs. If the failure is covered under the warranty terms, the instrument will be repaired and returned free of charge, for all customers in the contiguous continental United States.

For customers outside of the contiguous continental United States who purchased equipment from one of our authorized distributors, contact the distributor. If you purchased directly, contact us. We will repair the instrument at no charge. Customer pays for shipping, duties and documentation to Turner Designs. Turner Designs pays for return shipment (custom duties, taxes and fees are the responsibility of the customer).

4.4 Out-of-Warranty Service

Follow steps for Warranty Service as listed above. If our Technical Support department can assist you by phone or correspondence, we will be glad to, at no charge. Repair service will be billed on a fixed price basis, plus any applicable duties and/or taxes. Shipment to Turner Designs should be prepaid. Your bill will include return shipment freight charges.

Address for Shipment:

Turner Designs, Inc.
845 W. Maude Ave.
Sunnyvale, CA 94085

C3 Submersible Fluorometer

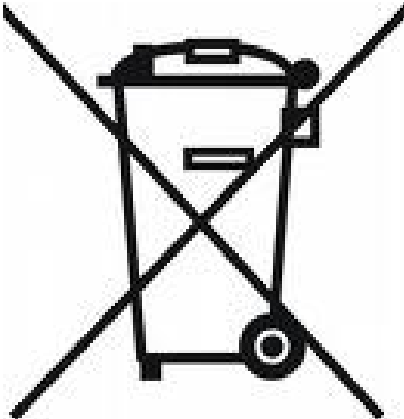

C3 Submersible Fluorometer

Appendix A: Specifications

C3 Submersible Fluorometer	
Weight in Air	1.64 kg (3.6 lbs)
Length	23 cm (9.1 in.)
Diameter	10 cm (3.9 in.)
Material	Delrin
Temperature	-2 to 50 °C
Temperature Accuracy	0.5 °C
Temperature Resolution	0.1
Depth	0-600 meters
DC Power Required	8 to 30 volts; 2.2 amperes
Maximum Current Draw at 12 volts	Operational = 200 mA
	Sleep = 3 mA
Minimum Sampling Interval	1 second
Signal Output	Digital (ASCII) or Analog (<i>Note: analog requires accessory</i>)
Interface	RS232 (USB Adapter)
Nonvolatile Memory	64,000 Data Lines

Submersible Battery Pack	
Battery	Lithium-Ion
Weight in Air	0.75 kg (1.65 lbs)
Weight in Water	0.22 kg (0.50 lbs)
Length	13.46 cm (5.3 in.)
Diameter	7 cm (2.75 in.)
Material	Delrin
Temperature	-2 to 50 °C
Depth	0-600 meters
Capacity	2,200 mAH
Voltage Output	14.8V nominal
Protection Features	Protects against: overcharge, over-discharge, overheating, short-circuiting

C3 Submersible Fluorometer

Appendix B: Recommended Practices

Identification

Sensors are labeled 1, 2 or 3 adjacent to the optics on the face of the instrument. Each channel is factory set in the C3 Windows Software.

Note: The channel labels can be modified in the C-Soft software.

Recommended Measurement Practices

The following steps will improve the accuracy and repeatability of your measurements, especially at low concentration levels:

1. Use a dark plastic or glass container for your standards and/or samples.
Note: Some plastics may fluoresce and might interfere with measurements.
2. If using a glass beaker, place it on a non-reflective surface, preferably black.
3. Ensure that the sensor is **>3 inches above the bottom** of the container.
4. Ensure that the sensor is in the center of the container, and has **>2 inches clearance** between the sensor and the inside surface of the container.
5. If using a glass beaker, check if the optical surface of the sensor is free of air bubbles. Remove air bubbles if any are observed. If using a dark plastic container, run the wiper or your finger over the optical sensors to ensure the sensor heads are free of air bubbles.

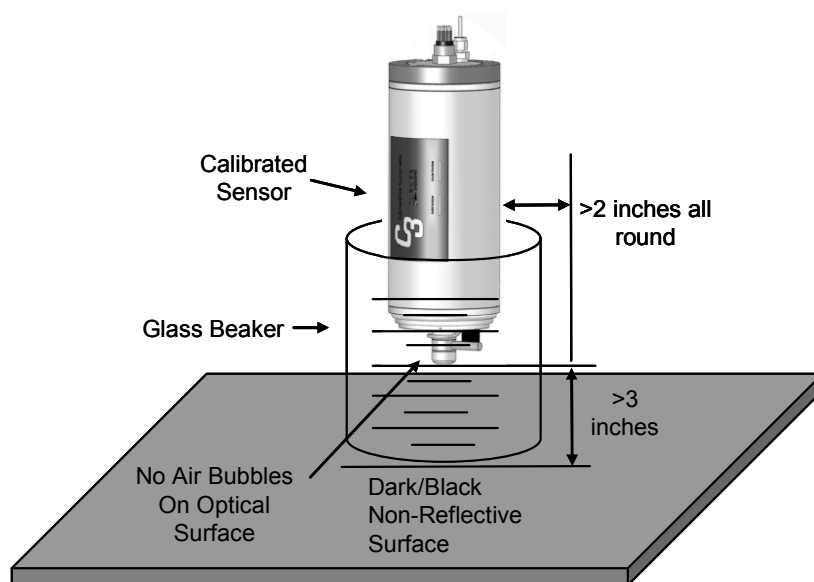

C3 Submersible Fluorometer

Appendix C: Wiring Guide

The C3 Submersible Fluorometer outputs digital data in three formats: 1) Digital data that can only be read by C3 Submersible Fluorometer’s software, 2) Digital data in ASCII format that can be read by larger multi parameter systems such as CTD’s, and 3) Digital data that can be read and converted to analog data by the C-Series Analog Adapter for output to an external datalogger or multimeter.

An 8-pin Impulse cable provides two end connections: 1) a 9-pin RS232 serial port for connection to a PC or laptop computer and 2) a 12V port for supplying power to the unit.

C3 Submersible Fluorometer bulkhead and serial port connectors

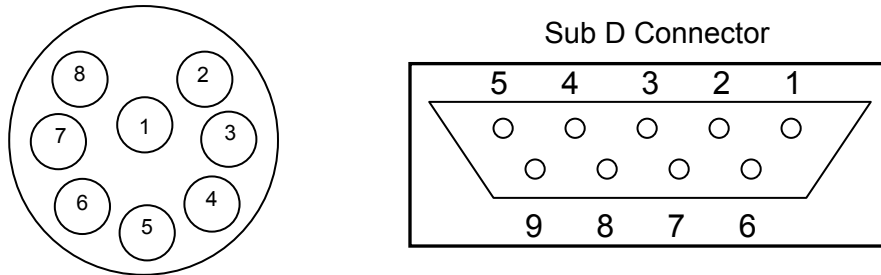

Wire Guide

Pin Out	Color	C3 Function	Corresponding Sub D Connector Pin
1	Black	V BATT (+)	Power Connector Cable – Center Pin (+)
2	White	V BATT (-)	Power Connector Cable – Housing (-)
3	Red	GND	PIN 5
4	Green	RX	PIN 2
5	Blue	TX	PIN 3
6	Brown	DTR & DSR	PIN 4, 6
7	Yellow	RTS & CTS	PIN 7, 8
8	Orange	N/A	N/A

**Power ground and V Batt (-) are not common.*

C3 Submersible Fluorometer

Appendix D: Linear Range, Quenching and Temperature Considerations

The linear range is the concentration range in which the C3 sensor output is directly proportional to the concentration of the signal. The linear range begins with the smallest detectable concentration and spans to an upper limit (concentration) that is dependent upon the properties of the material, filters used, and path length.

A non-linear relationship is seen at very high concentrations where the signal does not increase at a constant rate in comparison to the change in concentration (see figure below). At even higher concentrations, the signal will decrease even though the sample concentrations are continuing to increase. This effect is known as “signal quenching”.

Linearity can be checked by diluting a sample 1:1 or some other convenient ratio. If the sample is still in the linear range, the reading will decrease in direct proportion to the dilution. If the reading does not decrease in direct proportion to the dilution or if the reading increases, the sample is beyond the linear range.

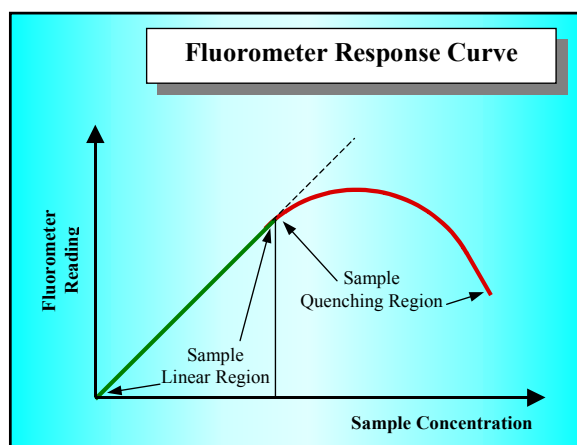

Graph showing Linear and Quenching Regions of the sample's response

Temperature Considerations

Fluorescence is temperature sensitive. As the temperature of the sample increases, the fluorescence decreases. For greatest accuracy, record the sample temperature and correct the sensor output for changes in temperature.

For further information on how temperature, light, water quality and the physiological state of the algal cells can all affect the measurement of chlorophyll, please refer to the application section of Turner Designs' website.

C3 Submersible Fluorometer

Appendix E: How to set up Hyperterminal for Digital (ASCII) Data Capture

1. Ensure C-Soft program is not running in the background. On an MS Windows computer, open the HyperTerminal program
Start→All Programs→Accessories→Communications→HyperTerminal
2. The **Connection Description** screen will appear. Name the connection description. This file will save the communication parameters for the C3 Submersible Fluorometer and can be used in the future to establish communication with the instrument quickly.
3. The **Connect To** screen will appear. Choose the appropriate communications port in the **Connect Using** window. Click **OK**.
4. The **Port Settings** screen will appear. Choose the following port settings:

Bits per second: 9600
Data bits: 8
Parity: None
Stop bits: 1
Flow control: Hardware
Click **Apply** and **OK**

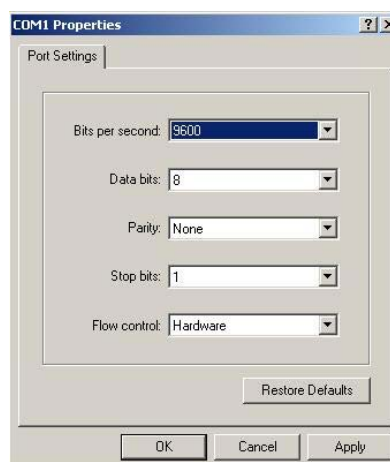

5. Next, the **HyperTerminal** window will appear. You are now ready to connect the C3 Submersible Fluorometer to a power source. Data will be displayed at set intervals in the HyperTerminal window after 100 seconds or at the specified log start time.

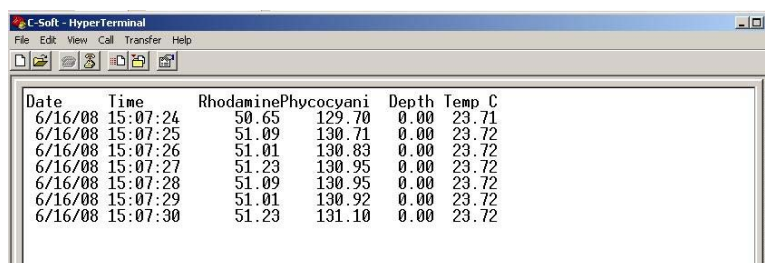

Date	Time	Rhodamine	Phycocyanin	Depth	Temp C
6/16/08	15:07:24	50.65	129.70	0.00	23.71
6/16/08	15:07:25	51.09	130.71	0.00	23.72
6/16/08	15:07:26	51.01	130.83	0.00	23.72
6/16/08	15:07:27	51.23	130.95	0.00	23.72
6/16/08	15:07:28	51.09	130.95	0.00	23.72
6/16/08	15:07:29	51.01	130.92	0.00	23.72
6/16/08	15:07:30	51.23	131.10	0.00	23.72

C3 Submersible Fluorometer

Most applications will integrate streaming data. Below are instructions on how to save streaming data on a PC.

To save data:

1. On the HyperTerminal window toolbar, choose Transfer and then Capture Text.

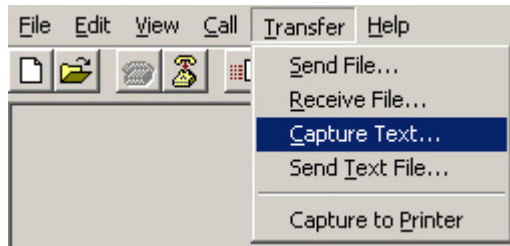

2. When you click on Capture Text, a window will appear asking you to **name** and **save** the **.txt** file to the location of interest.

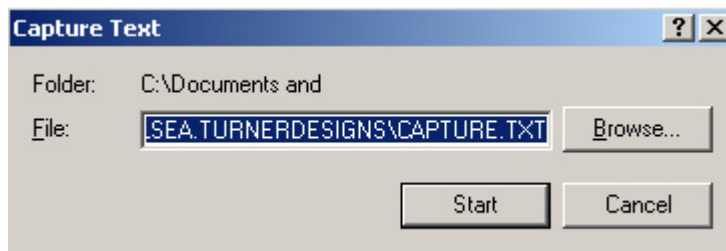

3. Once you are finished, you will need to return to the HyperTerminal window toolbar, choose **Transfer** and then **Capture Text** and select **Stop**. This will stop data capture to the **.txt** file.

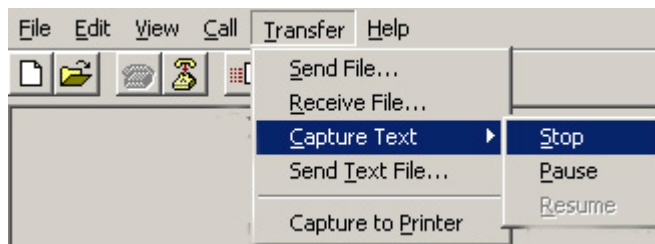

C3 Submersible Fluorometer

Appendix F: Integrator Firmware

Turner Designs offers Integrator Firmware. This firmware is designed for use by customers that are integrating their C3 with an external datalogger, CTD or similar system. The Integrator Firmware is different from the standard C3 firmware and has some features that users need to consider before installing:

1. Internal datalogging is **NOT** possible with this version of firmware. The Integrator Firmware is intended for data output only.
2. The data output rate defined by this Integrator Firmware is 1 second and cannot be changed to reflect longer or shorter data output rates.
3. Once power is applied there is a 15 second delay before data output starts at a 1 second interval.
4. If the wiper is enabled, it will rotate the set number of rotations upon powering the instrument and every 5 minutes as long as power is continuously supplied.
5. Sleep mode is disabled; therefore as long as power is continuously supplied the instrument will continue to stream data at a 1 second interval.

Download Firmware on the Turner Designs website

<http://www.turnerdesigns.com/customer-care/software-a-firmware>

C3 Submersible Fluorometer

Appendix G: Campbell Scientific Datalogger Integration

Turner Designs and Campbell Scientific worked together to help our customers easily integrate the C3 Submersible Fluorometer with any of the CR800 or CR1000 series dataloggers. Simply follow the steps below to quickly set up your datalogger and begin data logging:

1. Download the .txt file that pertains to your datalogger series (see links below)
2. Upload that file to your Campbell Datalogger
3. Run the program using your Campbell Datalogger
4. Enable the 'Data Output Ready Mode' on your C3 (this will allow streaming of ASCII data at the set sample interval)
5. Plug your C3 into the datalogger and watch data stream or capture data using your datalogger

Download Firmware on the Turner Designs website

<http://www.turnerdesigns.com/customer-care/software-a-firmware>

NOTE: Be sure to use the Integration Cable or Integration/Interface Adapter Cable to plug the C3 Submersible Fluorometer into your datalogger; using the Standard Interface Cable may result in the loss of data or inability to communicate with your datalogger. Be sure to refer to the power requirements in Appendix A, under or over power to the instrument may result in damage and loss of data.