

R. Parson

SIO Ref. 72-78

VOLUME SCATTERING FUNCTIONS FOR SELECTED OCEAN WATERS

Theodore J. Petzold

Approved for public release; distribution unlimited

Final, Technical Report

October 1972

Contract No. XXXXXXXXXX
N62269-71-C-0676

Supported by

Naval Air Development Center
Warminster, Pennsylvania 18974

UNIVERSITY
OF
CALIFORNIA
SAN DIEGO



SCRIPPS
INSTITUTION
OF
OCEANOGRAPHY

VISIBILITY LABORATORY San Diego, California 92152

Security Classification

DOCUMENT CONTROL DATA - R&D

(Security classification of title, body of abstract and indexing annotation must be entered when the overall report is classified)

1. ORIGINATING ACTIVITY <i>(Corporate author)</i> University of California, San Diego Visibility Laboratory San Diego, California 92152		2a. REPORT SECURITY CLASSIFICATION UNCLASSIFIED	
		2b. GROUP	
3. REPORT TITLE VOLUME SCATTERING FUNCTIONS FOR SELECTED OCEAN WATERS			
4. DESCRIPTIVE NOTES <i>(Type of report and inclusive dates)</i> Final, Technical			
5. AUTHOR(S) <i>(Last name, first name, initial)</i> Petzold, Theodore J.			
6. REPORT DATE October 1972		7a. TOTAL NO. OF PAGES 82	7b. NO. OF REFS 1
8a. CONTRACT OR GRANT NO.  N62269-71-C-0676		9a. ORIGINATOR'S REPORT NUMBER(S) SIO Ref. 72-78	
b.		9b. OTHER REPORT NO(S) <i>(Any other numbers that may be assigned this report)</i>	
c.			
d.			
10. AVAILABILITY / LIMITATION NOTICES Approved for public release; distribution unlimited.			
11. SUPPLEMENTARY NOTES		12. SPONSORING MILITARY ACTIVITY Naval Air Development Center Warminster, Pennsylvania 18974	
13. ABSTRACT Volume scattering functions for three general types of natural ocean waters have been obtained and are presented here. The three types of water are (1) deep clear oceanic water, (2) nearshore ocean water, and (3) very turbid harbor water. Also included are the results of laboratory experiments using sea water, filtered fresh water, and artificial scattering and absorbing agents. The beam transmission was obtained for all waters investigated. A brief description of the instruments used is given.			

UNIVERSITY OF CALIFORNIA, SAN DIEGO
SCRIPPS INSTITUTION OF OCEANOGRAPHY
VISIBILITY LABORATORY
SAN DIEGO, CALIFORNIA 92152

VOLUME SCATTERING FUNCTIONS FOR SELECTED OCEAN WATERS

Theodore J. Petzold

Approved for public release; distribution unlimited

SIO Ref. 72-78

October 1972

Contract No. [REDACTED] N62269-71-C-0676

Principal Investigator: Seibert Q. Duntley

Final Report

Naval Air Development Center
Warminster, Pennsylvania 18974

Approved:



Seibert Q. Duntley, Director
Visibility Laboratory

Approved for Distribution:



William A. Nierenberg, Director
Scripps Institution of Oceanography

ABSTRACT

Volume scattering functions for three general types of natural ocean waters have been obtained and are presented here. The three types of water are (1) deep clear oceanic water, (2) nearshore ocean water, and (3) very turbid harbor water. Also included are the results of laboratory experiments using sea water, filtered fresh water, and artificial scattering and absorbing agents. The beam transmission was obtained for all waters investigated. A brief description of the instruments used is given.

PAGES 2, 14, 24, 28, and 32 ARE BLANK IN THE ORIGINAL AND ARE OMITTED FROM THE PDF.

CONTENTS

ABSTRACT	iii
1. INTRODUCTION	1
2. DESCRIPTION OF THE INSTRUMENTS	3
2.1 Low Angle Scattering Meter	3
2.2 General Angle Scattering Meter	7
2.3 Transmissometer	11
3. CALCULATIONS	15
3.1 Volume Scattering Function, $\sigma(\theta)$	15
3.2 Volume Scattering Function Correction	16
3.3 Computation of the Total Volume Scattering Coefficient, s	19
3.4 Determination of the Angle θ for the Low Angle Scattering Meter Data	20
4. VALIDATION EXPERIMENT	25
5. DESCRIPTION OF DATA PRESENTATION AND COMMENTS	29
5.1 Volume Scattering Function Curves	29
5.2 Probability Curves	30
5.3 Scattering Data Tabulation	30
6. DATA PRESENTATION	33
7. DISCUSSION	77
ACKNOWLEDGMENTS	79

1. INTRODUCTION

The Visibility Laboratory has, under previous contract with the Naval Air Development Center (NADC), Warminster, Pennsylvania, developed and constructed two instruments to measure the volume scattering function of water. These two instruments, plus a transmissometer, were used during 1972 to gather data on the optical properties of various waters. It is the purpose of this final report, under Contract No. [REDACTED] to present the results obtained from these measurements.

N62269-71-C-0676

The work in the Tongue of the Ocean, Bahama Islands, was performed to determine the pertinent optical properties of the water during the time NADC was conducting a test program. The data from the waters off southern California and in San Diego Harbor, obtained during other laboratory project work, are included to show these same properties for two other types of water. Three general types of water are covered: deep clear oceanic water (Tongue of the Ocean), nearshore ocean water (off southern California), and very turbid harbor water (San Diego Harbor). The measurements made in the laboratory were performed to demonstrate the validity of the *in situ* scattering measurements and to obtain scattering measurements under laboratory conditions for comparison with the data obtained from shipboard.

2. DESCRIPTION OF THE INSTRUMENTS

A summary description of the instruments used to collect the data is given in this section.

2.1 LOW ANGLE SCATTERING METER

This instrument was designed and constructed under contract with NADC in 1966. Its purpose is to determine the volume scattering function for small angles. It was used by Robert E. Morrison of NADC during 1966 and the resultant data are included in NADC Report No. NADC-AE-6918. Subsequent development and testing has led to modifications in both the photometric and optical systems and the instrument is considerably improved in its reliability and precision.

The optics were modified to better define the limits of the solid angle of the measurement, to reduce scattering within the instrument, and to permit operation of the instrument in air in order to determine the scattering contributed by the optical system. Even though care was taken to reduce the instrument's own internal scattering, it is still significant relative to the small angle forward scattering of clear waters, and its magnitude must still be known and accounted for if erroneous high values for the small angle forward scattering are to be avoided.

The instrument is shown in Fig. 1 and a schematic drawing of the optical system is in Fig. 2. The projector, which has a small point source of light at the focal point of a long focal-length lens, produces a beam of highly collimated light. (The projected beam has a 1/4 milliradian half-angle divergence in water.) After traversing the sample path, the light enters an identically long focal-length lens in the receiver and an image of the point source is formed at its focal point. The light which traverses the water and is neither absorbed nor scattered will fall within this small image. Light which is scattered will arrive at the image plane displaced from the axis at a distance proportional to the angle through which it has been scattered and to the focal length of the receiver lens. In the plane of this image lies a disk with four special field stops which can be sequentially indexed into position by remote control through the cable. The first field stop is a small hole which allows the light in the image of the source to reach the detector (a photomultiplier tube positioned behind the field stop). The other three field stops are annuluses. The annuluses have a circular opaque center surrounded first by a clear ring and then by an opaque area. The inner and outer radii of the annuluses determine the angular interval over which the scattered light is

accepted and allowed to pass through to the photomultiplier tube. The nominal limits for the field stops in terms of angular acceptance are:

Stop No.	Limits (milliradians)
1	0 to 1
2	1 to 2
3	2 to 4
4	4 to 8

These limits were chosen to provide an adequate and roughly equal signal level for positions 2, 3, and 4. A calibrated neutral density filter in position 1 reduces the signal from the main beam to the same order of magnitude as the other signals. This reduces the dynamic range which the photometer must cover.

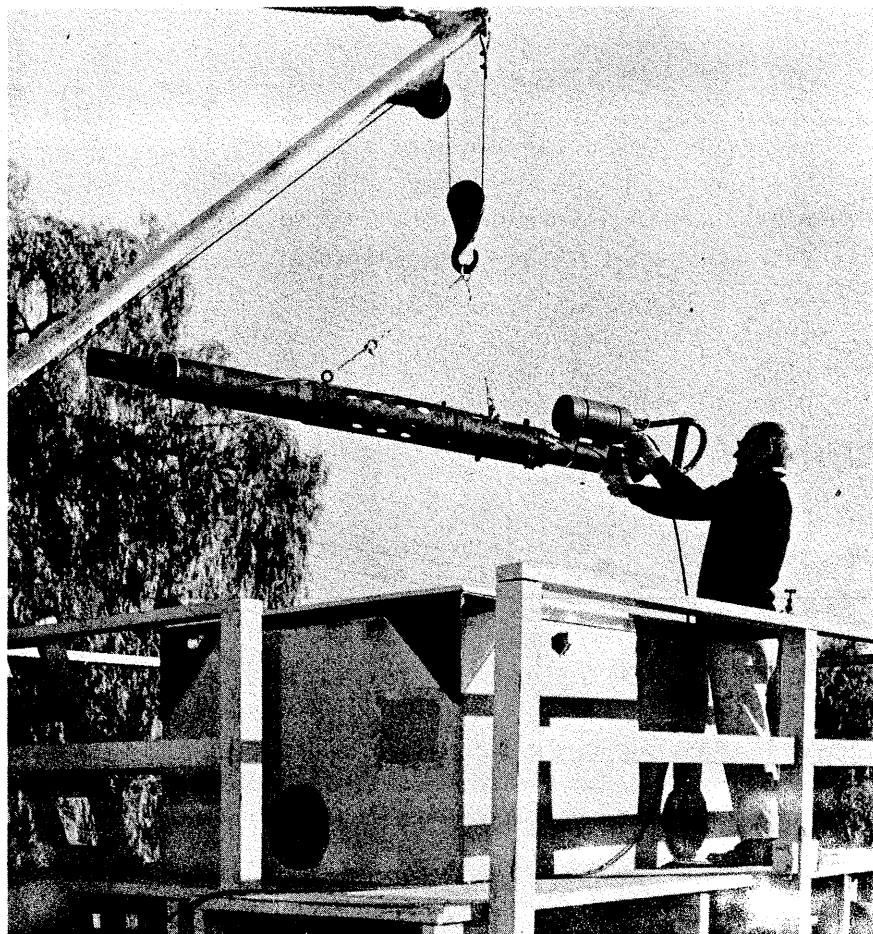
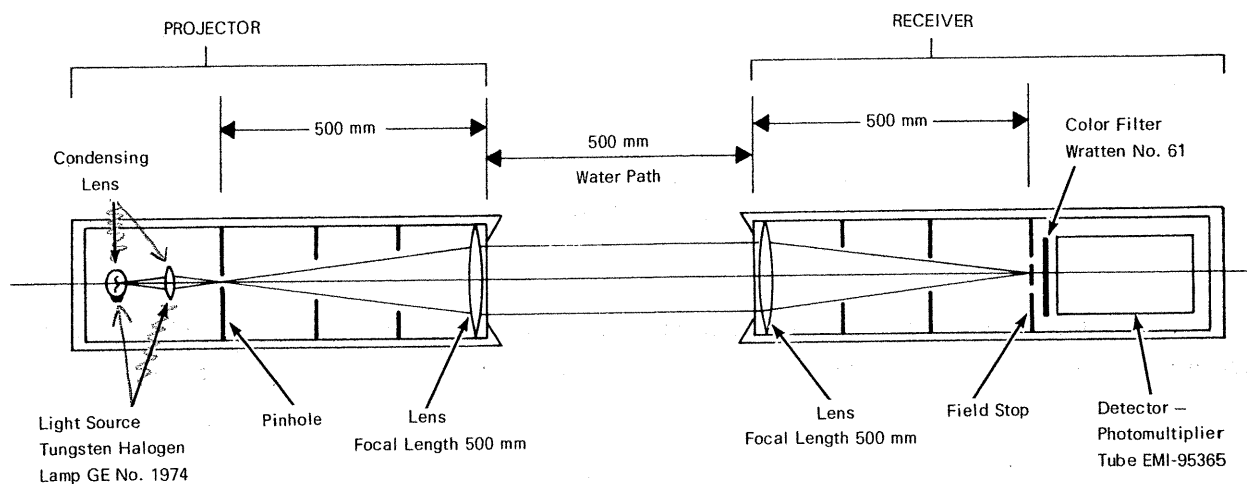

Figure 1. Low Angle Scattering Meter.



VERTICAL DIMENSIONS ARE EXAGGERATED

Figure 2. Low Angle Scattering Meter Optical Schematic.

The volume scattering function, $\sigma(\theta)$, is calculated from (see Section 3.1):

$$\sigma(\theta) = \frac{P(\theta)}{P(0)} \cdot \frac{1}{\Omega \cdot l}$$

where

$\sigma(\theta)$ = the volume scattering at angle θ

$P(0)$ = the light flux entering the sample volume and traveling in the direction $\theta = 0^\circ$

$P(\theta)$ = the light flux entering a small solid angle Ω about the angle θ at which the measurement is made

θ = the angle of scattering

Ω = the solid angle over which the measurement of $P(\theta)$ is made (steradians)

l = length of sample volume (meters).

The solid angle, Ω , is limited by the angles θ_1, θ_2 imposed by the annular field stops and is calculated, for these small angles, from $\Omega = 2\pi(\theta_2^2 - \theta_1^2)$, where θ_1 and θ_2 are in radians. The signal, v , from the photometer is linear with the light flux, P . If $v(\theta)$ is the signal obtained from $P(\theta)$, $v(0)$ is the signal obtained through a filter with transmission T_f of $P(0)$, and the sample path length is 0.500 meters, then

$$\frac{P(\theta)}{P(0)} = \frac{T_f \cdot v(\theta)}{v(0)}$$

and

$$\sigma(\theta) = 2T_f \cdot \frac{v(\theta)}{v(0)} \cdot \frac{1}{2\pi(\theta_2^2 - \theta_1^2)}$$

The overall spectral response of the instrument, including the spectral output of the light source, the spectral transmission of the filter, and the spectral response of the detector, is shown in Fig. 3.

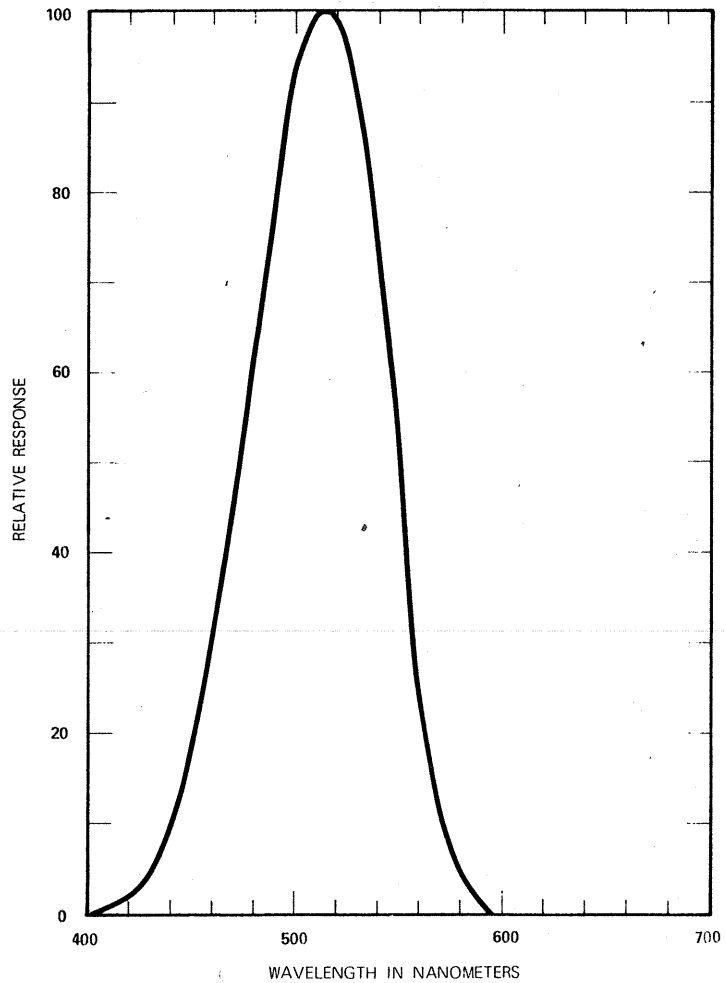

Figure 3. Spectral Response of Low Angle Scattering Meter and General Angle Scattering Meter.

2.2 GENERAL ANGLE SCATTERING METER

This instrument was developed under contract with NADC in 1969. Its purpose is to determine the volume scattering function between the limits of $\theta = 10^\circ$ in the forward direction and $\theta = 170^\circ$ in the backward direction. The instrument is illustrated in Fig. 4 and the optical system is depicted in Fig. 5. Figure 6 is a copy of a recording of the raw data for one scan and Fig. 7 is the scattering function obtained from these data.

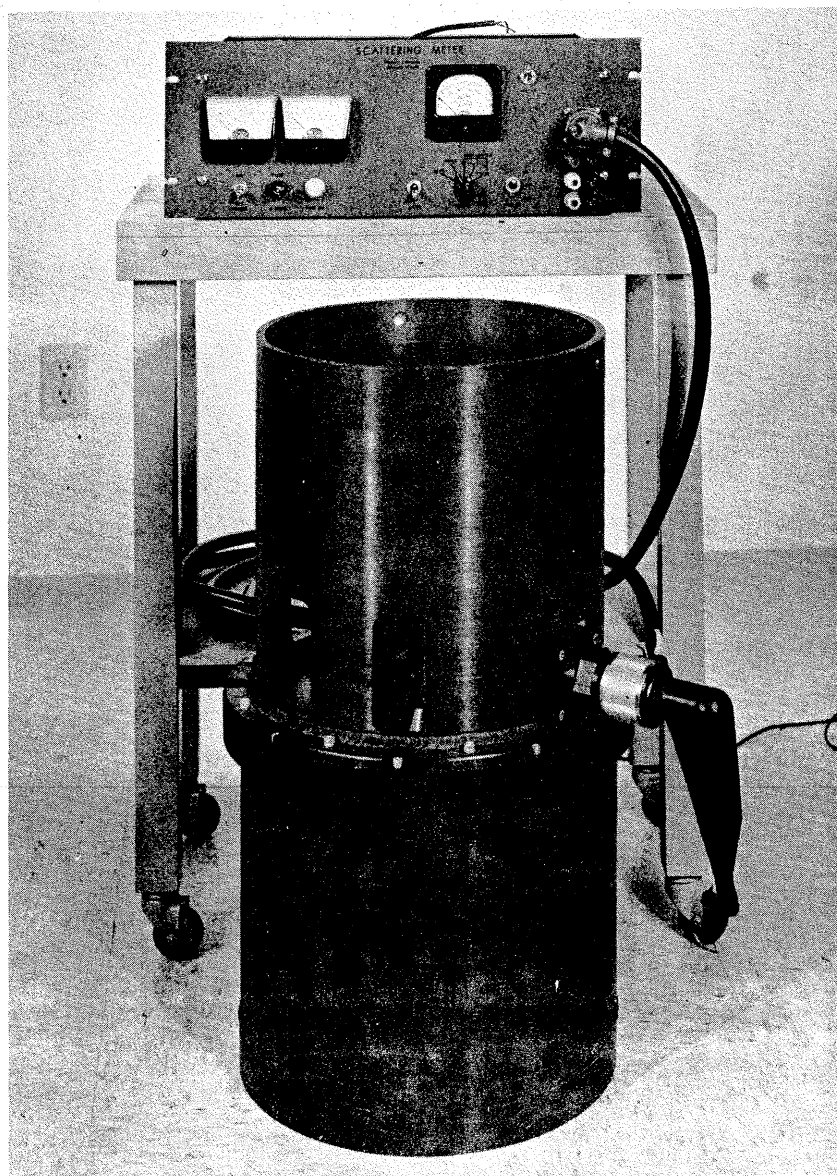

Figure 4. General Angle Scattering Meter.

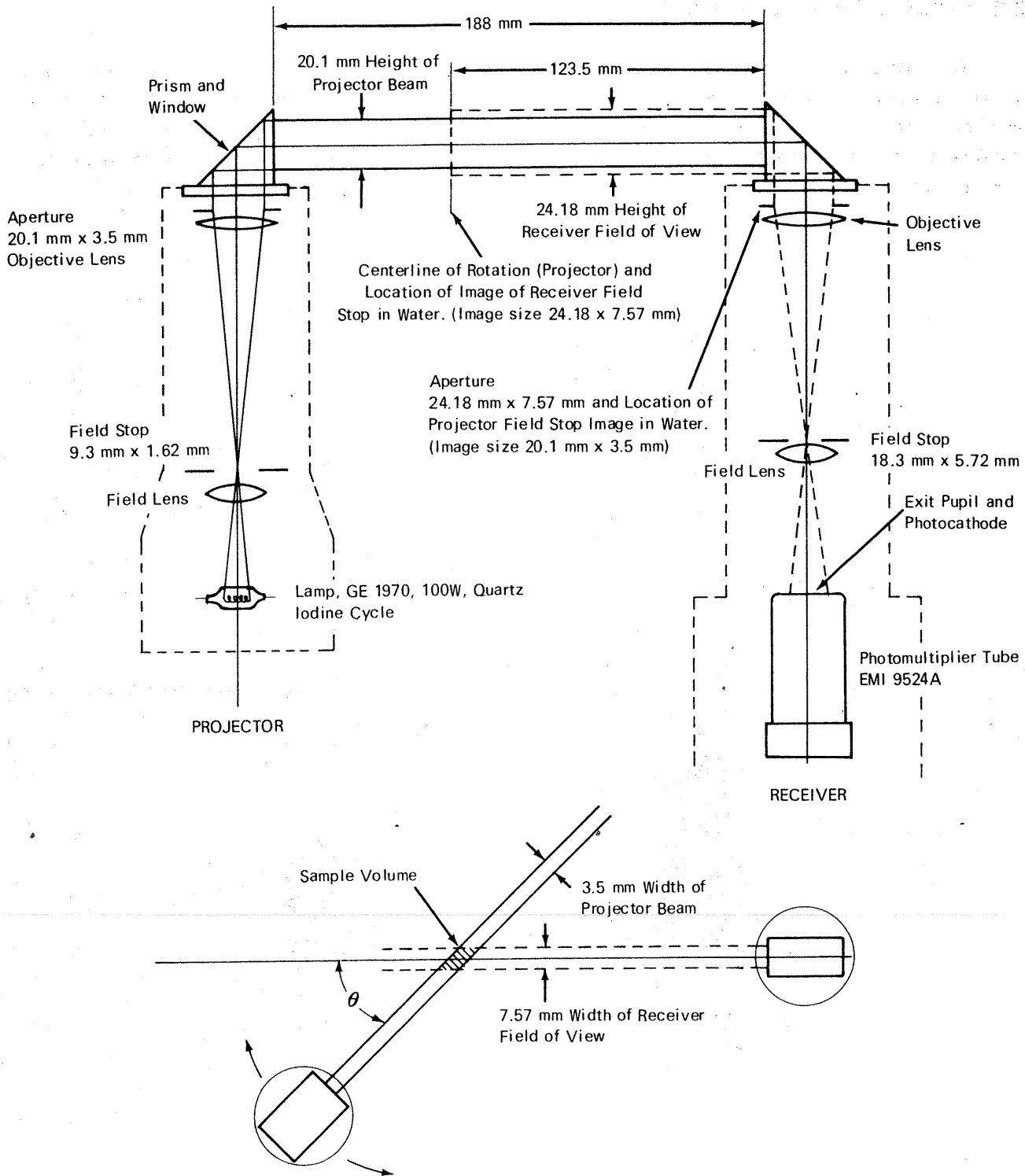

Figure 5. General Angle Scattering Meter Optical System.

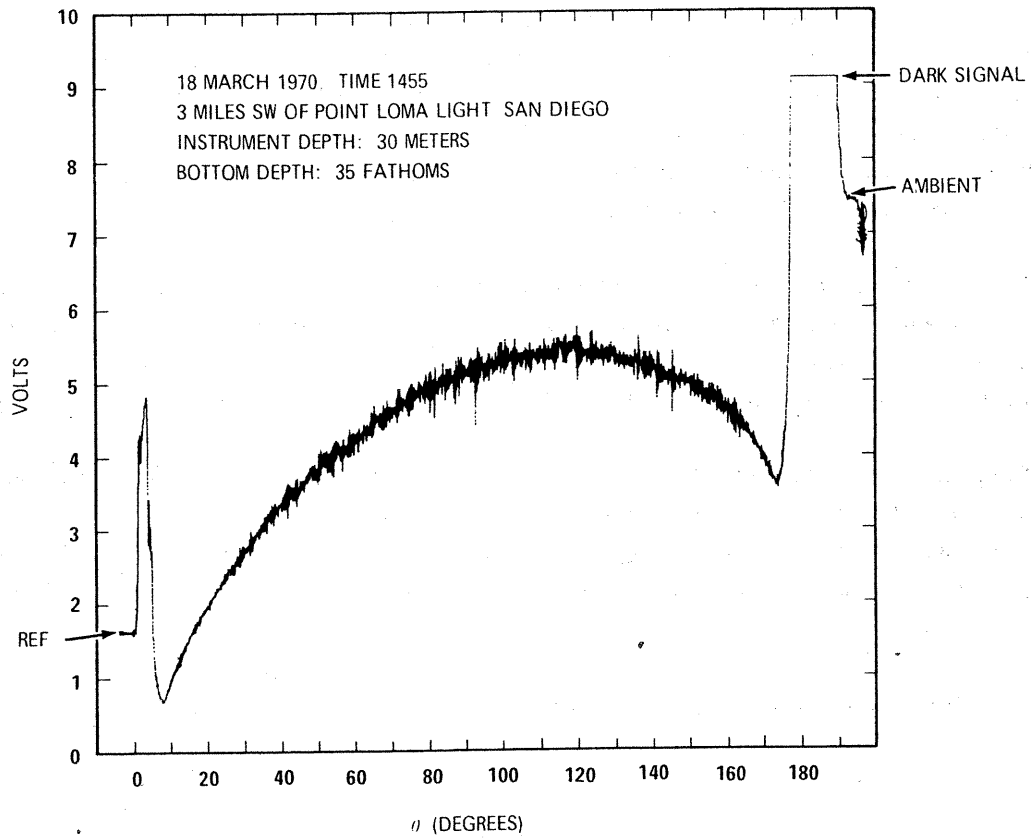

Figure 6. Sample of Signal Output Obtained with General Angle Scattering Meter.

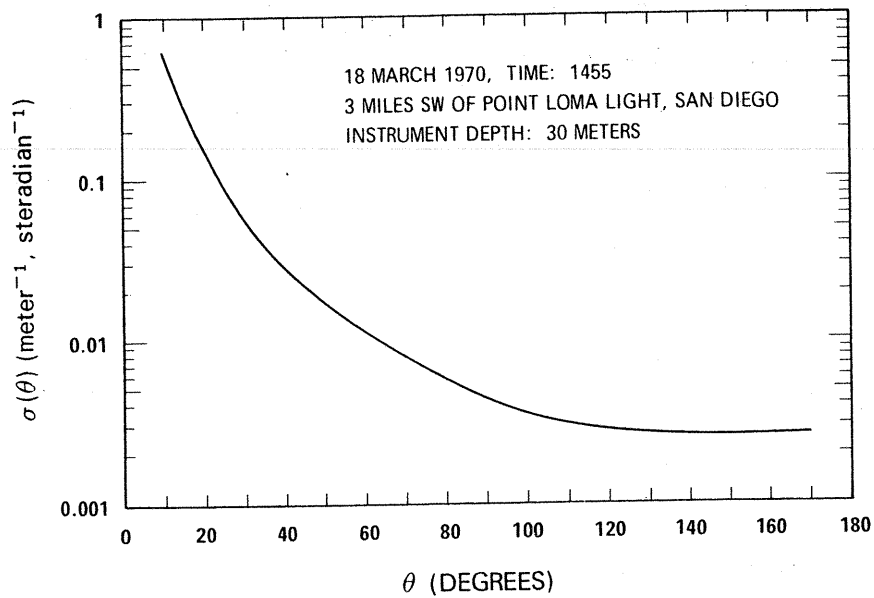

Figure 7. Sample of Final Data Obtained with General Angle Scattering Meter.

The projector rotates about the sample volume from $\theta = 0^\circ$ through $\theta = 180^\circ$. At $\theta = 0^\circ$ a measurement is made of the total power in the projected beam. Measurement of the scattered light is made, as the projector rotates, between $\theta = 10^\circ$ and $\theta = 170^\circ$, and at 180 degrees the receiver entrance is blocked and the dark signal is recorded. Just beyond 180 degrees the projector beam is blocked and a recording is made of the background ambient light level. A calibrated attenuator which lies in the main beam path at $\theta = 0^\circ$ keeps the on-axis measurement within the range of the photometer.

The instrument provides three analog voltage signals: depth, scan angle position, and photometer signal. Two methods of data collection are available. One can obtain either a continuous trace of photometer signal versus depth at any fixed angle between 10 and 170 degrees or a continuous trace of photometer signal versus scattering angle at a fixed depth. An x-y recorder is used to record the data.

The photometer spans almost six orders of magnitude with an output from 0 to 10 volts. This dynamic range is required to handle the large signal excursions encountered in this type of measurement. The photometer can be operated either in a linear or logarithmic mode. The logarithmic mode is not truly logarithmic, however, and it is necessary to use a calibration curve. No calibration curve is required when using the linear mode.

The volume scattering function in absolute units is obtained from the expression (see Section 3.1)

$$\sigma(\theta) = \frac{P(\theta)}{P(0)} \cdot \frac{1}{\Omega \cdot l},$$

where:

$P(\theta)$ = the power scattered into the solid angle Ω in the direction θ

$P(0)$ = the total power entering the sample volume

Ω = the solid angle over which $P(\theta)$ is collected and measured

l = the distance through the sample volume in the direction of $P(0)$.

The length l is determined by the width of the receiver beam and the angle θ . Introducing the constants of the system we can calculate $\sigma(\theta)$ from

$$\sigma(\theta) = C_1 \cdot T_f \cdot \frac{C_2}{T_f P(0)} \cdot \frac{P(\theta)}{C_2} \cdot F_v(\theta) \sin \theta,$$

where:

C_1 = a constant of the system geometry and includes the solid angle Ω and the length l at $\theta = 90^\circ$ ($C = 1/l \cdot \Omega = 1.76 \times 10^4 \text{ m}^{-1} \text{ sr}^{-1}$)

C_2 = a constant determined by the gain of the photometer

T_f = the transmission of the attenuator located in the beam path at $\theta = 0^\circ$ ($T_f = 5.62 \times 10^{-5}$)

$F_v(\theta)$ = a volume correction factor which allows for the slight divergence of the receiver field of view beyond the midpoint of the sample volume

$\frac{T_f P(0)}{C_2}$ = the relative value obtained from the photometer at 0°

$\frac{P(\theta)}{C_2}$ = the relative value obtained from the photometer at θ° .

The light source used is a tungsten-halogen lamp operating at a color temperature of 2900 degrees Kelvin. The detector is a photomultiplier tube with an S-11 response. The spectral response of the instrument is shown in Fig. 3.

2.3 TRANSMISSOMETER

The transmissometer, used to determine the beam transmission properties of the water, was developed at the Visibility Laboratory and has been used extensively to collect data in natural ocean waters. It measures the transmittance of a 1-meter sample path of water. Figure 8 is a photograph of this instrument.

The optics of the projection system are designed to place all of the projected light within a well-defined narrow cylindrical volume. In a similar way, the receiver optics limit the "field of view" to a cylindrical volume which contains the illuminated path. The instrument is relatively insensitive to ambient light. To shorten the instrument and allow all of the optics and underwater electronics to be located in one housing, a porro prism is used to fold the beam path.

The light source is a 20 watt tungsten-halogen lamp and the detector is a silicon photovoltaic cell operated into a low impedance circuit to obtain linearity and a low temperature coefficient. A Schott BG-18 glass filter is used to block the near infrared light and Wratten gelatin filters are used to further restrict the spectral bandwidth of the instrument. The spectral response of the instrument with five different filter combinations is shown in Fig. 9. An internal reference path enables the operator to monitor the overall system sensitivity during the data-taking process. With a sensitivity adjustment he can return the reference reading to its proper value and thus compensate for any changes in lamp output or cell sensitivity due to temperature or fatigue.

With the addition of a temperature probe and by using a winch with slings and an x, y, y^1 recorder, a continuous recording of the vertical profile of transmissivity and temperature versus depth is rapidly obtained.

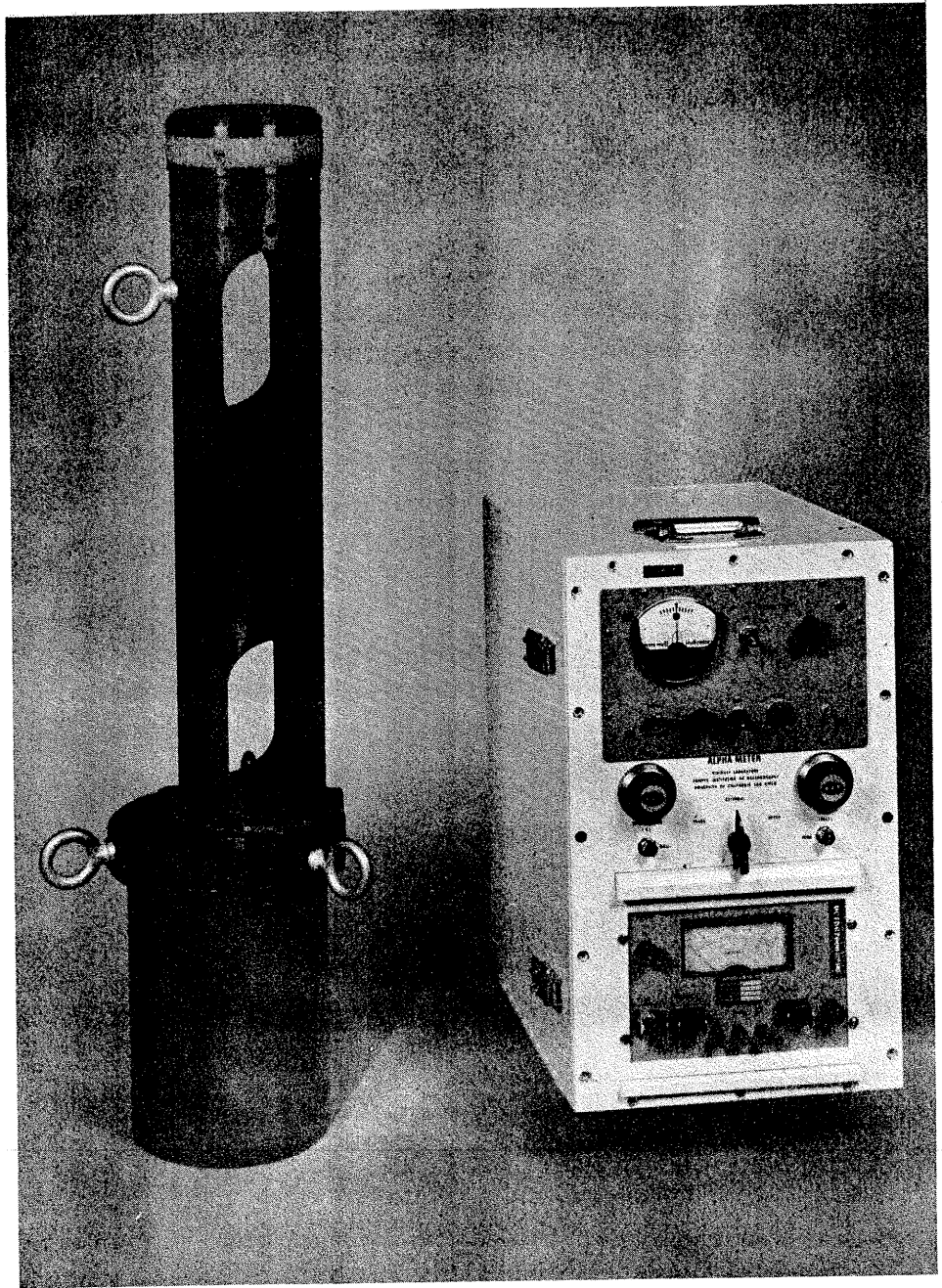

Figure 8. Beam Transmissometer.

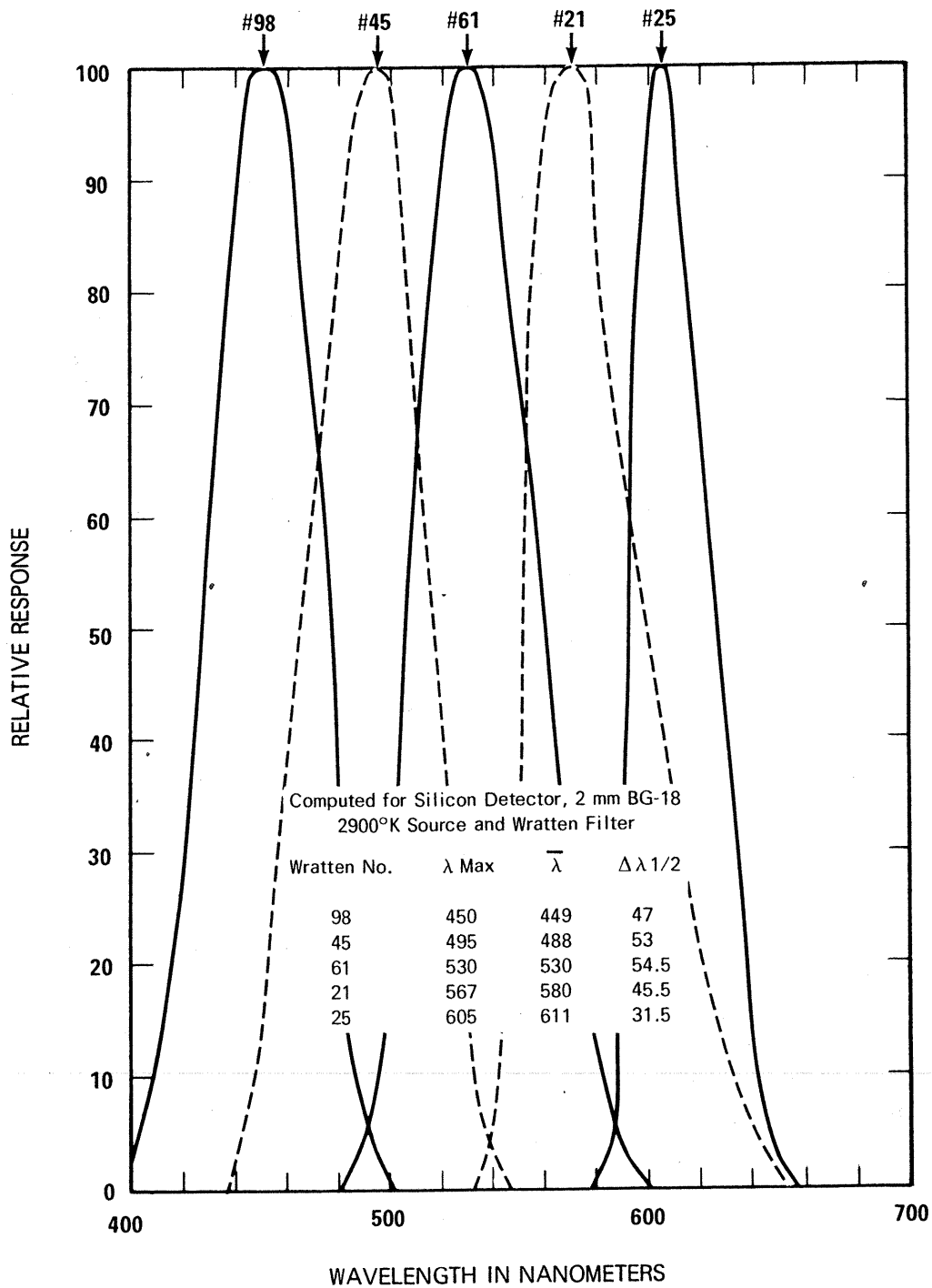

Figure 9. Spectral Response of the Beam Transmissometer.

3. CALCULATIONS

3.1 VOLUME SCATTERING FUNCTION, $\sigma(\theta)$

The scattering function $\sigma(\theta)$ is defined as

$$\sigma(\theta) = \frac{dJ(\theta)}{HdV}, \quad (1)$$

where $dJ(\theta)$ is an element of radiant intensity scattered in the direction θ , dV is an element of volume, and H is the irradiance received by the sample volume. Both the sample volume and the small solid angle, within which the radiant intensity is measured, are determined by the optical geometry of the instrument used. For an instrument which must have a finite sample volume and which collects the energy scattered at angle θ over some solid angle, Eq (1) may be rewritten as

$$\begin{aligned} \sigma(\theta) &= \frac{J(\theta)}{HV} \\ &= \frac{\frac{P(\theta)}{\Omega}}{\frac{P(0)}{A} \cdot A \cdot l} \\ \sigma(\theta) &= \frac{P(\theta)}{P(0)} \cdot \frac{1}{\Omega \cdot l}, \end{aligned} \quad (2)$$

where:

$P(\theta)$ = the power scattered into the solid angle $\Omega(\theta)$ in the direction θ

$P(0)$ = the total power entering the sample volume

V = the sample volume

Ω = the solid angle over which $P(\theta)$ is collected and measured

A = the projected area of the sample volume, V , as seen in the direction of $P(0)$

l = the distance through the sample volume in the direction of $P(0)$. (A photon has a chance of being scattered into the solid angle, Ω , while traveling this distance.)

The measurements made with the two scattering instruments allow the ratio $P(\theta)/P(0)$ to be computed. It is not necessary to know either $P(\theta)$ or $P(0)$ in absolute terms. The length, l , and the solid angle, Ω , are determined by the geometry of the instrument. The application of Eq (2) to each of the scattering meters is described in Sections 2.1 and 2.2.

3.2 VOLUME SCATTERING FUNCTION CORRECTION

The definition of the volume scattering function involves the concept of an elemental volume (see Section 3.1)

$$\sigma(\theta) = \frac{dJ(\theta)}{HdV}$$

However, in any workable instrument used to measure scattering, the sample volume will have a finite size and $\sigma(\theta)$ is obtained from the computation (see Section 3.1)

$$\sigma(\theta) = \frac{P(\theta)}{P(0)} \cdot \frac{1}{\Omega \cdot l}$$

where $P(\theta)$ is the power scattered into the solid angle Ω in the direction θ and $P(0)$ is the total power entering the volume. The scattered component $P(\theta)$ is measured leaving the sample volume; the irradiating power $P(0)$ can be determined either entering or leaving the sample volume.

We are now faced with the question of which value to use for $P(0)$ in order to calculate the value of the ratio $P(\theta)/P(0)$, used to determine $\sigma(\theta)$. Neither limiting value for $P(0)$ is correct. The desired ratio falls somewhere between these limits, and the error involved depends on the properties of the water and the sample path length used. Both of the scattering meters measure signals, from which this ratio is determined, after the light has traversed the sample path. When, by necessity, we use a sample path of

finite length, the signals measured are affected by properties of the water other than those we are attempting to measure, and we are not conforming to the definition of the property we are measuring. This error is small if the sample path length is short or the water very clear, but it can be significant when the instrument has a long path length, as is the case with the low angle scattering meter, and the water is turbid.

To analyze this problem we will make use of the terms α , a , and s , where α is the beam volume attenuation coefficient, a is the volume absorption coefficient, s is the total volume scattering coefficient, and $\alpha = a + s$. Distance also must be considered and a postscript will be used to indicate path length. The parenthetical attachment will be used to indicate angular dependence. The ratio written $P(\theta)/P(0)$ with no distance indicated will be used to represent the correct or corrected value that will give the correct result for $\sigma(\theta)$ when used in the computation

$$\sigma(\theta) = \frac{P(\theta)}{P(0)} \cdot \frac{1}{\Omega \cdot l}$$

A sample volume, with length l , is illustrated below:

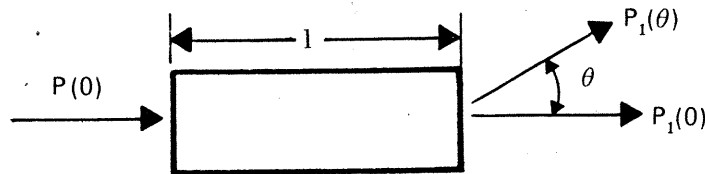

where

$P(0)$ = the light flux entering the volume

$P_1(0)$ = the flux leaving the volume and traveling undeviated from the direction of the entering flux $P(0)$ after traversing the distance l . It is the flux remaining which has been neither scattered nor absorbed:

$P_1(\theta)$ = the flux leaving the sample volume which has been scattered into a small solid angle Ω in a direction θ with respect to the entering flux $P(0)$.

The relative values for $P(0)$, $P_1(\theta)$, and $P_1(0)$ are measurable quantities. The component $P_1(\theta)$ has been attenuated while traveling the distance, l , and therefore the ratio $P_1(\theta)/P(0)$ is too small. The component $P_1(0)$ has also been attenuated while traveling the distance, l , but part of this loss is due to scattering. A proportionate part of this scattered light is contributed to $P_1(\theta)$ and it seems that the ratio $P_1(\theta)/P_1(0)$ will be too large and the desired ratio $P(\theta)/P(0)$ will fall between these limits:

$$\frac{P_1(\theta)}{P(0)} < \frac{P(\theta)}{P(0)} < \frac{P_1(\theta)}{P_1(0)}$$

The desired ratio, $P(\theta)/P(0)$, is that which makes $P(\theta)/P(0) \cdot 1/l$ equal to the limit that $P_1(\theta)/P(0) \cdot 1/l$ would approach as the sample path length is decreased to zero. The $P(0)$ is constant and we can write

$$\frac{P(\theta)}{l} = \lim_{l \rightarrow 0} \frac{P_1(\theta)}{l},$$

where $P_1(\theta)$ is the power leaving the sample volume of length, l , and entering the solid angle, Ω , in the direction θ . The limit $P(\theta)/l$ is the power which would be scattered in the direction θ within the solid angle Ω as a result of $P(0)$ traversing a unit length of water if no absorption occurred. To account for this absorption, we can use the volume absorption coefficient, a , and write

$$P(\theta) e^{-a l} = P_1(\theta). \quad (3)$$

The light leaving the volume, $P_1(0)$, is that remaining portion of $P(0)$ which has been neither scattered nor absorbed. The total volume attenuation coefficient, α , relates these two:

$$P(0) e^{-\alpha l} = P_1(0). \quad (4)$$

Dividing Eq (3) by Eq (4) gives

$$\frac{P(\theta) e^{-a l}}{P(0) e^{-\alpha l}} = \frac{P_1(\theta)}{P_1(0)}$$

$$\frac{P(\theta)}{P(0)} = \frac{e^{-a l} P_1(\theta)}{e^{-\alpha l} P_1(0)}$$

$$= e^{-(\alpha - a) l} \cdot \frac{P_1(\theta)}{P_1(0)}$$

$$\frac{P(\theta)}{P(0)} = e^{-s l} \cdot \frac{P_1(\theta)}{P_1(0)}. \quad (5)$$

If $P(0)$ were the measured quantity instead of $P_1(0)$, the applicable form would be:

$$\frac{P(\theta)}{P(0)} = \frac{1}{e^{-a l}} \cdot \frac{P_1(\theta)}{P(0)}. \quad (6)$$

When a scattering measurement is made using a finite volume of water, an unavoidable error is caused by absorption in the sample volume. If the instrument used has a sample path length that is small relative to the attenuation length, $(1/a)$, of the water, this error is small and is probably less than the instrumental errors and time-varying fluctuations. If the measurement is made using a path length that is not small relative to the attenuation length, the results can be corrected by applying the factors indicated in Eq (5) or (6). If the measured data is used to determine the total scattering coefficient, s , then it is necessary to use an iterative process which will produce an s value that agrees with the s value used in determining the correction factor.

The statement that the $P_1(\theta)$ signal is attenuated by absorption and by an amount equal to e^{-a^1} may not be strictly true. Where the path length is about one attenuation length or more, multiple scattering effects may also affect $P_1(\theta)$. If this is the case, the correction factor (for Eq (5)) would lie somewhere between e^{-s^1} and e^{-a^1} . For the most turbid water investigated, i.e., $a = 2.19$, $s = 1.928$, and $a = 0.262$, the path length of the low angle scattering meter (0.5 meters) is very nearly equal to one attenuation length. In this case, e^{-a^1} is within 14 percent of e^{-s^1} and the error would be less than this. It should be noted that this applies only to the three points obtained with this instrument and that the affect on the computed total scattering coefficient is negligible.

3.3 COMPUTATION OF THE TOTAL VOLUME SCATTERING COEFFICIENT, s

It can be shown, that $s = 2\pi \int_0^\pi \sigma(\theta) \cdot \sin \theta \cdot d\theta^*$, where $\sigma(\theta)$ is the volume scattering function at angle θ , and θ is the scattering angle measured from the forward direction of the incident light.

This integration was performed by computer using a parabolic fit between data points. To bridge the gap between the 10-degree data point (lowest angle obtainable from the general angle scattering meter) and the 0.338-degree point (highest angle from the low angle scattering meter), one to three values which fell on a smooth curve between these points were hand-computed and used as inputs to assist in the curve fitting. For computer processing, the form of the integral was changed as follows:

$$\Delta s = 2\pi \int_{\theta_1}^{\theta_2} \sigma(\theta) \cdot \sin \theta \cdot d\theta$$

$$d(\text{Log}_{10}\theta) = \frac{1}{\theta} (\text{Log}_{10}e) d\theta$$

$$d\theta = \theta (\text{Log}_e 10) d(\text{Log}_{10}\theta)$$

$$\Delta s = 2\pi (\text{Log}_e 10) \int_{\theta_1}^{\theta_2} \sigma(\theta) \cdot \sin \theta \cdot \theta \cdot d(\text{Log}_{10}\theta).$$

*J. E. Tyler and R. W. Preisendorfer, *The Sea* (Interscience Publishers, John Wiley and Sons, New York, New York, 1962), Vol I.

This allows the use of logarithmic increments in the integration for the low angles. The integration was performed using the following increments over the angular ranges indicated. (From 0 to 0.1 degrees the function was assumed to follow the form $\log \sigma(\theta) = m \log \theta + \log C$. The constants were determined from the data for the two lowest angles obtained with the low angle meter.)

Angular Range (degrees)	Increment	No. of Steps
0.1 to 10	$d(\log_{10}\theta) = 0.01$	200
10 to 180	1°	170

The e^{-s_1} correction discussed in Section 3.2 was applied to all computations through an iterative computer program which assumes an s value for the e^{-s_1} correction and applies this correction to all $\sigma(\theta)$ values. The assumed s was then compared with the computed s . If they differed by more than 0.1 percent, the process was repeated, with the new assumed s being the prior computed s . This was continued until an agreement of 0.1 percent or better was reached.

3.4 DETERMINATION OF THE ANGLE θ FOR THE LOW ANGLE SCATTERING METER DATA

The value computed for the volume scattering function $\sigma(\theta)$ is an average value for $\sigma(\theta)$ between the angular limits, θ_1 and θ_2 , of the solid angle, $\Omega(\theta)$, over which the measurement was made. Some angle, θ , between θ_1 and θ_2 exists for which $\sigma(\theta)$ equals the average $\sigma(\theta)$ computed. For a linear function this would be the midpoint. For small angles the $\sigma(\theta)$ function is a rapidly rising exponential function as θ decreases; and the correct angle to assign to the $\sigma(\theta)$ computed may not be the midpoint of the measurement limits.

Over the range covered by the low angle scattering meter, the $\sigma(\theta)$ function is of the form $\sigma(\theta) = C\theta^m$. This function is sketched below.

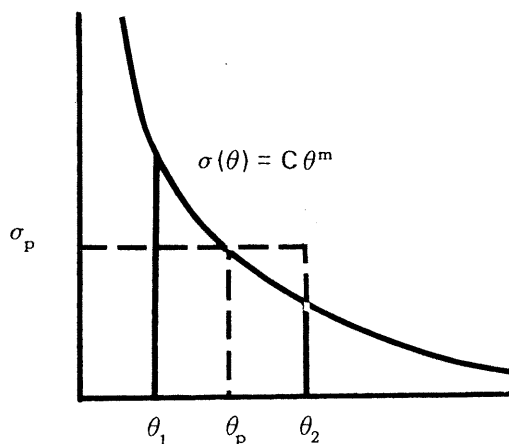

σ_p is the computed average value.

θ_p is the angle at which $\sigma(\theta) = \sigma_p$.

θ_2 is the upper angular limit of the measurement from which θ_p was computed.

θ_1 is the lower limit.

The σ_p is determined over the solid angle $\pi(\theta_2^2 - \theta_1^2)$. This average value, σ_p , times this solid angle equals the portion of the total scattering function, s , which lies within these same limits, so that

$$\sigma_p \cdot \pi(\theta_2^2 - \theta_1^2) = 2\pi \int_{\theta_1}^{\theta_2} \sigma(\theta) \cdot \sin \theta \cdot d\theta.$$

Substituting $C\theta^m$ for $\sigma(\theta)$ and θ for $\sin \theta$, both valid for the small angles and increments involved, we obtain

$$\sigma_p \cdot \pi(\theta_2^2 - \theta_1^2) = 2\pi C \int_{\theta_1}^{\theta_2} \theta^m \cdot \theta \cdot d\theta$$

$$= 2\pi C \int_{\theta_1}^{\theta_2} \theta^{m+1} \cdot d\theta$$

$$= \frac{2\pi C}{m+2} \left[\theta^{m+2} \right]_{\theta_1}^{\theta_2}$$

$$= \frac{2\pi C}{m+2} (\theta_2^{m+2} - \theta_1^{m+2})$$

$$\sigma_p = \frac{2C}{m+2} \cdot \frac{(\theta_2^{m+2} - \theta_1^{m+2})}{(\theta_2^2 - \theta_1^2)}$$

Now if

$$\sigma(\theta) = C\theta^m,$$

then

$$\theta_p = \left(\frac{\sigma_p}{C} \right)^{1/m}$$

and

$$\theta_p = \left[\frac{2(\theta_2^{m+2} - \theta_1^{m+2})}{(m+2)(\theta_2^2 - \theta_1^2)} \right]^{1/m}$$

where θ_p is the angle at which $\sigma(\theta)$ equals our measured σ_p . For the special case of $m = -2$, this form is indeterminate. When $m = -2$, the integral becomes

$$\begin{aligned} \int_{\theta_1}^{\theta_2} \theta^{m+1} \cdot d\theta &= \int_{\theta_1}^{\theta_2} \frac{d\theta}{\theta} \\ &= \left[\ln \theta \right]_{\theta_1}^{\theta_2} \\ &= (\ln \theta_2 - \ln \theta_1) . \end{aligned}$$

Using this form and following the same steps as before produces

$$\theta_p = \left[\frac{2(\ln \theta_2 - \ln \theta_1)}{\theta_2^2 - \theta_1^2} \right]^{-1/2}$$

for the special case when $m = -2$.

When $m = 0$, $\sigma(\theta)$ is a constant value for all angles and θ_p is not definable, but as m becomes very small and approaches zero, θ_p approaches the midpoint:

$$\theta_p = 1/2 (\theta_2 + \theta_1) .$$

The exponent m is the slope of $\log \sigma(\theta)$ versus $\log \theta$ and, for the waters studied, lies between $m = 0$ and $m = -2$. Below is a tabulation of θ_p values for the limits θ_1 and θ_2 (imposed by the optics of the instrument) calculated for $m = -2$ and $m = 0$ and the θ_p values used in processing the data.

$\theta_1 - \theta_2$ (radians)	θ_p (m = -2)	θ_p (m = 0)	θ_p (Data Processing)
0.001 to 0.002	0.00147	0.0015	0.00149
0.002 to 0.004	0.00294	0.0030	0.00295
0.004 to 0.008	0.00588	0.0060	0.00590

For this type of instrument the change in solid angle with angle θ very nearly compensates for the change in volume scattering function, $\sigma(\theta)$. And the $\sigma(\theta)$ value calculated is the value for an angle, θ , only slightly different from the midpoint between the limits, θ_1 and θ_2 , over which the measurement was made.

4. VALIDATION EXPERIMENT

This experiment was designed to demonstrate if the two instruments used for the *in situ* scattering measurements do in fact respond to the scattering properties of the water and if they are, as they should be, insensitive to the absorption properties of the water.

The volume attenuation coefficient, α , is the sum of the total volume scattering coefficient, s , and the absorption coefficient, a . The volume attenuation coefficient, α , is easily determined with a beam transmissometer from $T = e^{-\alpha l}$. The scattering meters provide data from which the volume scattering function $\sigma(\theta)$ is obtained and from which the total scattering coefficient, s , is calculated by performing the summation indicated by $s = 2\pi \int_0^\pi \sigma(\theta) \cdot \sin \theta \cdot d\theta$. (See Section 3.3.) Since $\alpha = s + a$, any increase in scattering would cause an increase in s , Δs , and an equal increase in α , $\Delta \alpha$. Similarly, an increase in absorption would cause an increase in a , Δa , and an equal increase in α , $\Delta \alpha$, but no change in s .

In this experiment scattering material was introduced into clear water and the resultant change in α , as determined with a beam transmissometer, was compared with the change in s , as determined from measurements with the scattering instruments. Ideally, the increments would be equal. Then, an absorbing material was added and again the resulting changes in the measured values of α and s were compared. Ideally, in this case, the scattering meters would indicate no increase in s although the transmissometer would show an increase in α .

A test tank at the Visibility Laboratory was filled with fresh water which was pumped through a filter containing diatomaceous earth. The filtering was stopped and during the rest of the experiment the water was kept agitated and thoroughly mixed by a constantly running large diameter mixing propeller. The three instruments described in Section 2 were placed in the water and data recorded for three types of water: (1) clear filtered water, (2) clear water with artificially introduced scattering properties, and (3) water No. 2 with the addition of artificially introduced absorption properties.

Aluminum hydroxide and magnesium hydroxide are compounds which principally cause scattering when dispersed in water. A mixture of these two compounds was used for the scattering agent. The black organic dye Nigrosin was used to increase the absorption. When the scattering agent is added, the change in s , Δs , should ideally equal the change in α , $\Delta \alpha$. Similarly, an addition of the absorbing dye causes an increase in a but ideally should have no effect on s .

At the start of the test the beam transmissometer measurement indicated $\alpha = 0.102\text{m}^{-1}$ and the total s computed from the measurements made with the two scattering meters was $s = 0.009\text{m}^{-1}$, which would make $a = 0.093\text{m}^{-1}$. After adding enough scattering material to produce a significant change in the beam transmission (from 90.2 percent per meter to 50.4 percent per meter) and allowing time for the water to become thoroughly mixed, the measurements were repeated. From the beam transmissometer and from the scattering meters, $\alpha = 0.685\text{m}^{-1}$ and $s = 0.544\text{m}^{-1}$ were obtained. The addition of a material which is largely scattering in nature produced a change in α of $\Delta\alpha = 0.583\text{m}^{-1}$ and a change in s of $\Delta s = 0.535\text{m}^{-1}$. The change in the volume scattering coefficient calculated from the two sets of measurements with the two scattering meters was 91.8 percent of the change in the volume attenuation coefficient! These results would indicate that the volume absorption coefficient was changed by $\Delta a = 0.048\text{m}^{-1}$, which is 8.2 percent of the change in α and 9.0 percent of the calculated change in s .

To determine how sensitive the scattering meters were to absorption, the black dye was added to the water again in a large enough amount to produce a significant change in the beam transmission (from 50.4 percent per meter to 27.3 percent per meter). A third set of measurements gave $\alpha = 1.340\text{m}^{-1}$ and s was calculated to be 0.573m^{-1} . This time, the addition of an absorbing dye caused a change in the volume attenuation coefficient of $\Delta\alpha = 0.655\text{m}^{-1}$ and a change in the calculated volume scattering coefficient of $\Delta s = 0.029\text{m}^{-1}$. This change in s is only 4.4 percent of the change in α . The corresponding change in the volume absorption coefficient would be $\Delta a = 0.626\text{m}^{-1}$ or 96.6 percent of the change in α .

The volume scattering functions for the three waters are shown in Fig. 14. The computed α , a , and s values are tabulated below. The absorption coefficient, a , was obtained by subtraction: $a = \alpha - s$.

Water Type	α	s	a	$\Delta\alpha$	Δs	Δa	$\frac{\Delta s}{\Delta\alpha}$	$\frac{\Delta a}{\Delta\alpha}$
Filtered water	0.102	0.009	0.093					
Water with scattering agent added	0.685	0.544	0.141	0.583	0.535	0.048	0.918	0.082
Water with absorbing agent added	1.340	0.573	0.767	0.655	0.029	0.626	0.044	0.956

The water was not absolutely stable during the time of the test. Constant monitoring with the beam transmissometer showed a very slow drift in the direction of increasing α . This could account for the small increase in absorption, $\Delta a / \Delta\alpha \times 100 = 8.2$ percent, when the scattering agent was added, as well as the even smaller increase in scattering, $\Delta s / \Delta\alpha \times 100 = 4.4$ percent, when the dye was added. It also is likely that the scattering material used was not ideal and did absorb light to a small extent, which is reflected in the measurements. An earlier test similar to this one, for which the changes in scattering and absorption were much smaller, gave even better, although nearly identical, results.

The scattering meters can detect a difference in scattering of less than 2 percent, but in the data which had noise related to the water scattering and the sample volume size, the precision was degraded

to probably no better than ± 5 percent under the conditions of this test. Considering that two sets of measurements were used for each determination of Δa , Δs , and Δa , the results are unexpectedly good.

Adding a quantity of material to the water which is highly scattering and low in absorption allowed the change in the volume scattering coefficient to be determined with a beam transmissometer. Assuming no change in absorption, the change in a as determined with the beam transmissometer was equal to the change in the volume scattering coefficient. Thus the performance of the scattering meters was tested by comparison with a simple measurement taken with an instrument of proven reliability. The beam transmissometer was also used to give a measure of the change in a when a large amount of absorbing black dye was added to the water to evaluate the insensitivity of the scattering meters to absorption.

This entire test was performed to determine the validity of the *in situ* measurements obtained with the scattering meters and the computation of the total volume scattering coefficient from these measurements. The results indicate that: (1) the instruments are capable of providing accurate data on the scattering properties of the water, (2) the total volume scattering coefficient, s , can be computed from these data, and (3) the scattering instruments are relatively insensitive to absorption.

5. DESCRIPTION OF DATA PRESENTATION AND COMMENTS

5.1 VOLUME SCATTERING FUNCTION CURVES

Figures 10 through 15 show the volume scattering function, $\sigma(\theta)$, versus angle, θ , for natural ocean waters and for fresh water that has been filtered and artificially modified. The $\sigma(\theta)$ function is in absolute units (meter^{-1} , steradian^{-1}). The symbols on the curves mark the data points used. One data point at 0.0859 degrees (0.00149 radians) falls below the 0.1-degree edge of the format and is not shown. For the clear waters, the signal level for this point was too low to be usable. However, this point was used for the more turbid waters.

Figure 10 is a composite of selected curves for greatly different types of natural ocean waters.

Figure 14 shows the curves from the evaluation test on the scattering meters described in Section 4. Notice that the addition of absorbing material to the water caused very little change in the scattering function, showing that the instruments are insensitive to absorption.

Figure 15 illustrates curves obtained from sea water that was pumped from outside the breaker line and brought by tank truck to the laboratory. The curves are for the water as delivered and after several steps of filtration. Notice the loss of low angle forward scattering after 18 hours of filtering. The scattering signal at 0.00149 radians and 0.00295 radians was too low to be measurable.

5.2 PROBABILITY CURVES

The curves in Fig. 16 through 21 show graphically the function which is the ratio

$$P = \frac{2\pi \int_0^\theta \sigma(\theta) \cdot \sin \theta \cdot d\theta}{2\pi \int_0^\pi \sigma(\theta) \cdot \sin \theta \cdot d\theta} = \frac{2\pi \int_0^\theta \sigma(\theta) \cdot \sin \theta \cdot d\theta}{s}$$

The integral $2\pi \int_0^\theta \sigma(\theta) \cdot \sin \theta \cdot d\theta$ is that portion of the total scattering coefficient which lies between zero and the angle θ . These ratios represent the ratio of the power scattered into angles less than θ relative to the total scattered power only for short path lengths, l , where $s \cdot l \ll 1$ and the approximation $1 - e^{-s \cdot l} = s \cdot l$ is valid.

5.3 SCATTERING DATA TABULATION

Figures 22 through 51 show a listing of the values entered into the computer program and the corresponding $\sigma(\theta)$ values after the iteration process to make the $e^{-s \cdot l}$ correction. (See Section 3.2.) Also listed are the total volume attenuation coefficient, α , at wavelength $\lambda = 530 \text{ nm}$ and the calculated values for the total scattering coefficient, s , the absorption coefficient, a , and the ratios s/α , a/α , and B/S .

The ratio B/S is calculated from:

$$B/S = \frac{2\pi \int_{90^\circ}^{180^\circ} \sigma(\theta) \cdot \sin \theta \cdot d\theta}{s}$$

It is the ratio that shows what portion of the scattering coefficient occurs in the backward direction between 90 and 180 degrees.

The slope, m , is the log-log slope where

$$\log \sigma(\theta) = m \log \theta + \log C.$$

The slope m is determined from the last two data points from the low angle meter and the constant $\log C$ is found from the intercept of the line through these points at the $\theta = 1^\circ$ ordinate. The logarithmic function is used to extrapolate to $\theta = 0^\circ$ and to compute that part of the integral from 0 to 0.1 degrees:

$$2\pi \int_0^{0.1^\circ} \sigma(\theta) \cdot \sin \theta \cdot d\theta .$$

Also shown are the ratios $\sigma(\theta)/s$ for $\theta = 20, 40, 45,$ and 90 degrees and the median angle where the probability function is one-half.

Following this tabulation is a listing of $\sigma(\theta)$ values, the integral $2\pi \int_0^\theta \sigma(\theta) \cdot \sin \theta \cdot d\theta$, and this integral divided by the total scattering coefficient s (normalized integral). The computer program computed 371 points. To reduce the volume, a sampling of 55 of these points is given for increments of angle $\Delta \log \theta = 0.1$ from $\theta = 0.1^\circ$ to $\theta = 10^\circ$ and increments of $\Delta \theta = 5^\circ$ from $\theta = 10^\circ$ to $\theta = 180^\circ$.

6. DATA PRESENTATION

Data on the scattering properties of three very different types of ocean water are presented in the form of curves and tabulations (Fig. 10 through 51) in this section. The measurements were taken with the instruments described in Section 2. The calculations involved are discussed in Section 3, and a detailed description of the data presentation is given in Section 5. The meter is used throughout this section for the unit of length. In the computer-printed tabulation, the volume attenuation coefficient, α , the volume scattering coefficient, s , and the volume absorption coefficient, a , all have the unit meter^{-1} .

Data from four locales are presented: (1) the "Tongue of the Ocean," Bahama Islands, (2) offshore southern California, (3) San Diego Harbor, California, and (4) a laboratory test tank at the Visibility Laboratory, San Diego, California. The data for the Tongue of the Ocean, Bahama Islands, are labeled "AUTEK-TEST-161." The locations and bottom depths for the three stations for which data are given are shown below.

Station No.	Latitude	Longitude	Depth
7	24°30' 31" N	77°41' 40" W	7 fathoms
8	24°29' N (Approx)	77°33' W (Approx)	850 to 870 fathoms
9	24°38' N (Approx)	77°37' W (Approx)	1045 fathoms

The data for offshore southern California are labeled HAOCE. Station No. 5 was in Avalon Cove, Catalina Island, at latitude 33°20.8' N and longitude 118°19.2' W and Station No. 11 was in the channel between Catalina Island and the California coast at latitude 33°30.0' N and longitude 118°23' W. The data taken in San Diego Harbor are designated NUC and the work conducted at the Visibility Laboratory is labeled VISLAB.

VOLUME SCATTERING FUNCTION

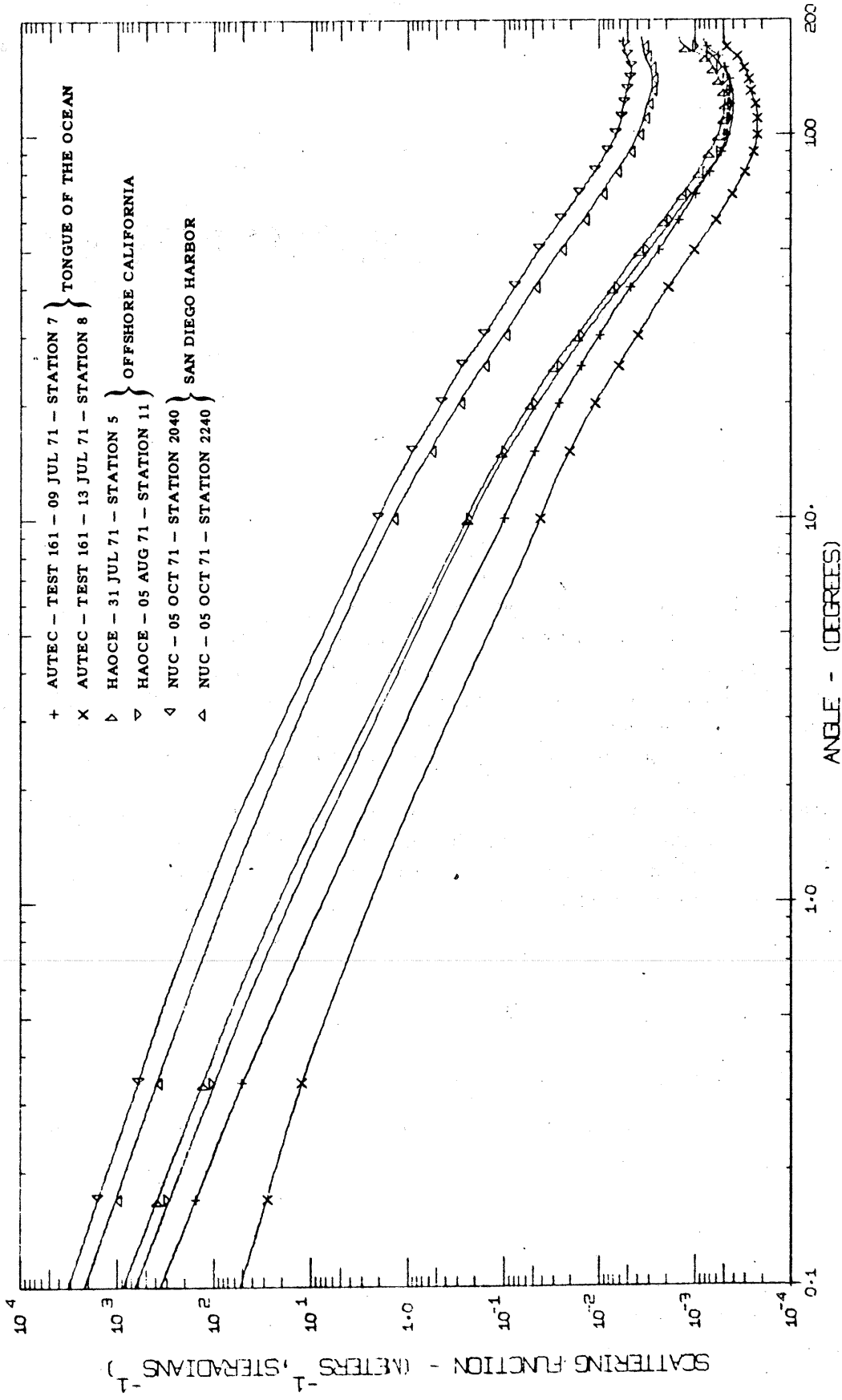

Figure 10

VOLUME SCATTERING FUNCTION

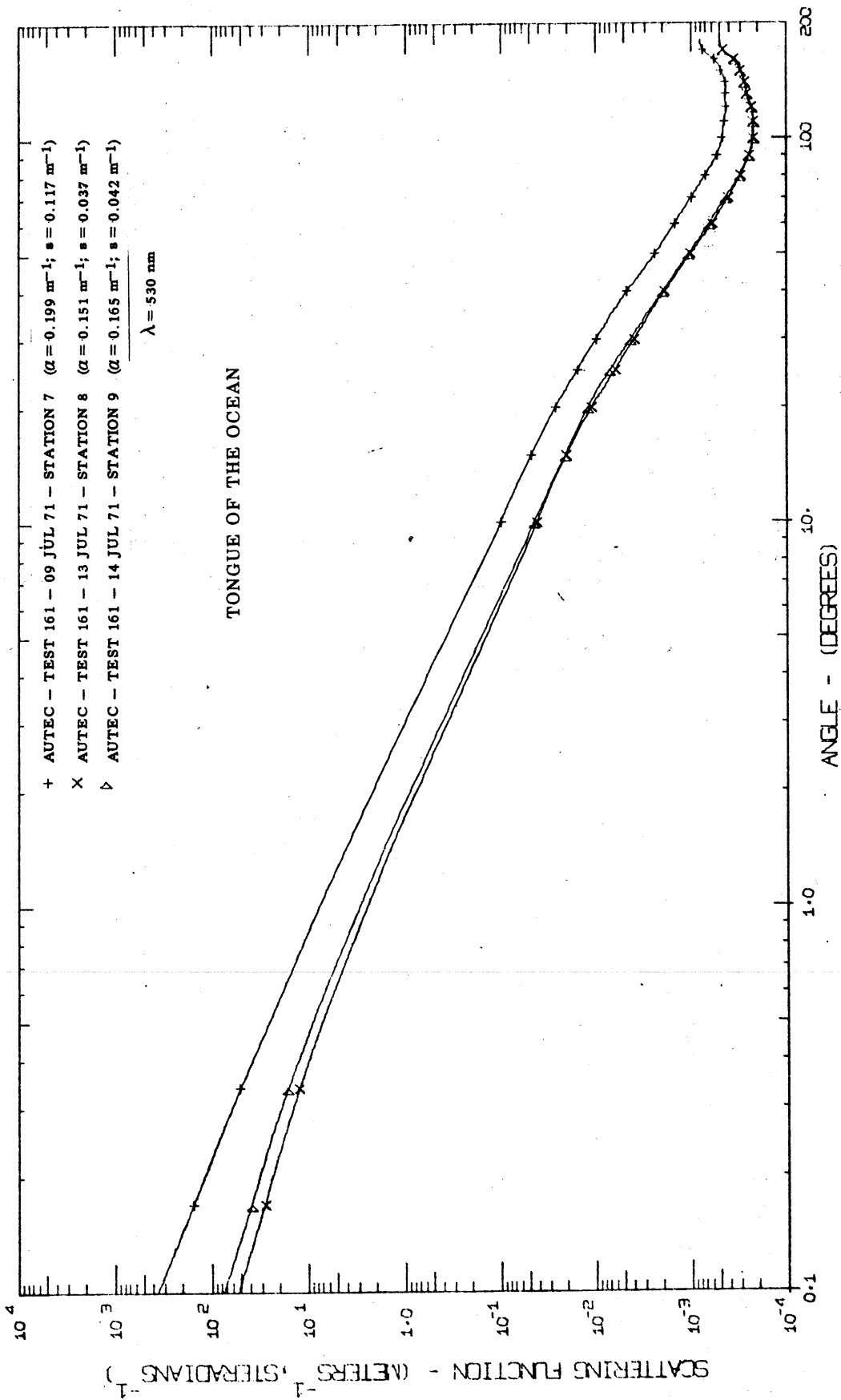

Figure 11

VOLUME SCATTERING FUNCTION

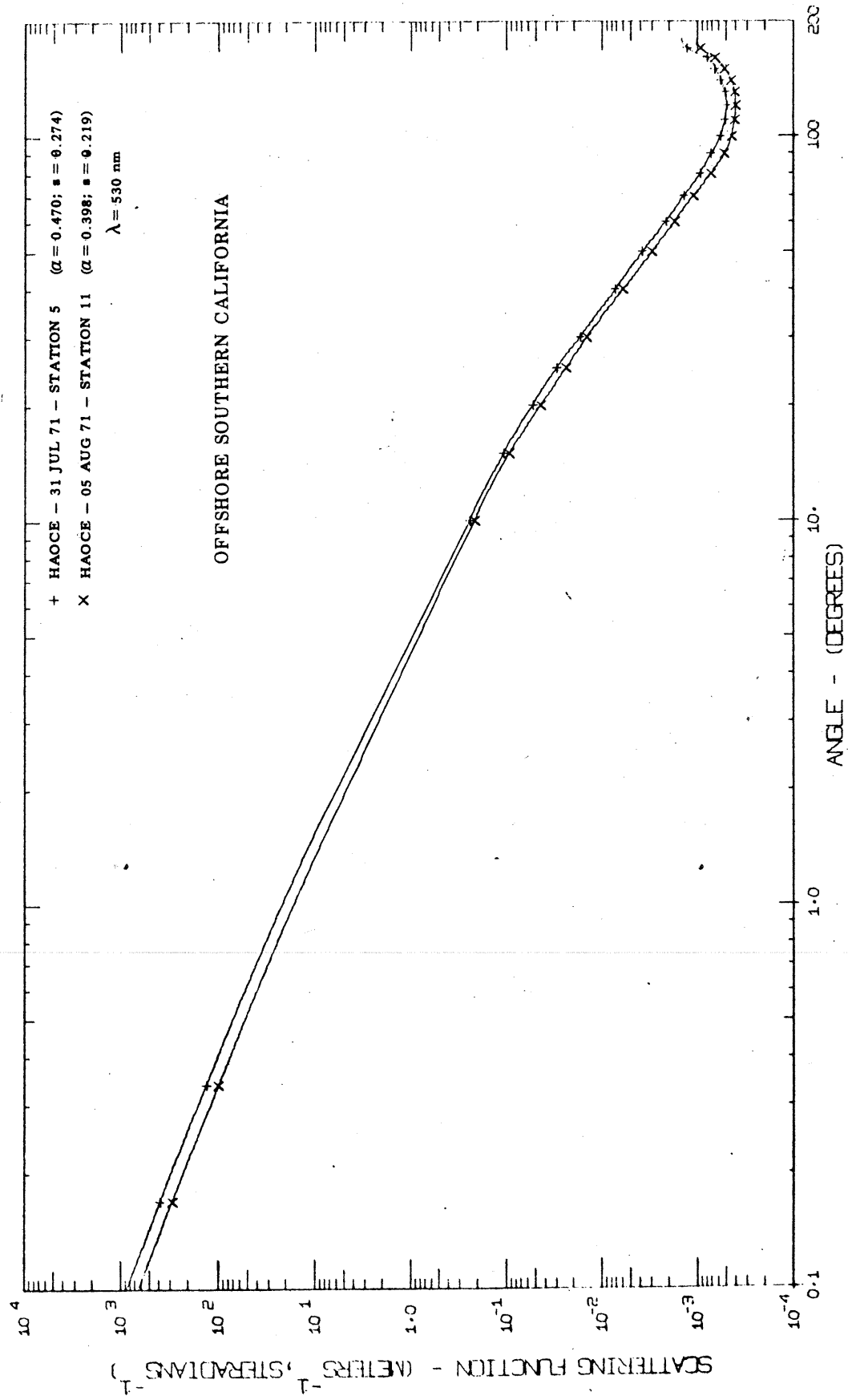

Figure 12

VOLUME SCATTERING FUNCTION

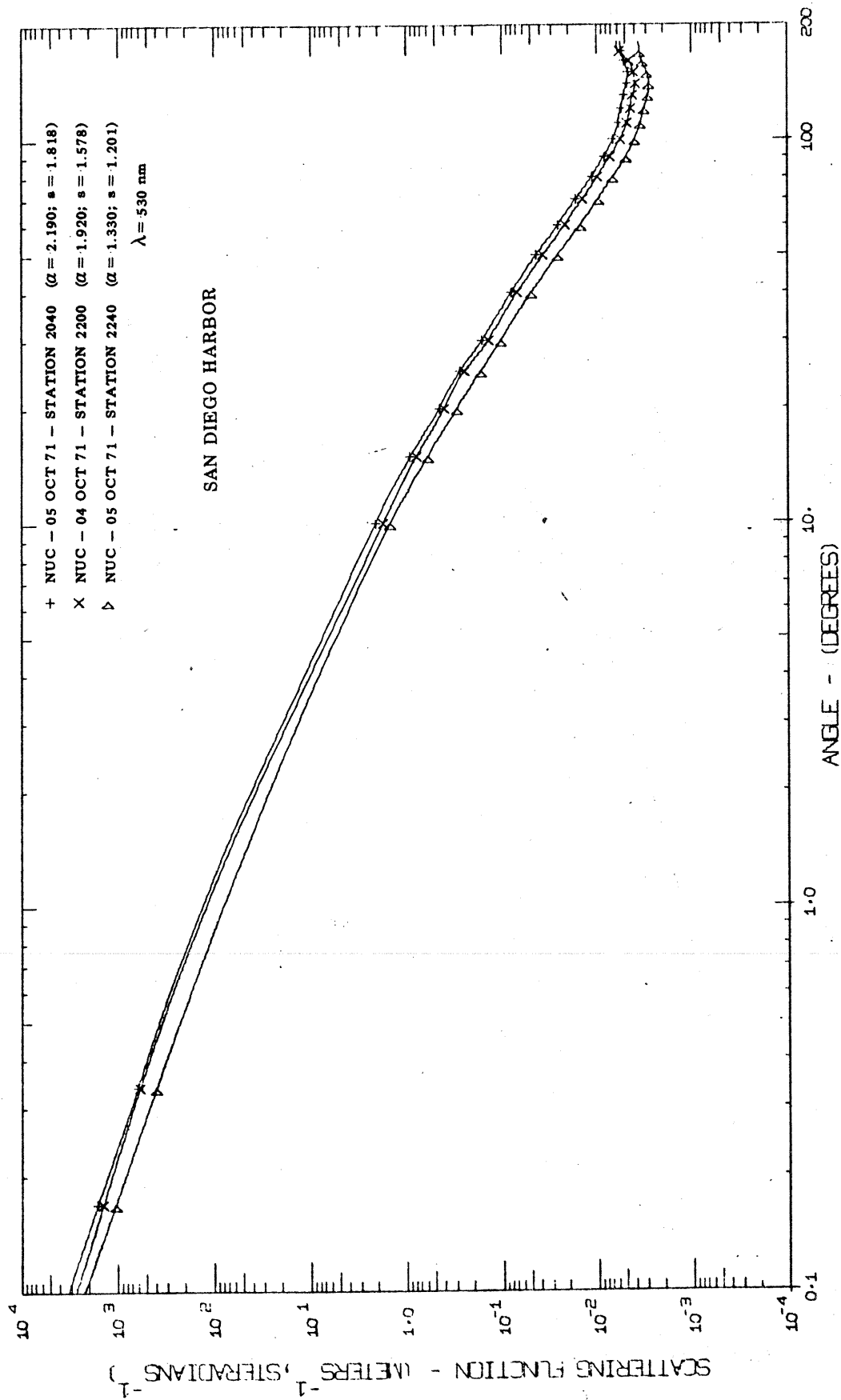

Figure 13

VOLUME SCATTERING FUNCTION

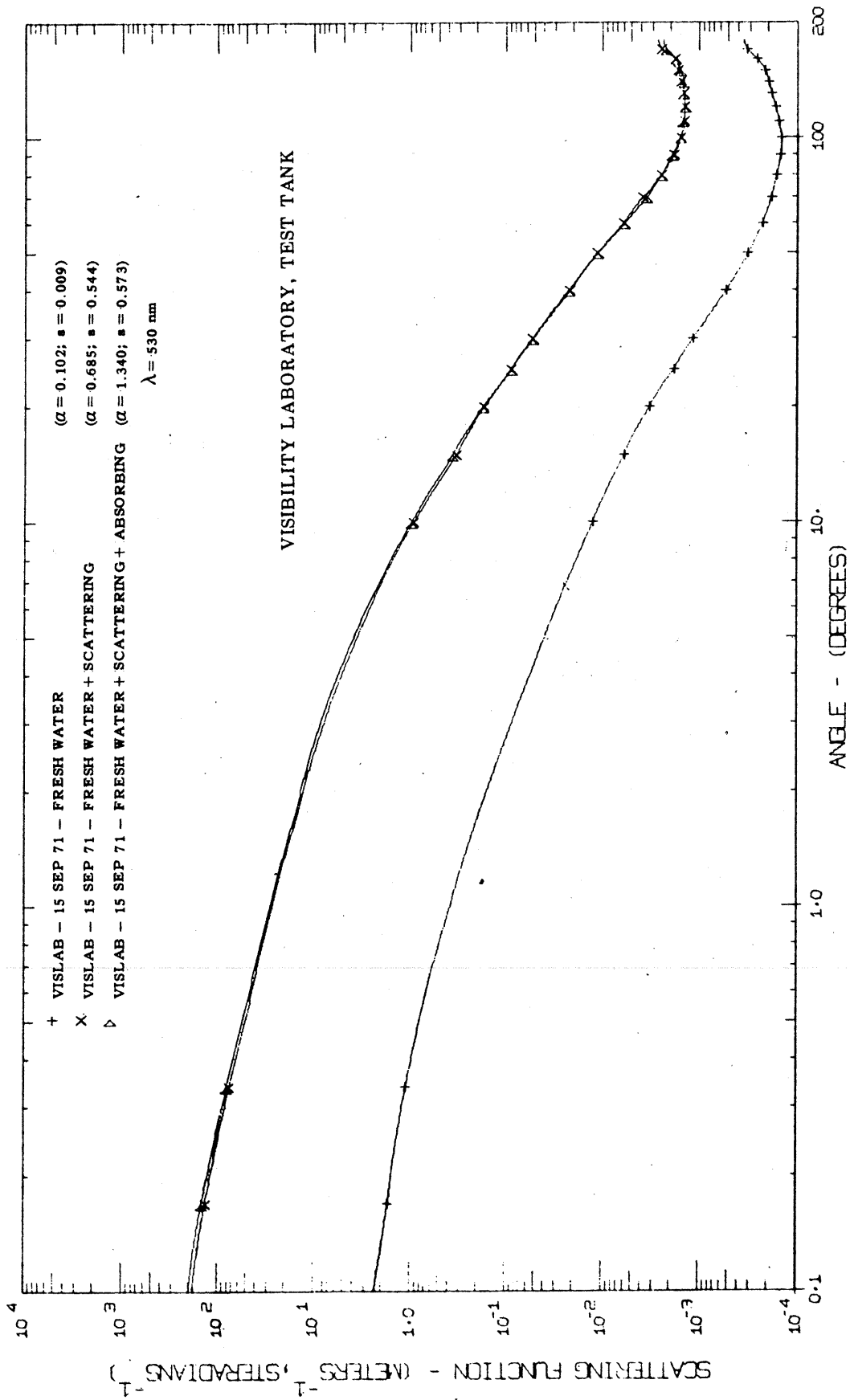

Figure 14

VOLUME SCATTERING FUNCTION

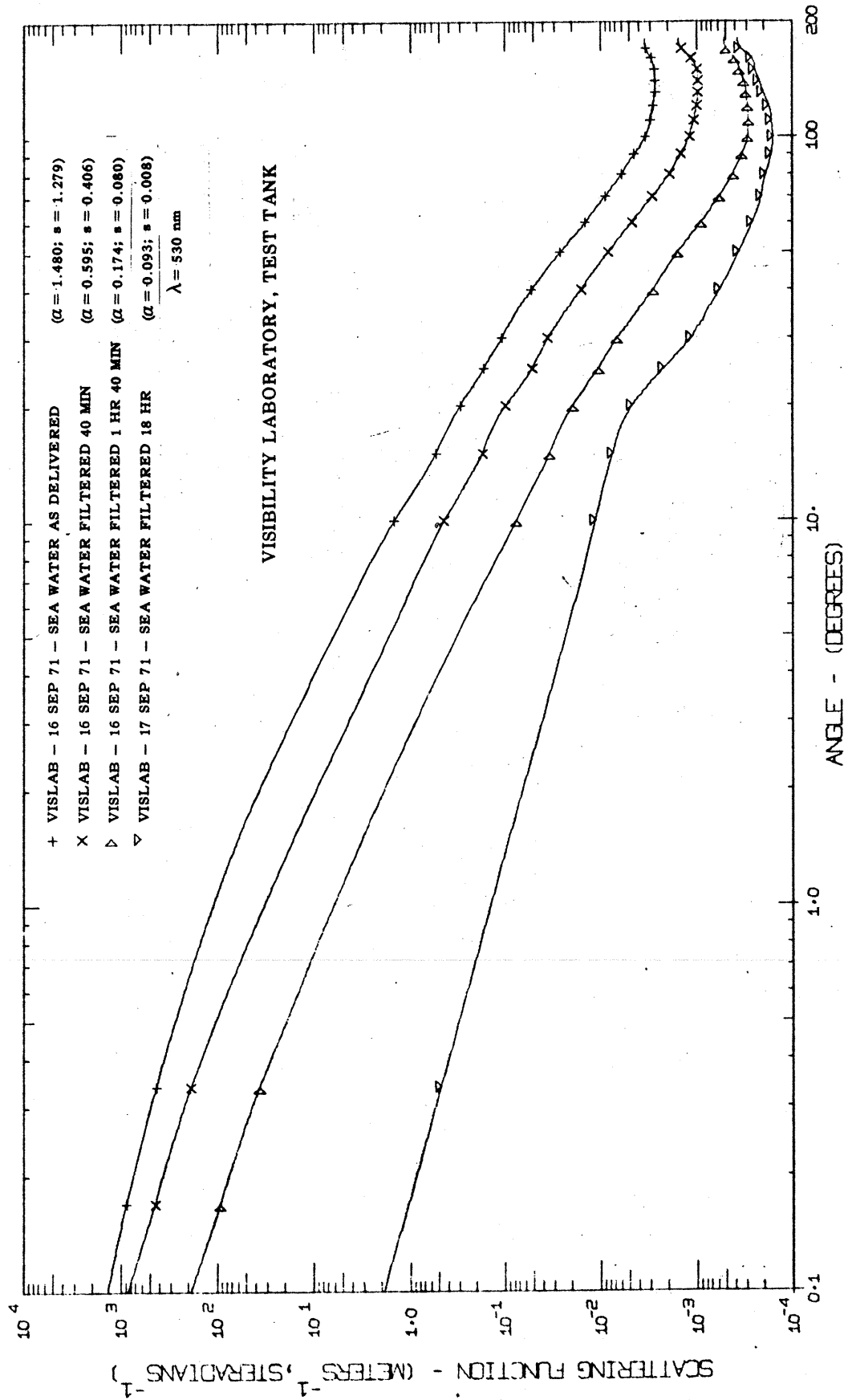

Figure 15

VOLUME SCATTERING DISTRIBUTION FUNCTION

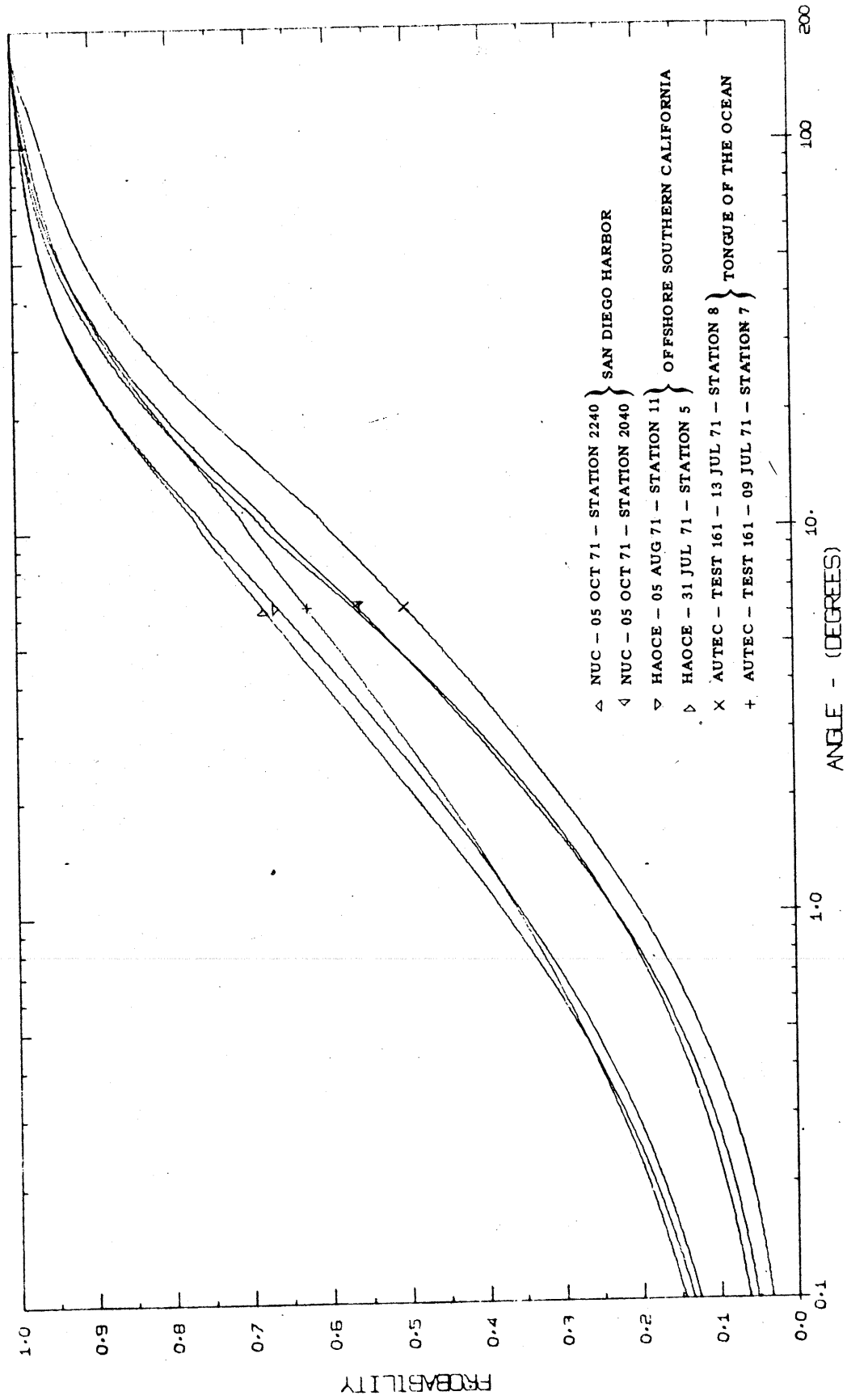

Figure 16

VOLUME SCATTERING DISTRIBUTION FUNCTION

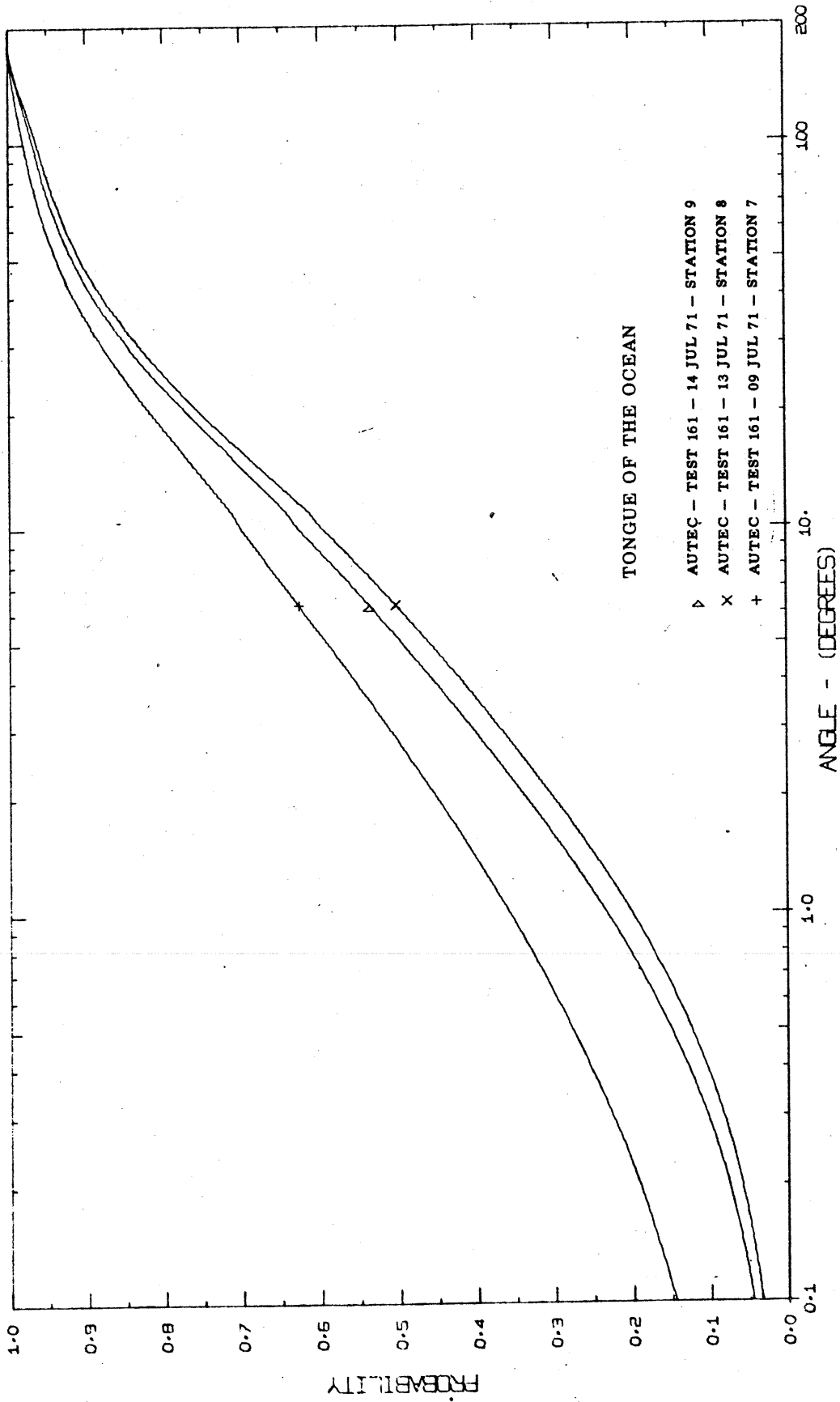

Figure 17

VOLUME SCATTERING DISTRIBUTION FUNCTION

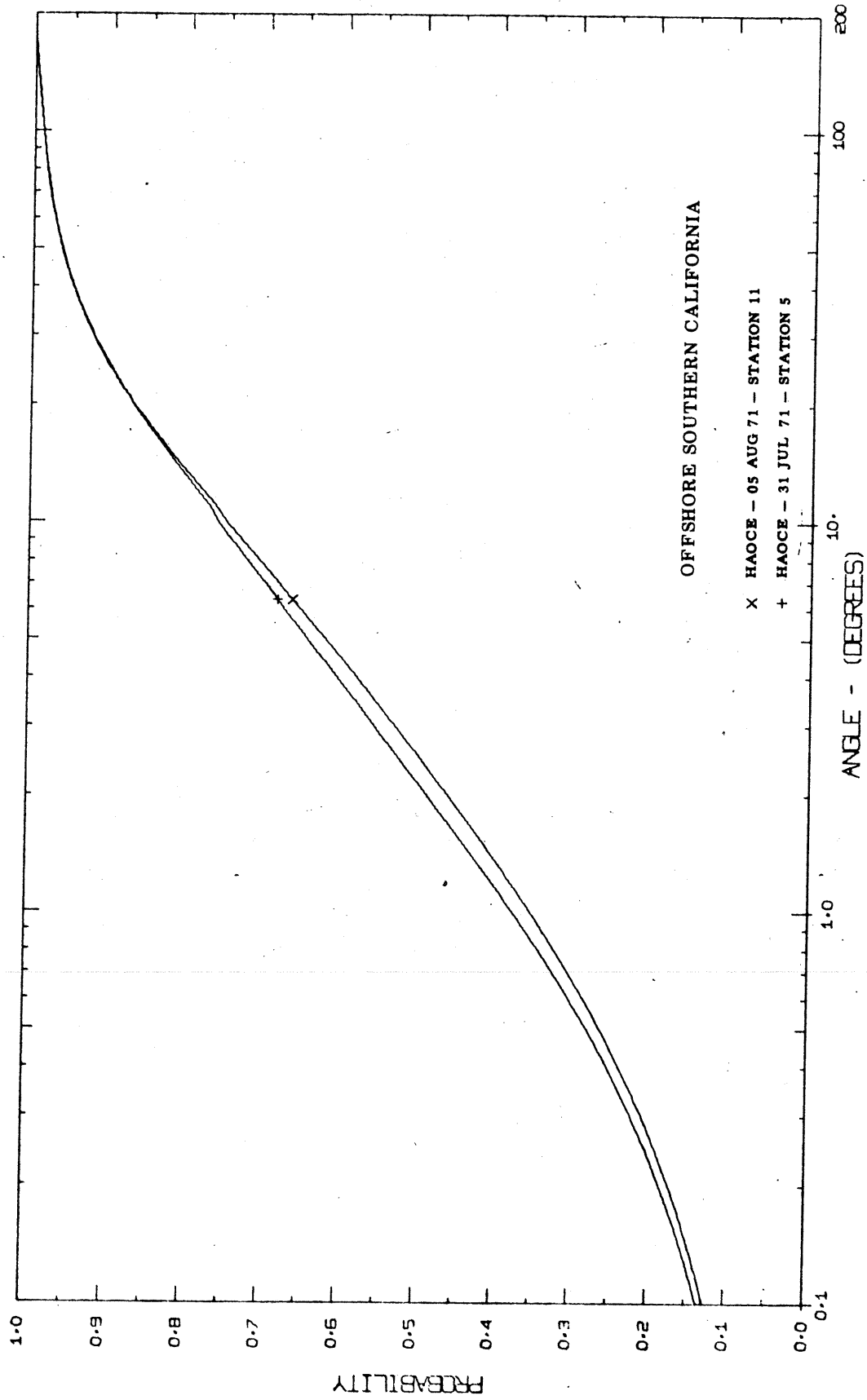

Figure 18

VOLUME SCATTERING DISTRIBUTION FUNCTION

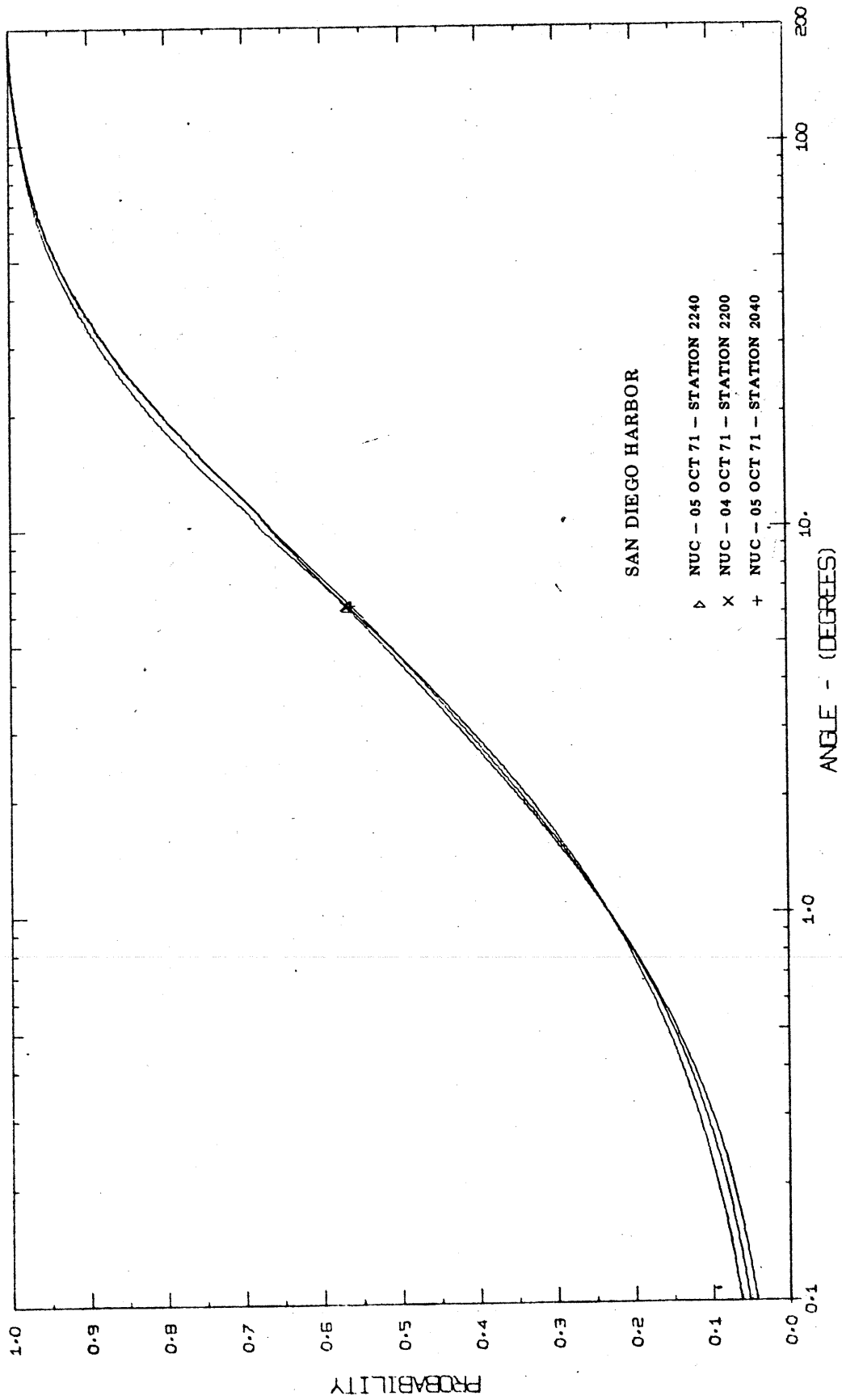

Figure 19

VOLUME SCATTERING DISTRIBUTION FUNCTION

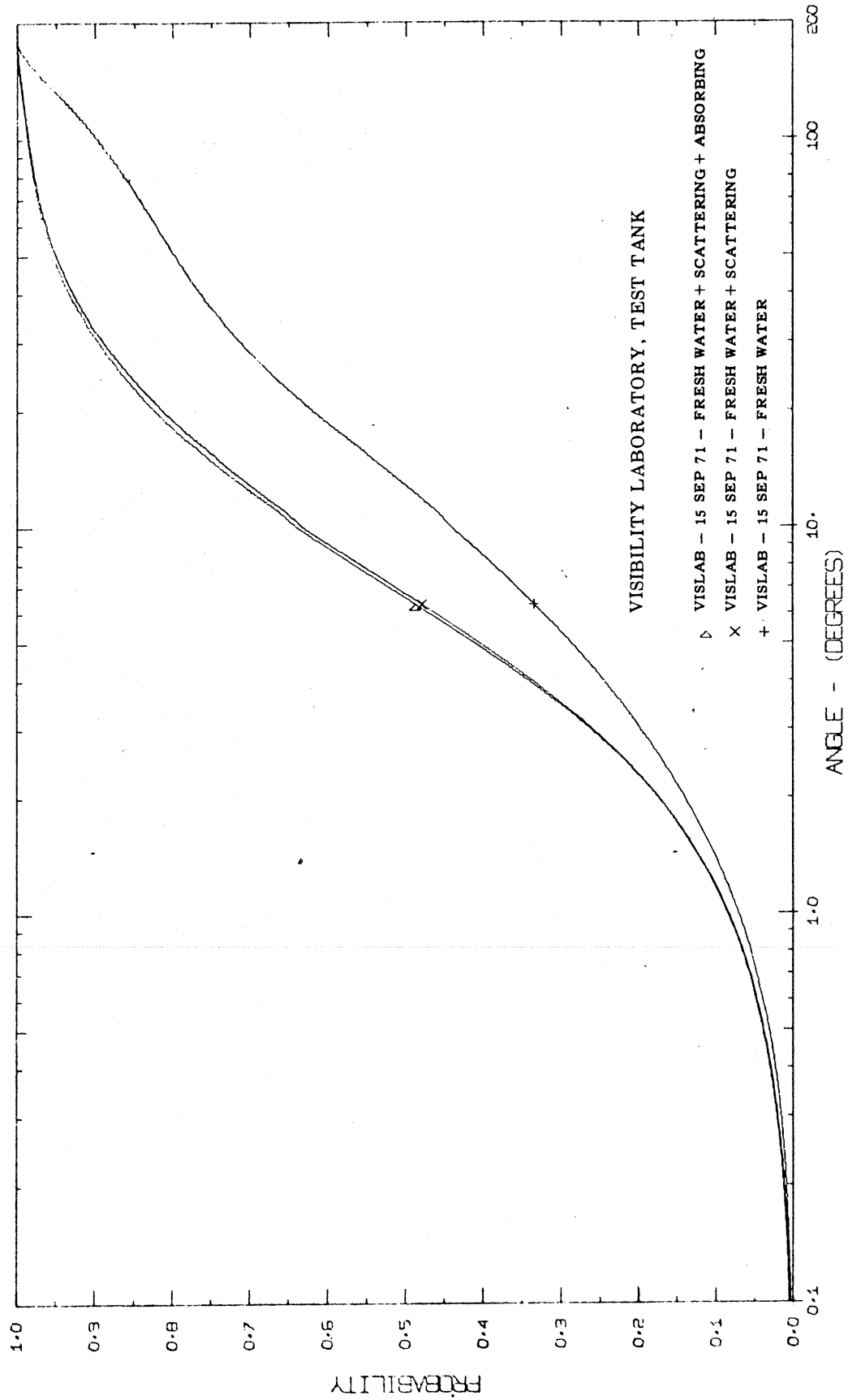

Figure 20

VOLUME SCATTERING DISTRIBUTION FUNCTION

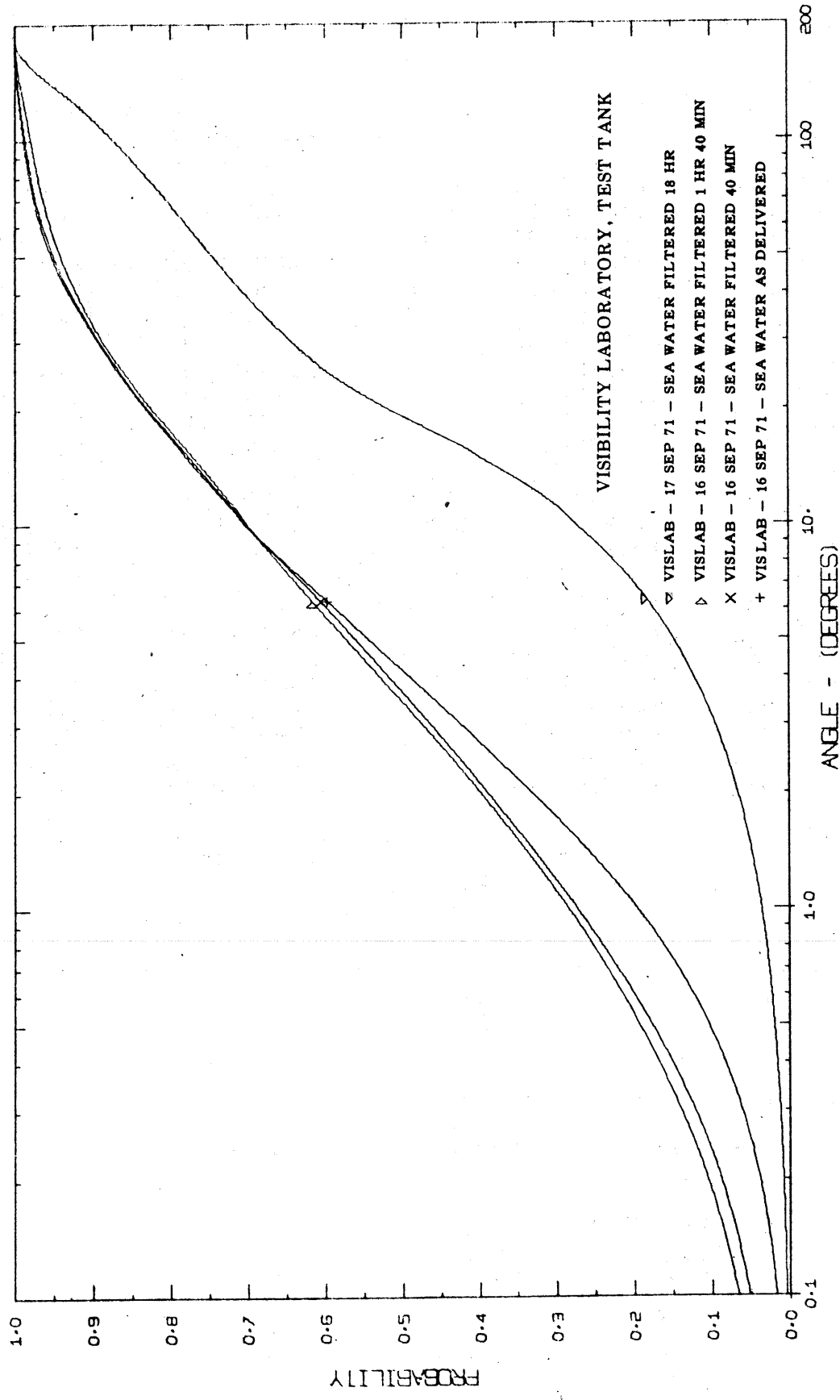

Figure 21

AUTEC - TEST 161 - 09JUL71 - STATION 7

	DATA READ IN			ITERATED DATA	
	ANGLE (DEG)	SIGMA		ANGLE (DEG)	SIGMA
1				1.0000E-01	3.5578E 02
2	1.6900E-01	1.6300E 02	0	1.6900E-01	1.5372E 02
3	3.3800E-01	5.3800E 01	0	3.3800E-01	5.0739E 01
4	5.7300E-01	2.1400E 01	10	5.7300E-01	2.0348E 01
5	1.7200E 00	3.0000E 00	10	1.7200E 00	2.9015E 00
6	5.7300E 00	3.0000E-01	10	5.7300E 00	2.9564E-01
7	1.0000E 01	1.0000E-01	0	1.0000E 01	9.9395E-02
8	1.5000E 01	4.7900E-02	0	1.5000E 01	4.7716E-02
9	2.0000E 01	2.6300E-02	0	2.0000E 01	2.6227E-02
10	2.5000E 01	1.5500E-02	0	2.5000E 01	1.5466E-02
11	3.0000E 01	9.7700E-03	0	3.0000E 01	9.7519E-03
12	4.0000E 01	4.6800E-03	0	4.0000E 01	4.6734E-03
13	5.0000E 01	2.4000E-03	0	5.0000E 01	2.3972E-03
14	6.0000E 01	1.4800E-03	0	6.0000E 01	1.4785E-03
15	7.0000E 01	1.0000E-03	0	7.0000E 01	9.9904E-04
16	8.0000E 01	7.0800E-04	0	8.0000E 01	7.0735E-04
17	9.0000E 01	5.3700E-04	0	9.0000E 01	5.3652E-04
18	1.0000E 02	4.6800E-04	0	1.0000E 02	4.6757E-04
19	1.1000E 02	4.4700E-04	0	1.1000E 02	4.4657E-04
20	1.2000E 02	4.2700E-04	0	1.2000E 02	4.2656E-04
21	1.3000E 02	4.3700E-04	0	1.3000E 02	4.3649E-04
22	1.4000E 02	4.3700E-04	0	1.4000E 02	4.3638E-04
23	1.5000E 02	4.9000E-04	0	1.5000E 02	4.8909E-04
24	1.6000E 02	5.7500E-04	0	1.6000E 02	5.7340E-04
25	1.7000E 02	7.5900E-04	0	1.7000E 02	7.5441E-04
26				1.8000E 02	8.1475E-04

ITERATIONS= 3
 ITERATION CHANGE IN S/ALPHA LESS THAN 0.10 PERCENT

ALPHA= 0.199	S/ALPHA= 0.588
S= 0.117	A/ALPHA= 0.412
A= 0.082	B/S= 0.025

$$\omega_0 = \frac{S}{\alpha} = 0.59$$

SIGMA(0.1 DEGREES)=	3.5578E 02	
SLOPE=	-1.599	
S UP TO 0.1 DEGREES=	1.6989E-02	NORMALIZED= 1.45091E-01

RATIO OF SIGMA(THETA) TO S				
THETA(DEG)	20.0	40.0	45.0	90.0
RATIO	2.2398E-01	3.9911E-02	2.7767E-02	4.5819E-03

	MU	RADIANS	DEGREES
MEDIAN	0.9988	0.4913E-01	2.815

AUTEC - TEST 161 - 09JUL71 - STATION 7

ANGLE(RAD)	ANGLE(DEG)	SIGMA	INTEGRAL	NORM. INTEGRAL	
1.7453E-03	1.0000E-01	3.5578E 02	1.6989E-02	1.4509E-01	1
2.1972E-03	1.2589E-01	2.4618E 02	1.8632E-02	1.5912E-01	11
2.7662E-03	1.5849E-01	1.7035E 02	2.0433E-02	1.7450E-01	21
3.4824E-03	1.9953E-01	1.1899E 02	2.2416E-02	1.9144E-01	31
4.3841E-03	2.5119E-01	8.2607E 01	2.4609E-02	2.1017E-01	41
5.5192E-03	3.1623E-01	5.6694E 01	2.7008E-02	2.3065E-01	51
6.9483E-03	3.9811E-01	3.8278E 01	2.9597E-02	2.5276E-01	61
8.7474E-03	5.0119E-01	2.5691E 01	3.2355E-02	2.7632E-01	71
1.1012E-02	6.3096E-01	1.7245E 01	3.5287E-02	3.0136E-01	81
1.3864E-02	7.9433E-01	1.1566E 01	3.8408E-02	3.2801E-01	91
1.7453E-02	1.0000E 00	7.7116E 00	4.1716E-02	3.5626E-01	101
2.1972E-02	1.2589E 00	5.1122E 00	4.5202E-02	3.8603E-01	111
2.7662E-02	1.5849E 00	3.3694E 00	4.8853E-02	4.1721E-01	121
3.4824E-02	1.9953E 00	2.2007E 00	5.2651E-02	4.4965E-01	131
4.3841E-02	2.5119E 00	1.4291E 00	5.6569E-02	4.8310E-01	141
5.5192E-02	3.1623E 00	9.2474E-01	6.0593E-02	5.1747E-01	151
6.9483E-02	3.9811E 00	5.9622E-01	6.4711E-02	5.5264E-01	161
8.7473E-02	5.0119E 00	3.8303E-01	6.8910E-02	5.8850E-01	171
1.1012E-01	6.3096E 00	2.4316E-01	7.3167E-02	6.2485E-01	181
1.3864E-01	7.9433E 00	1.5421E-01	7.7427E-02	6.6124E-01	191
1.7453E-01	1.0000E 01	9.9396E-02	8.1738E-02	6.9805E-01	201
2.6180E-01	1.5000E 01	4.7716E-02	8.9779E-02	7.6672E-01	206
3.4907E-01	2.0000E 01	2.6227E-02	9.5577E-02	8.1624E-01	211
4.3633E-01	2.5000E 01	1.5466E-02	9.9785E-02	8.5217E-01	216
5.2360E-01	3.0000E 01	9.7519E-03	1.0288E-01	8.7860E-01	221
6.1086E-01	3.5000E 01	6.6915E-03	1.0526E-01	8.9892E-01	226
6.9813E-01	4.0000E 01	4.6734E-03	1.0713E-01	9.1486E-01	231
7.8540E-01	4.5000E 01	3.2513E-03	1.0857E-01	9.2716E-01	236
8.7266E-01	5.0000E 01	2.3972E-03	1.0969E-01	9.3677E-01	241
9.5993E-01	5.5000E 01	1.8570E-03	1.1061E-01	9.4460E-01	246
1.0472E 00	6.0000E 01	1.4785E-03	1.1137E-01	9.5113E-01	251
1.1345E 00	6.5000E 01	1.2073E-03	1.1202E-01	9.5668E-01	256
1.2217E 00	7.0000E 01	9.9904E-04	1.1258E-01	9.6143E-01	261
1.3090E 00	7.5000E 01	8.3229E-04	1.1305E-01	9.6550E-01	266
1.3963E 00	8.0000E 01	7.0735E-04	1.1346E-01	9.6900E-01	271
1.4835E 00	8.5000E 01	6.0370E-04	1.1382E-01	9.7203E-01	276
1.5708E 00	9.0000E 01	5.3652E-04	1.1413E-01	9.7468E-01	281
1.6581E 00	9.5000E 01	4.9430E-04	1.1441E-01	9.7708E-01	286
1.7453E 00	1.0000E 02	4.6757E-04	1.1467E-01	9.7931E-01	291
1.8326E 00	1.0500E 02	4.5696E-04	1.1492E-01	9.8142E-01	296
1.9199E 00	1.1000E 02	4.4657E-04	1.1516E-01	9.8344E-01	301
2.0071E 00	1.1500E 02	4.3223E-04	1.1538E-01	9.8534E-01	306
2.0944E 00	1.2000E 02	4.2656E-04	1.1559E-01	9.8711E-01	311
2.1817E 00	1.2500E 02	4.3290E-04	1.1579E-01	9.8882E-01	316
2.2689E 00	1.3000E 02	4.3649E-04	1.1597E-01	9.9043E-01	321
2.3562E 00	1.3500E 02	4.2956E-04	1.1615E-01	9.9192E-01	326
2.4435E 00	1.4000E 02	4.3638E-04	1.1631E-01	9.9328E-01	331
2.5307E 00	1.4500E 02	4.5911E-04	1.1646E-01	9.9456E-01	336
2.6180E 00	1.5000E 02	4.8909E-04	1.1660E-01	9.9575E-01	341
2.7053E 00	1.5500E 02	5.2124E-04	1.1672E-01	9.9684E-01	346
2.7925E 00	1.6000E 02	5.7340E-04	1.1684E-01	9.9781E-01	351
2.8798E 00	1.6500E 02	6.4918E-04	1.1694E-01	9.9867E-01	356
2.9671E 00	1.7000E 02	7.5441E-04	1.1702E-01	9.9937E-01	361
3.0543E 00	1.7500E 02	7.8458E-04	1.1708E-01	9.9984E-01	366
3.1416E 00	1.8000E 02	8.1475E-04	1.1709E-01	1.0000E 00	371

Figure 23

AUTEC - TEST 161 - 13JUL71 - STATION 8

	DATA READ IN			ITERATED DATA	
	ANGLE (DEG)	SIGMA		ANGLE (DEG)	SIGMA
1				1.0000E-01	5.3182E 01
2	1.6900E-01	2.9000E 01	0	1.6900E-01	2.8464E 01
3	3.3800E-01	1.2700E 01	0	3.3800E-01	1.2465E 01
4	5.7300E-01	6.0000E 00	10	5.7300E-01	5.9045E 00
5	1.7200E 00	1.0300E 00	10	1.7200E 00	1.0191E 00
6	5.7300E 00	1.1400E-01	10	5.7300E 00	1.1347E-01
7	1.0000E 01	4.1700E-02	0	1.0000E 01	4.1620E-02
8	1.5000E 01	2.0400E-02	0	1.5000E 01	2.0375E-02
9	2.0000E 01	1.1000E-02	0	2.0000E 01	1.0990E-02
10	2.5000E 01	6.1700E-03	0	2.5000E 01	6.1656E-03
11	3.0000E 01	3.8900E-03	0	3.0000E 01	3.8877E-03
12	4.0000E 01	1.9000E-03	0	4.0000E 01	1.8991E-03
13	5.0000E 01	1.0200E-03	0	5.0000E 01	1.0196E-03
14	6.0000E 01	6.0300E-04	0	6.0000E 01	6.0280E-04
15	7.0000E 01	4.0700E-04	0	7.0000E 01	4.0688E-04
16	8.0000E 01	3.0200E-04	0	8.0000E 01	3.0191E-04
17	9.0000E 01	2.4600E-04	0	9.0000E 01	2.4593E-04
18	1.0000E 02	2.2400E-04	0	1.0000E 02	2.2394E-04
19	1.1000E 02	2.2400E-04	0	1.1000E 02	2.2393E-04
20	1.2000E 02	2.3400E-04	0	1.2000E 02	2.3392E-04
21	1.3000E 02	2.6300E-04	0	1.3000E 02	2.6290E-04
22	1.4000E 02	2.7500E-04	0	1.4000E 02	2.7488E-04
23	1.5000E 02	3.0900E-04	0	1.5000E 02	3.0882E-04
24	1.6000E 02	3.6300E-04	0	1.6000E 02	3.6268E-04
25	1.7000E 02	4.6800E-04	0	1.7000E 02	4.6710E-04
26				1.8000E 02	5.0190E-04

ITERATIONS= 3
 ITERATION CHANGE IN S/ALPHA LESS THAN 0.10 PERCENT

ALPHA= 0.151 S/ALPHA= 0.247
 S= 0.037 A/ALPHA= 0.753
 A= 0.114 B/S= 0.044

SIGMA(0.1 DEGREES)= 5.3182E 01
 SLOPE= -1.191
 S UP TO 0.1 DEGREES= 1.2585E-03 NORMALIZED= 3.37509E-02

RATIO OF SIGMA(THETA) TO S

THETA(DEG)	20.0	40.0	45.0	90.0
RATIO	2.9474E-01	5.0931E-02	3.6785E-02	6.5953E-03

MEDIAN MU RADIANS DEGREES

0.9941 0.1091 6.252

AUTEC - TEST 161 - 13JUL71 - STATION 8

ANGLE(RAD)	ANGLE(DEG)	SIGMA	INTEGRAL	NORM. INTEGRAL	
1.7453E-03	1.0000E-01	5.3182E 01	1.2585E-03	3.3751E-02	1
2.1972E-03	1.2589E-01	4.0424E 01	1.5161E-03	4.0660E-02	11
2.7662E-03	1.5849E-01	3.0727E 01	1.8265E-03	4.8983E-02	21
3.4824E-03	1.9953E-01	2.3735E 01	2.2029E-03	5.9077E-02	31
4.3841E-03	2.5119E-01	1.8141E 01	2.6627E-03	7.1407E-02	41
5.5192E-03	3.1623E-01	1.3598E 01	3.2140E-03	8.6194E-02	51
6.9483E-03	3.9811E-01	9.9536E 00	3.8614E-03	1.0355E-01	61
8.7474E-03	5.0119E-01	7.1793E 00	4.6060E-03	1.2352E-01	71
1.1012E-02	6.3096E-01	5.1100E 00	5.4518E-03	1.4621E-01	81
1.3864E-02	7.9433E-01	3.5911E 00	6.3992E-03	1.7161E-01	91
1.7453E-02	1.0000E 00	2.4976E 00	7.4489E-03	1.9976E-01	101
2.1972E-02	1.2589E 00	1.7191E 00	8.5998E-03	2.3063E-01	111
2.7662E-02	1.5849E 00	1.1710E 00	9.8486E-03	2.6412E-01	121
3.4824E-02	1.9953E 00	7.7576E-01	1.1182E-02	2.9987E-01	131
4.3841E-02	2.5119E 00	5.0866E-01	1.2569E-02	3.3707E-01	141
5.5192E-02	3.1623E 00	3.3399E-01	1.4011E-02	3.7574E-01	151
6.9483E-02	3.9811E 00	2.1960E-01	1.5512E-02	4.1601E-01	161
8.7473E-02	5.0119E 00	1.4459E-01	1.7078E-02	4.5798E-01	171
1.1012E-01	6.3096E 00	9.5219E-02	1.8711E-02	5.0178E-01	181
1.3864E-01	7.9433E 00	6.2816E-02	2.0414E-02	5.4746E-01	191
1.7453E-01	1.0000E 01	4.1620E-02	2.2196E-02	5.9525E-01	201
2.6180E-01	1.5000E 01	2.0375E-02	2.5612E-02	6.8686E-01	206
3.4907E-01	2.0000E 01	1.0990E-02	2.8075E-02	7.5292E-01	211
4.3633E-01	2.5000E 01	6.1656E-03	2.9789E-02	7.9888E-01	216
5.2360E-01	3.0000E 01	3.8877E-03	3.1021E-02	8.3190E-01	221
6.1086E-01	3.5000E 01	2.6802E-03	3.1972E-02	8.5741E-01	226
6.9813E-01	4.0000E 01	1.8991E-03	3.2723E-02	8.7756E-01	231
7.8540E-01	4.5000E 01	1.3717E-03	3.3321E-02	8.9360E-01	236
8.7266E-01	5.0000E 01	1.0196E-03	3.3798E-02	9.0638E-01	241
9.5993E-01	5.5000E 01	7.6833E-04	3.4183E-02	9.1672E-01	246
1.0472E 00	6.0000E 01	6.0280E-04	3.4496E-02	9.2511E-01	251
1.1345E 00	6.5000E 01	4.8832E-04	3.4761E-02	9.3220E-01	256
1.2217E 00	7.0000E 01	4.0688E-04	3.4985E-02	9.3822E-01	261
1.3090E 00	7.5000E 01	3.4571E-04	3.5182E-02	9.4350E-01	266
1.3963E 00	8.0000E 01	3.0191E-04	3.5353E-02	9.4809E-01	271
1.4835E 00	8.5000E 01	2.6810E-04	3.5509E-02	9.5226E-01	276
1.5708E 00	9.0000E 01	2.4593E-04	3.5648E-02	9.5599E-01	281
1.6581E 00	9.5000E 01	2.3152E-04	3.5779E-02	9.5952E-01	286
1.7453E 00	1.0000E 02	2.2394E-04	3.5902E-02	9.6280E-01	291
1.8326E 00	1.0500E 02	2.2254E-04	3.6022E-02	9.6603E-01	296
1.9199E 00	1.1000E 02	2.2393E-04	3.6137E-02	9.6913E-01	301
2.0071E 00	1.1500E 02	2.2651E-04	3.6253E-02	9.7221E-01	306
2.0944E 00	1.2000E 02	2.3392E-04	3.6363E-02	9.7518E-01	311
2.1817E 00	1.2500E 02	2.5050E-04	3.6476E-02	9.7822E-01	316
2.2689E 00	1.3000E 02	2.6290E-04	3.6587E-02	9.8118E-01	321
2.3562E 00	1.3500E 02	2.6615E-04	3.6695E-02	9.8407E-01	326
2.4435E 00	1.4000E 02	2.7488E-04	3.6794E-02	9.8672E-01	331
2.5307E 00	1.4500E 02	2.8957E-04	3.6889E-02	9.8928E-01	336
2.6180E 00	1.5000E 02	3.0882E-04	3.6975E-02	9.9160E-01	341
2.7053E 00	1.5500E 02	3.3044E-04	3.7057E-02	9.9380E-01	346
2.7925E 00	1.6000E 02	3.6268E-04	3.7128E-02	9.9570E-01	351
2.8798E 00	1.6500E 02	4.0732E-04	3.7193E-02	9.9743E-01	356
2.9671E 00	1.7000E 02	4.6710E-04	3.7243E-02	9.9877E-01	361
3.0543E 00	1.7500E 02	4.8450E-04	3.7278E-02	9.9972E-01	366
3.1416E 00	1.8000E 02	5.0190E-04	3.7289E-02	1.0000E 00	371

AUTEC - TEST 161 - 14JUL71 - STATION 9

	DATA READ IN			ITERATED DATA	
	ANGLE (DEG)	SIGMA		ANGLE (DEG)	SIGMA
1				1.0000E-01	7.5181E 01
2	1.6900E-01	3.9900E 01	0	1.6900E-01	3.9059E 01
3	3.3800E-01	1.6800E 01	0	3.3800E-01	1.6446E 01
4	5.7300E-01	7.5000E 00	10	5.7300E-01	7.3639E 00
5	1.7200E 00	1.2000E 00	10	1.7200E 00	1.1855E 00
6	5.7300E 00	1.2700E-01	10	5.7300E 00	1.2633E-01
7	1.0000E 01	4.4700E-02	0	1.0000E 01	4.4602E-02
8	1.5000E 01	2.0900E-02	0	1.5000E 01	2.0871E-02
9	2.0000E 01	1.2000E-02	0	2.0000E 01	1.1988E-02
10	2.5000E 01	7.0800E-03	0	2.5000E 01	7.0743E-03
11	3.0000E 01	4.2700E-03	0	3.0000E 01	4.2671E-03
12	4.0000E 01	2.0000E-03	0	4.0000E 01	1.9990E-03
13	5.0000E 01	1.0700E-03	0	5.0000E 01	1.0695E-03
14	6.0000E 01	6.4600E-04	0	6.0000E 01	6.4576E-04
15	7.0000E 01	4.3700E-04	0	7.0000E 01	4.3685E-04
16	8.0000E 01	3.0900E-04	0	8.0000E 01	3.0890E-04
17	9.0000E 01	2.4600E-04	0	9.0000E 01	2.4592E-04
18	1.0000E 02	2.1900E-04	0	1.0000E 02	2.1893E-04
19	1.1000E 02	2.1900E-04	0	1.1000E 02	2.1892E-04
20	1.2000E 02	2.2900E-04	0	1.2000E 02	2.2891E-04
21	1.3000E 02	2.5700E-04	0	1.3000E 02	2.5689E-04
22	1.4000E 02	2.7500E-04	0	1.4000E 02	2.7486E-04
23	1.5000E 02	3.0200E-04	0	1.5000E 02	3.0180E-04
24	1.6000E 02	3.4700E-04	0	1.6000E 02	3.4665E-04
25	1.7000E 02	4.6800E-04	0	1.7000E 02	4.6697E-04
26				1.8000E 02	5.0708E-04

ITERATIONS= 3
 ITERATION CHANGE IN S/ALPHA LESS THAN 0.10 PERCENT

ALPHA= 0.165	S/ALPHA= 0.258
S= 0.043	A/ALPHA= 0.742
A= 0.122	B/S= 0.038

SIGMA(0.1 DEGREES)=	7.5181E 01	
SLOPE=	-1.248	
S UP TO 0.1 DEGREES=	1.9133E-03	NORMALIZED= 4.49257E-02

RATIO OF SIGMA(THETA) TO S				
THETA(DEG)	20.0	40.0	45.0	90.0
RATIO	2.8149E-01	4.6939E-02	3.3705E-02	5.7745E-03

MEDIAN	MU	RADIANS	DEGREES
	0.9959	0.9081E-01	5.203

AUTEC - TEST 161 - 14JUL71 - STATION 9

ANGLE(RAD)	ANGLE(DEG)	SIGMA	INTEGRAL	NORM. INTEGRAL	
1.7453E-03	1.0000E-01	7.5181E 01	1.9133E-03	4.4926E-02	1
2.1972E-03	1.2589E-01	5.6404E 01	2.2750E-03	5.3420E-02	11
2.7662E-03	1.5849E-01	4.2318E 01	2.7051E-03	6.3520E-02	21
3.4824E-03	1.9953E-01	3.2379E 01	3.2208E-03	7.5629E-02	31
4.3841E-03	2.5119E-01	2.4458E 01	3.8444E-03	9.0272E-02	41
5.5192E-03	3.1623E-01	1.8039E 01	4.5819E-03	1.0759E-01	51
6.9483E-03	3.9811E-01	1.2885E 01	5.4306E-03	1.2752E-01	61
8.7474E-03	5.0119E-01	9.0697E 00	6.3824E-03	1.4987E-01	71
1.1012E-02	6.3096E-01	6.3271E 00	7.4393E-03	1.7468E-01	81
1.3864E-02	7.9433E-01	4.3741E 00	8.6025E-03	2.0200E-01	91
1.7453E-02	1.0000E 00	2.9964E 00	9.8711E-03	2.3179E-01	101
2.1972E-02	1.2589E 00	2.0339E 00	1.1242E-02	2.6398E-01	111
2.7662E-02	1.5849E 00	1.3679E 00	1.2710E-02	2.9845E-01	121
3.4824E-02	1.9953E 00	9.0011E-01	1.4261E-02	3.3486E-01	131
4.3841E-02	2.5119E 00	5.8691E-01	1.5866E-02	3.7255E-01	141
5.5192E-02	3.1623E 00	3.8249E-01	1.7524E-02	4.1148E-01	151
6.9483E-02	3.9811E 00	2.4913E-01	1.9235E-02	4.5167E-01	161
8.7473E-02	5.0119E 00	1.6219E-01	2.1001E-02	4.9314E-01	171
1.1012E-01	6.3096E 00	1.0552E-01	2.2822E-02	5.3588E-01	181
1.3864E-01	7.9433E 00	6.8616E-02	2.4696E-02	5.7990E-01	191
1.7453E-01	1.0000E 01	4.4602E-02	2.6625E-02	6.2519E-01	201
2.6180E-01	1.5000E 01	2.0871E-02	3.0157E-02	7.0812E-01	206
3.4907E-01	2.0000E 01	1.1988E-02	3.2759E-02	7.6922E-01	211
4.3633E-01	2.5000E 01	7.0743E-03	3.4693E-02	8.1464E-01	216
5.2360E-01	3.0000E 01	4.2671E-03	3.6075E-02	8.4709E-01	221
6.1086E-01	3.5000E 01	2.8615E-03	3.7103E-02	8.7123E-01	226
6.9813E-01	4.0000E 01	1.9990E-03	3.7900E-02	8.8993E-01	231
7.8540E-01	4.5000E 01	1.4354E-03	3.8527E-02	9.0466E-01	236
8.7266E-01	5.0000E 01	1.0695E-03	3.9026E-02	9.1639E-01	241
9.5993E-01	5.5000E 01	8.1689E-04	3.9433E-02	9.2593E-01	246
1.0472E 00	6.0000E 01	6.4576E-04	3.9767E-02	9.3379E-01	251
1.1345E 00	6.5000E 01	5.2780E-04	4.0052E-02	9.4047E-01	256
1.2217E 00	7.0000E 01	4.3685E-04	4.0294E-02	9.4616E-01	261
1.3090E 00	7.5000E 01	3.6098E-04	4.0502E-02	9.5104E-01	266
1.3963E 00	8.0000E 01	3.0890E-04	4.0680E-02	9.5521E-01	271
1.4835E 00	8.5000E 01	2.7117E-04	4.0837E-02	9.5891E-01	276
1.5708E 00	9.0000E 01	2.4592E-04	4.0978E-02	9.6221E-01	281
1.6581E 00	9.5000E 01	2.2817E-04	4.1108E-02	9.6527E-01	286
1.7453E 00	1.0000E 02	2.1893E-04	4.1228E-02	9.6809E-01	291
1.8326E 00	1.0500E 02	2.1753E-04	4.1346E-02	9.7085E-01	296
1.9199E 00	1.1000E 02	2.1892E-04	4.1459E-02	9.7351E-01	301
2.0071E 00	1.1500E 02	2.2163E-04	4.1571E-02	9.7614E-01	306
2.0944E 00	1.2000E 02	2.2891E-04	4.1680E-02	9.7869E-01	311
2.1817E 00	1.2500E 02	2.4411E-04	4.1790E-02	9.8128E-01	316
2.2689E 00	1.3000E 02	2.5689E-04	4.1898E-02	9.8382E-01	321
2.3562E 00	1.3500E 02	2.6476E-04	4.2004E-02	9.8631E-01	326
2.4435E 00	1.4000E 02	2.7486E-04	4.2103E-02	9.8864E-01	331
2.5307E 00	1.4500E 02	2.8622E-04	4.2197E-02	9.9085E-01	336
2.6180E 00	1.5000E 02	3.0180E-04	4.2283E-02	9.9286E-01	341
2.7053E 00	1.5500E 02	3.1644E-04	4.2362E-02	9.9470E-01	346
2.7925E 00	1.6000E 02	3.4665E-04	4.2430E-02	9.9631E-01	351
2.8798E 00	1.6500E 02	3.9514E-04	4.2491E-02	9.9775E-01	356
2.9671E 00	1.7000E 02	4.6697E-04	4.2541E-02	9.9892E-01	361
3.0543E 00	1.7500E 02	4.8702E-04	4.2576E-02	9.9974E-01	366
3.1416E 00	1.8000E 02	5.0708E-04	4.2587E-02	1.0000E 00	371

HAOCE - 31JUL71 - STATION 5

	DATA READ IN			ITERATED DATA	
	ANGLE (DEG)	SIGMA		ANGLE (DEG)	SIGMA
1				1.0000E-01	8.7125E 02
2	1.6900E-01	4.4400E 02	0	1.6900E-01	3.8701E 02
3	3.3800E-01	1.5200E 02	0	3.3800E-01	1.3249E 02
4	5.7300E-01	6.5000E 01	10	5.7300E-01	5.7757E 01
5	1.7200E 00	8.8000E 00	10	1.7200E 00	8.1372E 00
6	5.7300E 00	7.6000E-01	10	5.7300E 00	7.3434E-01
7	1.0000E 01	2.4500E-01	0	1.0000E 01	2.4154E-01
8	1.5000E 01	1.0800E-01	0	1.5000E 01	1.0703E-01
9	2.0000E 01	5.4500E-02	0	2.0000E 01	5.4145E-02
10	2.5000E 01	3.0600E-02	0	2.5000E 01	3.0441E-02
11	3.0000E 01	1.7100E-02	0	3.0000E 01	1.7026E-02
12	4.0000E 01	7.2400E-03	0	4.0000E 01	7.2160E-03
13	5.0000E 01	3.8200E-03	0	5.0000E 01	3.8094E-03
14	6.0000E 01	2.1600E-03	0	6.0000E 01	2.1547E-03
15	7.0000E 01	1.3800E-03	0	7.0000E 01	1.3769E-03
16	8.0000E 01	9.3600E-04	0	8.0000E 01	9.3400E-04
17	9.0000E 01	7.2000E-04	0	9.0000E 01	7.1848E-04
18	1.0000E 02	5.7700E-04	0	1.0000E 02	5.7577E-04
19	1.1000E 02	5.1500E-04	0	1.1000E 02	5.1384E-04
20	1.2000E 02	4.9500E-04	0	1.2000E 02	4.9379E-04
21	1.3000E 02	5.1200E-04	0	1.3000E 02	5.1058E-04
22	1.4000E 02	5.7500E-04	0	1.4000E 02	5.7309E-04
23	1.5000E 02	6.6500E-04	0	1.5000E 02	6.6212E-04
24	1.6000E 02	8.0600E-04	0	1.6000E 02	8.0075E-04
25	1.7000E 02	1.3150E-03	0	1.7000E 02	1.2964E-03
26				1.8000E 02	1.4616E-03

ITERATIONS= 4
 ITERATION CHANGE IN S/ALPHA LESS THAN 0.10 PERCENT

ALPHA= 0.470	S/ALPHA= 0.585
S= 0.275	A/ALPHA= 0.415
A= 0.195	B/S= 0.014

SIGMA(0.1 DEGREES)=	8.7125E 02	
SLOPE=	-1.546	
S UP TO 0.1 DEGREES=	3.6769E-02	NORMALIZED= 1.33797E-01

RATIO OF SIGMA(THETA) TO S				
THETA(DEG)	20.0	40.0	45.0	90.0
RATIO	1.9702E-01	2.6258E-02	1.8893E-02	2.6144E-03

	MU	RADIANS	DEGREES
MEDIAN	0.9993	0.3757E-01	2.152

HAOCE - 31JUL71 - STATION 5

ANGLE(RAD)	ANGLE(DEG)	SIGMA	INTEGRAL	NORM. INTEGRAL	
1.7453E-03	1.0000E-01	8.7125E 02	3.6769E-02	1.3380E-01	1
2.1972E-03	1.2589E-01	6.1023E 02	4.0817E-02	1.4852E-01	11
2.7662E-03	1.5849E-01	4.2741E 02	4.5309E-02	1.6487E-01	21
3.4824E-03	1.9953E-01	2.9993E 02	5.0301E-02	1.8304E-01	31
4.3841E-03	2.5119E-01	2.1021E 02	5.5850E-02	2.0323E-01	41
5.5192E-03	3.1623E-01	1.4699E 02	6.2008E-02	2.2564E-01	51
6.9483E-03	3.9811E-01	1.0321E 02	6.8842E-02	2.5050E-01	61
8.7474E-03	5.0119E-01	7.1786E 01	7.6422E-02	2.7809E-01	71
1.1012E-02	6.3096E-01	4.9083E 01	8.4714E-02	3.0826E-01	81
1.3864E-02	7.9433E-01	3.3035E 01	9.3617E-02	3.4066E-01	91
1.7453E-02	1.0000E 00	2.2014E 01	1.0307E-01	3.7504E-01	101
2.1972E-02	1.2589E 00	1.4525E 01	1.1299E-01	4.1117E-01	111
2.7662E-02	1.5849E 00	9.4888E 00	1.2333E-01	4.4876E-01	121
3.4824E-02	1.9953E 00	6.0470E 00	1.3391E-01	4.8729E-01	131
4.3841E-02	2.5119E 00	3.8159E 00	1.4452E-01	5.2589E-01	141
5.5192E-02	3.1623E 00	2.4083E 00	1.5513E-01	5.6449E-01	151
6.9483E-02	3.9811E 00	1.5201E 00	1.6574E-01	6.0309E-01	161
8.7473E-02	5.0119E 00	9.5955E-01	1.7635E-01	6.4169E-01	171
1.1012E-01	6.3096E 00	6.0612E-01	1.8695E-01	6.8030E-01	181
1.3864E-01	7.9433E 00	3.8285E-01	1.9757E-01	7.1892E-01	191
1.7453E-01	1.0000E 01	2.4154E-01	2.0817E-01	7.5750E-01	201
2.6180E-01	1.5000E 01	1.0703E-01	2.2701E-01	8.2605E-01	206
3.4907E-01	2.0000E 01	5.4145E-02	2.3947E-01	8.7139E-01	211
4.3633E-01	2.5000E 01	3.0441E-02	2.4803E-01	9.0252E-01	216
5.2360E-01	3.0000E 01	1.7026E-02	2.5377E-01	9.2341E-01	221
6.1086E-01	3.5000E 01	1.0696E-02	2.5772E-01	9.3780E-01	226
6.9813E-01	4.0000E 01	7.2160E-03	2.6065E-01	9.4847E-01	231
7.8540E-01	4.5000E 01	5.1921E-03	2.6291E-01	9.5669E-01	236
8.7266E-01	5.0000E 01	3.8094E-03	2.6472E-01	9.6326E-01	241
9.5993E-01	5.5000E 01	2.8128E-03	2.6613E-01	9.6840E-01	246
1.0472E 00	6.0000E 01	2.1547E-03	2.6728E-01	9.7257E-01	251
1.1345E 00	6.5000E 01	1.7077E-03	2.6820E-01	9.7593E-01	256
1.2217E 00	7.0000E 01	1.3769E-03	2.6898E-01	9.7879E-01	261
1.3090E 00	7.5000E 01	1.1132E-03	2.6962E-01	9.8111E-01	266
1.3963E 00	8.0000E 01	9.3400E-04	2.7018E-01	9.8312E-01	271
1.4835E 00	8.5000E 01	8.1444E-04	2.7064E-01	9.8481E-01	276
1.5708E 00	9.0000E 01	7.1848E-04	2.7107E-01	9.8637E-01	281
1.6581E 00	9.5000E 01	6.3331E-04	2.7143E-01	9.8768E-01	286
1.7453E 00	1.0000E 02	5.7577E-04	2.7176E-01	9.8890E-01	291
1.8326E 00	1.0500E 02	5.3823E-04	2.7205E-01	9.8995E-01	296
1.9199E 00	1.1000E 02	5.1384E-04	2.7234E-01	9.9098E-01	301
2.0071E 00	1.1500E 02	4.9853E-04	2.7258E-01	9.9188E-01	306
2.0944E 00	1.2000E 02	4.9379E-04	2.7283E-01	9.9279E-01	311
2.1817E 00	1.2500E 02	4.9637E-04	2.7305E-01	9.9359E-01	316
2.2689E 00	1.3000E 02	5.1058E-04	2.7328E-01	9.9442E-01	321
2.3562E 00	1.3500E 02	5.3875E-04	2.7348E-01	9.9515E-01	326
2.4435E 00	1.4000E 02	5.7309E-04	2.7370E-01	9.9593E-01	331
2.5307E 00	1.4500E 02	6.1210E-04	2.7388E-01	9.9662E-01	336
2.6180E 00	1.5000E 02	6.6212E-04	2.7408E-01	9.9733E-01	341
2.7053E 00	1.5500E 02	6.9954E-04	2.7424E-01	9.9792E-01	346
2.7925E 00	1.6000E 02	8.0075E-04	2.7441E-01	9.9852E-01	351
2.8798E 00	1.6500E 02	9.8574E-04	2.7454E-01	9.9902E-01	356
2.9671E 00	1.7000E 02	1.2964E-03	2.7468E-01	9.9953E-01	361
3.0543E 00	1.7500E 02	1.3790E-03	2.7477E-01	9.9985E-01	366
3.1416E 00	1.8000E 02	1.4616E-03	2.7481E-01	1.0000E 00	371

HAOCE - 05AUG71 - STATION 11

	DATA READ IN			ITERATED DATA	
	ANGLE (DEG)	SIGMA		ANGLE (DEG)	SIGMA
1				1.0000E-01	6.5329E 02
2	1.6900E-01	3.2400E 02	0	1.6900E-01	2.9035E 02
3	3.3800E-01	1.1100E 02	0	3.3800E-01	9.9472E 01
4	5.7300E-01	4.7500E 01	10	5.7300E-01	4.3225E 01
5	1.7200E 00	6.7000E 00	10	1.7200E 00	6.2941E 00
6	5.7300E 00	6.5000E-01	10	5.7300E 00	6.3242E-01
7	1.0000E 01	2.1800E-01	0	1.0000E 01	2.1554E-01
8	1.5000E 01	9.3500E-02	0	1.5000E 01	9.2828E-02
9	2.0000E 01	4.4500E-02	0	2.0000E 01	4.4268E-02
10	2.5000E 01	2.4000E-02	0	2.5000E 01	2.3900E-02
11	3.0000E 01	1.4500E-02	0	3.0000E 01	1.4450E-02
12	4.0000E 01	6.0300E-03	0	4.0000E 01	6.0140E-03
13	5.0000E 01	3.0000E-03	0	5.0000E 01	2.9934E-03
14	6.0000E 01	1.7400E-03	0	6.0000E 01	1.7366E-03
15	7.0000E 01	1.0960E-03	0	7.0000E 01	1.0940E-03
16	8.0000E 01	7.2500E-04	0	8.0000E 01	7.2376E-04
17	9.0000E 01	5.2500E-04	0	9.0000E 01	5.2412E-04
18	1.0000E 02	4.3700E-04	0	1.0000E 02	4.3626E-04
19	1.1000E 02	4.0800E-04	0	1.1000E 02	4.0727E-04
20	1.2000E 02	3.9800E-04	0	1.2000E 02	3.9723E-04
21	1.3000E 02	4.0800E-04	0	1.3000E 02	4.0710E-04
22	1.4000E 02	4.4700E-04	0	1.4000E 02	4.4582E-04
23	1.5000E 02	5.2500E-04	0	1.5000E 02	5.2319E-04
24	1.6000E 02	6.7000E-04	0	1.6000E 02	6.6651E-04
25	1.7000E 02	9.5000E-04	0	1.7000E 02	9.3927E-04
26				1.8000E 02	1.0302E-03

ITERATIONS= 4
 ITERATION CHANGE IN S/ALPHA LESS THAN 0.10 PERCENT

ALPHA= 0.398	S/ALPHA= 0.551
S= 0.219	A/ALPHA= 0.449
A= 0.179	B/S= 0.013

SIGMA(0.1 DEGREES)=	6.5329E 02	
SLOPE=	-1.545	
S UP TO 0.1 DEGREES=	2.7506E-02	NORMALIZED= 1.25411E-01

RATIO OF SIGMA(THETA) TO S				
THETA(DEG)	20.0	40.0	45.0	90.0
RATIO	2.0184E-01	2.7421E-02	1.8892E-02	2.3897E-03

	MU	RADIANS	DEGREES
MEDIAN	0.9990	0.4423E-01	2.534

HAOCE - 05AUG71 - STATION 11

ANGLE(RAD)	ANGLE(DEG)	SIGMA	INTEGRAL	NORM. INTEGRAL	
1.7453E-03	1.0000E-01	6.5329E 02	2.7506E-02	1.2541E-01	1
2.1972E-03	1.2589E-01	4.5768E 02	3.0541E-02	1.3925E-01	11
2.7662E-03	1.5849E-01	3.2064E 02	3.3911E-02	1.5461E-01	21
3.4824E-03	1.9953E-01	2.2517E 02	3.7657E-02	1.7169E-01	31
4.3841E-03	2.5119E-01	1.5788E 02	4.1824E-02	1.9069E-01	41
5.5192E-03	3.1623E-01	1.1038E 02	4.6449E-02	2.1178E-01	51
6.9483E-03	3.9811E-01	7.7309E 01	5.1575E-02	2.3515E-01	61
8.7474E-03	5.0119E-01	5.3705E 01	5.7248E-02	2.6102E-01	71
1.1012E-02	6.3096E-01	3.6749E 01	6.3454E-02	2.8931E-01	81
1.3864E-02	7.9433E-01	2.4805E 01	7.0127E-02	3.1974E-01	91
1.7453E-02	1.0000E 00	1.6623E 01	7.7241E-02	3.5217E-01	101
2.1972E-02	1.2589E 00	1.1060E 01	8.4769E-02	3.8650E-01	111
2.7662E-02	1.5849E 00	7.3058E 00	9.2677E-02	4.2256E-01	121
3.4824E-02	1.9953E 00	4.7505E 00	1.0090E-01	4.6006E-01	131
4.3841E-02	2.5119E 00	3.0669E 00	1.0933E-01	4.9849E-01	141
5.5192E-02	3.1623E 00	1.9772E 00	1.1795E-01	5.3778E-01	151
6.9483E-02	3.9811E 00	1.2728E 00	1.2675E-01	5.7789E-01	161
8.7473E-02	5.0119E 00	8.1825E-01	1.3571E-01	6.1877E-01	171
1.1012E-01	6.3096E 00	5.2847E-01	1.4485E-01	6.6042E-01	181
1.3864E-01	7.9433E 00	3.4020E-01	1.5420E-01	7.0307E-01	191
1.7453E-01	1.0000E 01	2.1554E-01	1.6365E-01	7.4617E-01	201
2.6180E-01	1.5000E 01	9.2828E-02	1.8032E-01	8.2214E-01	206
3.4907E-01	2.0000E 01	4.4268E-02	1.9081E-01	8.7000E-01	211
4.3633E-01	2.5000E 01	2.3900E-02	1.9759E-01	9.0089E-01	216
5.2360E-01	3.0000E 01	1.4450E-02	2.0229E-01	9.2233E-01	221
6.1086E-01	3.5000E 01	9.0629E-03	2.0565E-01	9.3767E-01	226
6.9813E-01	4.0000E 01	6.0140E-03	2.0812E-01	9.4889E-01	231
7.8540E-01	4.5000E 01	4.1435E-03	2.0996E-01	9.5730E-01	236
8.7266E-01	5.0000E 01	2.9934E-03	2.1138E-01	9.6379E-01	241
9.5993E-01	5.5000E 01	2.2525E-03	2.1251E-01	9.6893E-01	246
1.0472E 00	6.0000E 01	1.7366E-03	2.1343E-01	9.7310E-01	251
1.1345E 00	6.5000E 01	1.3689E-03	2.1418E-01	9.7652E-01	256
1.2217E 00	7.0000E 01	1.0940E-03	2.1480E-01	9.7934E-01	261
1.3090E 00	7.5000E 01	8.7821E-04	2.1531E-01	9.8168E-01	266
1.3963E 00	8.0000E 01	7.2376E-04	2.1573E-01	9.8362E-01	271
1.4835E 00	8.5000E 01	6.0355E-04	2.1609E-01	9.8526E-01	276
1.5708E 00	9.0000E 01	5.2412E-04	2.1640E-01	9.8666E-01	281
1.6581E 00	9.5000E 01	4.7034E-04	2.1667E-01	9.8789E-01	286
1.7453E 00	1.0000E 02	4.3626E-04	2.1692E-01	9.8901E-01	291
1.8326E 00	1.0500E 02	4.1890E-04	2.1714E-01	9.9006E-01	296
1.9199E 00	1.1000E 02	4.0727E-04	2.1736E-01	9.9104E-01	301
2.0071E 00	1.1500E 02	3.9941E-04	2.1756E-01	9.9197E-01	306
2.0944E 00	1.2000E 02	3.9723E-04	2.1776E-01	9.9285E-01	311
2.1817E 00	1.2500E 02	3.9841E-04	2.1794E-01	9.9369E-01	316
2.2689E 00	1.3000E 02	4.0710E-04	2.1812E-01	9.9449E-01	321
2.3562E 00	1.3500E 02	4.2193E-04	2.1828E-01	9.9525E-01	326
2.4435E 00	1.4000E 02	4.4582E-04	2.1844E-01	9.9598E-01	331
2.5307E 00	1.4500E 02	4.7749E-04	2.1860E-01	9.9668E-01	336
2.6180E 00	1.5000E 02	5.2319E-04	2.1874E-01	9.9735E-01	341
2.7053E 00	1.5500E 02	5.8236E-04	2.1888E-01	9.9798E-01	346
2.7925E 00	1.6000E 02	6.6651E-04	2.1901E-01	9.9858E-01	351
2.8798E 00	1.6500E 02	7.8226E-04	2.1913E-01	9.9912E-01	356
2.9671E 00	1.7000E 02	9.3927E-04	2.1923E-01	9.9958E-01	361
3.0543E 00	1.7500E 02	9.8473E-04	2.1930E-01	9.9989E-01	366
3.1416E 00	1.8000E 02	1.0302E-03	2.1933E-01	1.0000E 00	371

DATA READ IN				ITERATED DATA	
	ANGLE (DEG)	SIGMA		ANGLE (DEG)	SIGMA
1	8.5900E-02	7.1700E 03	0	8.5900E-02	3.2518E 03
2				1.0000E-01	2.6897E 03
3	1.6900E-01	3.0800E 03	0	1.6900E-01	1.3969E 03
4	3.3800E-01	1.2900E 03	0	3.3800E-01	5.8505E 02
5	5.7300E-01	5.6000E 02	10	5.7300E-01	2.8371E 02
6	1.7200E 00	7.7000E 01	10	1.7200E 00	4.9063E 01
7	5.7300E 00	6.2500E 00	10	5.7300E 00	5.1290E 00
8	1.0000E 01	1.8800E 00	0	1.0000E 01	1.7321E 00
9	1.5000E 01	8.1800E-01	0	1.5000E 01	7.7653E-01
10	2.0000E 01	4.0900E-01	0	2.0000E 01	3.9389E-01
11	2.5000E 01	2.5500E-01	0	2.5000E 01	2.4745E-01
12	3.0000E 01	1.4100E-01	0	3.0000E 01	1.3752E-01
13	4.0000E 01	7.0000E-02	0	4.0000E 01	6.8674E-02
14	5.0000E 01	3.7600E-02	0	5.0000E 01	3.7004E-02
15	6.0000E 01	2.1900E-02	0	6.0000E 01	2.1594E-02
16	7.0000E 01	1.4200E-02	0	7.0000E 01	1.4017E-02
17	8.0000E 01	9.8700E-03	0	8.0000E 01	9.7490E-03
18	9.0000E 01	7.3300E-03	0	9.0000E 01	7.2413E-03
19	1.0000E 02	5.7200E-03	0	1.0000E 02	5.6499E-03
20	1.1000E 02	4.8100E-03	0	1.1000E 02	4.7480E-03
21	1.2000E 02	4.4300E-03	0	1.2000E 02	4.3681E-03
22	1.3000E 02	4.2200E-03	0	1.3000E 02	4.1531E-03
23	1.4000E 02	3.9800E-03	0	1.4000E 02	3.9046E-03
24	1.5000E 02	4.2100E-03	0	1.5000E 02	4.1061E-03
25	1.6000E 02	4.8000E-03	0	1.6000E 02	4.6227E-03
26	1.7000E 02	6.3100E-03	0	1.7000E 02	5.8137E-03
27				1.8000E 02	6.2107E-03

ITERATIONS= 6
 ITERATION CHANGE IN S/ALPHA LESS THAN 0.10, PERCENT

ALPHA= 1.920	S/ALPHA= 0.824
S= 1.583	A/ALPHA= 0.176
A= 0.337	B/S= 0.019

SIGMA(0.1 DEGREES)=	2.6897E 03	
SLOPE=	-1.249	
S UP TO 0.1 DEGREES=	6.8519E-02	NORMALIZED= 4.32926E-02

RATIO OF SIGMA(THETA) TO S				
THETA(DEG)	20.0	40.0	45.0	90.0
RATIO	2.4888E-01	4.3390E-02	3.1484E-02	4.5753E-03

	MU	RADIANS	DEGREES
MEDIAN	0.9969	0.7849E-01	4.497

NUC - 04OCT71 - STATION 2200

ANGLE(RAD)	ANGLE(DEG)	SIGMA	INTEGRAL	NORM. INTEGRAL	
1.7453E-03	1.0000E-01	2.6897E 03	6.8519E-02	4.3293E-02	1
2.1972E-03	1.2589E-01	2.0184E 03	8.1463E-02	5.1471E-02	11
2.7662E-03	1.5849E-01	1.5137E 03	9.6853E-02	6.1195E-02	21
3.4824E-03	1.9953E-01	1.1434E 03	1.1520E-01	7.2787E-02	31
4.3841E-03	2.5119E-01	8.5880E 02	1.3713E-01	8.6645E-02	41
5.5192E-03	3.1623E-01	6.3858E 02	1.6311E-01	1.0306E-01	51
6.9483E-03	3.9811E-01	4.7132E 02	1.9359E-01	1.2232E-01	61
8.7474E-03	5.0119E-01	3.4338E 02	2.2904E-01	1.4472E-01	71
1.1012E-02	6.3096E-01	2.4613E 02	2.6965E-01	1.7038E-01	81
1.3864E-02	7.9433E-01	1.7368E 02	3.1539E-01	1.9928E-01	91
1.7453E-02	1.0000E 00	1.2098E 02	3.6621E-01	2.3138E-01	101
2.1972E-02	1.2589E 00	8.3195E 01	4.2194E-01	2.6660E-01	111
2.7662E-02	1.5849E 00	5.6477E 01	4.8229E-01	3.0473E-01	121
3.4824E-02	1.9953E 00	3.7376E 01	5.4651E-01	3.4531E-01	131
4.3841E-02	2.5119E 00	2.4419E 01	6.1325E-01	3.8747E-01	141
5.5192E-02	3.1623E 00	1.5884E 01	6.8220E-01	4.3104E-01	151
6.9483E-02	3.9811E 00	1.0287E 01	7.5310E-01	4.7584E-01	161
8.7473E-02	5.0119E 00	6.6334E 00	8.2569E-01	5.2170E-01	171
1.1012E-01	6.3096E 00	4.2564E 00	8.9966E-01	5.6844E-01	181
1.3864E-01	7.9433E 00	2.7197E 00	9.7464E-01	6.1581E-01	191
1.7453E-01	1.0000E 01	1.7321E 00	1.0503E 00	6.6364E-01	201
2.6180E-01	1.5000E 01	7.7653E-01	1.1863E 00	7.4956E-01	206
3.4907E-01	2.0000E 01	3.9389E-01	1.2757E 00	8.0605E-01	211
4.3633E-01	2.5000E 01	2.4745E-01	1.3421E 00	8.4797E-01	216
5.2360E-01	3.0000E 01	1.3752E-01	1.3884E 00	8.7725E-01	221
6.1086E-01	3.5000E 01	9.6166E-02	1.4220E 00	8.9848E-01	226
6.9813E-01	4.0000E 01	6.8674E-02	1.4494E 00	9.1577E-01	231
7.8540E-01	4.5000E 01	4.9829E-02	1.4708E 00	9.2929E-01	236
8.7266E-01	5.0000E 01	3.7004E-02	1.4884E 00	9.4042E-01	241
9.5993E-01	5.5000E 01	2.7820E-02	1.5021E 00	9.4906E-01	246
1.0472E 00	6.0000E 01	2.1594E-02	1.5136E 00	9.5637E-01	251
1.1345E 00	6.5000E 01	1.7224E-02	1.5228E 00	9.6213E-01	256
1.2217E 00	7.0000E 01	1.4017E-02	1.5309E 00	9.6726E-01	261
1.3090E 00	7.5000E 01	1.1579E-02	1.5373E 00	9.7131E-01	266
1.3963E 00	8.0000E 01	9.7490E-03	1.5432E 00	9.7506E-01	271
1.4835E 00	8.5000E 01	8.3435E-03	1.5479E 00	9.7800E-01	276
1.5708E 00	9.0000E 01	7.2413E-03	1.5524E 00	9.8084E-01	281
1.6581E 00	9.5000E 01	6.3288E-03	1.5558E 00	9.8303E-01	286
1.7453E 00	1.0000E 02	5.6499E-03	1.5593E 00	9.8524E-01	291
1.8326E 00	1.0500E 02	5.1132E-03	1.5619E 00	9.8689E-01	296
1.9199E 00	1.1000E 02	4.7480E-03	1.5648E 00	9.8867E-01	301
2.0071E 00	1.1500E 02	4.5331E-03	1.5669E 00	9.9000E-01	306
2.0944E 00	1.2000E 02	4.3681E-03	1.5693E 00	9.9152E-01	311
2.1817E 00	1.2500E 02	4.2661E-03	1.5710E 00	9.9263E-01	316
2.2689E 00	1.3000E 02	4.1531E-03	1.5731E 00	9.9394E-01	321
2.3562E 00	1.3500E 02	3.9648E-03	1.5745E 00	9.9482E-01	326
2.4435E 00	1.4000E 02	3.9046E-03	1.5762E 00	9.9590E-01	331
2.5307E 00	1.4500E 02	3.9665E-03	1.5772E 00	9.9656E-01	336
2.6180E 00	1.5000E 02	4.1061E-03	1.5787E 00	9.9747E-01	341
2.7053E 00	1.5500E 02	4.2909E-03	1.5795E 00	9.9798E-01	346
2.7925E 00	1.6000E 02	4.6227E-03	1.5807E 00	9.9873E-01	351
2.8798E 00	1.6500E 02	5.1195E-03	1.5812E 00	9.9908E-01	356
2.9671E 00	1.7000E 02	5.8137E-03	1.5821E 00	9.9964E-01	361
3.0543E 00	1.7500E 02	6.0122E-03	1.5823E 00	9.9975E-01	366
3.1416E 00	1.8000E 02	6.2107E-03	1.5827E 00	1.0000E 00	371

Figure 33

	DATA READ IN			ITERATED DATA	
	ANGLE (DEG)	SIGMA		ANGLE (DEG)	SIGMA
1	8.5900E-02	9.9700E 03	0	8.5900E-02	4.0024E 03
2				1.0000E-01	3.2620E 03
3	1.6900E-01	4.0100E 03	0	1.6900E-01	1.6098E 03
4	3.3800E-01	1.5400E 03	0	3.3800E-01	6.1823E 02
5	5.7300E-01	6.7500E 02	10	5.7300E-01	3.0791E 02
6	1.7200E 00	9.2000E 01	10	1.7200E 00	5.4684E 01
7	5.7300E 00	7.5000E 00	10	5.7300E 00	5.9699E 00
8	1.0000E 01	2.3200E 00	0	1.0000E 01	2.1107E 00
9	1.5000E 01	9.6000E-01	0	1.5000E 01	9.0405E-01
10	2.0000E 01	4.6500E-01	0	2.0000E 01	4.4523E-01
11	2.5000E 01	2.8300E-01	0	2.5000E 01	2.7335E-01
12	3.0000E 01	1.6600E-01	0	3.0000E 01	1.6128E-01
13	4.0000E 01	8.0900E-02	0	4.0000E 01	7.9133E-02
14	5.0000E 01	4.4700E-02	0	5.0000E 01	4.3884E-02
15	6.0000E 01	2.5900E-02	0	6.0000E 01	2.5483E-02
16	7.0000E 01	1.6800E-02	0	7.0000E 01	1.6550E-02
17	8.0000E 01	1.1400E-02	0	8.0000E 01	1.1239E-02
18	9.0000E 01	8.5300E-03	0	9.0000E 01	8.4110E-03
19	1.0000E 02	6.7900E-03	0	1.0000E 02	6.6940E-03
20	1.1000E 02	5.9800E-03	0	1.1000E 02	5.8912E-03
21	1.2000E 02	5.6400E-03	0	1.2000E 02	5.5491E-03
22	1.3000E 02	5.2500E-03	0	1.3000E 02	5.1541E-03
23	1.4000E 02	4.9300E-03	0	1.4000E 02	4.8223E-03
24	1.5000E 02	4.7700E-03	0	1.5000E 02	4.6344E-03
25	1.6000E 02	5.3700E-03	0	1.6000E 02	5.1417E-03
26	1.7000E 02	6.1000E-03	0	1.7000E 02	5.5497E-03
27				1.8000E 02	5.6857E-03

ITERATIONS= 7
 ITERATION CHANGE IN S/ALPHA LESS THAN 0.10 PERCENT

ALPHA= 2.190	S/ALPHA= 0.833
S= 1.824	A/ALPHA= 0.167
A= 0.366	B/S= 0.020

SIGMA(0.1 DEGREES)=	3.2620E 03	
SLOPE=	-1.346	
S UP TO 0.1 DEGREES=	9.5452E-02	NORMALIZED= 5.23221E-02

RATIO OF SIGMA(THETA) TO S				
THETA(DEG)	20.0	40.0	45.0	90.0
RATIO	2.4405E-01	4.3377E-02	3.2108E-02	4.6105E-03

	MU	RADIANS	DEGREES
MEDIAN	0.9967	0.8169E-01	4.680

NUC - 05OCT71 - STATION 2040

ANGLE(RAD)	ANGLE(DEG)	SIGMA	INTEGRAL	NORM. INTEGRAL	
1.7453E-03	1.0000E-01	3.2620E 03	9.5452E-02	5.2322E-02	1
2.1972E-03	1.2589E-01	2.3974E 03	1.1099E-01	6.0837E-02	11
2.7662E-03	1.5849E-01	1.7566E 03	1.2905E-01	7.0740E-02	21
3.4824E-03	1.9953E-01	1.2745E 03	1.4994E-01	8.2190E-02	31
4.3841E-03	2.5119E-01	9.2603E 02	1.7395E-01	9.5349E-02	41
5.5192E-03	3.1623E-01	6.7637E 02	2.0166E-01	1.1054E-01	51
6.9483E-03	3.9811E-01	5.0267E 02	2.3400E-01	1.2827E-01	61
8.7474E-03	5.0119E-01	3.7048E 02	2.7204E-01	1.4912E-01	71
1.1012E-02	6.3096E-01	2.6762E 02	3.1606E-01	1.7325E-01	81
1.3864E-02	7.9433E-01	1.8974E 02	3.6591E-01	2.0057E-01	91
1.7453E-02	1.0000E 00	1.3288E 02	4.2157E-01	2.3109E-01	101
2.1972E-02	1.2589E 00	9.1912E 01	4.8297E-01	2.6474E-01	111
2.7662E-02	1.5849E 00	6.2795E 01	5.4985E-01	3.0140E-01	121
3.4824E-02	1.9953E 00	4.1708E 01	6.2142E-01	3.4063E-01	131
4.3841E-02	2.5119E 00	2.7365E 01	6.9604E-01	3.8153E-01	141
5.5192E-02	3.1623E 00	1.7926E 01	7.7356E-01	4.2402E-01	151
6.9483E-02	3.9811E 00	1.1723E 01	8.5395E-01	4.6809E-01	161
8.7473E-02	5.0119E 00	7.6549E 00	9.3718E-01	5.1371E-01	171
1.1012E-01	6.3096E 00	5.0388E 00	1.0234E 00	5.6096E-01	181
1.3864E-01	7.9433E 00	3.3017E 00	1.1134E 00	6.1032E-01	191
1.7453E-01	1.0000E 01	2.1107E 00	1.2057E 00	6.6088E-01	201
2.6180E-01	1.5000E 01	9.0405E-01	1.3676E 00	7.4963E-01	206
3.4907E-01	2.0000E 01	4.4523E-01	1.4702E 00	8.0587E-01	211
4.3633E-01	2.5000E 01	2.7335E-01	1.5437E 00	8.4617E-01	216
5.2360E-01	3.0000E 01	1.6128E-01	1.5966E 00	8.7515E-01	221
6.1086E-01	3.5000E 01	1.1087E-01	1.6356E 00	8.9658E-01	226
6.9813E-01	4.0000E 01	7.9133E-02	1.6671E 00	9.1381E-01	231
7.8540E-01	4.5000E 01	5.8575E-02	1.6921E 00	9.2752E-01	236
8.7266E-01	5.0000E 01	4.3884E-02	1.7128E 00	9.3887E-01	241
9.5993E-01	5.5000E 01	3.2882E-02	1.7291E 00	9.4780E-01	246
1.0472E 00	6.0000E 01	2.5483E-02	1.7427E 00	9.5524E-01	251
1.1345E 00	6.5000E 01	2.0408E-02	1.7535E 00	9.6120E-01	256
1.2217E 00	7.0000E 01	1.6550E-02	1.7631E 00	9.6642E-01	261
1.3090E 00	7.5000E 01	1.3446E-02	1.7706E 00	9.7058E-01	266
1.3963E 00	8.0000E 01	1.1239E-02	1.7774E 00	9.7430E-01	271
1.4835E 00	8.5000E 01	9.6372E-03	1.7829E 00	9.7728E-01	276
1.5708E 00	9.0000E 01	8.4110E-03	1.7880E 00	9.8009E-01	281
1.6581E 00	9.5000E 01	7.3961E-03	1.7921E 00	9.8234E-01	286
1.7453E 00	1.0000E 02	6.6940E-03	1.7961E 00	9.8455E-01	291
1.8326E 00	1.0500E 02	6.2195E-03	1.7994E 00	9.8632E-01	296
1.9199E 00	1.1000E 02	5.8912E-03	1.8027E 00	9.8817E-01	301
2.0071E 00	1.1500E 02	5.7291E-03	1.8055E 00	9.8967E-01	306
2.0944E 00	1.2000E 02	5.5491E-03	1.8084E 00	9.9129E-01	311
2.1817E 00	1.2500E 02	5.3427E-03	1.8107E 00	9.9255E-01	316
2.2689E 00	1.3000E 02	5.1541E-03	1.8132E 00	9.9392E-01	321
2.3562E 00	1.3500E 02	4.9670E-03	1.8151E 00	9.9492E-01	326
2.4435E 00	1.4000E 02	4.8223E-03	1.8171E 00	9.9603E-01	331
2.5307E 00	1.4500E 02	4.6347E-03	1.8184E 00	9.9678E-01	336
2.6180E 00	1.5000E 02	4.6344E-03	1.8200E 00	9.9764E-01	341
2.7053E 00	1.5500E 02	4.8998E-03	1.8210E 00	9.9819E-01	346
2.7925E 00	1.6000E 02	5.1417E-03	1.8223E 00	9.9888E-01	351
2.8798E 00	1.6500E 02	5.3587E-03	1.8229E 00	9.9924E-01	356
2.9671E 00	1.7000E 02	5.5497E-03	1.8238E 00	9.9971E-01	361
3.0543E 00	1.7500E 02	5.6177E-03	1.8240E 00	9.9981E-01	366
3.1416E 00	1.8000E 02	5.6857E-03	1.8243E 00	1.0000E 00	371

	DATA READ IN			ITERATED DATA	
	ANGLE (DEG)	SIGMA		ANGLE (DEG)	SIGMA
1	8.5900E-02	5.0400E 03	0	8.5900E-02	2.7580E 03
2				1.0000E-01	2.2153E 03
3	1.6900E-01	1.9000E 03	0	1.6900E-01	1.0397E 03
4	3.3800E-01	7.2200E 02	0	3.3800E-01	3.9509E 02
5	5.7300E-01	3.1000E 02	10	5.7300E-01	1.8458E 02
6	1.7200E 00	4.8000E 01	10	1.7200E 00	3.4040E 01
7	5.7300E 00	5.0000E 00	10	5.7300E 00	4.3004E 00
8	1.0000E 01	1.5700E 00	0	1.0000E 01	1.4749E 00
9	1.5000E 01	6.1400E-01	0	1.5000E 01	5.9012E-01
10	2.0000E 01	3.0300E-01	0	2.0000E 01	2.9443E-01
11	2.5000E 01	1.7000E-01	0	2.5000E 01	1.6615E-01
12	3.0000E 01	1.0400E-01	0	3.0000E 01	1.0204E-01
13	4.0000E 01	4.9600E-02	0	4.0000E 01	4.8882E-02
14	5.0000E 01	2.6300E-02	0	5.0000E 01	2.5982E-02
15	6.0000E 01	1.5000E-02	0	6.0000E 01	1.4840E-02
16	7.0000E 01	9.7000E-03	0	7.0000E 01	9.6046E-03
17	8.0000E 01	6.7900E-03	0	8.0000E 01	6.7265E-03
18	9.0000E 01	4.9100E-03	0	9.0000E 01	4.8646E-03
19	1.0000E 02	4.0300E-03	0	1.0000E 02	3.9923E-03
20	1.1000E 02	3.4800E-03	0	1.1000E 02	3.4458E-03
21	1.2000E 02	3.2100E-03	0	1.2000E 02	3.1757E-03
22	1.3000E 02	2.9200E-03	0	1.3000E 02	2.8847E-03
23	1.4000E 02	2.8500E-03	0	1.4000E 02	2.8087E-03
24	1.5000E 02	3.0100E-03	0	1.5000E 02	2.9532E-03
25	1.6000E 02	3.4400E-03	0	1.6000E 02	3.3427E-03
26	1.7000E 02	3.7600E-03	0	1.7000E 02	3.5323E-03
27				1.8000E 02	3.5956E-03

ITERATIONS= 5
 ITERATION CHANGE IN S/ALPHA LESS THAN 0.10 PERCENT

ALPHA= 1.330 S/ALPHA= 0.906
 S= 1.205 A/ALPHA= 0.094
 A= 0.125 B/S= 0.018

w₀ = 0.906

SIGMA(0.1 DEGREES)= 2.2153E 03
 SLOPE= -1.442
 S UP TO 0.1 DEGREES= 7.5934E-02 NORMALIZED= 6.29990E-02

RATIO OF SIGMA(THETA) TO S

THETA(DEG)	20.0	40.0	45.0	90.0
RATIO	2.4427E-01	4.0555E-02	2.9265E-02	4.0360E-03

MEDIAN MU RADIANS DEGREES

0.9967 0.8172E-01 4.682

NUC - 05OCT71 - STATION 2240

ANGLE(RAD)	ANGLE(DEG)	SIGMA	INTEGRAL	NORM. INTEGRAL	
1.7453E-03	1.0000E-01	2.2153E 03	7.5934E-02	6.2999E-02	1
2.1972E-03	1.2589E-01	1.5855E 03	8.6335E-02	7.1629E-02	11
2.7662E-03	1.5849E-01	1.1393E 03	9.8157E-02	8.1437E-02	21
3.4824E-03	1.9953E-01	8.2732E 02	1.1169E-01	9.2661E-02	31
4.3841E-03	2.5119E-01	6.0058E 02	1.2727E-01	1.0559E-01	41
5.5192E-03	3.1623E-01	4.3425E 02	1.4517E-01	1.2044E-01	51
6.9483E-03	3.9811E-01	3.1314E 02	1.6565E-01	1.3743E-01	61
8.7474E-03	5.0119E-01	2.2458E 02	1.8899E-01	1.5680E-01	71
1.1012E-02	6.3096E-01	1.6037E 02	2.1546E-01	1.7876E-01	81
1.3864E-02	7.9433E-01	1.1393E 02	2.4535E-01	2.0356E-01	91
1.7453E-02	1.0000E 00	8.0269E 01	2.7887E-01	2.3137E-01	101
2.1972E-02	1.2589E 00	5.6082E 01	3.1613E-01	2.6228E-01	111
2.7662E-02	1.5849E 00	3.8858E 01	3.5722E-01	2.9637E-01	121
3.4824E-02	1.9953E 00	2.6852E 01	4.0224E-01	3.3372E-01	131
4.3841E-02	2.5119E 00	1.8401E 01	4.5138E-01	3.7449E-01	141
5.5192E-02	3.1623E 00	1.2457E 01	5.0443E-01	4.1850E-01	151
6.9483E-02	3.9811E 00	8.3305E 00	5.6097E-01	4.6541E-01	161
8.7473E-02	5.0119E 00	5.5035E 00	6.2052E-01	5.1482E-01	171
1.1012E-01	6.3096E 00	3.6296E 00	6.8259E-01	5.6632E-01	181
1.3864E-01	7.9433E 00	2.3572E 00	7.4723E-01	6.1995E-01	191
1.7453E-01	1.0000E 01	1.4749E 00	8.1244E-01	6.7405E-01	201
2.6180E-01	1.5000E 01	5.9012E-01	9.2093E-01	7.6405E-01	206
3.4907E-01	2.0000E 01	2.9443E-01	9.8904E-01	8.2056E-01	211
4.3633E-01	2.5000E 01	1.6615E-01	1.0352E 00	8.5887E-01	216
5.2360E-01	3.0000E 01	1.0204E-01	1.0680E 00	8.8606E-01	221
6.1086E-01	3.5000E 01	6.9550E-02	1.0928E 00	9.0661E-01	226
6.9813E-01	4.0000E 01	4.8882E-02	1.1122E 00	9.2275E-01	231
7.8540E-01	4.5000E 01	3.5274E-02	1.1276E 00	9.3550E-01	236
8.7266E-01	5.0000E 01	2.5982E-02	1.1398E 00	9.4566E-01	241
9.5993E-01	5.5000E 01	1.9268E-02	1.1495E 00	9.5372E-01	246
1.0472E 00	6.0000E 01	1.4840E-02	1.1573E 00	9.6020E-01	251
1.1345E 00	6.5000E 01	1.1801E-02	1.1638E 00	9.6553E-01	256
1.2217E 00	7.0000E 01	9.6046E-03	1.1692E 00	9.7001E-01	261
1.3090E 00	7.5000E 01	8.0020E-03	1.1737E 00	9.7380E-01	266
1.3963E 00	8.0000E 01	6.7265E-03	1.1777E 00	9.7707E-01	271
1.4835E 00	8.5000E 01	5.6162E-03	1.1810E 00	9.7983E-01	276
1.5708E 00	9.0000E 01	4.8646E-03	1.1839E 00	9.8220E-01	281
1.6581E 00	9.5000E 01	4.3754E-03	1.1864E 00	9.8429E-01	286
1.7453E 00	1.0000E 02	3.9923E-03	1.1887E 00	9.8618E-01	291
1.8326E 00	1.0500E 02	3.6746E-03	1.1907E 00	9.8787E-01	296
1.9199E 00	1.1000E 02	3.4458E-03	1.1926E 00	9.8942E-01	301
2.0071E 00	1.1500E 02	3.3149E-03	1.1943E 00	9.9084E-01	306
2.0944E 00	1.2000E 02	3.1757E-03	1.1959E 00	9.9215E-01	311
2.1817E 00	1.2500E 02	2.9975E-03	1.1973E 00	9.9333E-01	316
2.2689E 00	1.3000E 02	2.8847E-03	1.1986E 00	9.9439E-01	321
2.3562E 00	1.3500E 02	2.8162E-03	1.1997E 00	9.9534E-01	326
2.4435E 00	1.4000E 02	2.8087E-03	1.2007E 00	9.9621E-01	331
2.5307E 00	1.4500E 02	2.8509E-03	1.2017E 00	9.9699E-01	336
2.6180E 00	1.5000E 02	2.9532E-03	1.2025E 00	9.9770E-01	341
2.7053E 00	1.5500E 02	3.1716E-03	1.2033E 00	9.9834E-01	346
2.7925E 00	1.6000E 02	3.3427E-03	1.2040E 00	9.9891E-01	351
2.8798E 00	1.6500E 02	3.4632E-03	1.2046E 00	9.9937E-01	356
2.9671E 00	1.7000E 02	3.5323E-03	1.2050E 00	9.9972E-01	361
3.0543E 00	1.7500E 02	3.5640E-03	1.2052E 00	9.9992E-01	366
3.1416E 00	1.8000E 02	3.5956E-03	1.2053E 00	1.0000E 00	371

Figure 37

VISLAB - 15SEP71 - STATION (FILTERED FRESH WATER)

	DATA READ IN			ITERATED DATA	
	ANGLE (DEG)	SIGMA		ANGLE (DEG)	SIGMA
1				1.0000E-01	2.3282E 00
2	1.6900E-01	1.6900E 00	0	1.6900E-01	1.6820E 00
3	3.3800E-01	1.1000E 00	0	3.3800E-01	1.0948E 00
4	5.7300E-01	7.0000E-01	10	5.7300E-01	6.9716E-01
5	1.7200E 00	1.9000E-01	10	1.7200E 00	1.8949E-01
6	5.7300E 00	3.1000E-02	10	5.7300E 00	3.0964E-02
7	1.0000E 01	1.2300E-02	0	1.0000E 01	1.2294E-02
8	1.5000E 01	5.9300E-03	0	1.5000E 01	5.9282E-03
9	2.0000E 01	3.2500E-03	0	2.0000E 01	3.2493E-03
10	2.5000E 01	1.8400E-03	0	2.5000E 01	1.8397E-03
11	3.0000E 01	1.1500E-03	0	3.0000E 01	1.1498E-03
12	4.0000E 01	5.2500E-04	0	4.0000E 01	5.2494E-04
13	5.0000E 01	3.1300E-04	0	5.0000E 01	3.1297E-04
14	6.0000E 01	2.2400E-04	0	6.0000E 01	2.2398E-04
15	7.0000E 01	1.8300E-04	0	7.0000E 01	1.8299E-04
16	8.0000E 01	1.6100E-04	0	8.0000E 01	1.6099E-04
17	9.0000E 01	1.4700E-04	0	9.0000E 01	1.4699E-04
18	1.0000E 02	1.4400E-04	0	1.0000E 02	1.4399E-04
19	1.1000E 02	1.5400E-04	0	1.1000E 02	1.5399E-04
20	1.2000E 02	1.6600E-04	0	1.2000E 02	1.6599E-04
21	1.3000E 02	1.8400E-04	0	1.3000E 02	1.8398E-04
22	1.4000E 02	1.9700E-04	0	1.4000E 02	1.9698E-04
23	1.5000E 02	2.1600E-04	0	1.5000E 02	2.1597E-04
24	1.6000E 02	2.5800E-04	0	1.6000E 02	2.5794E-04
25	1.7000E 02	3.2400E-04	0	1.7000E 02	3.2384E-04
26				1.8000E 02	3.4581E-04

ITERATIONS= 3
 ITERATION CHANGE IN S/ALPHA LESS THAN 0.10 PERCENT

ALPHA=	0.102	S/ALPHA=	0.093
S=	0.009	A/ALPHA=	0.907
A=	0.093	B/S=	0.119

SIGMA(0.1 DEGREES)=	2.3282E 00	
SLOPE=	-0.620	
S UP TO 0.1 DEGREES=	3.2279E-05	NORMALIZED= 3.41860E-03

RATIO OF SIGMA(THETA) TO S				
THETA(DEG)	20.0	40.0	45.0	90.0
RATIO	3.4412E-01	5.5595E-02	4.1693E-02	1.5567E-02

	MU	RADIANS	DEGREES
MEDIAN	0.9757	0.2209	12.65

VISLAB - 15SEP71 - STATION (FILTERED FRESH WATER)

ANGLE(RAD)	ANGLE(DEG)	SIGMA	INTEGRAL	NORM. INTEGRAL	
1.7453E-03	1.0000E-01	2.3282E 00	3.2279E-05	3.4186E-03	1
2.1972E-03	1.2589E-01	2.0187E 00	4.4358E-05	4.6978E-03	11
2.7662E-03	1.5849E-01	1.7503E 00	6.0956E-05	6.4557E-03	21
3.4824E-03	1.9953E-01	1.5434E 00	8.3931E-05	8.8890E-03	31
4.3841E-03	2.5119E-01	1.3461E 00	1.1596E-04	1.2281E-02	41
5.5192E-03	3.1623E-01	1.1501E 00	1.5976E-04	1.6920E-02	51
6.9483E-03	3.9811E-01	9.6342E-01	2.1845E-04	2.3136E-02	61
8.7474E-03	5.0119E-01	7.9015E-01	2.9553E-04	3.1299E-02	71
1.1012E-02	6.3096E-01	6.3035E-01	3.9446E-04	4.1776E-02	81
1.3864E-02	7.9433E-01	4.9031E-01	5.1762E-04	5.4820E-02	91
1.7453E-02	1.0000E 00	3.7580E-01	6.6830E-04	7.0778E-02	101
2.1972E-02	1.2589E 00	2.8382E-01	8.4995E-04	9.0017E-02	111
2.7662E-02	1.5849E 00	2.1121E-01	1.0657E-03	1.1287E-01	121
3.4824E-02	1.9953E 00	1.5362E-01	1.3176E-03	1.3954E-01	131
4.3841E-02	2.5119E 00	1.1011E-01	1.6052E-03	1.7000E-01	141
5.5192E-02	3.1623E 00	7.8192E-02	1.9303E-03	2.0443E-01	151
6.9483E-02	3.9811E 00	5.5017E-02	2.2944E-03	2.4300E-01	161
8.7473E-02	5.0119E 00	3.8354E-02	2.6984E-03	2.8578E-01	171
1.1012E-01	6.3096E 00	2.6561E-02	3.1427E-03	3.3283E-01	181
1.3864E-01	7.9433E 00	1.8211E-02	3.6280E-03	3.8423E-01	191
1.7453E-01	1.0000E 01	1.2294E-02	4.1504E-03	4.3956E-01	201
2.6180E-01	1.5000E 01	5.9282E-03	5.1481E-03	5.4522E-01	206
3.4907E-01	2.0000E 01	3.2493E-03	5.8706E-03	6.2174E-01	211
4.3633E-01	2.5000E 01	1.8397E-03	6.3805E-03	6.7575E-01	216
5.2360E-01	3.0000E 01	1.1498E-03	6.7472E-03	7.1458E-01	221
6.1086E-01	3.5000E 01	7.4307E-04	7.0184E-03	7.4330E-01	226
6.9813E-01	4.0000E 01	5.2494E-04	7.2253E-03	7.6521E-01	231
7.8540E-01	4.5000E 01	3.9368E-04	7.3935E-03	7.8303E-01	236
8.7266E-01	5.0000E 01	3.1297E-04	7.5342E-03	7.9793E-01	241
9.5993E-01	5.5000E 01	2.5939E-04	7.6583E-03	8.1108E-01	246
1.0472E 00	6.0000E 01	2.2398E-04	7.7688E-03	8.2278E-01	251
1.1345E 00	6.5000E 01	2.0020E-04	7.8722E-03	8.3373E-01	256
1.2217E 00	7.0000E 01	1.8299E-04	7.9684E-03	8.4391E-01	261
1.3090E 00	7.5000E 01	1.7070E-04	8.0613E-03	8.5375E-01	266
1.3963E 00	8.0000E 01	1.6099E-04	8.1493E-03	8.6308E-01	271
1.4835E 00	8.5000E 01	1.5225E-04	8.2348E-03	8.7213E-01	276
1.5708E 00	9.0000E 01	1.4699E-04	8.3160E-03	8.8073E-01	281
1.6581E 00	9.5000E 01	1.4364E-04	8.3960E-03	8.8920E-01	286
1.7453E 00	1.0000E 02	1.4399E-04	8.4734E-03	8.9740E-01	291
1.8326E 00	1.0500E 02	1.4873E-04	8.5523E-03	9.0576E-01	296
1.9199E 00	1.1000E 02	1.5399E-04	8.6308E-03	9.1407E-01	301
2.0071E 00	1.1500E 02	1.5924E-04	8.7106E-03	9.2252E-01	306
2.0944E 00	1.2000E 02	1.6599E-04	8.7890E-03	9.3083E-01	311
2.1817E 00	1.2500E 02	1.7560E-04	8.8686E-03	9.3925E-01	316
2.2689E 00	1.3000E 02	1.8398E-04	8.9462E-03	9.4747E-01	321
2.3562E 00	1.3500E 02	1.8974E-04	9.0223E-03	9.5553E-01	326
2.4435E 00	1.4000E 02	1.9698E-04	9.0932E-03	9.6304E-01	331
2.5307E 00	1.4500E 02	2.0383E-04	9.1605E-03	9.7017E-01	336
2.6180E 00	1.5000E 02	2.1597E-04	9.2215E-03	9.7663E-01	341
2.7053E 00	1.5500E 02	2.3440E-04	9.2790E-03	9.8271E-01	346
2.7925E 00	1.6000E 02	2.5794E-04	9.3298E-03	9.8810E-01	351
2.8798E 00	1.6500E 02	2.8740E-04	9.3751E-03	9.9290E-01	356
2.9671E 00	1.7000E 02	3.2384E-04	9.4106E-03	9.9665E-01	361
3.0543E 00	1.7500E 02	3.3483E-04	9.4347E-03	9.9921E-01	366
3.1416E 00	1.8000E 02	3.4581E-04	9.4422E-03	1.0000E 00	371

Figure 39

VISLAB - 15SEP71 - STATION (FILTERED FRESH WATER+SCATTERING)

	DATA READ IN			ITERATED DATA		
	ANGLE (DEG)	SIGMA		ANGLE (DEG)	SIGMA	
1	8.5900E-02	2.5700E 02	0	8.5900E-02	1.9552E 02	
2				1.0000E-01	1.7935E 02	
3	1.6900E-01	1.7500E 02	0	1.6900E-01	1.3313E 02	
4	3.3800E-01	9.7300E 01	0	3.3800E-01	7.4022E 01	
5	5.7300E-01	5.6000E 01	10	5.7300E-01	4.4265E 01	
6	1.7200E 00	1.7000E 01	10	1.7200E 00	1.4547E 01	
7	5.7300E 00	3.0000E 00	10	5.7300E 00	2.8018E 00	
8	1.0000E 01	9.4400E-01	0	1.0000E 01	9.1763E-01	
9	1.5000E 01	3.3300E-01	0	1.5000E 01	3.2706E-01	
10	2.0000E 01	1.6700E-01	0	2.0000E 01	1.6484E-01	
11	2.5000E 01	8.7300E-02	0	2.5000E 01	8.6398E-02	
12	3.0000E 01	5.3000E-02	0	3.0000E 01	5.2544E-02	
13	4.0000E 01	2.1400E-02	0	4.0000E 01	2.1259E-02	
14	5.0000E 01	1.1400E-02	0	5.0000E 01	1.1337E-02	
15	6.0000E 01	6.1100E-03	0	6.0000E 01	6.0804E-03	
16	7.0000E 01	3.7800E-03	0	7.0000E 01	3.7631E-03	
17	8.0000E 01	2.4700E-03	0	8.0000E 01	2.4595E-03	
18	9.0000E 01	1.8300E-03	0	9.0000E 01	1.8223E-03	
19	1.0000E 02	1.5700E-03	0	1.0000E 02	1.5633E-03	
20	1.1000E 02	1.4200E-03	0	1.1000E 02	1.4136E-03	
21	1.2000E 02	1.4300E-03	0	1.2000E 02	1.4231E-03	
22	1.3000E 02	1.4500E-03	0	1.3000E 02	1.4420E-03	
23	1.4000E 02	1.5500E-03	0	1.4000E 02	1.5398E-03	
24	1.5000E 02	1.6800E-03	0	1.5000E 02	1.6656E-03	
25	1.6000E 02	1.7900E-03	0	1.6000E 02	1.7669E-03	
26	1.7000E 02	2.5100E-03	0	1.7000E 02	2.4399E-03	
27				1.8000E 02	2.6643E-03	

ITERATIONS= 4
 ITERATION CHANGE IN S/ALPHA LESS THAN 0.10 PERCENT

ALPHA= 0.685 S/ALPHA= 0.798
 S= 0.547 A/ALPHA= 0.202
 A= 0.138 B/S= 0.018

SIGMA(0.1 DEGREES)= 1.7935E 02
 SLOPE= -0.568
 S UP TO 0.1 DEGREES= 2.3969E-03 NORMALIZED= 4.38244E-03

RATIO OF SIGMA(THETA) TO S
 THETA(DEG) 20.0 40.0 45.0 90.0
 RATIO 3.0139E-01 3.8870E-02 2.8410E-02 3.3319E-03

MEDIAN MU RADIANS DEGREES
 0.9930 0.1185 6.790

VISLAB - 15SEP71 - STATION (FILTERED FRESH WATER+SCATTERING)

ANGLE(RAD)	ANGLE(DEC)	SIGMA	INTEGRAL	NORM. INTEGRAL	
1.7453E-03	1.0000E-01	1.7935E 02	2.3969E-03	4.3824E-03	1
2.1972E-03	1.2589E-01	1.5983E 02	3.3428E-03	6.1120E-03	11
2.7662E-03	1.5849E-01	1.3902E 02	4.6618E-03	8.5236E-03	21
3.4824E-03	1.9953E-01	1.1673E 02	6.4487E-03	1.1791E-02	31
4.3841E-03	2.5119E-01	9.6352E 01	8.8003E-03	1.6090E-02	41
5.5192E-03	3.1623E-01	7.8657E 01	1.1859E-02	2.1683E-02	51
6.9483E-03	3.9811E-01	6.3202E 01	1.5786E-02	2.8862E-02	61
8.7474E-03	5.0119E-01	5.0495E 01	2.0766E-02	3.7968E-02	71
1.1012E-02	6.3096E-01	4.0756E 01	2.7082E-02	4.9517E-02	81
1.3864E-02	7.9433E-01	3.3068E 01	3.5223E-02	6.4402E-02	91
1.7453E-02	1.0000E 00	2.6394E 01	4.5603E-02	8.3380E-02	101
2.1972E-02	1.2589E 00	2.0724E 01	5.8622E-02	1.0718E-01	111
2.7662E-02	1.5849E 00	1.6007E 01	7.4685E-02	1.3655E-01	121
3.4824E-02	1.9953E 00	1.2563E 01	9.4409E-02	1.7262E-01	131
4.3841E-02	2.5119E 00	9.6969E 00	1.1890E-01	2.1740E-01	141
5.5192E-02	3.1623E 00	7.2036E 00	1.4827E-01	2.7110E-01	151
6.9483E-02	3.9811E 00	5.1504E 00	1.8217E-01	3.3309E-01	161
8.7473E-02	5.0119E 00	3.5440E 00	2.1983E-01	4.0194E-01	171
1.1012E-01	6.3096E 00	2.3679E 00	2.6018E-01	4.7570E-01	181
1.3864E-01	7.9433E 00	1.5186E 00	3.0216E-01	5.5247E-01	191
1.7453E-01	1.0000E 01	9.1764E-01	3.4352E-01	6.2810E-01	201
2.6180E-01	1.5000E 01	3.2706E-01	4.0653E-01	7.4330E-01	206
3.4907E-01	2.0000E 01	1.6484E-01	4.4481E-01	8.1329E-01	211
4.3633E-01	2.5000E 01	8.6398E-02	4.6966E-01	8.5872E-01	216
5.2360E-01	3.0000E 01	5.2544E-02	4.8667E-01	8.8982E-01	221
6.1086E-01	3.5000E 01	3.1931E-02	4.9874E-01	9.1190E-01	226
6.9813E-01	4.0000E 01	2.1259E-02	5.0734E-01	9.2762E-01	231
7.8540E-01	4.5000E 01	1.5538E-02	5.1415E-01	9.4006E-01	236
8.7266E-01	5.0000E 01	1.1337E-02	5.1946E-01	9.4978E-01	241
9.5993E-01	5.5000E 01	8.1246E-03	5.2369E-01	9.5751E-01	246
1.0472E 00	6.0000E 01	6.0804E-03	5.2687E-01	9.6333E-01	251
1.1345E 00	6.5000E 01	4.7465E-03	5.2955E-01	9.6822E-01	256
1.2217E 00	7.0000E 01	3.7631E-03	5.3163E-01	9.7203E-01	261
1.3090E 00	7.5000E 01	2.9867E-03	5.3344E-01	9.7534E-01	266
1.3963E 00	8.0000E 01	2.4595E-03	5.3483E-01	9.7787E-01	271
1.4835E 00	8.5000E 01	2.0723E-03	5.3611E-01	9.8022E-01	276
1.5708E 00	9.0000E 01	1.8223E-03	5.3711E-01	9.8205E-01	281
1.6581E 00	9.5000E 01	1.6752E-03	5.3813E-01	9.8391E-01	286
1.7453E 00	1.0000E 02	1.5633E-03	5.3894E-01	9.8540E-01	291
1.8326E 00	1.0500E 02	1.4640E-03	5.3982E-01	9.8699E-01	296
1.9199E 00	1.1000E 02	1.4136E-03	5.4050E-01	9.8825E-01	301
2.0071E 00	1.1500E 02	1.4170E-03	5.4128E-01	9.8968E-01	306
2.0944E 00	1.2000E 02	1.4231E-03	5.4191E-01	9.9082E-01	311
2.1817E 00	1.2500E 02	1.4220E-03	5.4263E-01	9.9214E-01	316
2.2689E 00	1.3000E 02	1.4420E-03	5.4319E-01	9.9316E-01	321
2.3562E 00	1.3500E 02	1.4874E-03	5.4384E-01	9.9436E-01	326
2.4435E 00	1.4000E 02	1.5398E-03	5.4434E-01	9.9527E-01	331
2.5307E 00	1.4500E 02	1.6057E-03	5.4493E-01	9.9634E-01	336
2.6180E 00	1.5000E 02	1.6656E-03	5.4535E-01	9.9711E-01	341
2.7053E 00	1.5500E 02	1.6545E-03	5.4583E-01	9.9799E-01	346
2.7925E 00	1.6000E 02	1.7669E-03	5.4612E-01	9.9852E-01	351
2.8798E 00	1.6500E 02	2.0151E-03	5.4649E-01	9.9920E-01	356
2.9671E 00	1.7000E 02	2.4399E-03	5.4669E-01	9.9956E-01	361
3.0543E 00	1.7500E 02	2.5521E-03	5.4693E-01	1.0000E 00	366
3.1416E 00	1.8000E 02	2.6643E-03	5.4693E-01	1.0000E 00	371

Figure 41

VISLAB - 15SEP71 - STATION (FRESH WATER+SCATTERING+ABSORBING AGENTS)

	DATA READ IN			ITERATED DATA	
	ANGLE (DEG)	SIGMA		ANGLE (DEG)	SIGMA
1	8.5900E-02	2.9100E 02	0	8.5900E-02	2.1823E 02
2				1.0000E-01	1.9901E 02
3	1.6900E-01	1.9300E 02	0	1.6900E-01	1.4474E 02
4	3.3800E-01	1.0500E 02	0	3.3800E-01	7.8744E 01
5	5.7300E-01	6.0000E 01	10	5.7300E-01	4.6846E 01
6	1.7200E 00	1.8000E 01	10	1.7200E 00	1.5277E 01
7	5.7300E 00	3.2500E 00	10	5.7300E 00	3.0244E 00
8	1.0000E 01	9.8900E-01	0	1.0000E 01	9.5995E-01
9	1.5000E 01	3.6100E-01	0	1.5000E 01	3.5423E-01
10	2.0000E 01	1.7100E-01	0	2.0000E 01	1.6867E-01
11	2.5000E 01	8.6300E-02	0	2.5000E 01	8.5362E-02
12	3.0000E 01	5.2000E-02	0	3.0000E 01	5.1529E-02
13	4.0000E 01	2.2100E-02	0	4.0000E 01	2.1947E-02
14	5.0000E 01	1.1000E-02	0	5.0000E 01	1.0936E-02
15	6.0000E 01	5.8900E-03	0	6.0000E 01	5.8599E-03
16	7.0000E 01	3.4800E-03	0	7.0000E 01	3.4636E-03
17	8.0000E 01	2.4400E-03	0	8.0000E 01	2.4291E-03
18	9.0000E 01	1.9000E-03	0	9.0000E 01	1.8916E-03
19	1.0000E 02	1.5700E-03	0	1.0000E 02	1.5630E-03
20	1.1000E 02	1.4700E-03	0	1.1000E 02	1.4631E-03
21	1.2000E 02	1.4000E-03	0	1.2000E 02	1.3929E-03
22	1.3000E 02	1.4500E-03	0	1.3000E 02	1.4416E-03
23	1.4000E 02	1.4600E-03	0	1.4000E 02	1.4499E-03
24	1.5000E 02	1.5800E-03	0	1.5000E 02	1.5657E-03
25	1.6000E 02	1.7700E-03	0	1.6000E 02	1.7459E-03
26	1.7000E 02	2.2700E-03	0	1.7000E 02	2.2033E-03
27				1.8000E 02	2.3558E-03

ITERATIONS= 4
 ITERATION CHANGE IN S/ALPHA LESS THAN 0.10 PERCENT

ALPHA= 1.340	S/ALPHA= 0.430
S= 0.576	A/ALPHA= 0.570
A= 0.764	B/S= 0.017

SIGMA(0.1 DEGREES)=	1.9901E 02	
SLOPE=	-0.607	
S UP TO 0.1 DEGREES=	2.7340E-03	NORMALIZED= 4.74719E-03

RATIO OF SIGMA(THETA) TO S				
THETA(DEG)	20.0	40.0	45.0	90.0
RATIO	2.9288E-01	3.8107E-02	2.6628E-02	3.2845E-03

	MU	RADIANS	DEGREES
MEDIAN	0.9933	0.1155	6.616

VISLAB - 15SEP71 - STATION (FRESH WATER+SCATTERING+ABSORBING AGENTS)

ANGLE(RAD)	ANGLE(DEG)	SIGMA	INTEGRAL	NORM. INTEGRAL	
1.7453E-03	1.0000E-01	1.9901E 02	2.7340E-03	4.7472E-03	1
2.1972E-03	1.2589E-01	1.7569E 02	3.7784E-03	6.5606E-03	11
2.7662E-03	1.5849E-01	1.5148E 02	5.2216E-03	9.0664E-03	21
3.4824E-03	1.9953E-01	1.2605E 02	7.1595E-03	1.2431E-02	31
4.3841E-03	2.5119E-01	1.0324E 02	9.6883E-03	1.6822E-02	41
5.5192E-03	3.1623E-01	8.3788E 01	1.2955E-02	2.2495E-02	51
6.9483E-03	3.9811E-01	6.7119E 01	1.7130E-02	2.9744E-02	61
8.7474E-03	5.0119E-01	5.3505E 01	2.2413E-02	3.8916E-02	71
1.1012E-02	6.3096E-01	4.3049E 01	2.9097E-02	5.0522E-02	81
1.3864E-02	7.9433E-01	3.4803E 01	3.7679E-02	6.5423E-02	91
1.7453E-02	1.0000E 00	2.7716E 01	4.8589E-02	8.4367E-02	101
2.1972E-02	1.2589E 00	2.1743E 01	6.2252E-02	1.0809E-01	111
2.7662E-02	1.5849E 00	1.6803E 01	7.9107E-02	1.3736E-01	121
3.4824E-02	1.9953E 00	1.3332E 01	9.9897E-02	1.7346E-01	131
4.3841E-02	2.5119E 00	1.0417E 01	1.2606E-01	2.1889E-01	141
5.5192E-02	3.1623E 00	7.7971E 00	1.5775E-01	2.7391E-01	151
6.9483E-02	3.9811E 00	5.5899E 00	1.9451E-01	3.3774E-01	161
8.7473E-02	5.0119E 00	3.8386E 00	2.3536E-01	4.0867E-01	171
1.1012E-01	6.3096E 00	2.5257E 00	2.7884E-01	4.8416E-01	181
1.3864E-01	7.9433E 00	1.5916E 00	3.2317E-01	5.6114E-01	191
1.7453E-01	1.0000E 01	9.5996E-01	3.6643E-01	6.3625E-01	201
2.6180E-01	1.5000E 01	3.5423E-01	4.3420E-01	7.5393E-01	206
3.4907E-01	2.0000E 01	1.6867E-01	4.7450E-01	8.2390E-01	211
4.3633E-01	2.5000E 01	8.5362E-02	4.9943E-01	8.6719E-01	216
5.2360E-01	3.0000E 01	5.1529E-02	5.1614E-01	8.9620E-01	221
6.1086E-01	3.5000E 01	3.2819E-02	5.2829E-01	9.1729E-01	226
6.9813E-01	4.0000E 01	2.1947E-02	5.3719E-01	9.3274E-01	231
7.8540E-01	4.5000E 01	1.5336E-02	5.4403E-01	9.4463E-01	236
8.7266E-01	5.0000E 01	1.0936E-02	5.4922E-01	9.5364E-01	241
9.5993E-01	5.5000E 01	7.8903E-03	5.5331E-01	9.6074E-01	246
1.0472E 00	6.0000E 01	5.8599E-03	5.5641E-01	9.6612E-01	251
1.1345E 00	6.5000E 01	4.3910E-03	5.5892E-01	9.7047E-01	256
1.2217E 00	7.0000E 01	3.4636E-03	5.6084E-01	9.7381E-01	261
1.3090E 00	7.5000E 01	2.8563E-03	5.6253E-01	9.7674E-01	266
1.3963E 00	8.0000E 01	2.4291E-03	5.6389E-01	9.7910E-01	271
1.4835E 00	8.5000E 01	2.1254E-03	5.6517E-01	9.8133E-01	276
1.5708E 00	9.0000E 01	1.8916E-03	5.6622E-01	9.8315E-01	281
1.6581E 00	9.5000E 01	1.6888E-03	5.6724E-01	9.8493E-01	286
1.7453E 00	1.0000E 02	1.5630E-03	5.6808E-01	9.8638E-01	291
1.8326E 00	1.0500E 02	1.5086E-03	5.6894E-01	9.8788E-01	296
1.9199E 00	1.1000E 02	1.4631E-03	5.6967E-01	9.8915E-01	301
2.0071E 00	1.1500E 02	1.4108E-03	5.7045E-01	9.9049E-01	306
2.0944E 00	1.2000E 02	1.3929E-03	5.7108E-01	9.9159E-01	311
2.1817E 00	1.2500E 02	1.4227E-03	5.7178E-01	9.9281E-01	316
2.2689E 00	1.3000E 02	1.4416E-03	5.7235E-01	9.9380E-01	321
2.3562E 00	1.3500E 02	1.4315E-03	5.7298E-01	9.9489E-01	326
2.4435E 00	1.4000E 02	1.4499E-03	5.7347E-01	9.9573E-01	331
2.5307E 00	1.4500E 02	1.5000E-03	5.7401E-01	9.9667E-01	336
2.6180E 00	1.5000E 02	1.5657E-03	5.7441E-01	9.9737E-01	341
2.7053E 00	1.5500E 02	1.6255E-03	5.7486E-01	9.9815E-01	346
2.7925E 00	1.6000E 02	1.7459E-03	5.7516E-01	9.9868E-01	351
2.8798E 00	1.6500E 02	1.9340E-03	5.7551E-01	9.9929E-01	356
2.9671E 00	1.7000E 02	2.2033E-03	5.7571E-01	9.9963E-01	361
3.0543E 00	1.7500E 02	2.2796E-03	5.7592E-01	9.9999E-01	366
3.1416E 00	1.8000E 02	2.3558E-03	5.7592E-01	1.0000E 00	371

VISLAB-SEA WATER - 16SEP71 - STATION (AS DELIVERED)

	DATA READ IN			ITERATED DATA		
	ANGLE (DEG)	SIGMA		ANGLE (DEG)	SIGMA	
1	8.5900E-02	2.9300E 03	0	8.5900E-02	1.5414E 03	
2				1.0000E-01	1.3567E 03	
3	1.6900E-01	1.6600E 03	0	1.6900E-01	8.7328E 02	
4	3.3800E-01	8.1700E 02	0	3.3800E-01	4.2980E 02	
5	5.7300E-01	4.0000E 02	10	5.7300E-01	2.3023E 02	
6	1.7200E 00	6.9000E 01	10	1.7200E 00	4.7846E 01	
7	5.7300E 00	5.6000E 00	10	5.7300E 00	4.7692E 00	
8	1.0000E 01	1.5800E 00	0	1.0000E 01	1.4783E 00	
9	1.5000E 01	5.6000E-01	0	1.5000E 01	5.3683E-01	
10	2.0000E 01	3.0700E-01	0	2.0000E 01	2.9776E-01	
11	2.5000E 01	1.7000E-01	0	2.5000E 01	1.6590E-01	
12	3.0000E 01	1.0900E-01	0	3.0000E 01	1.0681E-01	
13	4.0000E 01	5.3700E-02	0	4.0000E 01	5.2872E-02	
14	5.0000E 01	2.6600E-02	0	5.0000E 01	2.6257E-02	
15	6.0000E 01	1.4500E-02	0	6.0000E 01	1.4335E-02	
16	7.0000E 01	9.0600E-03	0	7.0000E 01	8.9651E-03	
17	8.0000E 01	6.0500E-03	0	8.0000E 01	5.9897E-03	
18	9.0000E 01	4.5000E-03	0	9.0000E 01	4.4557E-03	
19	1.0000E 02	3.4000E-03	0	1.0000E 02	3.3661E-03	
20	1.1000E 02	3.0300E-03	0	1.1000E 02	2.9983E-03	
21	1.2000E 02	2.8600E-03	0	1.2000E 02	2.8275E-03	
22	1.3000E 02	2.7500E-03	0	1.3000E 02	2.7146E-03	
23	1.4000E 02	2.7500E-03	0	1.4000E 02	2.7076E-03	
24	1.5000E 02	2.7800E-03	0	1.5000E 02	2.7242E-03	
25	1.6000E 02	3.0700E-03	0	1.6000E 02	2.9776E-03	
26	1.7000E 02	3.5900E-03	0	1.7000E 02	3.3589E-03	
27				1.8000E 02	3.4860E-03	

ITERATIONS= 5
 ITERATION CHANGE IN S/ALPHA LESS THAN 0.10 PERCENT

ALPHA= 1.480	S/ALPHA= 0.867
S= 1.284	A/ALPHA= 0.133
A= 0.196	B/S= 0.015

SIGMA(0.1 DEGREES)=	1.3567E 03	
SLOPE=	-0.840	
S UP TO 0.1 DEGREES=	2.2379E-02	NORMALIZED= 1.74329E-02

RATIO OF SIGMA(THETA) TO S				
THETA(DEG)	20.0	40.0	45.0	90.0
RATIO	2.3195E-01	4.1187E-02	2.8625E-02	3.4710E-03

	MU	RADIANS	DEGREES
MEDIAN	0.9973	0.7356E-01	4.215

VISLAB-SEA WATER - 16SEP71 - STATION (AS DELIVERED)

ANGLE(RAD)	ANGLE(DEC)	SIGMA	INTEGRAL	NORM. INTEGRAL	
1.7453E-03	1.0000E-01	1.3567E 03	2.2379E-02	1.7433E-02	1
2.1972E-03	1.2589E-01	1.1297E 03	2.9279E-02	2.2808E-02	11
2.7662E-03	1.5849E-01	9.2576E 02	3.8309E-02	2.9842E-02	21
3.4824E-03	1.9953E-01	7.4537E 02	4.9931E-02	3.8896E-02	31
4.3841E-03	2.5119E-01	5.9130E 02	6.4644E-02	5.0357E-02	41
5.5192E-03	3.1623E-01	4.6261E 02	8.3009E-02	6.4663E-02	51
6.9483E-03	3.9811E-01	3.5737E 02	1.0563E-01	8.2284E-02	61
8.7474E-03	5.0119E-01	2.7190E 02	1.3312E-01	1.0370E-01	71
1.1012E-02	6.3096E-01	2.0475E 02	1.6603E-01	1.2934E-01	81
1.3864E-02	7.9433E-01	1.5226E 02	2.0514E-01	1.5981E-01	91
1.7453E-02	1.0000E 00	1.1072E 02	2.5072E-01	1.9531E-01	101
2.1972E-02	1.2589E 00	7.8724E 01	3.0264E-01	2.3575E-01	111
2.7662E-02	1.5849E 00	5.4735E 01	3.6048E-01	2.8081E-01	121
3.4824E-02	1.9953E 00	3.6606E 01	4.2315E-01	3.2963E-01	131
4.3841E-02	2.5119E 00	2.3941E 01	4.8858E-01	3.8060E-01	141
5.5192E-02	3.1623E 00	1.5482E 01	5.5601E-01	4.3313E-01	151
6.9483E-02	3.9811E 00	9.8994E 00	6.2472E-01	4.8665E-01	161
8.7473E-02	5.0119E 00	6.2589E 00	6.9393E-01	5.4056E-01	171
1.1012E-01	6.3096E 00	3.9659E 00	7.6306E-01	5.9441E-01	181
1.3864E-01	7.9433E 00	2.4746E 00	8.3232E-01	6.4837E-01	191
1.7453E-01	1.0000E 01	1.4783E 00	8.9926E-01	7.0051E-01	201
2.6180E-01	1.5000E 01	5.3683E-01	1.0005E 00	7.7940E-01	206
3.4907E-01	2.0000E 01	2.9776E-01	1.0665E 00	8.3078E-01	211
4.3633E-01	2.5000E 01	1.6590E-01	1.1127E 00	8.6678E-01	216
5.2360E-01	3.0000E 01	1.0681E-01	1.1461E 00	8.9282E-01	221
6.1086E-01	3.5000E 01	7.5352E-02	1.1727E 00	9.1353E-01	226
6.9813E-01	4.0000E 01	5.2872E-02	1.1937E 00	9.2988E-01	231
7.8540E-01	4.5000E 01	3.6746E-02	1.2101E 00	9.4268E-01	236
8.7266E-01	5.0000E 01	2.6257E-02	1.2226E 00	9.5238E-01	241
9.5993E-01	5.5000E 01	1.9007E-02	1.2324E 00	9.6003E-01	246
1.0472E 00	6.0000E 01	1.4335E-02	1.2399E 00	9.6588E-01	251
1.1345E 00	6.5000E 01	1.1229E-02	1.2462E 00	9.7077E-01	256
1.2217E 00	7.0000E 01	8.9651E-03	1.2512E 00	9.7464E-01	261
1.3090E 00	7.5000E 01	7.2135E-03	1.2555E 00	9.7800E-01	266
1.3963E 00	8.0000E 01	5.9897E-03	1.2589E 00	9.8064E-01	271
1.4835E 00	8.5000E 01	5.1556E-03	1.2620E 00	9.8309E-01	276
1.5708E 00	9.0000E 01	4.4557E-03	1.2645E 00	9.8504E-01	281
1.6581E 00	9.5000E 01	3.7821E-03	1.2669E 00	9.8688E-01	286
1.7453E 00	1.0000E 02	3.3661E-03	1.2687E 00	9.8830E-01	291
1.8326E 00	1.0500E 02	3.1512E-03	1.2705E 00	9.8974E-01	296
1.9199E 00	1.1000E 02	2.9983E-03	1.2720E 00	9.9090E-01	301
2.0071E 00	1.1500E 02	2.9044E-03	1.2736E 00	9.9215E-01	306
2.0944E 00	1.2000E 02	2.8275E-03	1.2749E 00	9.9315E-01	311
2.1817E 00	1.2500E 02	2.7557E-03	1.2763E 00	9.9424E-01	316
2.2689E 00	1.3000E 02	2.7146E-03	1.2774E 00	9.9508E-01	321
2.3562E 00	1.3500E 02	2.7078E-03	1.2786E 00	9.9602E-01	326
2.4435E 00	1.4000E 02	2.7076E-03	1.2795E 00	9.9671E-01	331
2.5307E 00	1.4500E 02	2.6850E-03	1.2805E 00	9.9750E-01	336
2.6180E 00	1.5000E 02	2.7242E-03	1.2812E 00	9.9803E-01	341
2.7053E 00	1.5500E 02	2.8357E-03	1.2820E 00	9.9867E-01	346
2.7925E 00	1.6000E 02	2.9776E-03	1.2825E 00	9.9905E-01	351
2.8798E 00	1.6500E 02	3.1512E-03	1.2831E 00	9.9954E-01	356
2.9671E 00	1.7000E 02	3.3589E-03	1.2834E 00	9.9975E-01	361
3.0543E 00	1.7500E 02	3.4224E-03	1.2837E 00	1.0000E 00	366
3.1416E 00	1.8000E 02	3.4860E-03	1.2837E 00	1.0000E 00	371

VISLAB-SEA WATER - 16SEP71 - STATION (FILTERED 40 MIN)

	DATA READ IN			ITERATED DATA	
	ANGLE (DEG)	SIGMA		ANGLE (DEG)	SIGMA
1				1.0000E-01	8.4335E 02
2	1.6900E-01	5.4000E 02	0	1.6900E-01	4.4053E 02
3	3.3800E-01	2.2900E 02	0	3.3800E-01	1.8682E 02
4	5.7300E-01	1.0000E 02	10	5.7300E-01	8.3938E 01
5	1.7200E 00	1.4000E 01	10	1.7200E 00	1.2466E 01
6	5.7300E 00	1.3500E 00	10	5.7300E 00	1.2830E 00
7	1.0000E 01	4.5200E-01	0	1.0000E 01	4.4257E-01
8	1.5000E 01	1.7300E-01	0	1.5000E 01	1.7070E-01
9	2.0000E 01	9.9300E-02	0	2.0000E 01	9.8342E-02
10	2.5000E 01	5.1400E-02	0	2.5000E 01	5.1004E-02
11	3.0000E 01	3.5400E-02	0	3.0000E 01	3.5173E-02
12	4.0000E 01	1.6100E-02	0	4.0000E 01	1.6021E-02
13	5.0000E 01	8.4100E-03	0	5.0000E 01	8.3755E-03
14	6.0000E 01	4.7400E-03	0	6.0000E 01	4.7229E-03
15	7.0000E 01	2.8600E-03	0	7.0000E 01	2.8505E-03
16	8.0000E 01	1.9100E-03	0	8.0000E 01	1.9039E-03
17	9.0000E 01	1.4600E-03	0	9.0000E 01	1.4554E-03
18	1.0000E 02	1.1900E-03	0	1.0000E 02	1.1862E-03
19	1.1000E 02	1.0800E-03	0	1.1000E 02	1.0764E-03
20	1.2000E 02	1.0100E-03	0	1.2000E 02	1.0063E-03
21	1.3000E 02	9.7700E-04	0	1.3000E 02	9.7299E-04
22	1.4000E 02	9.7700E-04	0	1.4000E 02	9.7220E-04
23	1.5000E 02	1.0100E-03	0	1.5000E 02	1.0035E-03
24	1.6000E 02	1.1700E-03	0	1.6000E 02	1.1587E-03
25	1.7000E 02	1.4800E-03	0	1.7000E 02	1.4491E-03
26				1.8000E 02	1.5459E-03

ITERATIONS= 4
 ITERATION CHANGE IN S/ALPHA LESS THAN 0.10 PERCENT

ALPHA= 0.595	S/ALPHA= 0.685
S= 0.407	A/ALPHA= 0.315
A= 0.188	B/S= 0.017

SIGMA(0.1 DEGREES)=	8.4335E 02	
SLOPE=	-1.238	
S UP TO 0.1 DEGREES=	2.1172E-02	NORMALIZED= 5.19796E-02

RATIO OF SIGMA(THETA) TO S				
THETA(DEG)	20.0	40.0	45.0	90.0
RATIO	2.4144E-01	3.9333E-02	2.8133E-02	3.5732E-03

	MU	RADIANS	DEGREES
MEDIAN	0.9979	0.6470E-01	3.707

VISLAB-SEA WATER - 16SEP71 - STATION (FILTERED 40 MIN)

ANGLE(RAD)	ANGLE(DEG)	SIGMA	INTEGRAL	NORM. INTEGRAL	
1.7453E-03	1.0000E-01	8.4335E 02	2.1172E-02	5.1980E-02	1
2.1972E-03	1.2589E-01	6.3423E 02	2.5235E-02	6.1954E-02	11
2.7662E-03	1.5849E-01	4.7696E 02	3.0078E-02	7.3843E-02	21
3.4824E-03	1.9953E-01	3.6592E 02	3.5897E-02	8.8132E-02	31
4.3841E-03	2.5119E-01	2.7708E 02	4.2954E-02	1.0546E-01	41
5.5192E-03	3.1623E-01	2.0480E 02	5.1319E-02	1.2599E-01	51
6.9483E-03	3.9811E-01	1.4695E 02	6.0974E-02	1.4970E-01	61
8.7474E-03	5.0119E-01	1.0356E 02	7.1840E-02	1.7637E-01	71
1.1012E-02	6.3096E-01	7.1478E 01	8.3871E-02	2.0591E-01	81
1.3864E-02	7.9433E-01	4.8441E 01	9.6878E-02	2.3784E-01	91
1.7453E-02	1.0000E 00	3.2596E 01	1.1080E-01	2.7202E-01	101
2.1972E-02	1.2589E 00	2.1778E 01	1.2559E-01	3.0834E-01	111
2.7662E-02	1.5849E 00	1.4448E 01	1.4120E-01	3.4665E-01	121
3.4824E-02	1.9953E 00	9.4353E 00	1.5750E-01	3.8667E-01	131
4.3841E-02	2.5119E 00	6.1185E 00	1.7428E-01	4.2787E-01	141
5.5192E-02	3.1623E 00	3.9624E 00	1.9151E-01	4.7018E-01	151
6.9483E-02	3.9811E 00	2.5628E 00	2.0918E-01	5.1356E-01	161
8.7473E-02	5.0119E 00	1.6553E 00	2.2728E-01	5.5798E-01	171
1.1012E-01	6.3096E 00	1.0890E 00	2.4586E-01	6.0361E-01	181
1.3864E-01	7.9433E 00	7.1120E-01	2.6533E-01	6.5140E-01	191
1.7453E-01	1.0000E 01	4.4257E-01	2.8497E-01	6.9962E-01	201
2.6180E-01	1.5000E 01	1.7070E-01	3.1620E-01	7.7631E-01	206
3.4907E-01	2.0000E 01	9.8342E-02	3.3783E-01	8.2940E-01	211
4.3633E-01	2.5000E 01	5.1004E-02	3.5240E-01	8.6517E-01	216
5.2360E-01	3.0000E 01	3.5173E-02	3.6307E-01	8.9138E-01	221
6.1086E-01	3.5000E 01	2.3240E-02	3.7156E-01	9.1222E-01	226
6.9813E-01	4.0000E 01	1.6021E-02	3.7791E-01	9.2781E-01	231
7.8540E-01	4.5000E 01	1.1459E-02	3.8301E-01	9.4033E-01	236
8.7266E-01	5.0000E 01	8.3755E-03	3.8689E-01	9.4985E-01	241
9.5993E-01	5.5000E 01	6.2284E-03	3.9011E-01	9.5776E-01	246
1.0472E 00	6.0000E 01	4.7229E-03	3.9254E-01	9.6372E-01	251
1.1345E 00	6.5000E 01	3.6147E-03	3.9463E-01	9.6885E-01	256
1.2217E 00	7.0000E 01	2.8505E-03	3.9617E-01	9.7264E-01	261
1.3090E 00	7.5000E 01	2.2838E-03	3.9758E-01	9.7611E-01	266
1.3963E 00	8.0000E 01	1.9039E-03	3.9862E-01	9.7864E-01	271
1.4835E 00	8.5000E 01	1.6494E-03	3.9966E-01	9.8120E-01	276
1.5708E 00	9.0000E 01	1.4554E-03	4.0043E-01	9.8308E-01	281
1.6581E 00	9.5000E 01	1.2938E-03	4.0126E-01	9.8513E-01	286
1.7453E 00	1.0000E 02	1.1862E-03	4.0185E-01	9.8657E-01	291
1.8326E 00	1.0500E 02	1.1252E-03	4.0255E-01	9.8829E-01	296
1.9199E 00	1.1000E 02	1.0764E-03	4.0304E-01	9.8950E-01	301
2.0071E 00	1.1500E 02	1.0359E-03	4.0366E-01	9.9102E-01	306
2.0944E 00	1.2000E 02	1.0063E-03	4.0407E-01	9.9203E-01	311
2.1817E 00	1.2500E 02	9.8499E-04	4.0461E-01	9.9336E-01	316
2.2689E 00	1.3000E 02	9.7299E-04	4.0496E-01	9.9420E-01	321
2.3562E 00	1.3500E 02	9.6821E-04	4.0543E-01	9.9537E-01	326
2.4435E 00	1.4000E 02	9.7220E-04	4.0571E-01	9.9605E-01	331
2.5307E 00	1.4500E 02	9.7257E-04	4.0611E-01	9.9704E-01	336
2.6180E 00	1.5000E 02	1.0035E-03	4.0632E-01	9.9755E-01	341
2.7053E 00	1.5500E 02	1.0665E-03	4.0666E-01	9.9840E-01	346
2.7925E 00	1.6000E 02	1.1587E-03	4.0681E-01	9.9877E-01	351
2.8798E 00	1.6500E 02	1.2842E-03	4.0710E-01	9.9946E-01	356
2.9671E 00	1.7000E 02	1.4491E-03	4.0717E-01	9.9965E-01	361
3.0543E 00	1.7500E 02	1.4975E-03	4.0736E-01	1.0001E 00	366
3.1416E 00	1.8000E 02	1.5459E-03	4.0732E-01	1.0000E 00	371

Figure 47

VISLAB - SEA WATER - 16SEP71 - STATION (FILTERED 1HR 40MIN)

	DATA READ IN			ITERATED DATA	
	ANGLE (DEG)	SIGMA		ANGLE (DEG)	SIGMA
1				1.0000E-01	1.8595E 02
2	1.6900E-01	9.6100E 01	0	1.6900E-01	9.2305E 01
3	3.3800E-01	3.8100E 01	0	3.3800E-01	3.6595E 01
4	5.7300E-01	1.6000E 01	10	5.7300E-01	1.5455E 01
5	1.7200E 00	2.5000E 00	10	1.7200E 00	2.4432E 00
6	5.7300E 00	2.5000E-01	10	5.7300E 00	2.4749E-01
7	1.0000E 01	7.5900E-02	0	1.0000E 01	7.5584E-02
8	1.5000E 01	3.3700E-02	0	1.5000E 01	3.3611E-02
9	2.0000E 01	1.9600E-02	0	2.0000E 01	1.9562E-02
10	2.5000E 01	1.0500E-02	0	2.5000E 01	1.0484E-02
11	3.0000E 01	6.7400E-03	0	3.0000E 01	6.7314E-03
12	4.0000E 01	2.8500E-03	0	4.0000E 01	2.8472E-03
13	5.0000E 01	1.5800E-03	0	5.0000E 01	1.5787E-03
14	6.0000E 01	9.0400E-04	0	6.0000E 01	9.0335E-04
15	7.0000E 01	5.8500E-04	0	7.0000E 01	5.8462E-04
16	8.0000E 01	4.1900E-04	0	8.0000E 01	4.1874E-04
17	9.0000E 01	3.3600E-04	0	9.0000E 01	3.3579E-04
18	1.0000E 02	2.9300E-04	0	1.0000E 02	2.9282E-04
19	1.1000E 02	2.8600E-04	0	1.1000E 02	2.8581E-04
20	1.2000E 02	2.9600E-04	0	1.2000E 02	2.9579E-04
21	1.3000E 02	3.0900E-04	0	1.3000E 02	3.0875E-04
22	1.4000E 02	3.2700E-04	0	1.4000E 02	3.2668E-04
23	1.5000E 02	3.6200E-04	0	1.5000E 02	3.6154E-04
24	1.6000E 02	4.0900E-04	0	1.6000E 02	4.0822E-04
25	1.7000E 02	5.0100E-04	0	1.7000E 02	4.9891E-04
26				1.8000E 02	5.2915E-04

ITERATIONS= 3
 ITERATION CHANGE IN S/ALPHA LESS THAN 0.10 PERCENT

ALPHA= 0.174 S/ALPHA= 0.463
 S= 0.081 A/ALPHA= 0.537
 A= 0.093 B/S= 0.025

SIGMA(0.1 DEGREES)= 1.8595E 02
 SLOPE= -1.335
 S UP TO 0.1 DEGREES= 5.3498E-03 NORMALIZED= 6.64135E-02

RATIO OF SIGMA(THETA) TO S

THETA(DEG)	20.0	40.0	45.0	90.0
RATIO	2.4285E-01	3.5346E-02	2.6225E-02	4.1686E-03

MEDIAN MU RADIANS DEGREES

	0.9982	0.6074E-01	3.480
--	--------	------------	-------

VISLAB - SEA WATER - 16SEP71 - STATION (FILTERED 1HR 40MIN)

ANGLE(RAD)	ANGLE(DEC)	SIGMA	INTEGRAL	NORM. INTEGRAL	
1.7453E-03	1.0000E-01	1.8595E 02	5.3498E-03	6.6414E-02	1
2.1972E-03	1.2589E-01	1.3675E 02	6.2354E-03	7.7407E-02	11
2.7662E-03	1.5849E-01	1.0056E 02	7.2676E-03	9.0221E-02	21
3.4824E-03	1.9953E-01	7.5554E 01	8.4813E-03	1.0529E-01	31
4.3841E-03	2.5119E-01	5.5973E 01	9.9223E-03	1.2318E-01	41
5.5192E-03	3.1623E-01	4.0406E 01	1.1592E-02	1.4390E-01	51
6.9483E-03	3.9811E-01	2.8058E 01	1.3467E-02	1.6718E-01	61
8.7474E-03	5.0119E-01	1.9261E 01	1.5512E-02	1.9257E-01	71
1.1012E-02	6.3096E-01	1.3272E 01	1.7737E-02	2.2019E-01	81
1.3864E-02	7.9433E-01	9.1563E 00	2.0175E-02	2.5046E-01	91
1.7453E-02	1.0000E 00	6.2518E 00	2.2827E-02	2.8337E-01	101
2.1972E-02	1.2589E 00	4.2248E 00	2.5681E-02	3.1880E-01	111
2.7662E-02	1.5849E 00	2.8256E 00	2.8722E-02	3.5655E-01	121
3.4824E-02	1.9953E 00	1.8797E 00	3.1933E-02	3.9643E-01	131
4.3841E-02	2.5119E 00	1.2375E 00	3.5305E-02	4.3829E-01	141
5.5192E-02	3.1623E 00	8.0363E-01	3.8799E-02	4.8166E-01	151
6.9483E-02	3.9811E 00	5.1479E-01	4.2369E-02	5.2598E-01	161
8.7473E-02	5.0119E 00	3.2527E-01	4.5968E-02	5.7065E-01	171
1.1012E-01	6.3096E 00	2.0036E-01	4.9536E-02	6.1494E-01	181
1.3864E-01	7.9433E 00	1.2217E-01	5.2978E-02	6.5768E-01	191
1.7453E-01	1.0000E 01	7.5585E-02	5.6325E-02	6.9922E-01	201
2.6180E-01	1.5000E 01	3.3611E-02	6.2119E-02	7.7116E-01	206
3.4907E-01	2.0000E 01	1.9562E-02	6.6388E-02	8.2416E-01	211
4.3633E-01	2.5000E 01	1.0484E-02	6.9361E-02	8.6105E-01	216
5.2360E-01	3.0000E 01	6.7314E-03	7.1480E-02	8.8737E-01	221
6.1086E-01	3.5000E 01	4.1858E-03	7.3048E-02	9.0683E-01	226
6.9813E-01	4.0000E 01	2.8472E-03	7.4184E-02	9.2093E-01	231
7.8540E-01	4.5000E 01	2.1125E-03	7.5104E-02	9.3235E-01	236
8.7266E-01	5.0000E 01	1.5787E-03	7.5831E-02	9.4138E-01	241
9.5993E-01	5.5000E 01	1.1722E-03	7.6434E-02	9.4886E-01	246
1.0472E 00	6.0000E 01	9.0335E-04	7.6897E-02	9.5461E-01	251
1.1345E 00	6.5000E 01	7.1586E-04	7.7299E-02	9.5960E-01	256
1.2217E 00	7.0000E 01	5.8462E-04	7.7615E-02	9.6352E-01	261
1.3090E 00	7.5000E 01	4.8661E-04	7.7905E-02	9.6712E-01	266
1.3963E 00	8.0000E 01	4.1874E-04	7.8134E-02	9.6997E-01	271
1.4835E 00	8.5000E 01	3.7044E-04	7.8359E-02	9.7277E-01	276
1.5708E 00	9.0000E 01	3.3579E-04	7.8541E-02	9.7502E-01	281
1.6581E 00	9.5000E 01	3.0851E-04	7.8728E-02	9.7734E-01	286
1.7453E 00	1.0000E 02	2.9282E-04	7.8879E-02	9.7922E-01	291
1.8326E 00	1.0500E 02	2.8688E-04	7.9046E-02	9.8129E-01	296
1.9199E 00	1.1000E 02	2.8581E-04	7.9184E-02	9.8300E-01	301
2.0071E 00	1.1500E 02	2.9040E-04	7.9341E-02	9.8496E-01	306
2.0944E 00	1.2000E 02	2.9579E-04	7.9472E-02	9.8658E-01	311
2.1817E 00	1.2500E 02	3.0162E-04	7.9622E-02	9.8844E-01	316
2.2689E 00	1.3000E 02	3.0875E-04	7.9743E-02	9.8994E-01	321
2.3562E 00	1.3500E 02	3.1561E-04	7.9880E-02	9.9165E-01	326
2.4435E 00	1.4000E 02	3.2668E-04	7.9988E-02	9.9298E-01	331
2.5307E 00	1.4500E 02	3.4271E-04	8.0111E-02	9.9451E-01	336
2.6180E 00	1.5000E 02	3.6154E-04	8.0203E-02	9.9565E-01	341
2.7053E 00	1.5500E 02	3.8001E-04	8.0308E-02	9.9695E-01	346
2.7925E 00	1.6000E 02	4.0822E-04	8.0379E-02	9.9783E-01	351
2.8798E 00	1.6500E 02	4.4727E-04	8.0460E-02	9.9885E-01	356
2.9671E 00	1.7000E 02	4.9891E-04	8.0505E-02	9.9940E-01	361
3.0543E 00	1.7500E 02	5.1403E-04	8.0552E-02	9.9999E-01	366
3.1416E 00	1.8000E 02	5.2915E-04	8.0553E-02	1.0000E 00	371

VISLAB-SEA WATER - 17SEP71 - STATION (FILTERED 18HR)

	DATA READ IN			ITERATED DATA	
	ANGLE (DEG)		SIGMA	ANGLE (DEG)	SIGMA
1				1.0000E-01	1.8806E 00
2	3.3800E-01		4.8000E-01	3.3800E-01	4.7797E-01
3	1.7200E 00		7.7000E-02	1.7200E 00	7.6815E-02
4	1.0000E 01		1.1100E-02	1.0000E 01	1.1095E-02
5	1.5000E 01		7.3800E-03	1.5000E 01	7.3780E-03
6	2.0000E 01		4.6400E-03	2.0000E 01	4.6391E-03
7	2.5000E 01		2.1900E-03	2.5000E 01	2.1897E-03
8	3.0000E 01		1.1300E-03	3.0000E 01	1.1299E-03
9	4.0000E 01		5.8200E-04	4.0000E 01	5.8194E-04
10	5.0000E 01		3.6300E-04	5.0000E 01	3.6297E-04
11	6.0000E 01		2.6100E-04	6.0000E 01	2.6098E-04
12	7.0000E 01		2.1000E-04	7.0000E 01	2.0999E-04
13	8.0000E 01		1.8900E-04	8.0000E 01	1.8899E-04
14	9.0000E 01		1.6500E-04	9.0000E 01	1.6499E-04
15	1.0000E 02		1.5900E-04	1.0000E 02	1.5899E-04
16	1.1000E 02		1.6500E-04	1.1000E 02	1.6499E-04
17	1.2000E 02		1.7600E-04	1.2000E 02	1.7599E-04
18	1.3000E 02		2.0200E-04	1.3000E 02	2.0198E-04
19	1.4000E 02		2.2600E-04	1.4000E 02	2.2598E-04
20	1.5000E 02		2.5100E-04	1.5000E 02	2.5097E-04
21	1.6000E 02		2.7000E-04	1.6000E 02	2.6995E-04
22	1.7000E 02		3.5100E-04	1.7000E 02	3.5085E-04
23				1.8000E 02	3.7781E-04

ITERATIONS= 3
 ITERATION CHANGE IN S/ALPHA LESS THAN 0.10 PERCENT

ALPHA= 0.093	S/ALPHA= 0.091
S= 0.008	A/ALPHA= 0.909
A= 0.085	B/S= 0.146

SIGMA(0.1 DEGREES)=	1.8806E 00	
SLOPE=	-1.125	
S UP TO 0.1 DEGREES=	4.1124E-05	NORMALIZED= 4.86290E-03

RATIO OF SIGMA(THETA) TO S				
THETA(DEG)	20.0	40.0	45.0	90.0
RATIO	5.4857E-01	6.8815E-02	5.3138E-02	1.9510E-02

MEDIAN	MU	RADIANS	DEGREES
	0.9453	0.3322	19.04

VISLAB-SEA WATER - 17SEP71 - STATION (FILTERED 18HR)

ANGLE(RAD)	ANGLE(DEG)	SIGMA	INTEGRAL	NORM. INTEGRAL	
1.7453E-03	1.0000E-01	1.8806E 00	4.1124E-05	4.8629E-03	1
2.1972E-03	1.2589E-01	1.4514E 00	5.0305E-05	5.9486E-03	11
2.7662E-03	1.5849E-01	1.1202E 00	6.1536E-05	7.2767E-03	21
3.4824E-03	1.9953E-01	8.6460E-01	7.5275E-05	8.9012E-03	31
4.3841E-03	2.5119E-01	6.6735E-01	9.2081E-05	1.0889E-02	41
5.5192E-03	3.1623E-01	5.1513E-01	1.1264E-04	1.3320E-02	51
6.9483E-03	3.9811E-01	3.9700E-01	1.3778E-04	1.6292E-02	61
8.7474E-03	5.0119E-01	3.0595E-01	1.6847E-04	1.9922E-02	71
1.1012E-02	6.3096E-01	2.3597E-01	2.0598E-04	2.4357E-02	81
1.3864E-02	7.9433E-01	1.8213E-01	2.5184E-04	2.9780E-02	91
1.7453E-02	1.0000E 00	1.4068E-01	3.0796E-04	3.6417E-02	101
2.1972E-02	1.2589E 00	1.0875E-01	3.7670E-04	4.4545E-02	111
2.7662E-02	1.5849E 00	8.4134E-02	4.6094E-04	5.4506E-02	121
3.4824E-02	1.9953E 00	6.4583E-02	5.6396E-04	6.6688E-02	131
4.3841E-02	2.5119E 00	4.9534E-02	6.8900E-04	8.1475E-02	141
5.5192E-02	3.1623E 00	3.8166E-02	8.4134E-04	9.9489E-02	151
6.9483E-02	3.9811E 00	2.9540E-02	1.0278E-03	1.2153E-01	161
8.7473E-02	5.0119E 00	2.2968E-02	1.2569E-03	1.4863E-01	171
1.1012E-01	6.3096E 00	1.7940E-02	1.5398E-03	1.8208E-01	181
1.3864E-01	7.9433E 00	1.4076E-02	1.8904E-03	2.2354E-01	191
1.7453E-01	1.0000E 01	1.1095E-02	2.3268E-03	2.7515E-01	201
2.6180E-01	1.5000E 01	7.3780E-03	3.4042E-03	4.0255E-01	206
3.4907E-01	2.0000E 01	4.6391E-03	4.4008E-03	5.2039E-01	211
4.3633E-01	2.5000E 01	2.1897E-03	5.0730E-03	5.9989E-01	216
5.2360E-01	3.0000E 01	1.1299E-03	5.4624E-03	6.4593E-01	221
6.1086E-01	3.5000E 01	7.8575E-04	5.7405E-03	6.7882E-01	226
6.9813E-01	4.0000E 01	5.8194E-04	5.9634E-03	7.0518E-01	231
7.8540E-01	4.5000E 01	4.4937E-04	6.1541E-03	7.2772E-01	236
8.7266E-01	5.0000E 01	3.6297E-04	6.3149E-03	7.4674E-01	241
9.5993E-01	5.5000E 01	3.0249E-04	6.4605E-03	7.6396E-01	246
1.0472E 00	6.0000E 01	2.6098E-04	6.5881E-03	7.7905E-01	251
1.1345E 00	6.5000E 01	2.3015E-04	6.7089E-03	7.9333E-01	256
1.2217E 00	7.0000E 01	2.0999E-04	6.8180E-03	8.0623E-01	261
1.3090E 00	7.5000E 01	2.0015E-04	6.9272E-03	8.1914E-01	266
1.3963E 00	8.0000E 01	1.8899E-04	7.0294E-03	8.3123E-01	271
1.4835E 00	8.5000E 01	1.7405E-04	7.1297E-03	8.4309E-01	276
1.5708E 00	9.0000E 01	1.6499E-04	7.2203E-03	8.5380E-01	281
1.6581E 00	9.5000E 01	1.6024E-04	7.3112E-03	8.6455E-01	286
1.7453E 00	1.0000E 02	1.5899E-04	7.3958E-03	8.7455E-01	291
1.8326E 00	1.0500E 02	1.6132E-04	7.4834E-03	8.8491E-01	296
1.9199E 00	1.1000E 02	1.6499E-04	7.5666E-03	8.9476E-01	301
2.0071E 00	1.1500E 02	1.6864E-04	7.6529E-03	9.0496E-01	306
2.0944E 00	1.2000E 02	1.7599E-04	7.7346E-03	9.1461E-01	311
2.1817E 00	1.2500E 02	1.8920E-04	7.8209E-03	9.2483E-01	316
2.2689E 00	1.3000E 02	2.0198E-04	7.9040E-03	9.3465E-01	321
2.3562E 00	1.3500E 02	2.1386E-04	7.9899E-03	9.4481E-01	326
2.4435E 00	1.4000E 02	2.2598E-04	8.0694E-03	9.5420E-01	331
2.5307E 00	1.4500E 02	2.3919E-04	8.1489E-03	9.6361E-01	336
2.6180E 00	1.5000E 02	2.5097E-04	8.2191E-03	9.7192E-01	341
2.7053E 00	1.5500E 02	2.5361E-04	8.2847E-03	9.7967E-01	346
2.7925E 00	1.6000E 02	2.6995E-04	8.3373E-03	9.8589E-01	351
2.8798E 00	1.6500E 02	3.0122E-04	8.3860E-03	9.9165E-01	356
2.9671E 00	1.7000E 02	3.5085E-04	8.4223E-03	9.9594E-01	361
3.0543E 00	1.7500E 02	3.6433E-04	8.4499E-03	9.9920E-01	366
3.1416E 00	1.8000E 02	3.7781E-04	8.4566E-03	1.0000E 00	371

Figure 51

7. DISCUSSION

The data presented involve eight sets of data for ocean water, a rather sparse sampling from which to draw conclusions applicable to all ocean waters. However, the data do span a wide range of water types from very clear to very turbid.

Reference to Fig. 10, which is a selected sampling of the volume scattering functions obtained for various water types, shows the functions to differ in absolute level by more than an order of magnitude but to be very similar in form. The curves show a slight indication that the low angle forward scattering in the clearest water does not rise, relatively, as rapidly as in the other waters and that the backward scattering for the very turbid waters, again relatively, does not rise as sharply as for the others.

The assumption that the slope of the function continues unchanged from the last data point to $\theta = 0^\circ$, when computing the volume scattering coefficient, s , is pure conjecture although there is no indication of any dramatic change in this area. If anything, the slope appears to be decreasing. From 3 to 15 percent of the total volume scattering obtained by integration lies below $\theta = 0.1^\circ$. Allowing the slope to go to zero when $\theta = 0^\circ$ with a parabolic fit would have affected the total s obtained very little. Omitting this part of the curve would have reduced the total s obtained by the 3 to 15 percent mentioned, the actual amount depending on the type of water. The probability curves show the importance of the low angle forward scattering. For the waters investigated, 18 to 28 percent of the total volume scattering coefficient is included in the area below 1.0° and 58 to 75 percent is included below 10° .

Under static conditions in the laboratory the low angle scattering meter has a repeatability of better than 1 percent. Under field conditions, time-varying changes in the water sample path cause small fluctuations in the output signal. Four readings were taken and averaged for each data point. The dark signal was recorded and the alignment tested before and after the instrument was used at each station. The data from the low angle measurements in the clearest water is the most susceptible to error. In very clear water the internal scattering and the dark signal of the low angle scattering meter are significant relative to the measurement. For this reason the scattering function for the lowest angle, $\theta = 0.086$ degrees, in clear water was not usable, and the data for 0.169 degrees in the clear water is possibly no better than

± 30 percent. With the exception just noted, ± 20 percent is a conservative estimate of the precision of the data obtained with the low angle scattering meter. The general angle scattering meter has a long history of good stability and reliability. It has a readout precision of ± 2 percent. Calibration errors and, again, noise caused by particle movement in the sample volume degrade the precision and an error band of ± 5 percent would be reasonable.

The two scattering instruments used give data from which the volume scattering function can be computed. The results are on an absolute basis, not relative, and cannot be greatly in error; otherwise, the results of the tests discussed in Section 4 would not have turned out so well.

The low angle scattering meter was designed for use in fairly clear waters. The sample path length was longer than desirable for use in the turbid waters and it was necessary to make corrections to the data as discussed in Section 3.2. When making measurements of the optical properties of water, the measurement path of the instrument used should be suited to the type of water being investigated, if possible.

ACKNOWLEDGMENTS

Many people contributed in different ways to the work which is summarized in this report. Particular credit must be given to several Visibility Laboratory staff members: R. W. Austin for his encouragement and insight; Wayne Wilson, who voluntarily worked many hours lending analytical assistance and performing all of the computer work; and Don Webb for his painstaking work and assistance in developing the optical systems used in the instruments. Special mention must also be made of Stevens P. Tucker, Naval Postgraduate School, Monterey, California, whose dedicated energy and oceanographic know-how overcame many obstacles and enabled the work at the Tongue of the Ocean to be accomplished.