



SEA-BIRD  
SCIENTIFIC

# User Manual

Release Date: 05/16/2016

**SBE** Sea-Bird  
Electronics

# SBE 17plus V2 Searam Recorder & Auto Fire Module

Memory & Auto Fire Module for SBE 9plus CTD



Manual version  
Firmware version  
Software versions

- 014
- 1.6 & later
- SeatermAF V2 2.1.4 & later
- SBE Data Processing 7.23.2 & later



Sea-Bird Electronics  
13431 NE 20th Street  
Bellevue, Washington  
98005 USA

Tel: +1 425-643-9866  
seabird@seabird.com  
www.seabird.com

## **Limited Liability Statement**

Extreme care should be exercised when using or servicing this equipment. It should be used or serviced only by personnel with knowledge of and training in the use and maintenance of oceanographic electronic equipment.

SEA-BIRD ELECTRONICS, INC. disclaims all product liability risks arising from the use or servicing of this system. SEA-BIRD ELECTRONICS, INC. has no way of controlling the use of this equipment or of choosing the personnel to operate it, and therefore cannot take steps to comply with laws pertaining to product liability, including laws which impose a duty to warn the user of any dangers involved in operating this equipment. Therefore, acceptance of this system by the customer shall be conclusively deemed to include a covenant by the customer to defend, indemnify, and hold SEA-BIRD ELECTRONICS, INC. harmless from all product liability claims arising from the use or servicing of this system.

# Declaration of Conformity

**Sea-Bird Electronics, Inc.**  
**13431 NE 20th Street Bellevue, WA 98005**

## DECLARATION OF CONFORMITY

**Manufacturer's Name:** Sea-Bird Electronics

**Manufacturer's Address:** 13431 NE 20th Street  
 Bellevue, WA 98005, USA

**Device Description:** Various Data Acquisition Devices and Sensors

**Model Numbers:**

3S	3F	3plus	4C	4M	5M	5T
5P	7	8	9plus	11plusV2	14	16plusV2
16plusIM-V2	17plusV2	18	19plusV2	21	25plus	26plus
27	29	32	32C	32SC	33	35
35RT	36/PDIM	37-SI	37-SIP	37-IM	37-IMP	37-SM
37-SMP	38	39	39-IM	39plus	41	41CP
43	43F	44	45	48	49	50
52-MP	53	54	55	56	63	PN 90204
PN 90158.1	PN 90488	PN 90545	PN 90402	AFM	SIM	ICC
IMM/UIMM	Glider Payload CTD	NIMH Battery Charger & Battery Pack (PN 90504)				

**Applicable EU Directives:** Machinery Directive 2006/42/EC

EMC Directive 2004/108/EC

Low Voltage Directive (2006/95/EC)

**Applicable Harmonized Standards:**

EN 61326-1:2013 Class A Electrical Equipment for Measurement, Control and Laboratory Use, EMC Requirement - Part 1: General Requirements (EN 55011:2009 Group 1, Class A)

EN 61010-1:2010, Safety Requirements for Electrical Equipments for Measurement, Control, and Laboratory Use - Part 1: General Requirements

I, the undersigned, hereby declare that the equipment specified above conforms to the above European Union Directives and Standards.

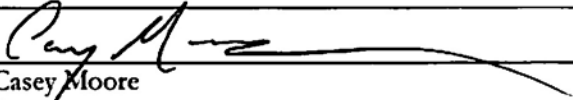
Authorized Signature:	
Name:	Casey Moore
Title of Signatory:	President
Date:	June 6, 2014
Place:	Bellevue, WA

# Table of Contents

<b>Limited Liability Statement</b> .....	<b>2</b>
<b>Declaration of Conformity</b> .....	<b>3</b>
<b>Table of Contents</b> .....	<b>4</b>
<b>Section 1: Introduction</b> .....	<b>6</b>
About this Manual .....	6
Quick Start .....	6
Unpacking Searam .....	7
<b>Section 2: Description of Searam</b> .....	<b>8</b>
System Description .....	8
Specifications.....	9
Dimensions .....	10
Electrical Connections .....	10
Cables and Wiring .....	11
Magnetic Reed Switch Plunger.....	13
Real-Time Clock.....	13
Memory.....	13
Data I/O .....	14
Batteries .....	14
<b>Section 3: Preparing Searam for Deployment</b> .....	<b>15</b>
Software Installation .....	15
Power and Communications Test .....	15
Setup .....	15
Test and Establish Operating Parameters.....	16
<b>Section 4: Deploying and Operating Searam</b> .....	<b>25</b>
Command Descriptions.....	25
Commands Not Typically Sent by User .....	32
Data Output Formats.....	34
Data Storage .....	34
Detailed Description of Data Formats .....	35
Frequency Limitations Imposed by Averaging.....	38
Testing SBE 32 Carousel Water Sampler Operation .....	39
Setup for Deployment.....	40
Deployment.....	41
Recovery .....	42
Physical Handling.....	42
Uploading Data.....	43
Processing Data Using SBE Data Processing .....	46
Verifying Contents of Configuration (.xmlcon or .con) File .....	47
Data Conversion .....	48
Bottle Summary .....	51
Other Processing Modules .....	51
Editing Raw Data File.....	52
<b>Section 5: Routine Maintenance</b> .....	<b>53</b>
Corrosion Precautions.....	53
Connector Mating and Maintenance .....	53
Replacing/Recharging Batteries.....	54
Recharging NiMH Batteries .....	54
Recharging Ni-Cad Batteries .....	56
Replacing Alkaline Batteries .....	57
O-Ring Maintenance.....	58

**Glossary .....59**

**Appendix I: Functional Description .....60**

**Appendix II: Electronics Disassembly/Reassembly .....61**

**Appendix III: Command Summary .....63**

**Appendix IV: Replacement Parts .....66**

**Appendix V: Manual Revision History .....70**

**Index.....72**

# Section 1: Introduction

This section includes a Quick Start procedure, and photos of a typical Searam shipment.

---

## About this Manual

This manual is to be used with the SBE 17*plus* V2 Searam. It is organized to guide the user from installation through operation and data collection. We have included detailed specifications, command descriptions, maintenance information, and helpful notes throughout the manual.

Sea-Bird welcomes suggestions for new features and enhancements of our products and/or documentation. Please contact us with any comments or suggestions (seabird@seabird.com or 425-643-9866). Our business hours are Monday through Friday, 0800 to 1700 Pacific Standard Time (1600 to 0100 Universal Time) in winter and 0800 to 1700 Pacific Daylight Time (1500 to 0000 Universal Time) the rest of the year.

---

## Quick Start

Follow these steps to get a Quick Start using the Searam. The manual provides step-by-step details for performing each task:

1. Install Searam and SBE 9*plus* CTD on SBE 32 Carousel Water Sampler.
2. Perform pre-check procedures:
  - A. Test Power and Communications (see *Power and Communications Test* in *Section 3: Preparing Searam for Deployment*).
3. Deploy the Searam:
  - A. Set the time and date, set memory and auto fire parameters, and program and arm the auto fire (see *Setup for Deployment* and *Command Descriptions* in *Section 4: Deploying and Operating Searam*).
  - B. Replace the I/O cable with the dummy plug and locking sleeve, and verify all other cables and hardware are secure (see *Deployment* in *Section 4: Deploying and Operating Searam*).
  - C. Deploy the system.

# Unpacking Searam

Shown below is a typical Searam shipment.



SBE 17plus V2 Searam



Data I/O cable  
(connection to computer serial port)



9plus / Searam cable  
(connection to SBE 9plus)



4-pin dummy plug  
& locking sleeve



Carousel/Searam cable  
(optional, connection to  
SBE 32 Carousel Water Sampler)



6-pin dummy plug  
& locking sleeve  
(2 of each)



Spare magnetic  
switch plunger



Jackscrew Kit



NiMH battery charger, battery pack, battery  
charger cable, & AC power cable



Spare fuses (2) for  
NiMH battery charger –  
stored in compartment  
inside charger



Spare o-ring &  
hardware kit



Spare battery end  
cap o-ring &  
hardware kit

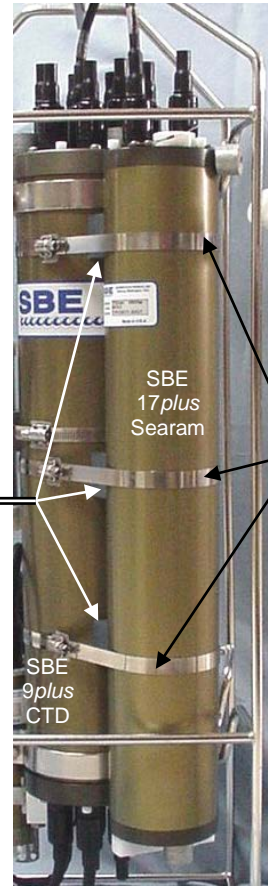

Mounting  
blocks (3)  
in  
Mounting  
Kit

SBE  
17plus  
Searam

Hose clamps (3)  
in Mounting Kit

SBE  
9plus  
CTD

Mounting Kit (shown installed on Searam); kit also  
includes Teflon tape for preventing contact of  
stainless steel clamps to aluminum housing



Software, & electronic  
copies of software  
manuals & user manual

# Section 2: Description of Searam

This section describes the functions and features of the SBE 17plus V2 Searam, including specifications and dimensions.

## System Description

### Notes:

- When the 9plus CTD is used with the 17plus V2 Searam, the system is often referred to as the **917plus**.
- It is possible to use the Searam to record 9plus data in memory at the same time as 9plus data is transmitted real-time through the 11plus V2 Deck Unit. This provides a data back-up in case there are data transmission problems over the sea cable. See the 9plus manual for wiring and deployment details.



### Notes:

- The term *Carousel* or *SBE 32 Carousel* applies to both SBE 32 (full size) and 32C (compact) models.
- Winch and cable are not supplied by Sea-Bird.
- When used without a Carousel, the 9plus is deployed in a vertical orientation.
- Sensors for the 9plus are not shown.
- A 9plus with the serial data uplink feature cannot be used with the Searam.

### Note:

Nickel-Cadmium battery pack and charger are no longer available.

The SBE 9plus CTD is used with the SBE 11plus V2 Deck Unit for real-time data acquisition, or with the SBE 17plus V2 Searam for in-situ recording. **This manual covers the use of the 17plus V2 Searam with the 9plus.**

The SBE 17plus V2 Searam is an *in-situ* battery pack and data recorder for use with the **SBE 9plus CTD** underwater unit when an electrical cable and slip ring equipped winch is not available. The Searam supplies power to the SBE 9plus. The serial data stream from the SBE 9plus is decoded and optionally averaged by the Searam, allowing the user to trade memory duration for CTD resolution. Unused channels are stripped out, further increasing memory duration, and the resulting data is stored in non-volatile memory in the Searam for later retrieval and analysis.

The Searam also powers and operates the **SBE 32 Carousel Water Sampler** to close water sample bottles on upcast. Using the pressure data from the SBE 9plus and a user-input table of bottle closure pressures, the Searam signals the SBE 32 to close a bottle. Built-in logic and user-input parameters provide control in determining when the upcast begins, preventing accidental bottle closure caused by temporary upward movements during the downcast. A bottle confirm bit is set in the 9plus data stream stored in the Searam to mark scans associated with each bottle closure. The Searam can close up to 24 bottles.

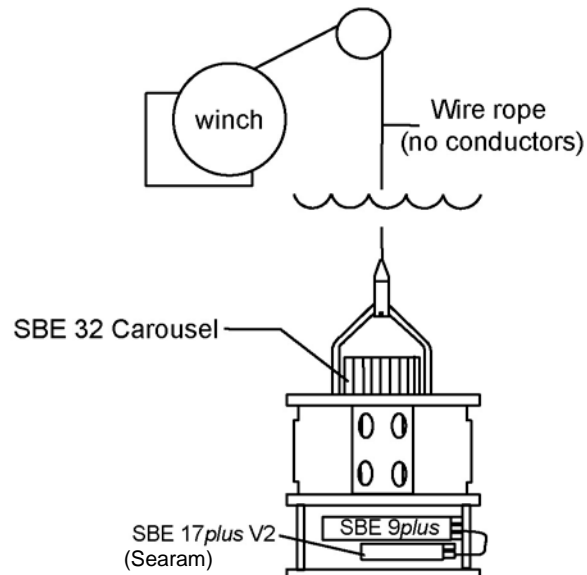

The Searam is mounted parallel to the SBE 9plus main housing. Rechargeable Nickel Metal Hydride (included), Nickel-Cadmium, or alkaline batteries provide power. The Searam's non-volatile memory preserves recorded data in the event of failure or exhaustion of the main battery pack. A low power *watch* crystal is used as the real-time-clock frequency source. An external magnetic reed switch plunger allows recording to be started and stopped without hooking up a terminal or computer to the Searam.



The Searam includes:

- 16M byte of non-volatile FLASH RAM, providing memory endurance of over 6 hours at the full data rate of 24 Hz with all channels stored
- Aluminum housing for depths to 6800 meters (22,300 feet), or titanium housing for use to 7000 or 10500 meters (23,000 or 34,400 feet)
- XSG / AG connectors or wet-pluggable MCBH connectors
- Mounting kit
- Nickel Metal Hydride (NiMH) rechargeable batteries in a removable battery pack, and battery charger and associated cables
- Short jumper cable (6-pin to 6-pin) for connection to the SBE 9plus Searam/modem bulkhead connector
- 20 meter data I/O cable for connection to the computer for setup and data upload

**Notes:**

- Help files provide detailed information on the software.
- A separate software manual on CD-ROM contains detailed information on SBE Data Processing.
- Sea-Bird supplies the current version of our software when you purchase an instrument. As software revisions occur, we post the revised software on our website. See our website for the latest software version number, a description of the software changes, and instructions for downloading the software.

Optional accessories include:

- AC-powered junction box for supplying external power to the Searam for testing
- Cable (6-pin to 6-pin) for connection to the SBE 32 Carousel Water Sampler 6-pin connector

The Searam is supplied with a powerful Windows software package, Seasoft V2, which includes:

- **SeatermAF V2** - terminal program for easy communication and data retrieval; referred to as SeatermAF for brevity.
- **SBE Data Processing** - program for calculation, display, and plotting of temperature, conductivity, pressure, auxiliary sensor data, and derived variables such as salinity and sound velocity.

## Specifications

**CAUTION:**

The Searam has no clamp or voltage drop circuitry to limit the supply voltage to the SBE 9plus. Thus, the voltage supplied by the Searam's power supply is the voltage supplied to the 9plus, which is also the voltage supplied by the 9plus to all its auxiliary sensors. Some auxiliary voltage sensors, such as WET Labs ECO sensors, are limited to input voltages less than 15 volts. Twelve fully charged batteries in the Searam supply the following voltage:

- NiMH or Ni-Cad - 14.4 volts
- **Alkaline - 18 volts**

**Using alkaline batteries in the Searam for 9plus deployments including lower input voltage sensors can damage the sensors.**

<b>Memory</b>	16M byte non-volatile FLASH RAM
<b>Real-Time Clock</b>	Watch-crystal type 32,768 Hz
<b>Internal Batteries</b>	12 rechargeable, Nickel Metal Hydride (NiMH), D-cell batteries, nominal 8 Amp-hours capacity. Provides sufficient energy to power a 9plus (without auxiliary sensors) for 10 hours, 9plus with auxiliary sensors for 7 hours.  <i>Notes:</i> 1. You can use 12 alkaline D-cells or Sea-Bird's Ni-Cad battery pack in place of NiMH batteries (Ni-Cad battery pack and charger no longer available). 2. Searam battery packs for NiMH, Ni-Cad, and alkaline batteries differ – you cannot put alkalines in NiMH or Ni-Cad battery pack or vice versa.
<b>Housing Materials</b>	7075-T6 anodized aluminum pressure case rated at 6800 m (22,300 ft), with zinc anode protection.  Titanium pressure case rated at 7000 or 10500 m (22,900 or 34,400 feet)
<b>Communication Interface</b>	3-wire RS-232C link, factory-configured for 9600 baud, 8 data bits, 1 stop bit, and no parity
<b>Carousel Compatibility</b>	Can close up to 24 bottles. If using with 36-bottle Carousel, can only close 24 bottles.
<b>Weight</b>	With aluminum housing: In water: 4.5 kg (10 lbs); In air: 9.0 kg (20 lbs)



# Cables and Wiring

**Searam cable –**  
Connects 17plus to JT7 bulkhead connector on SBE 9plus. Also connects 17plus to JB2 bulkhead connector on SBE 32 Carousel.

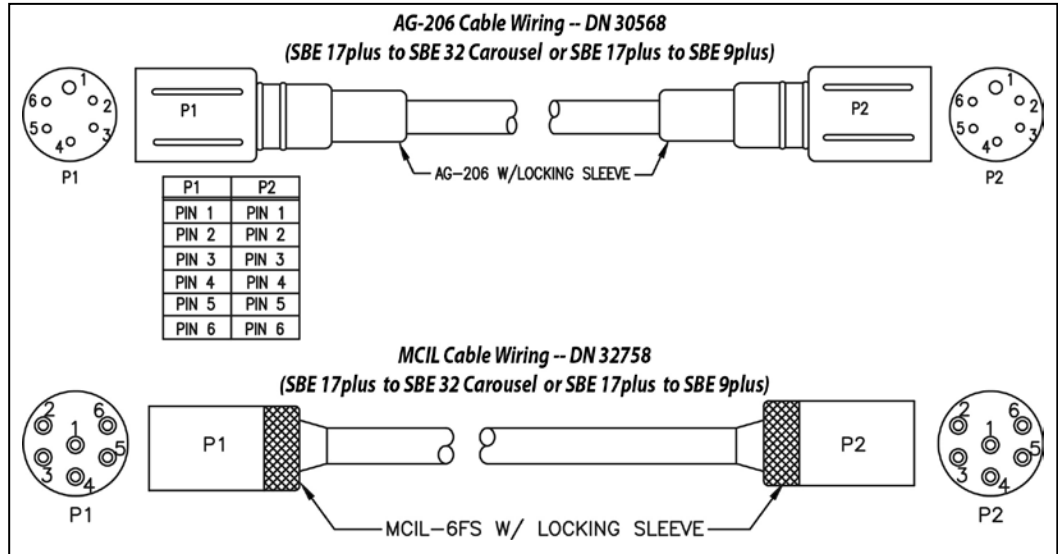

**Data I/O cable –**  
Connects 17plus to computer for setup and data upload.

- DN 31222 and 32789 are shielded.
- DN 32421 and 32715 are unshielded; typically for short cables for bench use.

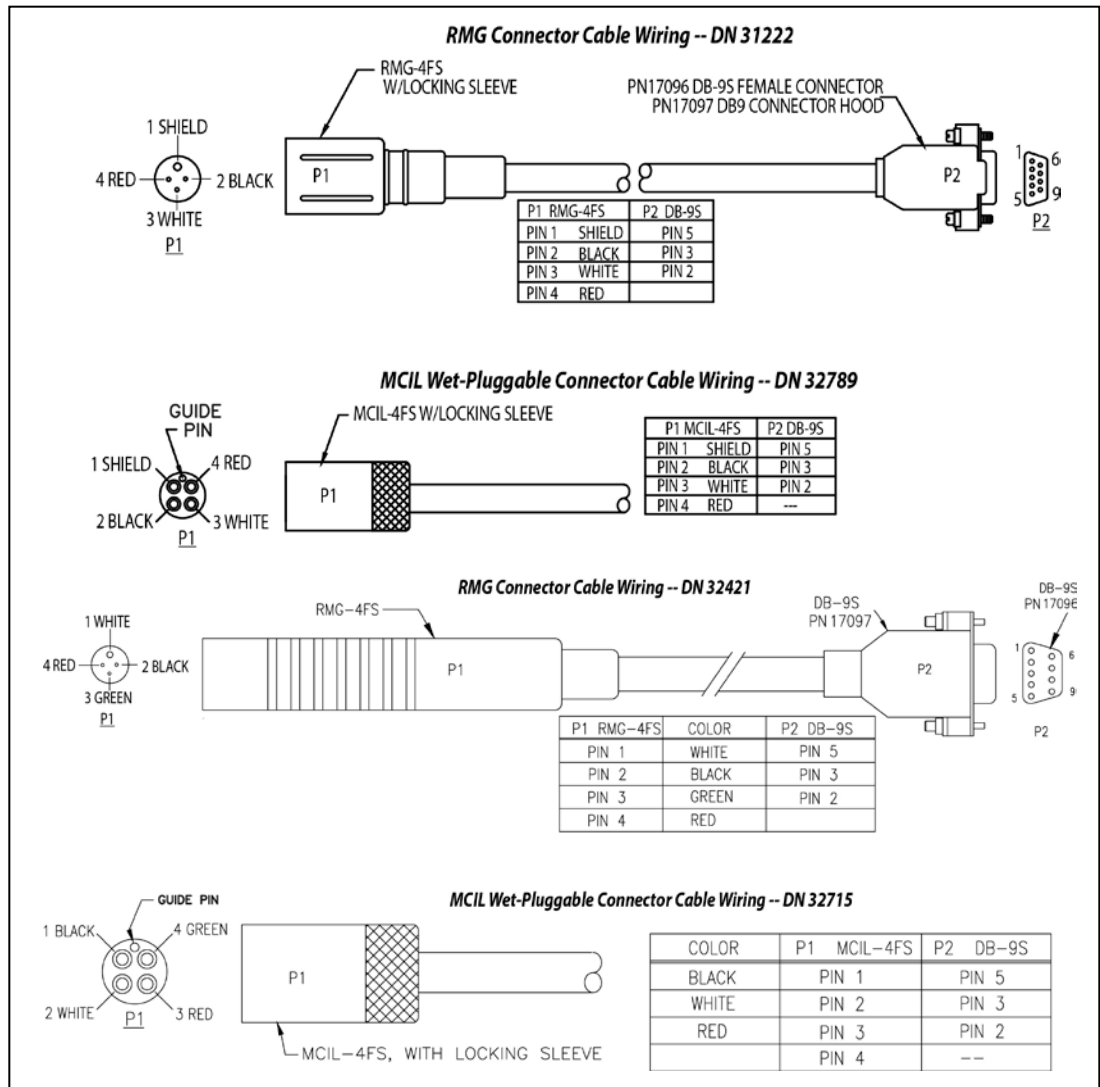

Internal wiring

**XSG / AG end cap connectors -- DN 32313**

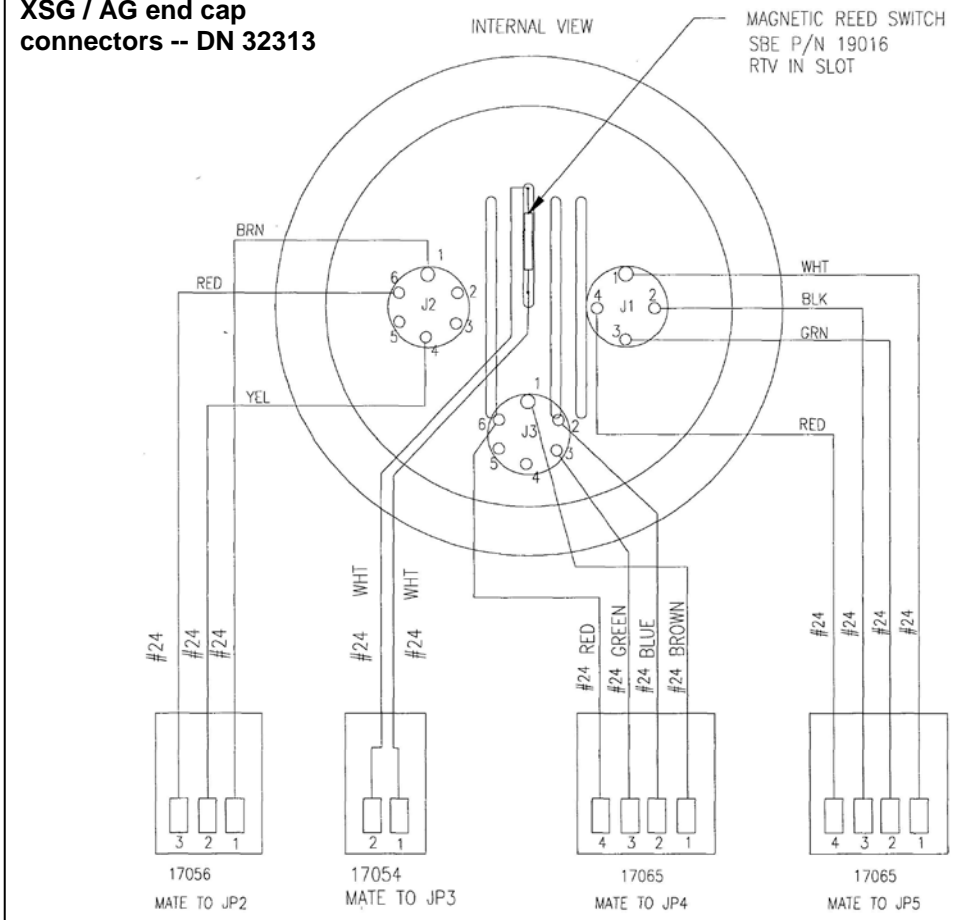

**Wet-pluggable MCBH end cap connectors -- DN 32840**

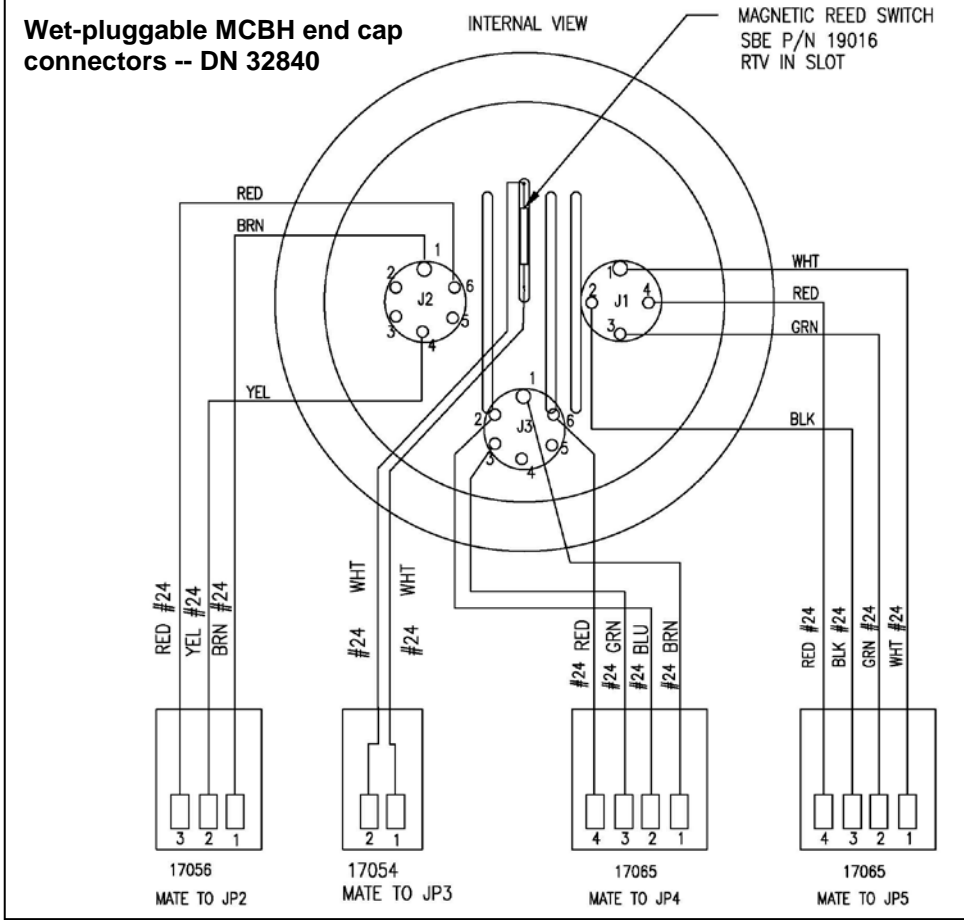

## Magnetic Reed Switch Plunger

A plunger with a magnet is mounted to the top end cap. Pushing in the plunger closes a magnetic reed switch, signaling the CPU to power the SBE 9plus and record data. If the battery voltage is greater than the low power cut-off voltage (nominally 10 volts; depends on battery type) and there is room in memory for data, Searam supplies power to the 9plus, writes a header containing real time and cast number, and begins storing 9plus data in memory. When the plunger is pulled out, Searam removes power from the 9plus and enters its low power, quiescent (sleep) state. If the plunger is left pushed in, the Searam runs until the memory is filled or the batteries are used up.

**The plunger must be pulled out when the Searam is not acquiring data from the SBE 9plus, i.e., during storage, setup, diagnostic tests, and data uploading.**

---

## Real-Time Clock

An independently-powered real-time clock provides a time stamp for each cast.

---

## Memory

**Note:**

The Searam's full scan rate is 24 Hz. The actual scan rate is:  
24 Hz / # of scans to average

(# of scans to average is set up with the **Ave=** command)

The Searam's memory is 16M byte. Searam sample capacity and memory endurance may be **estimated** by:

$$\# \text{ scans recorded (samples)} = M / (B \times W)$$

$$\text{Memory endurance} = \# \text{ scans recorded} / (\text{scan rate})$$

where:

M = memory size

B = bytes per word = 3

W = # words stored per 9plus scan =

10 - # frequency words suppressed - # voltage words suppressed

*Example:* Estimate the sample capacity and memory endurance for a Searam with no auxiliary sensors and full rate data (24 Hz, **Ave=1**):

W = 10 - 2 frequency words suppressed - 4 voltage words suppressed = 4 words (C, T, D, and Modulo)

$$\# \text{ scans recorded} = \frac{16,000,000}{(3 \times 4)} = 1,333,333$$

$$\text{memory endurance} = \frac{1,333,333 \text{ scans}}{24 \text{ Hz} \times 3600 \text{ seconds/hour}} = 15 \text{ hours}$$

**Note:**

Battery endurance for NiMH batteries is approximately 10 hours for a 9plus with no auxiliary sensors, or 7 hours for a 9plus with auxiliary sensors. Memory endurance is longer at the full data rate of 24 Hz, as shown in the example. **To take full advantage of the memory endurance, recharge or replace the batteries between deployments, or provide external power.**

With all channels (10 words per scan) stored, the Searam provides approximately 6 hours of memory endurance at the full data rate of 24 Hz.

## Data I/O

The Searam receives setup instructions and outputs diagnostic information or previously recorded data via a 3-wire RS-232C link, and is factory-configured for 9600 baud, 8 data bits, 1 stop bit, and no parity. Searam RS-232 levels are directly compatible with standard serial interface cards (IBM Asynchronous Communications Adapter or equal).

---

## Batteries

The Searam is shipped from the factory with the batteries installed, with the Searam in quiescent (sleep) state, drawing less than 50 microamps.

To preserve battery life, the Searam enters quiescent (sleep) state when:

- logging is halted by pulling out the switch plunger, or
- the Searam is not logging and more than 2 minutes has elapsed without receiving a command.

An internal A/D converter monitors the battery supply to permit orderly shut-down in the case of battery failure or exhaustion. The Searam's non-volatile memory retains all data in memory, regardless of battery failure or exhaustion.

### *Battery Pack*

The battery pack consists of twelve NiMH, rechargeable, D-cell batteries. NiMH batteries are recommended for most applications. An SBE *9plus* without auxiliary sensors can typically operate in excess of 10 hours with NiMH batteries; a system with auxiliary sensors can typically operate for at least 7 hours.

A Ni-Cad, rechargeable, D-cell battery pack or alkaline D-Cell batteries can be substituted for the NiMH batteries.

- Ni-Cad (no longer available) - A *9plus* without auxiliary sensors can typically operate in excess of 6 hours with Ni-Cad batteries; a system with auxiliary sensors can typically operate for at least 4 hours.
- Alkaline - A *9plus* without auxiliary sensors can typically operate for approximately 12 hours with alkaline batteries, depending on temperature.

### *Back-Up Power*

An auxiliary power source may be connected to the main I/O bulkhead to permit testing and data retrieval without affecting battery capacity.

#### **CAUTION:**

The Searam has no clamp or voltage drop circuitry to limit the supply voltage to the SBE *9plus*. Thus, the voltage supplied by the Searam's power supply is the voltage supplied to the *9plus*, which is also the voltage supplied by the *9plus* to all its auxiliary sensors. Some auxiliary voltage sensors, such as WET Labs ECO sensors, are limited to input voltages less than 15 volts. Twelve fully charged batteries in the Searam supply the following voltage:

- NiMH or Ni-Cad - 14.4 volts
- **Alkaline - 18 volts**

**Using alkaline batteries in the Searam for *9plus* deployments including lower input voltage sensors can damage the sensors.**

# Section 3: Preparing Searam for Deployment

This section describes software installation and the pre-check procedure for preparing the Searam for deployment.

## Software Installation

### Notes:

- Help files provide detailed information on the software. A separate software manual on the CD-ROM contains detailed information on SBE Data Processing.
- It is possible to use the Searam without SeatermAF by sending direct commands from a dumb terminal or terminal emulator, such as Windows HyperTerminal.
- Sea-Bird supplies the current version of our software when you purchase an instrument. As software revisions occur, we post the revised software on our website. See our website for the latest software version number, a description of the software changes, and instructions for downloading the software.

Seasoft V2 was designed to work with a PC running Windows XP service pack 2 or later, Windows Vista, or Windows 7 (32-bit or 64-bit).

If not already installed, install SeatermAF and other Sea-Bird software on your computer using the supplied software

1. Insert the CD in your CD drive.
2. Double click on **SeasoftV2.exe**. Follow the dialog box directions to install the software. Install all the components, or as a minimum install SeatermAF (terminal program for setting up auto fire parameters) and SBE Data Processing (data processing).

The default location for the software is c:\Program Files\Sea-Bird. Within that folder is a sub-directory for each program (SeatermAF, etc.).

## Power and Communications Test

The power and communications test will verify that the system works, prior to deployment.

### Setup

1. By hand, unscrew the locking sleeve from the I/O (4-pin) bulkhead connector. **If you must use a wrench or pliers, be careful not to loosen the bulkhead connector instead of the locking sleeve.**
2. Remove the dummy plug from the I/O bulkhead connector by pulling the plug firmly away from the connector.
3. **XSG / AG Connector** - Install the I/O cable connector, aligning the raised bump on the side of the connector with the large pin (pin 1 - ground) on the Searam. **OR**  
**MCBH Connector** – Install the I/O cable connector, aligning the pins.
4. Connect the I/O cable connector to your computer's serial port.

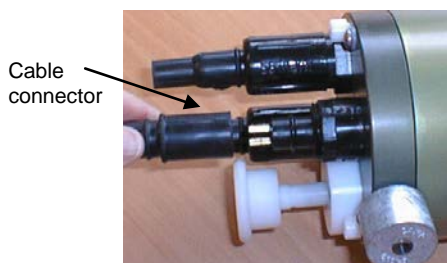
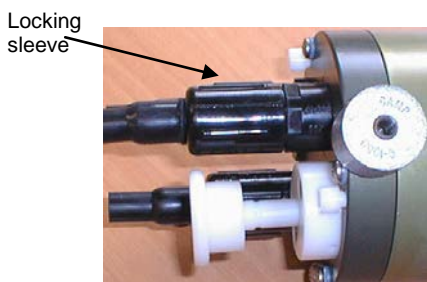

### Test and Establish Operating Parameters

**Notes:**

- SeatermAF's initialization file, SeaTermAF.ini, includes information on the last instrument used when the program was closed, and the location of that instrument's settings (.psa) file. As a default, the .ini file is saved to %USERPROFILE%\Local Settings\Apps\Sea-Bird\ (for example c:\Documents and Settings\dbresko\Local Settings\Apps\Sea-Bird\SeatermAF.ini).
- See SeatermAF's Help files.

1. Double click on SeatermAF.exe. If this is the first time the program is used, the setup dialog box appears:

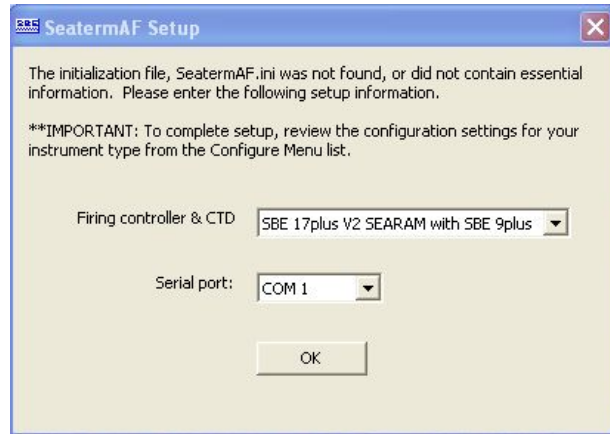

Select the auto fire instrument type and CTD (*SBE 17plus V2 SEARAM with SBE 9plus*) and the serial port for communication with the Searam. Click OK.

2. The main screen looks like this: :

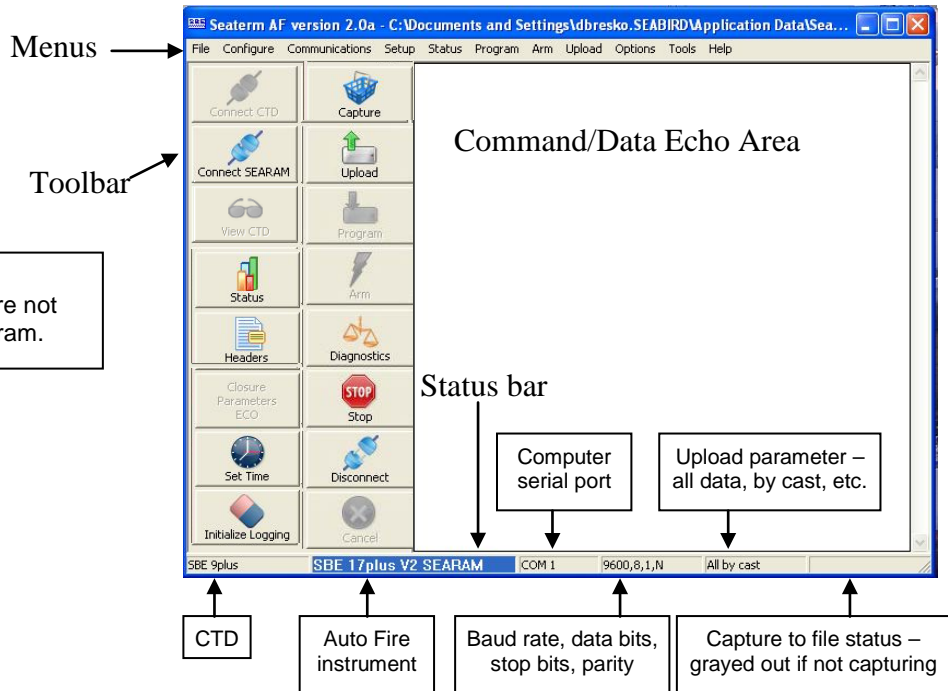

**Note:**

Connect CTD and View CTD are not applicable for use with the Searam.

**Note:**

There is at least one way, and as many as three ways, to enter a command:

- Manually type command in Command/Data Echo Area.
- Use a menu to automatically generate a command.
- Use a Toolbar button to automatically generate a command.

Description of SeatermAF main screen:

- Menu – Contains tasks and frequently executed instrument commands.
- Toolbar – Contains buttons for frequently executed tasks and instrument commands. Most tasks/commands accessed through the Toolbar are also available in the Menu. Grayed out Toolbar buttons are not applicable. To change the location of the Toolbar (at top or at left), go to the Options menu.
- Command/Data Echo Area – Echoes a command executed using a Menu or Toolbar button, as well as the instrument's response. Additionally, a command can be manually typed in this area, from the available commands for the instrument. Note that the instrument must be *awake* for it to respond to a command; use Connect SEARAM on the Toolbar to wake up the Searam).
- Status bar – Provides status information.



Following are the Toolbar buttons applicable to the Searam:

<b>Toolbar Buttons</b>	<b>Description</b>	<b>Equivalent Command*</b>
Connect SEARAM	Re-establish communications with Searam. Searam responds with S> prompt. Searam <i>goes to sleep</i> after 2 minutes without communication from computer have elapsed.	(press Enter key)
Status	Display Searam status — provide information on Searam setup and current status.	<b>DS</b>
Headers	View data headers (cast number, date and time, number of samples in cast, etc.). A new header is generated for each <i>9plus</i> cast.	<b>DH</b>
Closure Parameters SEARAM	Display all auto fire parameters and auto fire status.	<b>CP</b>
Set Time	Set <b>Searam</b> date and time to an accuracy of $\pm 25$ msec of time provided by timekeeping software on your computer (time-keeping software not provided by Sea-Bird).	<b>MMDDYY=</b> and <b>HHMMSS=</b>
Initialize Logging	Reset data pointers and cast numbers. Initialize logging after existing data has been uploaded from Searam and prior to recording new data.	<b>SampleNum=0</b>
Capture	Capture instrument responses on screen to file; may be useful for diagnostics. File has .cap extension. Click Capture again to turn off capture. Capture status displays in Status bar.	—
Upload	Upload data from Searam, in format post-processing software can use. Before using upload: <ul style="list-style-type: none"> <li>• Pull out switch plunger to stop logging.</li> <li>• Configure upload and header parameters in Configure menu.</li> </ul>	<b>DC</b>
Program	Send auto fire information input in Configure menu to Searam. Must send this information before deployment for auto fire capability to function.	—
Arm	Enable auto fire algorithm to close bottles. Must arm Searam before deployment for auto fire capability to function.	<b>Arm</b>
Diagnostics	Perform one or more diagnostic tests on Searam. Test(s) accessed in this manner are non-destructive – they do not write over any existing instrument settings.	<b>DS, VR, Flash Map</b>
Stop	Interrupt Searam's current activity, such as uploading data or performing diagnostic testing.	(press Esc key or Ctrl C)
Disconnect	Free computer serial port used to communicate with Searam. Serial port can then be used by another program.	—
Cancel	Interrupt SeatermAF's current activity, such as attempting to connect to Searam or programming auto fire.	—

\*See *Command Descriptions* in Section 4: *Deploying and Operating Searam*.

**Note:**

Seasave and SBE Data Processing versions 7.20a introduced .xmlcon files (in XML format). SeatermAF is compatible with both .xmlcon and .con configuration files.

Program setup file contains all instrument settings entered in Configuration Options dialog box. As a default, SeatermAF saves .psa file to last location and with last file name that was used for a particular combination of auto fire instrument and CTD. **You may want to save .psa files with unique names or in unique directories for reuse in future deployments.**

Configuration File – Select .xmlcon or .con file, provided by Sea-Bird. File contains pressure coefficients, required for Searam to calculate pressure from 9plus pressure frequency data. Pressures are used to determine when to close bottles, based on bottle position and closure parameters. Configuration file can be viewed and modified in SeatermAF by selecting the file (Browse button) and then clicking Modify button. SeatermAF's Configuration dialog box is identical to the one in SBE Data Processing. For details, see *Verifying Contents of Configuration (.xmlcon or .con) File* in Section 4: Deploying and Operating Searam.

- In the Configure menu, select *SBE 17plus V2 SEARAM with SBE 9plus*. The dialog box looks like this:

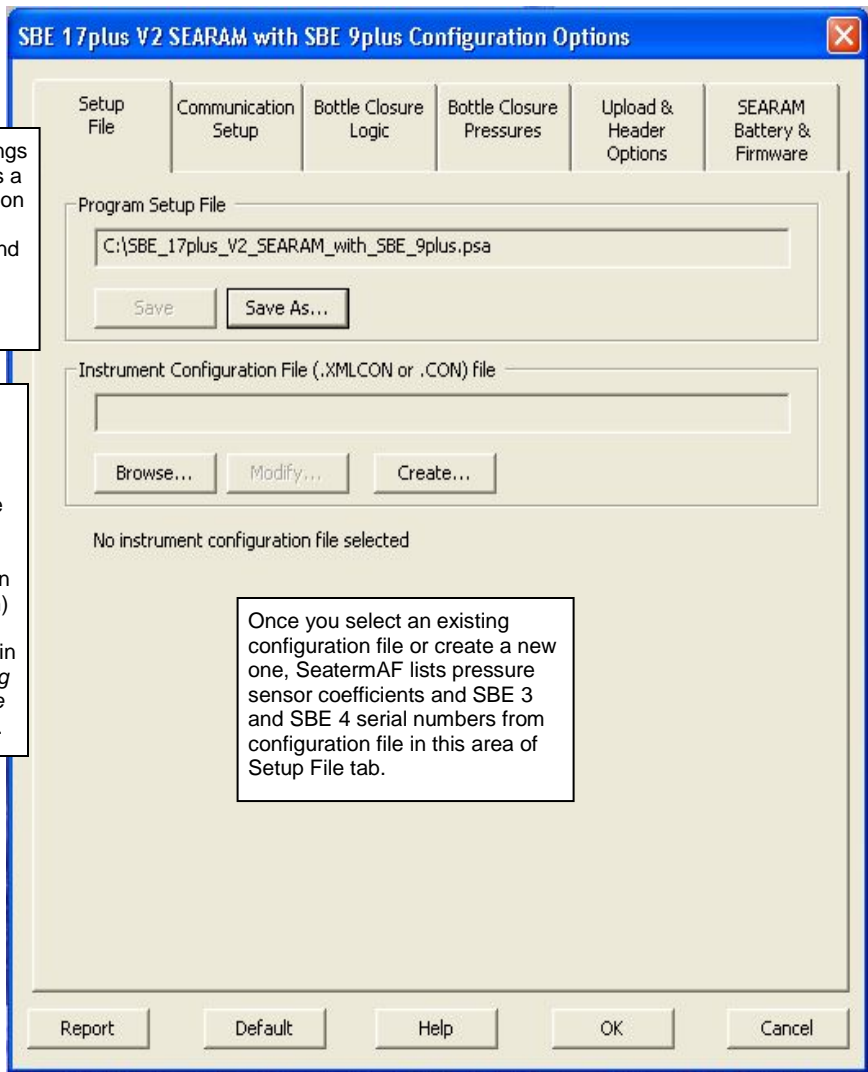

**Note:**

Only the Communication Setup settings (serial port, baud rate, data bits, and parity) and SEARAM Battery & Firmware need to be entered to test communications. Bottle Closure Logic, Bottle Closure Pressures, and Upload & Header Options (Steps 6 - 8) are not needed to test communications. These items can be entered now, or can be entered just before deployment, if desired.

- :
4. Click the Communication Setup tab. The dialog box looks like this:

Computer serial port, baud rate, data bits, and parity for communication between computer and Searam.

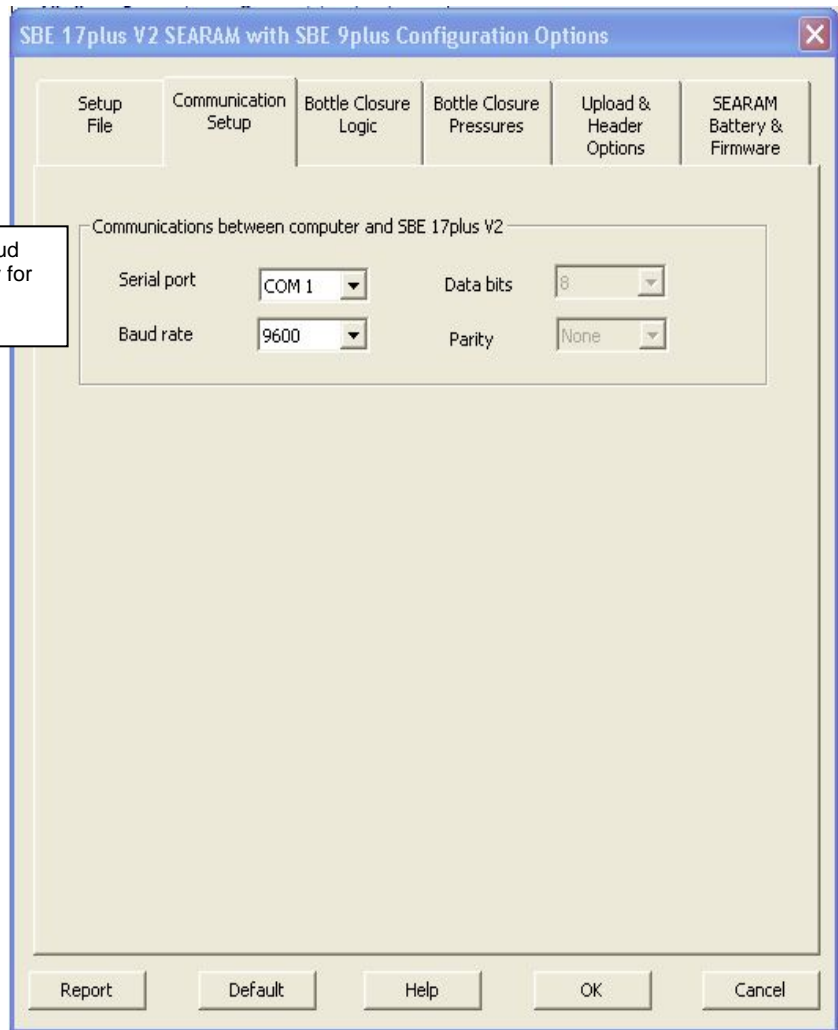

5. Click the SEARAM Battery & Firmware tab. The dialog box looks like this:

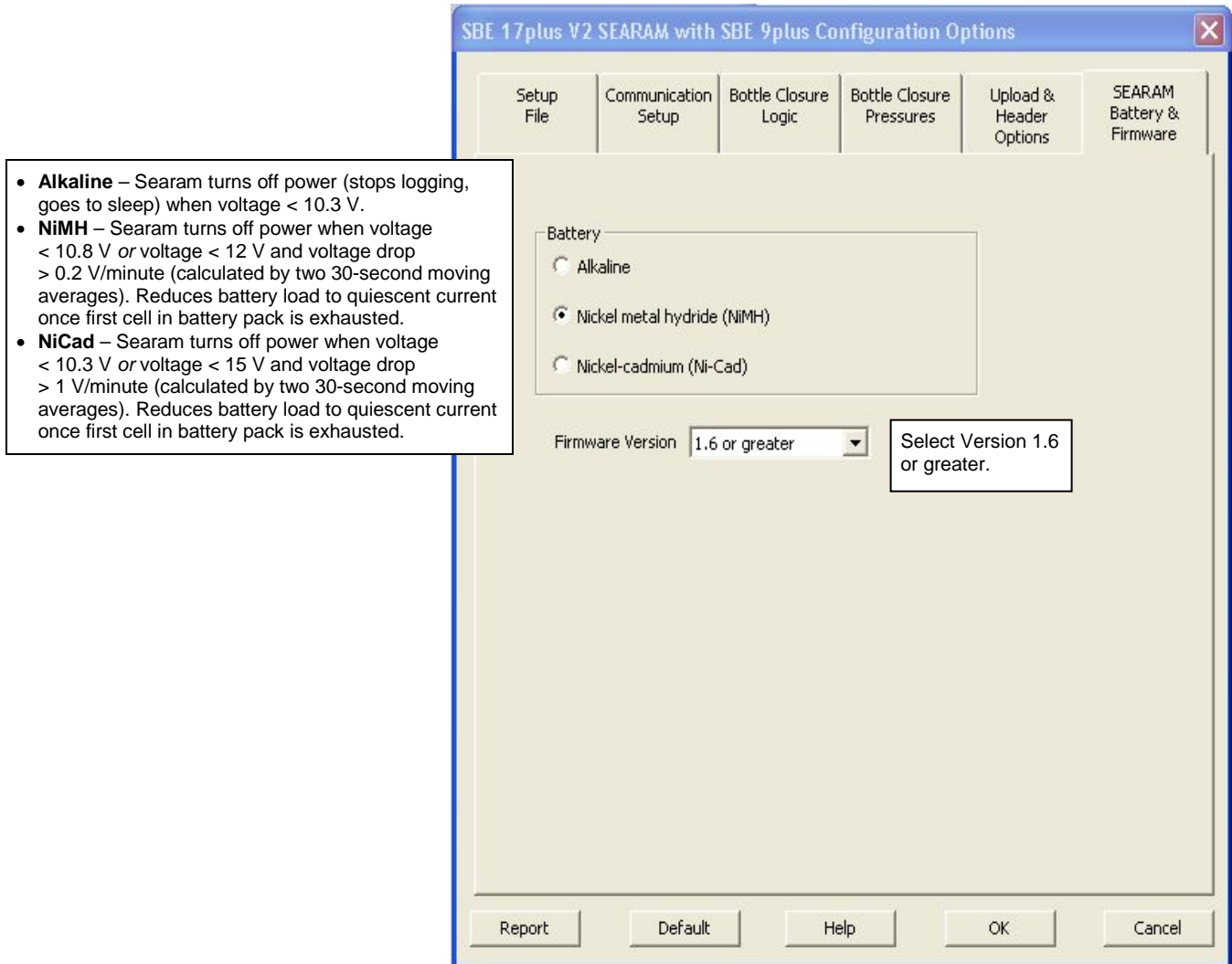

6. Click the Bottle Closure Logic tab. The dialog box looks like this:

Searam closes bottles at designated pressures on upcast. Auto Fire parameters define when bottom is reached and upcast begins, preventing incorrect bottle closure during downcast caused by temporary upward movement.

- Bottom Bottle Closure not Enabled** – Upcast is enabled when pressure is greater than *Minimum pressure to determine upcast*. If instrument never meets this criteria, upcast is enabled when pressure decreases by *Pressure Change to Enable Upcast Logic*. This ensures that water samples are taken, even if instrument did not go as deep as anticipated.
- Bottom Bottle Closure Enabled** – Bottom bottle closes and upcast is enabled when Searam determines that bottom of cast has been reached. Bottom bottle is closed when pressure is greater than *Pressure to enable bottom bottle*, and pressure remains within *Bottom pressure window* for *Stationary time on bottom*. If instrument never meets this criteria, Searam closes bottom bottle when pressure decreases by *Pressure decrease to determine upcast*. This ensures that water samples are taken, even if instrument did not go as deep as anticipated or did not stay at the bottom for as long as anticipated.

These examples use the setup shown in the dialog box above, except as noted.

**Example 1 – Bottom Bottle Closure Enabled:** *9plus* descends to 550 db (>500 db), and stays within 10 db window for 10 minutes. After 5 minutes, Searam closes bottom bottle.

**Example 2 – Bottom Bottle Closure Enabled:** *9plus* descends to 450 db (<500 db), and stays within 10 db window for 10 minutes. Because it has not reached enable pressure (500 db), bottom bottle does not close. *9plus* begins to ascend. When pressure decreases by 15 db to 435 db, Searam closes bottom bottle and any other bottles that were meant to close at depths below 435 db.

**Example 3 – Bottom Bottle Closure Disabled:** *9plus* descends to 550 db (>500 db), begins to ascend. When it reaches pressure for first bottle to close, Searam closes first bottle.

**Example 4 – Bottom Bottle Closure Disabled:** *9plus* descends to 450 db (<500 db), and begins to ascend. When pressure decreases by 15 db to 435 db, Searam closes any bottles that were meant to close at depths below 435 db.

- 7. Click the Bottle Closure Pressures tab. The dialog box looks like this:

Total number of bottles to close during deployment.

Bottles may be closed in any order desired. Closure pressure must **decrease** from closure 1 to last closure. For this example, bottom bottle closure was enabled on Bottle Closure Logic tab, so closure 1 is for bottom bottle.

Closure order	Bottle position	Closure pressure[db]	Closure order	Bottle position	Closure pressure[db]
Bottom bottle	1	stationary	13		
2	3	480	14		
3	5	440	15		
4	7	400	16		
5	9	350	17		
6	11	300	18		
7	2	250	19		
8	4	200	20		
9	6	150	21		
10	8	100	22		
11	10	50	23		
12	12	10	24		

Closure pressures must decrease from closure 1 to last bottle.

- :
8. Click the Upload & Header Options tab. The dialog box looks like this:

Defines data upload type when using Upload on Toolbar or Upload menu:

- **All data separated by cast (default)** – All data uploaded. Separate file written for each cast, with 3-digit cast ID (001, etc.) appended to user-selected file name.
- **Single cast** – During upload, SeatermAF prompts for cast number, and uploads data from that cast into one file.
- **By cast number range** – During upload, SeatermAF prompts for beginning and ending cast numbers, and uploads data within range. Separate file written for each cast, with 3-digit cast ID (001, etc.) appended to user-selected file name.
- **All data as a single file** – All data uploaded into one file.
- **By scan number range** – During upload, SeatermAF prompts for beginning and ending scan (sample) numbers, and uploads all data within range into one file.

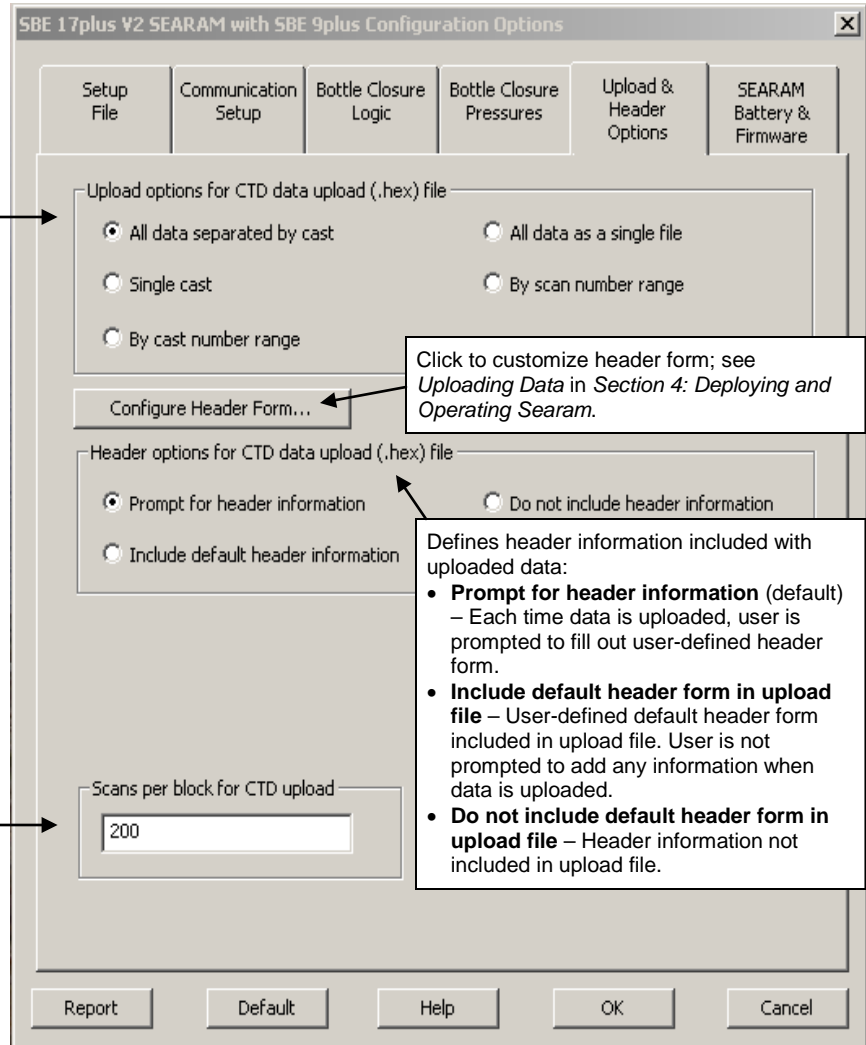

SeatermAF uploads CTD data in *blocks*, and calculates a checksum at end of each block. If block fails checksum verification, SeatermAF tries to upload block of data again, cutting block size in half. For 17plus V2, default block size is 200 scans (samples).

**Note:**

When exiting the program, SeatermAF prompts you to save the instrument settings to the .psa file if they have been modified. Alternatively, to save the settings to the .psa file while still in the Configuration Options dialog box, click on the Setup File tab and click Save or Save As.

9. Click OK to temporarily save the settings in the Configuration Options dialog box and to exit the dialog box.

10. Click Connect SEARAM on the Toolbar. The display looks like this:

```
SBE 17plus version 2 SEARAM 1.6
S>
```

This shows that correct communications between the computer and the Searam has been established.

If the Searam does not respond as shown above:

- Click Connect SEARAM again to attempt to establish communications.
- Check cabling between the computer and Searam.
- Verify the correct instrument was selected and the serial port settings were entered correctly in the Configuration Options dialog box.

11. Display Searam status information by clicking Status on the Toolbar. The display looks like this:

```
S>>ds
SBE17plus version 2 SEARAM V1.6 05/12/2013 12:30:43 batt type=NIMH
ncasts = 7 samples = 22128 free bytes= 16771072
number of frequency channels suppressed = 0
number of voltage channels suppressed = 0
number of scans averaged = 1
primary conductivity advanced 0 scans
secondary conductivity advanced 0 scans

Auto fire not armed
S>
```

12. Command the Searam to go to sleep (quiescent state) by typing **QS** and pressing the Enter key.

The Searam is ready for programming and deployment.



# Section 4:

## Deploying and Operating Searam

This section provides detailed command descriptions, data output formats, Carousel testing procedures, deployment instructions, and uploading and data processing instructions.

---

### Command Descriptions

This section describes commands and provides sample outputs. Commands can be used in various combinations to provide a high degree of operating flexibility. Review the operation of the Searam and commands before setting up your system. See *Appendix III: Command Summary* for a summarized command list.

When entering commands:

**Note:**  
**Commands to the Carousel**  
 (typically used only if you are not using our software or for testing) must be input in **UPPER CASE** (capital letters).

- Input commands in upper or lower case letters and register commands by pressing the Enter key. Verify that the command was accepted by using the status commands (**DS** for general status, **CP** for auto fire status).
- The Searam sends ? CMD if an invalid command is entered.
- If the Searam does not return an S> prompt after executing a command, press the Enter key to get the S> prompt.
- If a new command is not received within 2 minutes after completion of a command, the Searam returns to quiescent (sleep) state to prevent exhaustion of its batteries.
- **If in quiescent (sleep) state, re-establish communications by clicking Connect SEARAM on the Toolbar or pressing the Enter key to get an S> prompt.**
- Commands marked with \* (\* is not part of the command) alter the Searam's memory and require verification before executing, to prevent accidental modifications.  
 After the command entry, the Searam responds:  
 This command will clear the memory, enter command again.  
 Type in the command again, and press the Enter Key.
- Braces [ ] indicate optional command parameters. Items in braces need not be entered.
- Use Upload on the Toolbar or the Upload menu to upload data that will be processed by SBE Data Processing. Manually entering the data upload (**DC**) command does not produce data with the required header information for processing by our software.
- If the instrument is transmitting data and you want to stop it, type ^C or press the Esc key. Press the Enter key to get the S> prompt.

---

**Status Commands**

---

**DS**

Display operating status and setup parameters. List below includes, where applicable, command used to modify parameter. Equivalent to Status on Toolbar.

- firmware version, date [**MMDDYY=** or **DDMMYY=**], time [**HHMMSS=**], battery type [**BatteryType=**]
- number of stored casts and samples, and available sample space in memory
- number of frequency channels to suppress [**SF=**]
- number of voltage channels to suppress [**SV=**]
- number of scans to average [**Ave=**]
- number of scans to advance primary conductivity [**AC0=**]
- number of scans to advance secondary conductivity [**AC1=**]
- auto fire status (armed or not) [**Arm** or **Disarm**]

*Example:* Display status (user input in bold).

```
S>>ds
SBE17plus version 2 SEARAM V1.6 05/12/2013 17:09:16 batt type = NIMH      [MMDDYY=, HHMMSS=, BatteryType=]
Ncasts = 7  samples = 22128  free bytes = 16771072
Number of frequency channels suppressed = 0                               [SF=]
Number of voltage channels suppressed = 0                                 [SV=]
Number of scans averaged = 1                                           [Ave=]
Primary conductivity advanced 0 scans                                   [AC0=]
Secondary conductivity advanced 0 scans                                  [AC1=]

Auto fire not armed                                                    [Arm or Disarm]
```

**CP**

Display bottle closure parameters. Equivalent to Closure Parameters SEARAM on Toolbar.

- auto fire status (armed or not armed)
- pressure coefficients
- bottom bottle closure status
- bottom bottle time (minutes)
- bottom pressure window (db)
- pressure to enable upcast (db)
- pressure change to enable upcast (db)
- number of bottles enabled
- bottle closure sequence and pressures

*Example:* Display bottle closure parameters (user input in bold).

```
S>>CP
Auto fire armed
Pressure Coefficients:
C1 = -47027.81  C2 = -3.17762e-01  C3 = 1.41507e-02
D = 0.040116
T1 = 30.03788  T2 = -4.05515e-04  T3 = 4.15151e-06  T4 = 2.66753e-09
Adm = 0.011560  Adb = -7.898880

Bottom bottle closure enabled
Bottom bottle time 5
Bottom pressure window 20
Pressure to enable up cast 200
Pressure change to enable up cast 10
4 bottle(s) enabled for closure

Sequence #      Bottle #      Closure Pressure
1              1              200
2              2              150
3              3              100
4              4              50
```

**Notes:**

- **DDMMYY=** and **MMDDYY=** are equivalent. Either can be used to set the date.
- **It is always necessary to set date and then time.** If a new date is entered but not a new time, the new date will not be saved. If a new time is entered without first entering a new date, the date will reset to the last date it was set for with **MMDDYY=** or **DDMMYY=**.
- If the battery pack has been removed and replaced, date and time must be reset.

**Note:**

The Searam's baud (set with **Baud=**) must be the same as SeatermAF's baud rate (set in the Configure menu).

**CAUTION:**

The Searam has no clamp or voltage drop circuitry to limit the supply voltage to the SBE 9plus. Thus, the voltage supplied by the Searam's power supply is the voltage supplied to the 9plus, which is also the voltage supplied by the 9plus to all its auxiliary sensors. Some auxiliary voltage sensors, such as WET Labs ECO sensors, are limited to input voltages less than 15 volts. Twelve fully charged batteries in the Searam supply the following voltage:

- NiMH or Ni-Cad - 14.4 volts
- **Alkaline - 18 volts**

**Using alkaline batteries in the Searam for 9plus deployments including lower input voltage sensors can damage the sensors.**

**Note:**

**SampleNum=0** and **CastNum=0** do not delete data; they just reset data pointers and cast number. **If you accidentally send one of these commands before uploading,** recover data as follows:

1. Send **CastNum=x** (**x** is your estimate of number of casts in memory).
2. Send **DH**, which displays headers. If you overestimated the number of casts, all headers beyond the valid ones will be *garbage* or will have sample numbers that are inconsistent with the previous headers. If that occurs, send **CastNum=x** again, with the correct number of casts.
3. Send **SampleNum=y**, where **y** is determined from the valid **DH** output, and is (last sample number + 1).
4. Upload data. If **SampleNum** is more than the actual number of samples in memory, data for the non-existent samples will be *garbage*. Review the data and delete any *garbage* data.

**General Setup Commands**

**MMDDYY=mmddy** Set real-time clock month, day, and year.  
Must be followed by **HHMMSS=** to set time.

**DDMMYY=ddmmyy** Set real-time clock day, month, and year.  
Must be followed by **HHMMSS=** to set time.

**HHMMSS=hhmmss** Set real-time clock hour, minute, and second.

*Example:* Set date and time to December 23, 2013 19:10:26 (user input in bold).

```
S>MMDDYY=122313
Setting date: 122313
S>HHMMSS=191026
04/23/2000 19:10:26
```

**Baud=x**

**x=** baud rate for communication with computer and for uploading data (300, 600, 1200, 2400, 4800, 9600, 19200, or 38400).

**BatteryType=x**

**x=nimh:** Set battery type to NiMH. Searam turns off power (stops logging and goes to sleep) when voltage < 10.8 volts *or* voltage < 12 volts and voltage drop > 0.2 volt/minute (calculated by two 30-second moving averages). This reduces battery load to quiescent current (50 microamps) once first cell in battery pack is exhausted.

**x=nicad:** Set battery type to Ni-Cad. Searam turns off power (stops logging and goes to sleep) when voltage < 10.3 volts *or* voltage < 15 volts and voltage drop > 1 volt/minute (calculated by two 30-second moving averages). This reduces battery load to quiescent current (50 microamps) once first cell in battery pack is exhausted.

Note: Ni-Cad battery pack and charger no longer available.

**x=alkaline:** Set battery type to alkaline. Searam turns off power (stops logging and goes to sleep) when voltage < 10.3 volts.

**SampleNum=0 \* or CastNum=0 \***

Initialize logging. Use one of these commands to reset data pointers and cast number **after existing data has been uploaded from Searam** and prior to recording new data. Sending *either* command sets both **SampleNum** and **CastNum** to 0.

When switch plunger is pushed in, recording begins immediately. First time switch is pushed in after receipt of **SampleNum=0** or **CastNum=0**, recording starts at beginning of memory and any previously recorded data is written over, whether memory has been erased (see **Erase Memory**) or not. When plunger is pulled out, recording stops. Each time plunger is pushed in again, recording continues with new data stored after previously recorded data and a new header written to indicate time, date, incremented cast number, and sample numbers contained in cast. Up to 100 casts can be taken or until memory is full.

**General Setup** Commands (*continued*)

**Erase Memory** \* Erase memory, **destroying all data in Searam**. All data bits are set to 1; sample number, header number, and data pointers are set to 0. Erasing memory is optional, as Searam writes over previously recorded information when **SampleNum=0** or **CastNum=0** is used. Knowledge of initial memory contents (i.e., all 1s) can be a useful cross check when data is uploaded.

**Note:**

Searam automatically enters sleep state after 2 minutes have elapsed without receiving a command.

**QS** Quit session and place Searam in quiescent (sleep) state. Main power is turned off; memory retention is unaffected.

**SBE 9plus Setup** Commands

**Ave=x** x= number of 9plus scans to average in Searam (1 - 96). Averaging reduces data storage requirements, but also reduces resolution.

*Example:* Set number of scans to average to 12, providing effective scan rate of 2 Hz (=24 Hz / 12) (user input in bold).

S>**AVE=12**

**Notes:**

For **Ave=**, **SF=**, and **SV=**:

- See *Data Output Formats* after these *Command Descriptions* for details on how these parameters affect data storage in the Searam.
- The 9plus configuration (.xmlcon or .con) file must match these selections when processing uploaded data. View and edit the .xmlcon or .con file in SBE Data Processing. Note that these parameters are factory-set to match the ordered instrument configuration.

**SF=x** x= number of 9plus frequency channels to suppress in Searam. Unused channels are not stored in memory, providing more data space. Frequency channels store temperature (T), conductivity (C), and pressure (P) sensor frequency output. P and primary T and C cannot be suppressed. Secondary T and C can be suppressed if desired.

x= 0: SBE 3 or 4 connected to JB5 on 9plus bottom end cap (dual redundant sensor configuration).

x= 1: SBE 3 or 4 connected to JB4 on 9plus bottom end cap and not using JB5 (single redundant sensor configuration).

x= 2: Not using redundant sensors.

**SV=x** x= number of 9plus voltage channels to suppress in Searam (x = 0, 2, 4, 6, or 8). Unused channels are not stored in memory, providing more data space. Voltage channels store output from auxiliary voltage sensors, such as dissolved oxygen, pH, altimeters, transmissometers, fluorometers, etc.

9plus has 4 voltage words; each word contains data from two 12-bit A/D channels (8 channels total). Searam can suppress voltage channels above highest numbered channel being used.

<u>9plus Connector</u>	<u>Uses Channels</u>
JT2 (AUX1)	0 and 1
JT3 (AUX2)	2 and 3
JT5 (AUX3)	4 and 5
JT6 (AUX4)	6 and 7

*Example:* 9plus has pH sensor connected to AUX2, with no other voltage sensors. With sensor connected to AUX2, channels 2 and 3 are used. Suppress channels 4 through 7 (4 channels) (user input in bold).

S>**SV=4**

Note that if sensor is connected instead to AUX1, channels 2 through 7 (6 channels) could be suppressed.

---

**SBE 9plus Setup Commands** (*continued*)
 

---

**Note:**

SBE 9plus systems with atypical flow paths (for example, supporting flow-through fluorometers) may require different settings. See the Align CTD module in the SBE Data Processing manual and Application Note 38 for calculation of optimal advance values.

**AC0=x**

**x**= number of 9plus scans (**x** = 0-3) to advance *primary* conductivity from *primary* temperature in Searam, to align conductivity and temperature data. Conductivity measurement on a water parcel is delayed because 9plus TC duct presents water to conductivity sensor after water has passed temperature sensor. Since pump sets a constant flow speed, delay is constant. To nullify delay so salinity can be computed with minimum spiking, Searam can advance conductivity measurement in time to coordinate it with appropriate temperature measurement. This advance occurs *before* any averaging, so a bias error is not introduced in salinity calculated when processing uploaded data. For most applications, correct setting (and factory default) is 2 scans ( $\approx 0.073$  seconds \* 24 scans/second). See Configuration Sheet for setting for your unit. If saving full rate (24 Hz) data, you can correct any residual time misalignment in post-processing (Align CTD module in SBE Data Processing).

**AC1=x**

**x**= number of 9plus scans (**x** = 0-3) to advance *secondary* conductivity from *secondary* temperature in Searam, to align conductivity and temperature data. See discussion above for **AC0=**.

**Fx**

Turn Searam power to 9plus on or off, instead of using Searam's switch plunger. This may be convenient for testing purposes. Note that this command **does not start logging**.

**x=O**: Turn power to 9plus on.

**x=F**: Turn power to 9plus off.

**Note:**

Start logging by pushing in Searam's switch plunger. Stop logging by pulling out Searam's switch plunger.

---

**SBE 32 Carousel Setup Commands**

---

**Cx**

Turn Searam power to Carousel on or off, instead of using Searam's switch plunger. This may be convenient for testing purposes. Note that this command **does not start logging**.

**x=O**: Turn power to Carousel on.

**x=F**: Turn power to Carousel off.

**Note:**

Commands to the Carousel must be input in UPPER CASE (capital letters).

**#XXX**

Relay character string defined by **XXX** to Carousel. **XXX** can be any command recognized by Carousel. See Carousel manual for list of commands. See *Testing SBE 32 Carousel Water Sampler Operation* below for an example of how to use this command for testing system before deployment.

---

**Auto Fire Arm/Disarm Commands**

---

Arm before deploying to enable the Carousel to take water samples. Disarm before deploying to disable the Carousel from taking water samples; the SBE 9plus can still take samples and log data in the Searam.

**Arm** Arm (enable) auto fire to close bottles.  
Equivalent to ARM on Toolbar.

**Disarm** Disarm (disable) auto fire.

---

**Data Upload Commands**

---

These commands upload data from the Searam's memory. Pull out the Searam's switch plunger to stop logging before uploading data.

**DC [x]** Display raw data in hex from cast **x**.  
If **x** omitted, data from cast 0 displays.

*Example:* Upload data for cast 2 (user input in bold)

S>>**DC 2**

Y indicates valid cast number

aaaaaabbbbbbbccccccccddddd (cast # 2, scan 0 data)

aaaaaabbbbbbbccccccccddddd (cast # 2, scan 1 data)

...

aaaaaabbbbbbbccccccccddddd cast # 2, scan x data

(x+1 is total number of scans of data stored in cast 2)

**DD [x1,x2]** Display raw data in hex from scan **x1** through **x2**.

If **x1** and **x2** omitted, data displays from every scan.

*Example:* Upload data for scans 2 through 3 (user input in bold)

S>>**DD 2,3**

aaaaaabbbbbbbccccccccddddd (scan 2 data)

aaaaaabbbbbbbccccccccddddd (scan 3 data)

**Notes:**

- **Use Upload on the Toolbar or the Upload menu to upload data that will be processed by SBE Data Processing.** Manually entering a data upload command does not produce data with the required header information for processing by our software. These commands are included for reference for users who are writing their own software.
- To save data to a file, click Capture on the Toolbar before entering a data upload command.
- The first cast is cast 0.
- See *Data Output Formats* after these *Command Descriptions*.

**Note:**

A new header is written each time logging starts or resumes.

**DH** Display headers from all casts.

*Example:* Display headers (user input in bold).

S>>**DH**

cast 0 09/09/2013 08:01:15 avg=4 nfs=2 nvs=4 smpls 0 to 3540 stop=switch off v=15.23

cast 1 09/09/2013 12:30:33 avg=4 nfs=2 nvs=4 smpls 3541 to 8795 stop=switch off v=14.50

cast 2 09/09/2013 15:45:11 avg=4 nfs=2 nvs=4 smpls 8796 to 9801 stop=battery low v=13.33

where:

cast n = cast number.

mm/dd/yyyy hh:mm:ss = month day hour minute second when cast started.

avg = number of scans averaged by Searam.

nfs = frequency channels suppressed. nvs = voltage words suppressed.

x to y = first to last sample (scan) in cast.

stop = reason logging stopped (*switch off* if switch plunger pulled out, *battery low* if voltage dropped below minimum allowed, *bfrate* if voltage drops too rapidly [indicating failure of at least 1 battery], *memory full*, *memory failure*, *unknown*).

v = battery voltage when Searam stopped logging.

---

**Diagnostic Commands**

---

<b>BV</b>	Display main battery voltage.
<b>BI</b>	Display main battery current (amps).
<b>VR</b>	Continuously display power – main battery voltage and operating current (amps). Searam switches on power to <i>9plus</i> and Carousel, so operating current is total current drawn by Searam, <i>9plus</i> , and Carousel. Press Esc key to stop test.
<b>TestEE</b>	Test EEPROM.
<b>Flash Initialize *</b>	Perform memory test, <b>destroying all data in Searam</b> . This test maps any bad data blocks in memory, allowing Searam to avoid using those blocks when recording data. Test requires approximately 20 minutes to perform, and cannot be stopped once it begins.
<b>Flash Map</b>	Display results of mapping from <b>Flash Initialize</b> . Press Esc key to abort at any time.

## Commands Not Typically Sent by User

The user does not typically send the remaining commands. These involve setting up auto fire parameters, which are more easily set up in the Configuration Options dialog box (select *SBE 17plus V2 with SBE 9plus* in the Configure menu). SeatermAF automatically sends these commands (with values based on entries in the dialog box) to the Searam when the user clicks Program on the Toolbar. The commands are included here for reference only. **Sea-Bird highly recommends using the Configuration Options dialog box to set up the Searam instead of using these commands.** See *Test and Establish Operating Parameters* in Section 3: *Preparing Searam for Deployment*.

**Note:**

Verify auto fire parameters - auto fire general setup, bottom bottle closure and upcast logic setup, and pressure coefficients - with the **CP** command before deploying the system.

### *Auto Fire General Setup*

**NB=x**

**x** = total number of bottles to be closed during deployment. Maximum 24 bottles.

**BC n,m**

Define bottle closure pressure – bottle closure **n** occurs at pressure **m** (decibars). Repeat **NB** times, providing each closure pressure. Default 0 decibars for each bottle.

**BS n,m**

Searam allows bottles to be fired out of numerical sequence. Bottle closure **n** causes bottle number **m** to close. Repeat **NB** times, providing closure sequence for each bottle. Default is **n** equals **m** (bottles close in order of bottle number).



### ***Auto Fire Bottle Bottom Closure and Upcast Logic Setup***

The Searam closes bottles at designated pressures on upcast. However, the package sometimes moves upward during downcast, due to ship movement. These commands establish when upcast begins, preventing bottle closure during downcast caused by temporary upward movement. There are two cases:

- Bottom bottle closure not enabled – Upcast is enabled when pressure is greater than **BUP** decibars, or has decreased by **BUD** decibars from its maximum value.
- Bottom bottle closure enabled – Bottom bottle closure and upcast are enabled when pressure is greater than **BUP** decibars and remains within a window of **BBP** decibars for **BBT** minutes. If *9plus* never meets these criteria, Searam closes bottom bottle when pressure decreases by **BUD** decibars.

<b>BBx</b>	x= Y (default): Enable bottom bottle closure – close a bottle when pressure remains within <b>BBP</b> decibars for <b>BBT</b> minutes. x= N: Disable bottom bottle closure.
<b>BBP=x</b>	x = bottom bottle pressure window (decibars).
<b>BBT=x</b>	x = bottom bottle time (minutes).
<b>BUP=x</b>	x = pressure (decibars) to enable upcast.
<b>BUD=x</b>	x = pressure decrease (decibars) from maximum to enable upcast.

The examples all use the following parameters: **BBP**=10 decibars, **BBT**=5 minutes, **BUP**=500 decibars, **BUD**=15 decibars

*Example 1 – **BBY** (bottom closure enabled):* *9plus* descends to 550 db (> 500db) and stays within a 10 db window for 10 minutes. After 5 minutes, Searam closes bottom bottle.

*Example 2 – **BBY** (bottom closure enabled):* *9plus* descends to 450 db (< 500 db) and stays within a 10 db window for 10 minutes. Because it has not reached enable pressure (500 db), bottom bottle does not close. Package begins to ascend. When pressure decreases by 15 db to 435 db, Searam closes bottom bottle and any other bottles that were meant to close at depths below 435 db.

*Example 3 – **BBN** (bottom closure disabled):* *9plus* descends to 550 db (> 500 db) and begins to ascend. When it reaches pressure for first bottle to close, Searam closes first bottle.

*Example 4 – **BBN** (bottom closure disabled):* *9plus* descends to 450 db (< 500 db) and begins to ascend. When pressure decreases by 15 db to 435 db, Searam closes any bottles that were meant to close at depths below 435 db.

### ***SBE 9plus Pressure Coefficients***

These commands set up the *9plus* pressure sensor calibration coefficients, used by the Searam to calculate pressures from the pressure sensor frequency data. Those pressures are used to determine when to close bottles.

**Note:**

See the *9plus* pressure sensor calibration sheet or the configuration (.xmlcon or .con) file for the calibration coefficients.

<b>PC1=x</b>	x = C1 coefficient
<b>PC2=x</b>	x = C2 coefficient
<b>PC3=x</b>	x = C3 coefficient
<b>PD=x</b>	x = D coefficient
<b>PT1=x</b>	x = T1 coefficient
<b>PT2=x</b>	x = T2 coefficient
<b>PT3=x</b>	x = T3 coefficient
<b>PT4=x</b>	x = T4 coefficient
<b>PADM=x</b>	x = Adm coefficient
<b>PADB=x</b>	x = Adb coefficient

## Data Output Formats

### Notes:

- *9plus* output format differs from the Searam's in several respects:
  - The Searam changes the order of the output.
  - The Searam strips *9plus* bytes 31-36 (unused and marker bytes) and any unused frequency or voltage channels from the data.
  - The Searam overwrites the bottle confirm bit from the *9plus* to record each Carousel bottle closure (*9plus* only sets the bottle confirm bit when used with a G.O. 1015 Rosette, not with an SBE 32 Carousel Water Sampler). The Searam sets the bit high for 1.5 seconds to record each closure. See the *9plus* manual.
- *9plus* data uploaded from the Searam is in a .hex file. Real-time *9plus* data, acquired through an *11plus* Deck Unit with Seasave, is one of the following file types:
  - Seasave (versions < 6.0) saved data coming from the Deck Unit as a .dat file.
  - Seasave V7 (versions ≥ 7.0) saved data coming from the Deck Unit as a .hex file. See the *11plus* manual.

## Data Storage

Data uploaded from the Searam as a .hex file. Data is stored 3 bytes per SBE *9plus* word, except for the pressure word (4 bytes). When uploaded, the binary data is converted to ASCII hex and a carriage return and line feed is sent after the last byte in the scan. The Searam automatically suppresses any unused words from the *9plus*. When no frequency or voltage channels are suppressed, data storage in the Searam is:

Searam	Sensor
bytes 0-2	Frequency channel – Primary temperature
bytes 3-5	Frequency channel – Primary conductivity
bytes 6-9	Frequency channel – Pressure
bytes 10-12	Frequency channel – Secondary temperature
bytes 13-15	Frequency channel – Secondary conductivity
byte 16	Voltage channel 0 (8 MSBs)
byte 17	Voltage channel 0 (4 LSBs 4-7), Voltage channel 1 (4 MSBs 0-3)
byte 18	Voltage channel 1 (8 LSBs)
byte 19	Voltage channel 2 (8 MSBs)
byte 20	Voltage channel 2 (4 LSBs 4-7), Voltage channel 3 (4 MSBs 0-3)
byte 21	Voltage channel 3 (8 LSBs)
byte 22	Voltage channel 4 (8 MSBs)
byte 23	Voltage channel 4 (4 LSBs 4-7), Voltage channel 5 (4 MSBs 0-3)
byte 24	Voltage channel 5 (8 LSBs)
byte 25	Voltage channel 6 (8 MSBs)
byte 26	Voltage channel 6 (4 LSBs 4-7), Voltage channel 7 (4 MSBs 0-3)
byte 27	Voltage channel 7 (8 LSBs)
byte 28	Pressure sensor temperature MSBs
byte 29	4 LSB = <i>9plus</i> status (pump, bottom contact, water sampler bottle confirm bit, and modem), 4 MSB = pressure sensor temperature LSBs
byte 30	Modulo count (EOI line asserted)

When frequency or voltage channels are suppressed, the suppressed bytes are:

Channel Type	Number of Channels Suppressed	Bytes Suppressed
Frequency	1	13-15
	2	10-15
Voltage (2 channels per word)	2	25-27
	4	22-27
	6	19-27
	8	16-27

*Example:* Stored data for a CTD-only system (no secondary or auxiliary sensors) has 2 frequency channels suppressed and 8 voltage channels suppressed. The data format is:

Searam	Sensor
byte 0-2	Primary temperature
byte 3-5	Primary conductivity
byte 6-9	Pressure
byte 10	Pressure sensor temperature MSBs
byte 11	4 LSB = <i>9plus</i> status, 4 MSB = pressure sensor temperature LSBs
byte 12	Modulo count (EOI line asserted)

## Detailed Description of Data Formats

The formats for each type of data are:

### Notes:

- See the SBE Data Processing manual or Help files for instructions on converting the ASCII hex data.
- See the sensor calibration certificates for conversion of temperature and conductivity frequencies to engineering units.
- See the auxiliary sensor manual or the auxiliary sensor calibration certificates for conversion of voltages to engineering units.

Format Type	Type of Data
1	Temperature or Conductivity frequency, if number of scans averaged is less than 8 ( <b>Ave</b> < 8)
2	Pressure frequency, if number of scans averaged is less than 8 ( <b>Ave</b> < 8)
3	Modulo
4	Voltage (channels for auxiliary sensors)
5	Temperature, Conductivity, or Pressure frequencies, if number of scans averaged is greater than or equal to 8 ( <b>Ave</b> ≥ 8)

A detailed description of each type of data follows. To convert the ASCII hex data to a frequency or voltage (as applicable), use the Data Conversion module in SBE Data Processing.

### Format Type 1:

#### *Unconverted temperature and conductivity frequency, if Ave < 8*

ASCII hex data (uploaded) = 6 characters c1,c2,c3,c4,c5,c6

SBE Data Processing performs the following calculations:

- Convert ASCII hex data to decimal = d1,d2,d3,d4,d5,d6
- Calculate -
 
$$p = 288000 * \text{number of scans averaged}$$

$$nr = d1 * 256 + d2 * 16 + d3$$

$$nz = d4 * 256 + d5 * 16 + d6$$

$$\text{frequency} = nz * 6912000 / (p + nr - nrFromPreviousScan)$$

#### *Example of Calculation performed in Data Conversion (in SBE Data Processing):*

ASCII hex data sample 0 = 1AE3B5

ASCII hex data sample 1 = 2C33B5

number of scans to average = 2

sample 0: d1 = 1, d2 = 10, d3 = 14

d4 = 3, d5 = 11, d6 = 5

$nr = (1 * 256) + (10 * 16) + 14 = 430$

$nz = (3 * 256) + (11 * 16) + 5 = 949$

sample 1: d1 = 2, d2 = 12, d3 = 3

d4 = 3, d5 = 11, d6 = 5

$nr = (2 * 256) + (12 * 16) + 3 = 707$

$nz = (3 * 256) + (11 * 16) + 5 = 949$

$\text{frequency sample 1} = 949 * 6912000 / [(288000 * 2) + 707 - 430]$   
 $= 11382.526 \text{ Hz}$

**Format Type 2: Unconverted pressure frequency, if Ave < 8**

ASCII hex data (uploaded) = 8 characters c1,c2,c3,c4,c5,c6,c7,c8

SBE Data Processing performs the following calculations:

- Convert ASCII hex data to decimal = d1,d2,d3,d4,d5,d6,d7,d8
- *Standard Resolution Pressure Frequency Calculations* -  
 $p = 288,000 * \text{number of scans averaged}$   
 $nr = d1 * 4096 + d2 * 256 + d3 * 16 + d4$   
 $nz = d5 * 4096 + d6 * 256 + d7 * 16 + d8$   
 $\text{frequency} = nz * 6,912,000 / (p + nr - nrFromPreviousScan)$

*Example of Calculation performed in Data Conversion (in SBE Data Processing):*

ASCII hex data sample 0 = 004510B5

ASCII hex data sample 1 = 00AB10B4

number of scans to average = 3

sample 0: d1 = 0, d2 = 0, d3 = 4, d4 = 5,

d5 = 1, d6 = 0, d7 = 11, d8 = 5

 $nr = (0 * 4096) + (0 * 256) + (4 * 16) + 5 = 69$  $nz = (1 * 4096) + (0 * 256) + (11 * 16) + 5 = 4277$ 

sample 1: d1 = 0, d2 = 0, d3 = 10, d4 = 11

d5 = 1, d6 = 0, d7 = 11, d8 = 4

 $nr = (0 * 4096) + (0 * 256) + (10 * 16) + 11 = 171$  $nz = (1 * 4096) + (0 * 256) + (11 * 16) + 4 = 4276$ 

$$\text{frequency sample 1} = 4276 * 6,912,000 / [(288,000 * 3) + 171 - 69]$$

$$= 34203.962 \text{ Hz}$$

- *High Resolution Pressure Frequency Calculations* -  
 $p = 1,152,000 * \text{number of scans averaged}$   
 $nr = d1 * 4096 + d2 * 256 + d3 * 16 + d4$   
 $nz = d5 * 4096 + d6 * 256 + d7 * 16 + d8$   
 $\text{frequency} = nz * 27,648,000 / (p + nr - nrFromPreviousScan)$

*Example of Calculation performed in Data Conversion (in SBE Data Processing):*

ASCII hex data sample 0 = 034510B5

ASCII hex data sample 1 = 15AB10B4

number of scans to average = 3

sample 0: d1 = 0, d2 = 3, d3 = 4, d4 = 5,

d5 = 1, d6 = 0, d7 = 11, d8 = 5

 $nr = (0 * 4096) + (3 * 256) + (4 * 16) + 5 = 837$  $nz = (1 * 4096) + (0 * 256) + (11 * 16) + 5 = 4277$ 

sample 1: d1 = 1, d2 = 5, d3 = 10, d4 = 11

d5 = 1, d6 = 0, d7 = 11, d8 = 4

 $nr = (1 * 4096) + (5 * 256) + (10 * 16) + 11 = 5547$  $nz = (1 * 4096) + (0 * 256) + (11 * 16) + 4 = 4276$ 

$$\text{frequency sample 1} = 4276 * 27,648,000 / [(1,152,000 * 3) + 837 - 5547]$$

$$= 34254.684 \text{ Hz}$$

**Format Type 3: Modulo word**

ASCII hex data (uploaded) = 6 characters c1,c2,c3,c4,c5,c6

SBE Data Processing performs the following calculations:

- Convert ASCII hex data to decimal = d1,d2,d3,d4,d5,d6
- Calculate -
 
$$m0 = d1 * 16 + d2$$

$$m1 = d3 * 16 + d4$$

$$m2 = d5 * 16 + d6$$

m0 and the first four bits of m1 is the pressure sensor temperature compensation information. m2 is the incrementing modulo count.

*Example of Calculation performed in Data Conversion (in SBE Data Processing):*

ASCII hex data = A500C7

d1 = 10, d2 = 5, d3 = 0, d4 = 0, d5 = 12, d6 = 7

$m0 = (10 * 16) + 5 = 165$

$m1 = (0 * 16) + 0 = 0$

$m2 = (12 * 16) + 7 = 199$

**Format Type 4: Voltages (two 12 bit A/D channels)**

ASCII hex data (uploaded) = 6 characters c1,c2,c3,c4,c5,c6

SBE Data Processing performs the following calculations:

- Convert ASCII hex data to decimal = d1,d2,d3,d4,d5,d6
- Calculate -
 
$$N(a) = d1 * 256 + d2 * 16 + d3$$

$$N(b) = d4 * 256 + d5 * 16 + d6$$

$$V(a) = 5 [1 - (N(a) / 4095)] \text{ volts}$$

$$V(b) = 5 [1 - (N(b) / 4095)] \text{ volts}$$

*Example of Calculation performed in Data Conversion (in SBE Data Processing):*

ASCII hex data = 4510B5

d1 = 4, d2 = 5, d3 = 1, d4 = 0, d5 = 11, d6 = 5

$N(a) = (4 * 256) + (5 * 16) + 1 = 1105$

$N(b) = (0 * 256) + (11 * 16) + 5 = 181$

$V(a) = 5 [1 - (1105 / 4095)] = 3.651 \text{ volts}$

$V(b) = 5 [1 - (181 / 4095)] = 4.779 \text{ volts}$

**Format Type 5:**

**Converted temperature, conductivity, or pressure frequency if Ave  $\geq 8$**

ASCII hex data (uploaded) = 6 characters c1,c2,c3,c4,c5,c6

SBE Data Processing performs the following calculations:

- Convert ASCII hex data to decimal = d1,d2,d3,d4,d5,d6
- Calculate -
 
$$\text{frequency} = d1 * 4096 + d2 * 256 + d3 * 16 + d4 + d5/16 + d6/256$$

One byte with the value 0 follows the converted pressure frequency.

*Example of Calculation performed in Data Conversion (in SBE Data Processing):*

ASCII hex data = 4510B5

d1 = 4, d2 = 5, d3 = 1, d4 = 0, d5 = 11, d6 = 5

$\text{frequency} = (4 * 4096) + (5 * 256) + (1 * 16) + 0 + (11/16) + (5/256)$   
 $= 17680.707 \text{ Hz}$

## Frequency Limitations Imposed by Averaging

To prevent internal overflow when Searam is averaging frequency data, limits are placed on maximum sensor frequency. Note that the Searam operates at 24 Hz (24 SBE 9plus scans per second).

**Note:**

**Ave** = number of scans to average

**Format Type 1** (Unconverted temperature and conductivity frequency, if **Ave** < 8):

Maximum output frequency  $\leq$   
 $(4095 * \# \text{ of } 9plus \text{ scans per second}) / \mathbf{Ave}$

Frequencies up to 14,040 Hz can be accommodated with **Ave** = 7, and higher frequencies can be accommodated with smaller values of **Ave**.

Sea-Bird temperature and conductivity sensors have frequency outputs in the range of 2800 to 12,000 Hz.

**Format Type 2** (Unconverted pressure frequency, **Ave** < 8) and

**Format Type 5** (Converted temperature, conductivity, or pressure frequency, **Ave**  $\geq$  8) for **Standard Resolution Digiquartz**

Maximum output frequency  $\leq$   
 $(65535 * \# \text{ of } 9plus \text{ scans per second}) / \mathbf{Ave}$

Frequencies up to 65,535 Hz can be accommodated with **Ave** up to 24, sufficient to acquire the relatively high frequencies (up to 42,000 Hz)

generated by standard resolution Paroscientific Digiquartz pressure sensors. For an SBE 9plus not using a Digiquartz sensor, frequencies up to 16,384 Hz can be accommodated with **Ave** = 96 (maximum value for this parameter).

**Format Type 5** (Converted temperature, conductivity, or pressure frequency, **Ave**  $\geq$  8) for **High Resolution Digiquartz**

Maximum output frequency  $\leq$   
 $(39768 * \# \text{ of } 9plus \text{ scans per second}) / \mathbf{Ave}$

## Testing SBE 32 Carousel Water Sampler Operation

### Notes:

- Enter Carousel commands using UPPER CASE (capital letters).
- See the SBE 32 Carousel Water Sampler manual.

Test the SBE 32 Carousel Water Sampler in the lab, before deployment, to ensure that the Carousel responds to commands and that the firing mechanism functions properly. **CO** allows you to provide power to the Carousel without logging data to the Searam, and **#XXX** (**XXX** is any valid Carousel command) allows you to send commands to the Carousel through the Searam.

1. Connect the Carousel to the Searam.
2. Connect the Searam to the computer, start SeatermAF, and configure it for the Searam (see *Power and Communications Test* in *Section 3: Preparing Searam for Deployment*).
3. In SeatermAF, click Connect SEARAM on the Toolbar to establish communications with the Searam.
4. Type **CO** and press the Enter key to turn on power from the Searam to the Carousel.
5. Type **#SR** and press the Enter key to send the reset command to the Carousel.
6. **To manually simulate sequential firing:**  
Type **#SF** (fire first or next bottle) and press the Enter key. Repeat as desired.
7. **To manually simulate firing in user-specified order:**  
Type **#SNx** (where **x**= bottle position number in ASCII; first bottle position number is 1) and press the Enter key. Repeat as desired.

Position #	Command	Position #	Command
1	<b>#SN1</b>	13	<b>#SN=</b>
2	<b>#SN2</b>	14	<b>#SN&gt;</b>
3	<b>#SN3</b>	15	<b>#SN?</b>
4	<b>#SN4</b>	16	<b>#SN@</b>
5	<b>#SN5</b>	17	<b>#SNA</b>
6	<b>#SN6</b>	18	<b>#SNB</b>
7	<b>#SN7</b>	19	<b>#SNC</b>
8	<b>#SN8</b>	20	<b>#SND</b>
9	<b>#SN9</b>	21	<b>#SNE</b>
10	<b>#SN:</b>	22	<b>#SNF</b>
11	<b>#SN;</b>	23	<b>#SNG</b>
12	<b>#SN&lt;</b>	24	<b>#SNH</b>

8. Type **CF** to turn off Searam power to the Carousel. **Failure to send this command will drain the Searam batteries.**

Testing system firing of bottles in response to changes in pressure is more difficult, and requires connecting a variable pressure source to the SBE 9plus pressure port to simulate ocean pressure during downcast and upcast. **Do not use pressures greater than the capacity of the 9plus pressure sensor, or you will damage the pressure sensor.**

## Setup for Deployment

### Notes:

On the ship, cables longer than 3 meters should be installed inside an earthed metal conduit by a qualified electrician. This minimizes the potential for external signals to disrupt communication and ensures that high voltage lines (such as the sea cable) are sufficiently protected. Cables shorter than 3 meters can be used without shielding when installing or bench testing the instrument.

### Note:

It is always necessary to set date and then time.

Set the time and date, establish memory and auto fire parameters, and program and arm the auto fire before deployment:

1. Connect the Searam to the computer, start SeatermAF, and configure it for the Searam (see *Power and Communications Test* in *Section 3: Preparing Searam for Deployment*).
2. Click Connect SEARAM on the Toolbar to wake up the Searam and get an S> prompt.
3. **Set Up Searam:**
  - A. Set up the Searam and its interface with the *9plus*, after reviewing the information in this section on instrument commands.
  - B. Set the date and time in the format you desire. The commands are:
    - **MMDDYY=mmddy** set real-time clock month, day, year
    - **DDMMYY=ddmmy** set real-time clock day, month, year
    - **HHMMSS=hmmss** set real-time clock hour, minute, second**MMDDYY** and **DDMMYY** are equivalent; either can be used to set the date.
  - C. Click Status on the Toolbar to verify the setup.
4. **Program and Arm Auto Fire:**
  - A. Select *SBE 17plus V2 SEARAM with SBE 9plus* in the Configure menu. Make the desired selections on the Bottle Closure Logic and Bottle Closure Pressures tabs (see *Power and Communications Test* in *Section 3: Preparing Searam for Deployment*). Click OK to exit the Configuration Options dialog box.
  - B. Click Program on the Toolbar to send the bottle closure information from the Configuration Options dialog box to the Searam. SeatermAF sends a number of commands to the Searam, transmitting the bottle closure parameters in the format required by the Searam.
  - C. Click Closure Parameters SEARAM on the Toolbar to verify the auto fire parameters were entered and transmitted correctly to the Searam.
  - D. Click Arm on the Toolbar to arm the Searam, enabling the Searam to command the Carousel to take water samples.



## Deployment

### Note:

It is possible to use the Searam to record *9plus* data in memory at the same time as *9plus* data is transmitted real-time through the *11plus* V2 Deck Unit. This provides a data back-up in case there are data transmission problems over the sea cable. See the *9plus* manual for wiring and deployment details.

### CAUTIONS:

- **Do not use WD-40** or other petroleum-based lubricants, as they will damage the connectors.
- For wet-pluggable MCBH connectors: **Silicone lubricants in a spray can** may contain ketones, esters, ethers, alcohols, or glycols in their propellant. **Do not use these sprays, as they will damage the connector.**

1. By hand, unscrew the locking sleeve from the I/O (4-pin) bulkhead connector. **If you must use a wrench or pliers, be careful not to loosen the bulkhead connector instead of the locking sleeve.**
2. Remove the cable connector from the I/O bulkhead connector by pulling the cable connector firmly away from the bulkhead connector.
3. Install the dummy plug on the I/O bulkhead connector:
  - A. Lightly lubricate the inside of the dummy plug with silicone grease (DC-4 or equivalent).
  - B. **AG / XSG Connector** - Install the dummy plug, aligning the raised bump on the side of the plug with the large pin (pin 1 - ground) on the Searam. Remove any trapped air in the plug by *burping* or gently squeezing the plug near the top and moving your fingers toward the end cap. **OR**  
**MCBH Connector** – Install the dummy plug, aligning the pins.
  - C. Place the locking sleeve over the dummy plug. Tighten the locking sleeve finger tight only. **Do not overtighten the locking sleeve and do not use a wrench or pliers.**

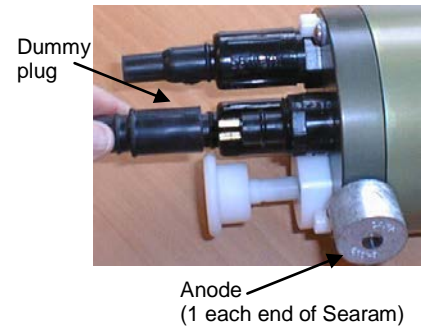
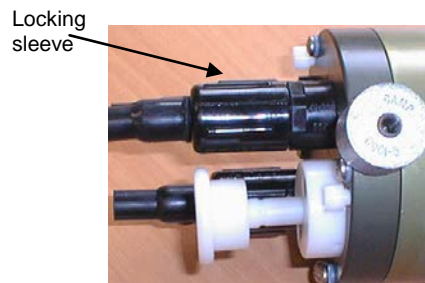

4. *Aluminum housing*: Verify that the anodes have not eroded away.
5. Verify that the hardware and external fittings are secure.
6. Verify that the cable connections from the Searam to the *9plus* and the Carousel are secure. If not, follow the procedure described in Steps 1 through 3 to remove and reinstall the cables.
7. Push in the Searam's switch plunger.

The Searam is ready to go in the water. Note that the *9plus* pump only runs when there is salt water in the conductivity cell.

### Note:

If powering the Searam externally (optional), install the SBE 17 junction box:

1. Connect the box to the Searam using the 4-pin to MS cable provided.
2. Connect the box to the computer serial port using the supplied cable.
3. Connect AC mains power.
4. Press the red power button to provide power to the Searam.

The junction box supplies approximately 17 volts, so Searam batteries will not be drawn down when the junction box is in use.

## Recovery

### **WARNING!**

**If the Searam, CTD, or Carousel stop working while underwater, are unresponsive to commands, or show other signs of flooding or damage, carefully secure the instruments away from people until you have determined that abnormal internal pressure does not exist or has been relieved.** Pressure housings may flood under pressure due to dirty or damaged o-rings, or other failed seals. When a sealed pressure housing floods at great depths and is subsequently raised to the surface, water may be trapped at the pressure at which it entered the housing, presenting a danger if the housing is opened before relieving the internal pressure. Instances of such flooding are rare. However, a housing that floods at 5000 meters depth holds an internal pressure of more than 7000 psia, and has the potential to eject the end cap with lethal force. A housing that floods at 50 meters holds an internal pressure of more than 85 psia; this force could still cause injury. If you suspect the Searam is flooded, point the Searam in a safe direction away from people, and loosen the 4 screws on the connector end cap about ½ turn. If there is internal pressure, the end cap will *follow* the screws out, and the screws will not become easier to turn. In this event, loosen 1 bulkhead connector very slowly, at least 1 turn. This opens an o-ring seal under the connector. Look for signs of internal pressure (hissing or water leak). If internal pressure is detected, let it bleed off slowly past the connector o-ring. Then, you can safely remove the end cap.

### Physical Handling

1. Rinse the Searam with fresh water.
2. If the batteries are exhausted, before data uploading:
  - Charge NiMH or Ni-Cad batteries, or
  - Install new alkaline batteries, or
  - Connect the Searam to an external power source.
 Stored data will not be lost as a result of exhaustion or removal of batteries. See *Section 5: Routine Maintenance* for battery charging or replacement.
3. By hand, unscrew the locking sleeve from the I/O bulkhead connector. **If you must use a wrench or pliers, be careful not to loosen the bulkhead connector instead of the locking sleeve.**
4. Remove the dummy plug from the I/O bulkhead connector by pulling the plug firmly away from the connector.
5. **XSG / AG Connector** - Install the I/O cable connector, aligning the raised bump on the side of the connector with the large pin (pin 1 - ground) on the Searam. **OR**  
**MCBH Connector** – Install the I/O cable connector, aligning the pins.
6. Connect the other end of the I/O cable to the computer serial port.

**Note:**

Set up **Upload Data** and **Header Information** (Step 2):

- The first time you upload data, and
- If you want to change upload or header parameters.

**Uploading Data**

1. Double click on the SeatermAF icon. The display shows the main screen.
2. In the Configure menu, select *SBE 17plus V2 SEARAM with SBE 9plus*. The Configuration Options dialog box appears. Click the Upload & Header Options tab. The dialog box looks like this:

Defines data upload type when using Upload on Toolbar or Upload menu:

- **All data separated by cast (default)** – All data uploaded. Separate file written for each cast, with 3-digit cast ID (001, etc.) appended to user-selected file name.
- **Single cast** – During upload, SeatermAF prompts for cast number, and uploads data from that cast into one file.
- **By cast number range** – During upload, SeatermAF prompts for beginning and ending cast numbers, and uploads data within range. Separate file written for each cast, with 3-digit cast ID (001, etc.) appended to user-selected file name.
- **All data as a single file** – All data uploaded into one file.
- **By scan number range** – During upload, SeatermAF prompts for beginning and ending scan (sample) numbers, and uploads all data within range into one file.

SeatermAF uploads CTD data in *blocks*, and calculates a checksum at end of each block. If block fails checksum verification, SeatermAF tries to upload block of data again, cutting block size in half. For *17plus V2*, default block size is 200 scans (samples).

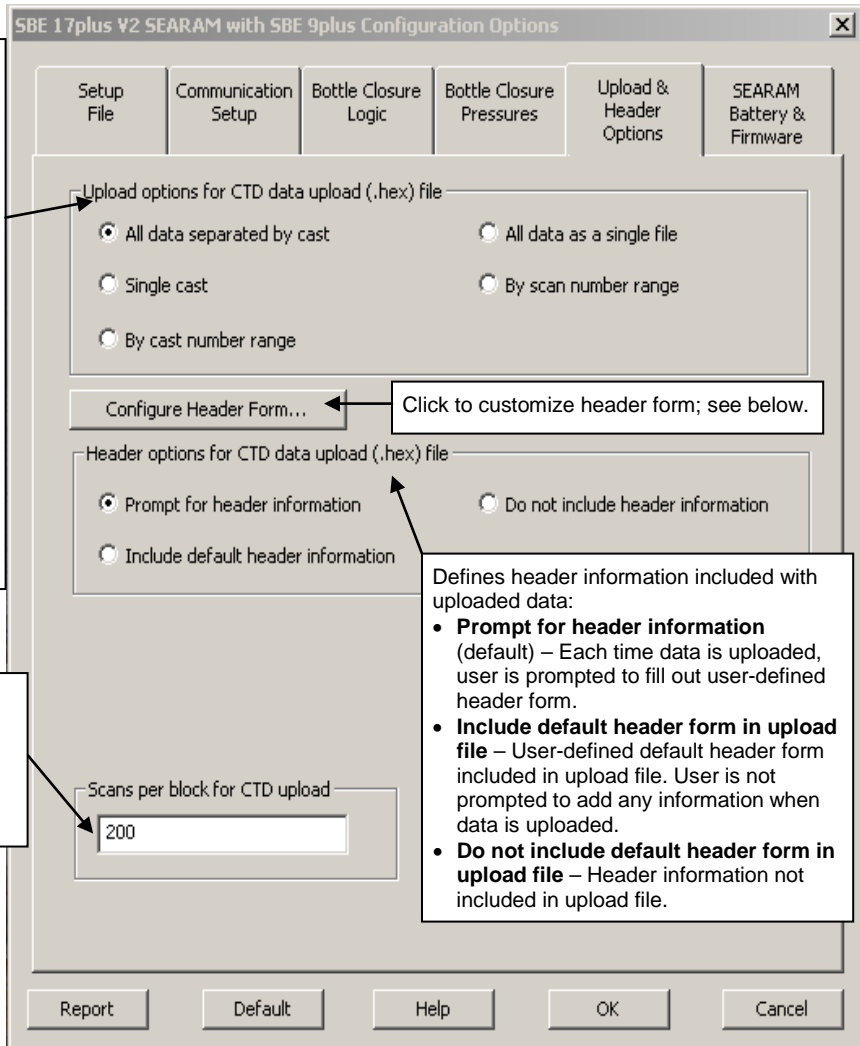

Defines header information included with uploaded data:

- **Prompt for header information (default)** – Each time data is uploaded, user is prompted to fill out user-defined header form.
- **Include default header form in upload file** – User-defined default header form included in upload file. User is not prompted to add any information when data is uploaded.
- **Do not include default header form in upload file** – Header information not included in upload file.

Click Configure Header Form to customize the header. The dialog box looks like this:

Header information: free form, 0 to 12 lines long. Defines:

- Header **prompts** that appear for user to fill in when uploading data, if *Prompt for header information* was selected on Upload & Header Options tab in Configuration Options dialog box
- Header included with uploaded data, if *Include default header form in upload file* was selected on Upload & Header Options tab in Configuration Options dialog box

Enter the desired header/header prompts. Click OK.

**Note:**

When exiting the program, SeatermAF prompts you to save the instrument settings to the .psa file if they have been modified. Alternatively, to save the settings to the .psa file while still in the Configuration Options dialog box, click on the Setup File tab and click Save or Save As.

Make the selections/enter data on the Upload & Header Options tab. Click OK to temporarily save the settings in the Configuration Options dialog box and to exit the dialog box.

3. Click Connect SEARAM on the Toolbar to begin communications with the Searam. The display looks like this:

```
SBE 17plus version 2 SEARAM 1.6
S>
```

This shows that correct communications between the computer and Searam has been established.

If the system does not respond as shown above:

- Click Connect SEARAM again to attempt to establish communications.
- Check cabling between the computer and Searam.
- Verify the correct instrument was selected and the serial port settings were entered correctly in the Configuration Options dialog box.

4. Display Searam status information by clicking Status on the Toolbar. The display looks like this:

```
S>ds
SBE17plus version 2 SEARAM V1.6 12/12/2013 12:30:43 batt type=NIMH
ncasts = 7 samples = 22128 free bytes= 16771072
number of frequency channels suppressed = 0
number of voltage channels suppressed = 0
number of scans averaged = 1
primary conductivity advanced 0 scans
secondary conductivity advanced 0 scans

Auto fire not armed
S>
```

5. If you have not already done so, command the Searam to stop logging by pulling out the switch plunger.
6. Click Upload on the Toolbar to upload stored data. SeatermAF responds as follows before uploading the data:
  - A. SeatermAF sends status (**DS**) and display headers (**DH**) commands, and displays the responses. These commands provide you with information regarding the number of scans and casts in memory.
  - B. If you selected *Single cast*, *By cast number range*, or *By scan number range* in the Configuration Options dialog box (Configure menu) – a dialog box requests the cast or range. Enter the desired value(s), and click OK.
  - C. If you selected *Prompt for header information* in the Configuration Options dialog box (Configure menu) – a dialog box with the header form appears. Enter the desired header information, and click OK.
  - D. In the Open dialog box, enter the desired upload file name and click OK (the upload file has a .hex extension). If you selected *All data separated by cast* or *By cast number range* in the Configuration Options dialog box (Configuration menu), SeatermAF automatically appends a 3-digit cast number (000 to 999) for each cast to the user-selected file name.
7. Ensure all data has been uploaded from the Searam by processing and reviewing the data in SBE Data Processing.

**Notes:**

To prepare the Searam for re-deployment:

1. Send **Erase Memory** to erase the memory and set the number of casts to 0, or send **SampleNum=0** or **CastNum=0** to reset the data pointers and cast numbers. If one of these commands is not sent, new data will be stored after the last recorded sample, preventing use of the entire memory capacity.
2. Push in the switch plunger to begin logging immediately, or send **QS** to put the Searam in quiescent (sleep) state until ready to redeploy.

## Processing Data Using SBE Data Processing

### Notes:

- *9plus* data uploaded from the Searam is in a .hex file. Real-time *9plus* data, acquired through an SBE 11*plus* Deck Unit with Seasave, is in one of the following file types:
  - Seasave versions < 6.0 saved data coming from the Deck Unit as a .dat file.
  - Seasave V7 (versions  $\geq 7.0$ ), save data coming from the Deck Unit as a .hex file.
- *Basic* instructions are provided for processing the data using SBE Data Processing. See the SBE Data Processing manual and/or Help files for details.

Sea-Bird provides software, SBE Data Processing, for converting the raw .hex data file into engineering units, editing (aligning, filtering, removing bad data, etc.) the data, calculating derived variables, and plotting the processed data.

A bottle confirm bit in the Searam's data file was set for all scans within a 1.5-second duration after each bottle fire confirmation was received by the Searam from the Carousel. SBE Data Processing can use this information to develop a separate water bottle file for comparison to physical testing of the water bottle samples.

Data uploaded from the Searam is processed in SBE Data Processing in several steps:

1. **Data Conversion** module – From the raw .hex file from the Searam, Data Conversion creates:
  - .cnv file – *9plus* data converted from raw hexadecimal to engineering units.
  - .ros water bottle file – data converted from raw hexadecimal to engineering units. The .ros file contains the *9plus* data for 1.5 seconds after each bottle firing as well as additional data for a user-selected range of scans before and after each bottle firing.
2. **Bottle Summary** module – The .ros file created by Data Conversion is processed by Bottle Summary, which creates a bottle data summary .btl file. The .btl file includes:
  - Bottle position, optional bottle serial number, and date and time.
  - User-selected derived variables, computed for each bottle from mean values of input variables (temperature, pressure, conductivity, etc.).
  - User-selected averaged variables, computed for each bottle from input variables.
3. Additional processing of .cnv data – align, filter, remove bad data, etc., calculate derived variables, and plot data using SBE Data Processing's other modules.

Verification of the instrument configuration (.xmlcon or .con) file, and the use of Data Conversion and Bottle Summary is described below (see the SBE Data Processing manual / help files for details).

**Notes:**

- Seasave and SBE Data Processing versions 7.20a introduced .xmlcon files (in XML format). SeatermAF is compatible with both .xmlcon and .con files.
- A new or recalibrated CTD ships with a configuration file that reflects the current configuration as *we know it*. The file is named with the instrument serial number, followed by a .xmlcon or .con extension. For example, for a CTD with serial number 2375, Sea-Bird names the file *2375.xmlcon*. You may rename the file (but not the extension) if desired; this will not affect the results.
- The Configuration file can also be viewed and modified in SeatermAF, by clicking Modify on the Setup File tab in the Configuration Options dialog box.

**Verifying Contents of Configuration (.xmlcon or .con) File**

Verify the contents of the configuration file by clicking 911/917plus in SBE Data Processing’s Configure menu, and then clicking Open in the dialog box to select the desired file. The configuration file defines the instrument – integrated auxiliary sensors, and channels, serial numbers, and calibration dates and coefficients for all the sensors (conductivity, temperature, and pressure as well as auxiliary sensors). SBE Data Processing uses the information in the .xmlcon or .con file to interpret and process the raw data. **If the configuration file does not match the actual instrument configuration, the software will not be able to interpret and process the data correctly.**

Channel/Sensor table reflects this choice; must be consistent with **SF=** programmed into Searam. Typically:

- **0** = SBE 3 or 4 plugged into JB5 (COND 2) on *9plus* (dual redundant sensor configuration)
- **1** = SBE 3 or 4 plugged into JB4 (TEMP 2) on *9plus* and not using JB5 (COND 2) connector (single redundant sensor configuration)
- **2** = no redundant T or C sensors

Channel/Sensor table reflects this choice; must be consistent with **SV=** programmed into Searam. Total voltage words is 4; each word contains data from two 12-bit A/D channels. Searam suppresses words starting with highest numbered word. Number of words to keep is determined by highest numbered external voltage input that is not a spare:  
 Words to suppress = 4 - Words to Keep

External Voltage (not spare) Connector	0 or 1 JT2(Aux1)	2 or 3 JT3(AUX2)	4 or 5 JT5(AUX3)	6 or 7 JT6(AUX4)
Words to Keep	1	2	3	4

Number of scans averaged in Searam; must be consistent with **Ave=** programmed into Searam. Example: If **Ave=24**, Searam averaged 24 scans, saving data to computer at 1 scan/second.

**NMEA data, Surface Par voltage, and Scan time added** are not applicable to *9plus* used with Searam.

Select SBE 17plus SEARAM.

Shaded sensors cannot be removed or changed to another type; others are optional.

Click a (non-shaded) sensor and click **Select** to pick a different sensor for that channel; dialog box with list of sensors appears. After sensor is selected, dialog box for calibration coefficients appears. Select sensors after *Frequency channels suppressed* and *Voltage words suppressed* have been specified above.

Click a sensor and click **Modify** to view/change calibration coefficients for that sensor.

## Data Conversion

In SBE Data Processing's Run menu, select Data Conversion. The input files for Data Conversion are the .hex file from the Searam and the CTD configuration file. The File Setup tab in the dialog box looks like this:

The screenshot shows the 'Data Conversion' dialog box with the 'File Setup' tab selected. The dialog has a menu bar (File, Options, Help) and several tabs (File Setup, Data Setup, Miscellaneous, Header View). The 'File Setup' tab contains the following fields and options:

- Program setup file:** K:/data/Debbie/DatCnv.psa. Buttons: Open..., Save, Save As..., Restore.
- Instrument configuration file:** K:\data\Debbie\test.con. Buttons: Select..., Modify...  Match instrument configuration to input file.
- Input directory:** K:\data\Debbie.
- Input files, 1 selected:** test.hex. Button: Select...
- Output directory:** K:\data\Debbie.
- Name append:** (empty field).
- Output file:** test.
- Not processing:** (empty field).

Callout boxes provide the following information:

- Location to store all information input in File Setup and Data Setup tabs:** Open to select a different .psu file, Save or Save As to save current settings, or Restore to reset all settings to match last saved version.
- Instrument configuration file location:** Select to pick a different .xmlcon or .con file, or Modify to view and/or modify instrument configuration.
- Directory and file names for raw data (.hex) from CTD:** Select to pick a different file. To process multiple raw data files from same directory: 1. Click Select. 2. In Select dialog box, hold down Ctrl key while clicking on each desired file.
- Match instrument configuration to input file:**
  - Select to have program find .xmlcon or .con file with same name and in same directory as data file. For example, if processing test.hex and this option is selected, program searches for test.xmlcon (same directory as test.hex); if it does not find test.xmlcon, it searches for test.con.
  - Also select if more than 1 data file is to be processed, and data files have different configuration files. For example, if processing test.hex and test1.hex, and this option is selected, program searches for test.xmlcon and test1.xmlcon (same directory as test.hex and test1.hex); if it does not find .xmlcon files, it searches for .con files.
- Directory and file names for converted output (.cnv) data:**
  - If more than 1 data file is to be processed, Output file field disappears and output file name is set to match input file name. For example, if processing test.hex and test1.hex, output files will be named test.cnv and test1.cnv.
  - SBE Data Processing adds Name append to (each) output file name, before .cnv extension. For example, if processing test.hex and test1.hex with a Name append of 06-20-00, output files will be test06-20-00.cnv and test106-20-00.cnv.

Buttons at the bottom: Start Process, Exit, Cancel.



The Data Setup tab in the dialog box looks like this:

**Data Conversion**  
File Options Help

File Setup | **Data Setup** | Miscellaneous | Header View

Process scans to end of file

Scans to skip over: 0

Scans to process: 1

Output format: ASCII output

Convert data from: Upcast and downcast

Create file types: Create both data and bottle file

Source of scan range data: Scans marked with bottle confirm bit

Scan range offset [s]: 0

Scan range duration [s]: 2

Merge separate header file

Select Output Variables...

Source for start time in output .cnv header:

Instrument's time stamp     System UTC  
 NMEA time     Upload time

Prompt for start time and/or note

Start Process    Exit    Cancel

**Callout Boxes:**

- Process scans to end of file:**
  - Program skips first scans to skip over scans.
  - If *Process scans to end of file* selected: process all remaining scans (upcast and downcast scans if *Upcast and downcast* selected; downcast scans only if *downcast* selected).
  - If *Process scans to end of file* not selected: process next scans to process.
- Scans to skip over / process:**
  - Binary - smaller file, processed faster than ASCII file by other SBE Data Processing modules.
  - ASCII - larger file, can be viewed with a text editor. Translate can translate converted data file from binary to ASCII or vice versa.
- Create file types:**
  - Create converted data file only, bottle file only (for subsequent processing by Bottle Summary), or both.
- Source of scan range data:**
  - Select *Scans marked with bottle confirm bit* as source of data for creating bottle file.
- Scan range offset / duration:**
  - Define scans from 9plus data file to be included in bottle file:
    - Offset* defines first scan output to .ros bottle file for each bottle, relative to first scan with bottle confirm bit set.
    - Duration* defines number of scans output to .ros bottle file for each bottle.
  - Example:** Data stored in Searam at full rate (24 scans/sec). Confirmation bit is set from scan 10,000 for 1.5 sec. If *offset* is -2 sec, and *duration* is 5 sec:  
 $10,000 - 2 \text{ sec offset (24 scans/sec)} = 9,952$   
 $9,952 + 5 \text{ sec duration (24 scans/sec)} = 10,072$   
 Therefore, scans 9,952 through 10,072 will be written to .ros file.

- Source for start time in output .cnv header:**
- Select start time source for header:
  - Instrument's time stamp – instrument's time stamp in first data scan (if available) or in header of input raw data file.
  - NMEA time – Not applicable with Searam.
  - System UTC – computer time in first data scan (if available) or in header of input raw data file.
  - Upload time – time that data was uploaded from instrument's memory.
- Start Process:**
- Begin processing data. Status field on File Setup tab shows *Processing complete* when done.
- Exit:**
- Return to SBE Data Processing window.
  - If *Confirm Program Setup Change* was selected in Options menu - If you made changes and did not Save or Save As, program asks if you want to save changes.
  - If *Confirm Program Setup Change* was not selected in Options menu - Button says **Save & Exit**. If you do not want to save changes, use Cancel button to exit.

The Select Output Variables dialog box (which appears when you click **Select Output Variables** on the Data Setup tab) looks like this:

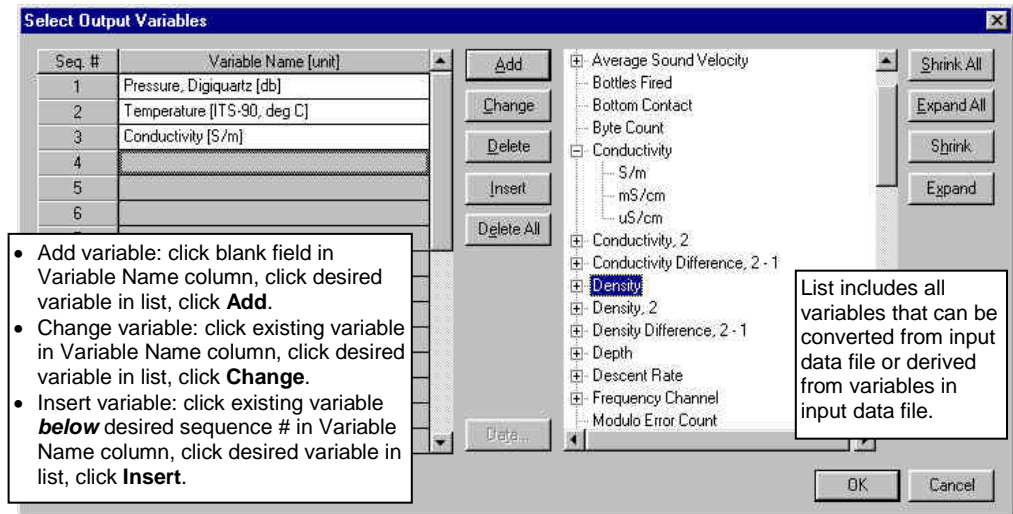

**Output variables selected here will be put in both the .cnv and .ros files.**

## Bottle Summary

In SBE Data Processing's Run menu, select Bottle Summary. The File Setup tab in the dialog box is similar to the one shown and described for Data Conversion above. The input files for Bottle Summary are the .ros file (created in Data Conversion) and the CTD configuration (.xmlcon or .con) file.

- Additionally, if a .sn file (same name as input .ros file, with .sn extension) is found in the input file directory, bottle serial numbers are inserted between the bottle position and date/time columns in the .bt1 file output. The format for the .sn file is:  
Bottle position, serial number (with a comma separating the two fields)

**Note:**

You can create a .sn file in a text editor.

The Data Setup tab in the dialog box looks like this:

**File Setup** | **Data Setup** | Header View

Output min/max values for averaged variables

Select Averaged Variables...

Select Derived Variables...

Oxygen

Apply Tau correction

Start Process      Exit      Cancel

Select input variables to be averaged. Mean and standard deviation will be calculated and output for each bottle.

- If *Output min/max values for averaged variables* is selected, minimum and maximum values will also be output for each bottle.

Ignored if not computing oxygen in derived variables:  
Tau correction ( $[\tau(T,P) * \delta V / \delta t]$  in SBE 43 or  $[\tau * doc/dt]$  in SBE 13 or 23) improves response of measured signal in regions of large oxygen gradients. However, this term also amplifies residual noise in signal (especially in deep water), and in some situations this negative consequence overshadows gains in signal responsiveness.

Select variables to derive from input data. Derived variables are computed from mean values of input variables (temperature, conductivity, pressure, etc.) for each bottle.

- Oxygen can be derived if oxygen data (oxygen current and temperature for SBE 13 or 23; oxygen signal for SBE 43) is in the .ros file. Bottle Summary calculates derivative of oxygen current (or signal), using a least squares fit to all the oxygen data for each bottle. Oxygen is calculated using mean values for temperature, pressure, and salinity, derivative, and scan-by-scan values of oxygen current and temperature (or signal).

## Other Processing Modules

See the SBE Data Processing manual / Help files for information on additional processing that can be performed on the converted CTD data (.cnv) file.

## Editing Raw Data File

Sometimes users want to edit the raw .hex data file before beginning processing, to remove data at the beginning of the file corresponding to instrument *soak* time, to remove blocks of bad data, to edit the header, or to add explanatory notes about the cast. **Editing the raw .hex file can corrupt the data, making it impossible to perform further processing using Sea-Bird software.** Sea-Bird strongly recommends that you first convert the data to a .cnv file (using the Data Conversion module in SBE Data Processing), and then use other SBE Data Processing modules to edit the .cnv file as desired.

The procedure for editing a .hex data file described below has been found to work correctly on computers running Windows 98, 2000, and NT. **If the editing is not performed using this technique, SBE Data Processing may reject the edited data file and give you an error message.**

### Note:

Although we provide this technique for editing a raw .hex file, **Sea-Bird's strong recommendation, as described above, is to always convert the raw data file and then edit the converted file.**

1. **Make a back-up copy of your .hex data file before you begin.**
2. Run **WordPad**.
3. In the File menu, select Open. The Open dialog box appears. For *Files of type*, select *All Documents (\*.\*)*. Browse to the desired .hex data file and click Open.
4. Edit the file as desired, **inserting any new header lines after the System Upload Time line**. All header lines must begin with an asterisk (\*), and \*END\* indicates the end of the header. An example is shown below, with the added lines in bold:

```
* Sea-Bird SBE17 Data File:
* FileName = C:\term17af\cast000.hex
* Software Version 5.0
* Temperature SN =
* Conductivity SN =
* System UpLoad Time = Aug 17 2004 3:45:12 PM
* Testing adding header lines
* Must start with an asterisk
* Place anywhere between System Upload Time & END of header
* ds
* SBE17plus SEARAM V1.4 08/17/2004 15:47:26 batt type = NICAD
* ncasts = 6 samples = 541078 free bytes = 16777216
* number of frequency channels suppressed = 0
* number of voltage channels suppressed = 0
* number of scans averaged = 1
* primary conductivity advanced 0 scans
* secondary conductivity advanced 0 scans
* Auto fire not armed

* S>
* dh
* cast 0 08/05/2004 10:36:34 avg = 1 nfs = 0 nvs = 0 smpls 0 to
163 stop = switch off v = 15.4
* S>

*END*
```

5. In the File menu, select Save (**not Save As**). If you are running Windows 2000, the following message displays:

You are about to save the document in a Text-Only format, which will remove all formatting. Are you sure you want to do this?

Ignore the message and click *Yes*.

6. In the File menu, select Exit.

# Section 5: Routine Maintenance

This section reviews corrosion precautions, connector maintenance, battery charging, battery replacement, and O-ring maintenance.

---

## Corrosion Precautions

Rinse the Searam with fresh water after use and prior to storage.

### Aluminum Housing

All stainless steel screws which are exposed to salt water have been generously lubricated at the factory with Blue Moly™. After each use, remove these screws and re-lubricate them. **This compound is electrically conductive, so use care to ensure it does not get on circuit boards.**

There is a large zinc anode screwed in each end cap. Check these anodes periodically to verify that they are securely fastened and have not been eaten away.

### Titanium Housing

All exposed metal is titanium; other materials are plastic. No corrosion precautions are required, but direct electrical connection of the Searam housing to dissimilar metal hardware should be avoided.

---

## Connector Mating and Maintenance

**Note:**

See *Application Note 57: Connector Care and Cable Installation*.

Clean and inspect connectors, cables, and dummy plugs before every deployment and as part of your yearly equipment maintenance. Inspect connectors that are unmated for signs of corrosion product around the pins, and for cuts, nicks or other flaws that may compromise the seal.

**CAUTIONS:**

- **Do not use WD-40** or other petroleum-based lubricants, as they will damage the connectors.
- For wet-pluggable MCBH connectors: **Silicone lubricants in a spray can** may contain ketones, esters, ethers, alcohols, or glycols in their propellant. **Do not use these sprays, as they will damage the connector.**

When remating:

1. Lightly lubricate the inside of the cable/dummy plug connector with silicone grease (DC-4 or equivalent).
2. **AG / XSG Connector** - Install the cable/dummy plug connector, aligning the raised bump on the side of the connector with the large pin (pin 1 - ground) on the Searam. Remove any trapped air by *burping* or gently squeezing the connector near the top and moving your fingers toward the end cap. **OR**  
**MCBH Connector** – Install the cable/dummy plug connector, aligning the pins.
3. Place the locking sleeve over the cable/dummy plug connector. Tighten the locking sleeve finger tight only. **Do not overtighten the locking sleeve and do not use a wrench or pliers.**

Verify that a cable or dummy plug is installed on each connector before deployment.

## Replacing/Recharging Batteries

### Note:

If changing from NiMH to alkaline or Ni-Cad batteries, or vice versa, send **BatteryType=** to indicate the new battery type.

Leave the batteries in place when storing the Searam. If the Searam is to be stored for long periods, **replace alkaline batteries yearly to prevent battery leakage** (which could damage the Searam).

### Recharging NiMH Batteries

See the *NiMH Battery Charger and Battery Pack* manual for complete details on charging, error messages, battery specifications, etc.

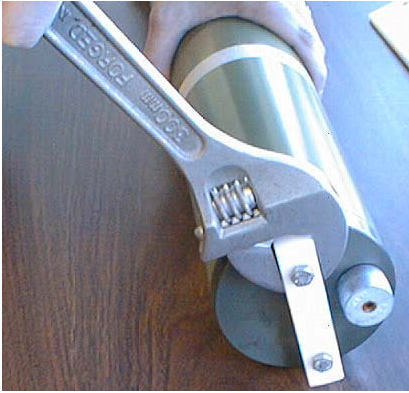

1. Remove the battery end cap:
  - A. Wipe the outside of the battery end cap (end cap without any connectors) and housing dry, being careful to remove any water at the seam between them.
  - B. Using a wrench on the white plastic bar, unthread the end cap, rotating counter-clockwise.
  - C. Remove any water from the O-ring mating surfaces inside the housing with a lint-free cloth or tissue.
  - D. Put the end cap aside, being careful to protect the O-ring from damage or contamination.

### Note:

**If desired, you can recharge the battery pack while it is in the housing.** Skip Steps 2 and 4 if recharging in the housing.

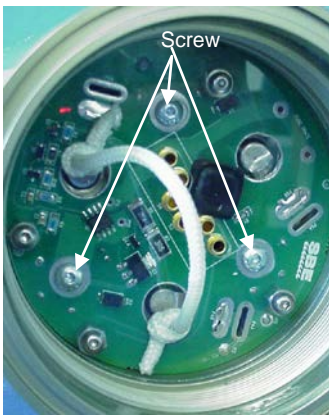

Battery pack

2. Remove the battery pack from the housing:
  - A. The protective plastic plate over the battery cover plate prevents you from completely removing the cap screws that connect the battery pack to the Searam battery posts in one step. Each of the screws is 12 mm (1/2 inch) long, but the clearance between the cover plate and plastic plate is only 6 mm (1/4 inch). Unscrew each of the three cap screws **just until they hit the bottom of the protective plastic plate**. The battery pack will *walk* out of the housing approximately 6 mm (1/4 inch) because of the spring contacts at the bottom of the battery compartment. Unscrew the cap screws again. The battery pack will *walk* out of the housing again, and should now be disconnected from the battery posts.
  - B. Pull on the cord to remove the battery pack from the housing.

**WARNING!**

Do not disconnect the battery while the Charger Active lamp is on. Doing so may cause a small spark.

**Note:**

The NiMH battery pack fits tightly in the Searam housing. When placing a battery pack in the Searam, align it carefully and slowly insert it straight into the housing. If not careful, the battery pack shrink wrap can be torn.

**CAUTION:**

Do not use Parker O-Lube, which is petroleum based; use only Super O-Lube.

3. Recharge the batteries:
  - A. Plug the battery charger into a suitable power source and turn on power to the charger.
  - B. Connect the charger cable to the battery pack and charger. The LED should show **READY**, and display the battery type and measured voltage.
  - C. Press the **Discharge** button. The LED should show **DISCHARGE**. This starts the discharge cycle, which discharges any remaining battery capacity. Repeatedly charging without discharging may damage the battery pack. The Discharge cycle takes approximately 75 minutes. When discharging is complete, the LED should show **EMPTY**.
  - D. Press the **Charge** button. The LED should show **Fast Charge** (it may also show **WARM-UP CHARGE**, **REFILL CHARGE**, and/or **TOP OFF** during the charge cycle). The Charge cycle takes approximately 2 hours. When charging is complete, the LED should show **BATTERY FULL**.
  - E. Turn off power to the charger.
  - F. Disconnect the battery pack from the charger and the charger from the power source.
4. Reinstall the battery pack in the housing:
  - A. Align the battery pack with the housing. The posts inside the housing are not placed symmetrically, so the battery pack fits into the housing only one way. Looking at the bottom of the battery pack, note that one tube is closer to the edge than the others, corresponding to the post that is closest to the housing.
  - B. Reinstall the three cap screws until they are snug against the top plate. While pushing hard on the protective plastic plate to depress the spring contacts at the bottom of the compartment, continue to tighten the cap screws. Repeat until all three cap screws are tightened and the battery pack cannot be pushed further into the housing. **The screws must be fully tightened, or battery power to the circuitry will be intermittent.**
5. Reinstall the battery end cap:
  - A. Remove any water from the O-rings and mating surfaces with a lint-free cloth or tissue. Inspect the O-rings and mating surfaces for dirt, nicks, and cuts. Clean or replace as necessary. Apply a light coat of O-ring lubricant (Parker Super O Lube) to O-ring and mating surfaces.
  - B. Carefully fit the end cap into the housing and rethread the end cap into place. Use a wrench on the white plastic bar to ensure the end cap is tightly secured.
6. Verify that the switch plunger on the top end cap is pulled out, so the Searam will be in quiescent (sleep) state.

## Recharging Ni-Cad Batteries

Note: Ni-Cad battery pack and charger are no longer available.

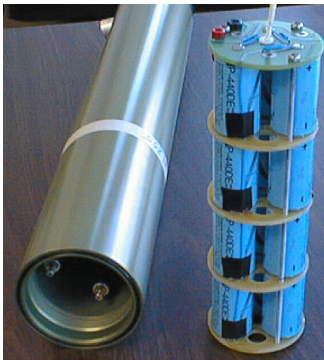
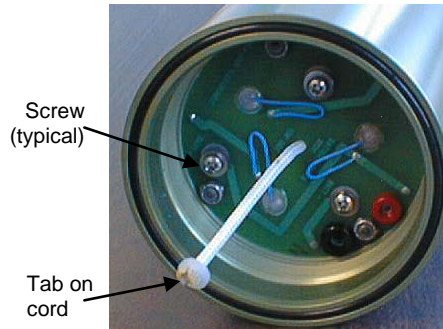

**CAUTION:**

**Do not recharge the battery pack while it is in the housing.** If you do so, you may damage the Searam electronics.

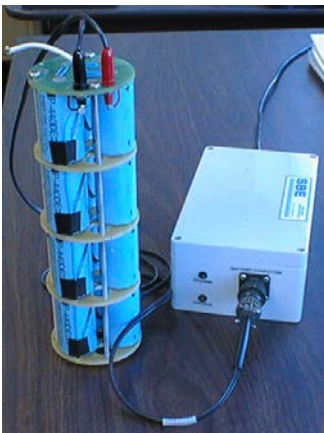

1. Remove the battery end cap:
  - A. Wipe the outside of the battery end cap (end cap without any connectors) and housing dry, being careful to remove any water at the seam between them.
  - B. Using a wrench on the white plastic bar, unthread the end cap, rotating counter-clockwise.
  - C. Remove any water from the O-ring mating surfaces inside the housing with a lint-free cloth or tissue.
  - D. Put the end cap aside, being careful to protect the O-ring from damage or contamination.
  
2. Remove the battery pack from the housing:
  - A. Remove the three Phillips-head machine screws and washers from the battery cover plate inside the housing.
  - B. Pull on the plastic tab on the center cord to remove the battery pack from the housing.
  
3. Recharge the batteries:
  - A. Connect the battery charger leads to the battery cover pin jacks, matching black-to-black and red-to-red (the pin jacks are different sizes to prevent cross-wiring).
  - B. Plug the battery charger into a suitable AC mains power source.
  - C. The red **Charge** LED on the charger comes on. Recharging takes approximately 15 hours. When recharging is complete, the yellow **Trickle** LED comes on, indicating the charger is providing a maintenance level charge.
  - D. Disconnect the battery pack from the charger and the charger from the power source.
  - E. Check the voltage at BAT + and BAT – on the battery cover. It should be approximately 14.4 volts.



4. Reinstall the battery pack in the housing:
  - A. Align the battery pack with the housing. The posts inside the housing are not placed symmetrically, so the battery pack fits into the housing only one way. Looking at the battery bottom cover, note that one circular cutout is closer to the edge than the others, corresponding to the post that is closest to the housing.
  - B. Reinstall the three Phillips-head screws and washers, while pushing hard on the top of the battery pack to depress the spring contacts at the bottom of the compartment. **The screws must be fully tightened, or the battery power to the circuitry will be intermittent.**
5. Reinstall the battery end cap:
  - A. Remove any water from the O-rings and mating surfaces with a lint-free cloth or tissue. Inspect the O-rings and mating surfaces for dirt, nicks, and cuts. Clean or replace as necessary. Apply a light coat of O-ring lubricant (Parker Super O Lube) to O-ring and mating surfaces.
  - B. Carefully fit the end cap into the housing and rethread the end cap into place. Use a wrench on the white plastic bar to ensure the end cap is tightly secured.
6. Verify that the switch plunger on the top end cap is pulled out, so the Searam will be in quiescent (sleep) state.

**CAUTION:**

**Do not use Parker O-Lube, which is petroleum based; use only Super O-Lube.**

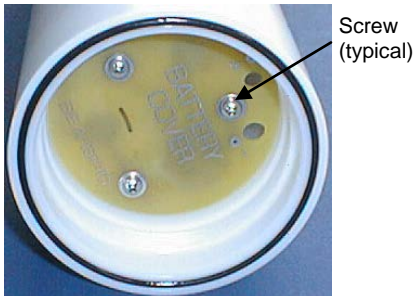

### Replacing Alkaline Batteries

1. Access the battery compartment:
  - A. Wipe the outside of the battery end cap (end cap without any connectors) and housing dry, being careful to remove any water at the seam between them.
  - B. Using a wrench on the white plastic bar, unthread the end cap, rotating counter-clockwise.
  - C. Remove any water from the O-ring mating surfaces inside the housing with a lint-free cloth or tissue.
  - D. Put the end cap aside, being careful to protect the O-ring from damage or contamination.
2. Remove the battery cover from the housing:
  - A. Remove the three Phillips-head screws and washers from the battery cover plate inside the housing.
  - B. The battery cover will pop out. Put it aside.
3. Turn the Searam over and remove the batteries. Install the new batteries, with the + terminal against the flat battery contacts and the - terminal against the spring contacts.

**CAUTION:**

The Searam has no clamp or voltage drop circuitry to limit the supply voltage to the SBE 9plus. Thus, the voltage supplied by the Searam's power supply is the voltage supplied to the 9plus, which is also the voltage supplied by the 9plus to all its auxiliary sensors. Some auxiliary voltage sensors, such as WET Labs ECO sensors, are limited to input voltages less than 15 volts. Twelve fully charged batteries in the Searam supply the following voltage:

- NiMH or Ni-Cad - 14.4 volts
- **Alkaline - 18 volts**

**Using alkaline batteries in the Searam for 9plus deployments including lower input voltage sensors can damage the sensors.**

**CAUTION:**

**Do not use Parker O-Lube, which is petroleum based; use only Super O-Lube.**

4. Reinstall the battery cover in the housing:
  - A. Align the battery cover with the housing. The posts inside the housing are not placed symmetrically, so the cover fits into the housing only one way. Looking at the cover, note that one screw hole is closer to the edge than the others, corresponding to the post that is closest to the housing.
  - B. Reinstall the three Phillips-head screws and washers, while pushing hard on the battery cover to depress the spring contact. **The screws must be fully tightened, or the battery power to the circuitry will be intermittent.**
5. Check the battery voltage at BAT + and BAT - on the battery cover. It should be approximately 18 volts.
6. Reinstall the battery end cap:
  - A. Remove any water from the O-rings and mating surfaces with a lint-free cloth or tissue. Inspect the O-rings and mating surfaces for dirt, nicks, and cuts. Clean as necessary. Apply a light coat of O-ring lubricant (Parker Super O Lube) to O-ring and mating surfaces.
  - B. Carefully fit the end cap into the housing and rethread the end cap into place. Use a wrench to ensure the cap is tightly secured.
7. Verify that the switch plunger on the top end cap is pulled out, so the Searam will be in quiescent (sleep) state.

---

## O-Ring Maintenance

**Note:**

For details on recommended practices for cleaning, handling, lubricating, and installing O-rings, see the *Basic Maintenance of Sea-Bird Equipment* module in the Sea-Bird training materials on our website.

**CAUTION:**

**Do not use Parker O-Lube, which is petroleum based; use only Super O-Lube.**

Recommended inspection and replacement schedule:

- For battery end cap O-rings – inspect each time you open the housing to replace the batteries; replace approximately once a year.
- For O-rings that are not normally disturbed (for example, on the connector end cap) - approximately every 3 to 5 years.

Remove any water from the O-rings and mating surfaces in the housing with a lint-free cloth or tissue. Inspect O-rings and mating surfaces for dirt, nicks, and cuts. Clean or replace as necessary. Apply a light coat of O-ring lubricant (Parker Super O Lube) to O-rings and mating surfaces.

# Glossary

**Battery pack** – Battery pack assembly includes twelve D-cell (nominal 8 Amp-hour) rechargeable Nickel Metal Hydride (NiMH) batteries (alkaline batteries or rechargeable Ni-Cad batteries can be substituted).  
Note: Ni-Cad battery pack and charger are no longer available.

**Carousel Water Sampler** – Sea-Bird’s SBE 32.

**Searam** – SBE 17plus V2 memory and auto fire module for use with any SBE 9plus CTD unit to permit *in-situ* recording of CTD data without the need for conductive wire and a slip-ring equipped winch.

**PCB** – Printed Circuit Board.

**Note:**

All Sea-Bird software listed was designed to work with a computer running Windows XP service pack 2 or later, Windows Vista, or Windows 7 (32-bit or 64-bit).

**SBE Data Processing** – Sea-Bird’s Windows data processing software, which calculates and plots temperature, conductivity, pressure, auxiliary sensor parameters, and derived variables such as salinity and sound velocity.

**Scan** – One data sample containing temperature, conductivity, pressure, and optional auxiliary sensor data.

**Seasoft V2** –Sea-Bird’s complete Windows software package, which includes software for communication, real-time data acquisition, and data analysis and display. Seasoft V2 includes **SeatermAF** and **SBE Data Processing**.

**SeatermAF V2** – Sea-Bird’s Windows software used to communicate with the Searam. SeatermAF can send commands to the Searam to provide status display, data acquisition and auto fire setup, data display and capture, data upload, and diagnostic tests.

**CAUTION:**

**Do not use Parker O-Lube, which is petroleum based; use only Super O-Lube.**

**Super O-Lube** – Silicone lubricant used to lubricate O-rings and O-ring mating surfaces. Super O-Lube can be ordered from Sea-Bird, but should also be available locally from distributors. Super O-Lube is manufactured by Parker Hannifin ([www.parker.com/ead/cm2.asp?cmid=3956](http://www.parker.com/ead/cm2.asp?cmid=3956)).

# Appendix I: Functional Description

Searam circuitry is contained on one PCB:

- **Battery Wiring and Power Supply**  
Searam's main battery is 12 D-cells. The positive battery connections are contact areas on double-thick printed circuit disks that form the internal bulkhead and battery retainer plates. Battery negative contacts are heavy beryllium-copper springs.  
When the battery-circuit card connection is made, a low-power regulator chip supplies 5 volts (+ 5C) to the wake-up circuits. When a character is received from the RS-232 interface or the magnetic reed switch plunger is pushed in, the CPU powers on by switching on Q3 and Q5. The CPU checks that main battery voltage is adequate (minimum 10 volts at the input of Q3 and Q5) before proceeding.
- **9plus Power Supply**  
MOSFET Q1 switches 9plus power to the unregulated +15 volt supply of the 9plus.
- **9plus Receiver**  
The microcontroller U12 decodes serial data from the 9plus.
- **Carousel Power Supply**  
MOSFET Q9 switches Carousel power to the unregulated +15 volt supply of the Carousel.
- **A/D Converter (Internal Diagnostics)**  
A 12-bit A/D converter measures main supply voltage and operating current.
- **CPU and Data I/O**  
Searam's CPU is configured around a CMOS 16-bit microprocessor (U19), with program storage in CMOS EPROM. Communication with the Searam is via RS-232 interface to the UART (U23), while level conversion is handled by U14.
- **Real-Time Clock**  
Real-time clock functions are provided by U15.
- **Memory**  
Two 8 MB FLASH RAM chips (U20 and 21) provide main data memory.

# Appendix II: Electronics Disassembly/Reassembly

Jackscrew kit



Sea-Bird provides a jackscrew kit with the Searam, to assist in removal of the connector end cap. The kit contains:

- 2 Allen wrenches
- 3 jackscrews
- 2 spare plastic socket hex-head screws

## Disassembly

### Note:

Wire (not shown) connects plunger to grounding strap to prevent accidental loss of plunger.

Do not remove this screw.  
Remove plastic hex head screws and install jackscrews in their place.



Remove 4 Phillips-head screws.



Detach wires at connector on PCB

Remove the connector end cap and attached electronics PCB assembly as follows:

1. Wipe the outside of the end cap and housing dry, being careful to remove any water at the seam between them.
2. Remove the four Phillips-head screws securing the end cap to the housing. Do not remove the fifth screw, which is an electrical connector.
3. Remove the three plastic hex head screws from the end cap using the larger Allen wrench. Insert the three jackscrews in these three holes in the end cap. When you begin to feel resistance, use the smaller Allen wrench to continue turning the screws. Turn each screw ½ turn at a time. As you turn the jackscrews, the end cap will push away from the housing. When the end cap is loosened, pull it and the PCB assembly out of the housing. Wires from the electronics are connected to the bottom of the electronics compartment – do not tear these connections out when removing the end cap.
4. Remove any water from the O-ring mating surfaces inside the housing with a lint-free cloth or tissue. Protect the O-ring from damage or contamination.
5. The electronics are electrically connected to the bottom of the electronics compartment with a 3-pin Molex connector on the PCB. Holding the wire cluster near the connector, gently detach the connector from the pins.
6. Remove the jackscrews from the end cap.

## Reassembly

**Note:**

Before delivery, a desiccant package is inserted in the housing and the electronics chamber is filled with dry Argon gas. These measures help prevent condensation. To ensure proper functioning:

1. Install a new desiccant bag each time you open the electronics chamber. If a new bag is not available, see *Application Note 71: Desiccant Use and Regeneration (drying)*.
2. If possible, dry gas backfill each time you open the housing. If you cannot, wait at least 24 hours before redeploying, to allow the desiccant to remove any moisture from the housing.

Note that opening the battery compartment does not affect desiccation of the electronics.

**CAUTION:**

**Do not use Parker O-Lube, which is petroleum based; use only Super O-Lube.**

1. Reinstall the end cap:
  - A. Remove any water from the O-ring and mating surfaces with a lint-free cloth or tissue. Inspect the O-ring and mating surfaces for dirt, nicks, and cuts. Clean or replace as necessary. Apply a light coat of O-ring lubricant (Parker Super O Lube) to O-ring and mating surfaces.
  - B. Plug the 3-pin Molex connector onto the pins on the PCB.
  - C. Carefully fit the end cap into the housing, aligning the holes in the end cap and housing, until the O-ring is fully seated.
  - D. Reinstall the four Phillip-head screws to secure the end cap.
  - E. Reinstall the 3 plastic hex head screws in the end cap.
  
2. Verify that the switch plunger on the top end cap is pulled out, so the Searam will be in quiescent (sleep) state.

# Appendix III: Command Summary

FUNCTION	COMMAND	DESCRIPTION
Status	DS	Display operating status.
	CP	Display bottle closure parameters.
General Setup	MMDDYY= mmddy	Set real-time clock month, day, year. Follow with HHMMSS= or it will not set date.
	DDMMYY= ddmmy	Set real-time clock day, month, year. Follow with HHMMSS= or it will not set date.
	HHMMSS= hhmss	Set real-time clock hour, minute, second.
	Baud=x	x= baud rate for general communication and uploading (300, 600, 1200, 2400, 4800, 9600, 19200, or 38400)
	BatteryType=x	x=nimh: Set battery type to NiMH. x=nicad: Set battery type to Ni-Cad. (Note: Ni-Cad battery pack and charger are no longer available.) x=alkaline: Set battery type to alkaline.
	SampleNum=0 * or CastNum= 0 *	Initialize logging – use to reset data pointers and cast number <b>after existing data has been removed from Searam</b> and prior to recording new data. Sending <i>either</i> sets both <b>SampleNum</b> and <b>CastNum</b> to 0. When switch plunger is pushed in, recording begins immediately. First time switch is pushed in after receipt of <b>SampleNum=0</b> or <b>CastNum=0</b> , data recording starts at beginning of memory and any previously recorded data is written over, whether memory has been erased ( <b>Erase Memory</b> ) or not. When switch is pulled out, recording stops. Each time switch is pushed in again, recording continues with new data stored after previously recorded data and a new header written to indicate time, date, incremented cast number, and sample numbers contained in cast. Up to 100 casts may be taken or until memory is full.
	Erase Memory *	Erase memory, <b>destroying all data in Searam</b> . All data bits are set to 1; sample number, header number, and data pointers are set to 0. Erasing memory is optional, as Searam writes over previously recorded information when <b>SampleNum=0</b> or <b>CastNum=0</b> is used. Knowledge of initial memory contents (i.e., all 1's) can be a useful cross check when data is uploaded.
	QS	Quit session and place Searam in quiescent (sleep) state. Main power is turned off; memory retention is unaffected. (Searam automatically enters quiescent state after 2 minutes have elapsed without receiving a command.)

FUNCTION	COMMAND	DESCRIPTION												
<b>SBE 9plus Setup</b>	<b>Ave=x</b>	<b>x</b> = number of scans to average in Searam (1 to 96). Averaging reduces data storage requirements, but also reduces measurement resolution.												
	<b>SF=x</b>	<b>x</b> = number of 9plus frequency channels to suppress in Searam. Unused channels are not stored in memory. <b>x</b> = 0 if SBE 3 or 4 connected to JB5 on 9plus bottom end cap connector (dual redundant sensor configuration). <b>x</b> = 1 if SBE 3 or 4 connected to JB4 on 9plus bottom end cap connector and not using JB5 (single redundant sensor configuration). <b>x</b> = 2 if not using redundant sensors.												
	<b>SV=x</b>	<b>x</b> = number of 9plus voltage channels to suppress in Searam ( <b>x</b> = 0, 2, 4, 6, or 8). Unused channels are not stored in memory. Searam can suppress voltage channels above highest numbered channel being used. <table border="1"> <thead> <tr> <th>Connector</th> <th>Uses Channels</th> <th>Connector</th> <th>Uses Channels</th> </tr> </thead> <tbody> <tr> <td>JT2 (AUX1)</td> <td>0 and 1</td> <td>JT5 (AUX3)</td> <td>4 and 5</td> </tr> <tr> <td>JT3 (AUX2)</td> <td>2 and 3</td> <td>JT6 (AUX4)</td> <td>6 and 7</td> </tr> </tbody> </table>	Connector	Uses Channels	Connector	Uses Channels	JT2 (AUX1)	0 and 1	JT5 (AUX3)	4 and 5	JT3 (AUX2)	2 and 3	JT6 (AUX4)	6 and 7
	Connector	Uses Channels	Connector	Uses Channels										
	JT2 (AUX1)	0 and 1	JT5 (AUX3)	4 and 5										
	JT3 (AUX2)	2 and 3	JT6 (AUX4)	6 and 7										
	<b>AC0=x</b>	<b>x</b> = number of 9plus scans ( <b>x</b> =0 - 3) to advance <i>primary</i> conductivity to align conductivity and temperature data.												
<b>AC1=x</b>	<b>x</b> = number of 9plus scans ( <b>x</b> =0 - 3) to advance <i>secondary</i> conductivity to align conductivity and temperature data.													
<b>Fx</b>	Turn Searam power to 9plus power on/off, instead of using Searam's switch plunger. <b>x=O</b> : turn power to 9plus on. <b>x=F</b> : turn power to 9plus off.													
<b>Carousel Setup</b>	<b>Cx</b>	<b>x=O</b> : Turn Searam power to Carousel on. <b>x=F</b> : Turn Searam power to Carousel off.												
	<b>#xxx</b>	Relay character string defined by <b>xxx</b> to Carousel. <b>xxx</b> can be any command recognized by Carousel – see Carousel manual for list of commands.												
<b>Auto Fire Arm/Disarm</b> Arm before launching to take water samples. Disarm to log data but not take water samples.	<b>Arm</b>	Arm (enable) auto fire.												
	<b>Disarm</b>	Disarm (disable) auto fire.												
<b>Data Upload</b> Pull out switch plunger before uploading data.	<b>DC [x]</b>	Display raw data in hex from cast <b>x</b> . If <b>x</b> omitted, data from cast 0 displays.												
	<b>DD [x1,x2]</b>	Display raw data in hex from scan <b>x1</b> through <b>x2</b> . If <b>x1</b> and <b>x2</b> omitted, data from every scan displays.												
	<b>DH</b>	Display all headers.												
<b>Diagnostics</b>	<b>BV</b>	Display Searam main battery voltage.												
	<b>BI</b>	Display Searam main battery current (amps).												
	<b>VR</b>	Continuously display Searam voltages – main battery voltage and operating current (amps). Searam switches on power to 9plus and Carousel, so operating current is total current drawn by Searam, 9plus, and Carousel. Press Esc key to stop test.												
	<b>TestEE</b>	Test Searam EEPROM.												
	<b>Flash Initialize *</b>	Perform memory test, <b>destroying all data in Searam</b> . Maps bad data blocks, allowing Searam to avoid using those blocks when recording data. Requires approximately 20 minutes, and cannot be stopped once it begins.												
	<b>Flash Map</b>	Display results of mapping from <b>Flash Initialize</b> . Press Esc key to abort at any time.												

**Note:**  
Start logging by pushing in Searam switch plunger. Stop logging by pulling out Searam switch plunger.

**Notes:**

- The first cast is cast 0.
- Use Upload on the Toolbar or the Upload menu to upload data that will be processed by SBE Data Processing. Manually entering data upload commands does not produce data with the required header information for processing by our software.



FUNCTION	COMMAND	DESCRIPTION
<b>Commands not typically sent:</b> <i>Auto Fire General Setup</i>	<b>NB=x</b>	x= total number of bottles to be closed during deployment (maximum 24).
	<b>BC n,m</b>	Perform bottle closure <b>n</b> at pressure <b>m</b> (decibars). Repeat <b>NB</b> times, providing each closure pressure. Default 0 decibars for each bottle.
	<b>BS n,m</b>	Searam allows bottles to be fired out of numerical sequence. Bottle closure <b>n</b> closes bottle number <b>m</b> . Repeat <b>NB</b> times, providing closure sequence for each bottle. Default is <b>n</b> equals <b>m</b> (bottles close in order of bottle number).
<b>Commands not typically sent:</b> <i>Bottle Bottom Closure and Upcast Logic Setup</i>	<b>BBx</b>	<b>x=Y</b> : Enable bottom bottle closure – close a bottle when pressure remains within <b>BBP</b> decibars for <b>BBT</b> minutes. <b>x=N</b> : Disable bottom bottle closure.
	<b>BBP=x</b>	x= bottom bottle pressure window (decibars).
	<b>BBT=x</b>	x= bottom bottle time (minutes).
	<b>BUP=x</b>	x= pressure (decibars) to enable upcast.
	<b>BUD=x</b>	x= pressure decrease (decibars) from maximum to enable upcast.
<b>Commands not typically sent:</b> <i>Pressure Coefficients</i> Used to calculate pressure from pressure sensor frequency data, to determine when to close bottles. Should agree with Calibration Certificate shipped with Searam.	<b>PC1=x</b>	x=C1 coefficient
	<b>PC2=x</b>	x=C2 coefficient
	<b>PC3=x</b>	x=C3 coefficient
	<b>PD=x</b>	x=D coefficient
	<b>PT1=x</b>	x=T1 coefficient
	<b>PT2=x</b>	x=T2 coefficient
	<b>PT3=x</b>	x=T3 coefficient
	<b>PT4=x</b>	x=T4 coefficient
	<b>PADM=x</b>	x=Adm coefficient
<b>PADB=x</b>	x=Adb coefficient	

# Appendix IV: Replacement Parts

Part Number	Part	Application Description	Quantity in Searam
50092	SBE 16/19 Jackscrew Kit	For removing connector end cap	1
801512	NiMH battery pack (included with typical shipment)	12-cell rechargeable battery pack	1
90504	NiMH battery pack charger (included with typical shipment)	Includes NiMH charger, 17015 AC power cord, and 801509 charger cable	-
20165	Fuse, 5 x 20 mm, 3.0A, 250V, Fast Blow	For NiMH battery pack charger	
90488.2	Junction box	For external power to Searam for testing	-
41124B	Cover plate	For optional alkaline batteries	1
801380	4-pin RMG-4FS to DB-9S data I/O cable, 20 m (66 ft)	From Searam to computer	1
171888	25-pin DB-25S to 9-pin DB-9P cable adapter	For use with computer with DB-25 connector	-
17043	Locking sleeve	Locks I/O cable or dummy plug in place	1
17132	6-pin AG-206 to 6-pin AG-206 cable, 0.3 m (1.1 ft)	Searam to <i>9plus</i> interface cable	1
17198	6-pin AG-206 to 6-pin AG-206 cable, 2 m (6.6 ft)	Searam to Carousel interface cable	1
17046.1	4-pin RMG-4FS dummy plug with locking sleeve	For use when I/O cable not being used	1
17047.1	6-pin AG-206 dummy plug with locking sleeve	For use when <i>9plus</i> or Carousel cable not being used	2
801421	4-pin MCIL-4FS to DB-9S data I/O wet-pluggable cable, 20 m (66 ft)	From Searam to computer	1
171192	MCDLS-F wet-pluggable locking sleeve	Locks I/O cable or dummy plug in place	1
171796	6-pin MCIL-6FS to 6-pin MCIL-6FS wet-pluggable cable, 0.3 m (1.1 ft)	Searam to <i>9plus</i> interface cable	1
171741	6-pin MCIL-6FS to 6-pin MCIL-6FS wet-pluggable cable, 2 m (6.6 ft)	Searam to Carousel interface cable	1
171398.1	4-pin MCDL-4-F wet-pluggable dummy plug with locking sleeve	For use when I/O cable not being used	1
171498.1	6-pin MCDL-6-F wet-pluggable dummy plug with locking sleeve	For use when <i>9plus</i> or Carousel cable not being used	2

*Continued on next page*

Continued from previous page

Part Number	Part	Application Description	Quantity in Searam
50051	Small hardware and o-ring kit (aluminum housing)	Assorted hardware and o-rings, including: <ul style="list-style-type: none"> <li>• 30072 Parker 2-017N674-70 (for bulkhead connectors)</li> <li>• 30080 Parker 2-204N674-70 (for switch assembly)</li> <li>• 30090 Parker 2-153N674-70 (battery end cap face seal)</li> <li>• 30815 Parker 2-233E603-70 (for connector end cap)</li> <li>• 30816 Parker 2-234E603-70 (battery end cap radial seal)</li> <li>• 30145 Machine screw 6-32 x 1/2 PH SS (secure battery endplate)</li> <li>• 30154 Machine screw 8-32 x 3/8 PH SS (for groundstrap)</li> <li>• 30162 Machine screw 8-32 x 7/8 FH SS (secure Searam switch to housing)</li> <li>• 30164 Machine screw 8-32 x 1-1/8 PH SS (connector end cap hardware)</li> <li>• 30236 Washer, #8 nylon (for groundstrap)</li> <li>• 30242 Washer, #6 flat (secure battery endplate)</li> <li>• 30267 Screw insulator, #8 x 1/2 (for 30164)</li> <li>• 30362 Nut, 6-32 nylon stop (secure boardset to end cap through threaded rod)</li> </ul>	-
50140	Small hardware and o-ring kit (titanium housing)	Assorted hardware and o-rings, including: <ul style="list-style-type: none"> <li>• 30072 Parker 2-017N674-70 (for bulkhead connectors)</li> <li>• 30080 Parker 2-204N674-70 (for installing switch assembly)</li> <li>• 30090 Parker 2-153N674-70 (battery end cap face seal)</li> <li>• 30815 Parker 2-233E603-70 (for connector end cap)</li> <li>• 30816 Parker 2-234E603-70 (battery end cap radial seal)</li> <li>• 30145 Machine screw 6-32 x 1/2 PH SS (secure battery endplate)</li> <li>• 30654 Machine screw 8-32 x 3/4 FH TT (secure Searam switch to housing)</li> <li>• 30346 Bolt, 10-24 x 1" Hex TT (connector end cap hardware)</li> <li>• 30242 Washer, #6 flat (secure battery endplate)</li> <li>• 30362 Nut, 6-32 nylon stop (secure boardset to end cap through threaded rod)</li> <li>• 30447 Bolt, 1/4-20 x 1-1/4, Hex TT (secure battery end cap handle to end cap)</li> </ul>	-

Continued on next page

Continued from previous page

Part Number	Part	Application Description	Quantity in Searam
50105	Spares kit (aluminum housing, XSG / AG connectors)	Assorted cables, connectors, dummy plugs, and hardware, including: <ul style="list-style-type: none"> <li>• 50051 Small hardware &amp; o-ring Kit (see above)</li> <li>• 50092 Jackscrew kit (see above)</li> <li>• 17043 Plastic locking sleeve (for dummy plugs)</li> <li>• 17046 4-pin female dummy plug (for 4-pin bulkhead connector)</li> <li>• 17047 6-pin female dummy plug (for 6-pin bulkhead connector)</li> <li>• 17132 13" 6-pin to 6-pin cable (Searam to 9plus interface cable)</li> <li>• 17628 6-pin bulkhead connector (Carousel or 9plus connector)</li> <li>• 17654 4-pin bulkhead connector (I/O connector)</li> <li>• 23155.1 Switch (magnetic switch assembly)</li> <li>• 30044 Anode, 1" (for corrosion prevention)</li> <li>• 41124B Battery cover PCB (battery compartment cover plate for alkaline batteries)</li> </ul>	-
50141	Spares kit (titanium housing, XSG / AG connectors)	Assorted cables, connectors, dummy plugs, and hardware, including: <ul style="list-style-type: none"> <li>• 50092 Jackscrew kit (see above)</li> <li>• 50140 Small hardware &amp; o-ring kit (see above)</li> <li>• 17043 Plastic locking sleeve (for dummy plugs)</li> <li>• 17046 4-pin female dummy plug (for 4-pin bulkhead connector)</li> <li>• 17047 6-pin female dummy plug (for 6-pin bulkhead connector)</li> <li>• 17132 13" 6-pin to 6-pin cable (Searam to 9plus interface cable)</li> <li>• 17628 6-pin bulkhead connector (Carousel or 9plus connector)</li> <li>• 17654 4-pin bulkhead connector (I/O connector)</li> <li>• 23155.1 Switch (magnetic switch assembly)</li> <li>• 41124B Battery cover PCB (battery compartment cover plate for alkaline batteries)</li> </ul>	-

Continued on next page

Continued from previous page

Part Number	Part	Application Description	Quantity in Searam
50328	Spares kit (aluminum housing, wet-pluggable connectors)	Assorted cables, connectors, dummy plugs, and hardware, including: <ul style="list-style-type: none"> <li>• 50051 Small hardware &amp; o-ring Kit (see above)</li> <li>• 50092 Jackscrew kit (see above)</li> <li>• 171192 Plastic locking sleeve, (for dummy plugs)</li> <li>• 171398 4-pin female dummy plug (for 4-pin bulkhead connector)</li> <li>• 171498 6-pin female dummy plug (for 6-pin bulkhead connector)</li> <li>• 171796 13" 6-pin to 6-pin cable (Searam to 9plus)</li> <li>• 172025 4-pin bulkhead connector (I/O connector)</li> <li>• 172026 6-pin bulkhead connector (Carousel or 9plus connector)</li> <li>• 23155.1 Switch (magnetic switch assembly)</li> <li>• 30044 Anode, 1" (for corrosion prevention)</li> <li>• 41124B Battery cover PCB (battery compartment cover plate for alkaline batteries)</li> </ul>	-
50329	Spares kit (titanium housing, wet-pluggable connectors)	Assorted cables, connectors, dummy plugs, and hardware, including: <ul style="list-style-type: none"> <li>• 50092 Jackscrew kit (see above)</li> <li>• 50140 Small hardware &amp; o-ring kit (see above)</li> <li>• 171192 Plastic locking sleeve (for dummy plugs)</li> <li>• 171398 4-pin female dummy plug (for 4-pin bulkhead connector)</li> <li>• 171498 6-pin female dummy plug (for 6-pin bulkhead connector)</li> <li>• 171796 13" 6-pin to 6-pin cable (Searam to 9plus cable)</li> <li>• 172021 4-pin bulkhead connector (I/O connector)</li> <li>• 172022 6-pin bulkhead connector (Carousel or 9plus connector)</li> <li>• 23155.1 Switch (magnetic switch assembly)</li> <li>• 41124B Battery cover PCB (battery compartment cover plate for alkaline batteries)</li> </ul>	-

# Appendix V: Manual Revision History

Manual Version	Date	Description
001		<ul style="list-style-type: none"> <li>Initial release.</li> </ul>
002		<ul style="list-style-type: none"> <li>Remove 3400 meter option.</li> <li>Add high resolution Quartz pressure sensor upper frequency limit.</li> </ul>
003	03/00	<ul style="list-style-type: none"> <li>Add auto fire capability.</li> <li>Incorporate use of SeatermAF.</li> <li>Rewrite.</li> </ul>
004	06/03	<ul style="list-style-type: none"> <li>Add information on manually checking functioning of Carousel in lab by communicating with Carousel through 17plus using SeatermAF.</li> <li>Add information that setting time without date resets date to last date set with <b>ddmmyy=</b> or <b>mmddy=</b>.</li> <li>Add information that 9plus with serial data uplink option can not work with 17plus.</li> <li>Add wet-pluggable connectors.</li> <li>Update information on data format – descriptions of format from 9 were not current.</li> <li>Update firmware version – was 5.1, then renumbered and it is now 1.4 (started back to 1.0 for V2 of 17plus).</li> <li>Add information about using jackscrews to remove end cap for Electronics disassembly/reassembly</li> </ul>
005	09/04	<ul style="list-style-type: none"> <li>Update for new firmware (1.6) that is compatible with NiMH batteries. Change battery command from <b>BX</b> to <b>BatteryType=</b>.</li> <li>NiMH batteries/charger now shipping standard with 17plus, instead of Ni-Cads.</li> <li>Remove “would you like to program the auto fire” question that SeatermAF asked when you exited configure dialog box.</li> <li>Add information on processing uploaded data into bottle file and CTD data file.</li> </ul>
006	03/05	<ul style="list-style-type: none"> <li>Note tight fit of NiMH battery pack in housings, avoid dinging side, align carefully and put it straight in housing, could rip shrink wrap if not careful.</li> <li>Can use 17plus to provide data backup while using 9plus with 11plus.</li> <li>Remove incorrect MAL designation for wet-pluggable connector callouts.</li> </ul>
007	03/07	<ul style="list-style-type: none"> <li>Correct <b>FlashInitialize</b> to <b>Flash Initialize</b>, <b>FlashMap</b> to <b>Flash Map</b>, and <b>EraseMemory</b> to <b>Erase Memory</b> – space in middle, no underscore.</li> <li>Add more detailed information about byte 29 4LSB (9plus status).</li> <li>Add note that 17plus overwrites bottle confirm bit from 9plus, because 9plus only sets it for a GO 1015 Rosette, not for a 1016 Rosette or Carousel.</li> <li>Add more detailed information for Testing Carousel operation section.</li> <li>Update information on .dat file for 911plus data from Seasave: no more .dat file when using Seasave V7.</li> <li>Update .con file screen capture.</li> <li>Update Data Conversion screen captures to show Miscellaneous tab.</li> <li>Update callout for wet-pluggables – switched to WB type.</li> <li>Update Recovery Warning.</li> <li>Update SeatermAF 17plus Communication Settings screen.</li> </ul>
008	05/08	<ul style="list-style-type: none"> <li>Correct JT assignments to Auxiliary channels in Command Summary Appendix.</li> <li>Correct Format Type 1 in Data Formats.</li> <li>Define <i>stop=bfrate</i> message in DH response.</li> <li>Add information to replace alkaline batteries yearly to prevent leakage.</li> <li>Update connector maintenance to be consistent with application note 57.</li> </ul>
009	12/09	<ul style="list-style-type: none"> <li>SBE Data Processing 7.20a: Add information about .xmlcon file, but continue to use .con file because SeatermAF not yet compatible with .xmlcon file.</li> <li>Update .con file screen capture to current version.</li> <li>Update photos of NiMH charger.</li> <li>Add CE mark.</li> <li>Update SBE address.</li> </ul>

Continued on next page

*Continued from previous page*

010	05/11	<ul style="list-style-type: none"> <li>• Add cautions about use with alkaline batteries and limiting voltage to 15 VDC if integrating 9plus with voltage-sensitive sensors.</li> <li>• Change external power input specification to 12 – 15 VDC.</li> <li>• SBE Data Processing 7.20c: Update Bottle Summary Data Setup dialog box to reflect ability to enable/disable oxygen Tau correction.</li> <li>• SBE Data Processing version 7.21a: Update configuration dialog box to reflect changes. Update Data Conversion Data Setup dialog box to reflect changes.</li> <li>• Add information about Windows Vista and Windows 7 compatibility.</li> <li>• Note that optional Ni-Cad batteries and charger are no longer available.</li> </ul>
011	05/12	<ul style="list-style-type: none"> <li>• Update SeatermAF software description and use with SeatermAF V2.</li> </ul>
012	04/13	<ul style="list-style-type: none"> <li>• Add Declaration of Conformity.</li> <li>• Add cable and wiring diagrams.</li> <li>• SeatermAF updates: Update SeatermAF main screen, and add Configure Header Form button on Upload &amp; Header Options dialog.</li> <li>• Update software compatibility information.</li> <li>• Fix typos.</li> </ul>
013	02/15	<ul style="list-style-type: none"> <li>• Update Declaration of Conformity.</li> <li>• Add O-ring maintenance section.</li> <li>• Add caution regarding using spray silicone lubricants on MCBH connectors.</li> <li>• Add caution regarding using Parker Super O-lube, not Parker O-lube (which is petroleum based).</li> <li>• Remove <i>standard</i> and <i>optional</i> language related to 17plus features.</li> <li>• Update SBE Data Processing configuration dialog box.</li> <li>• Update language on where to find updated software on website.</li> <li>• Change 17plus 'bottom end cap' terminology to 'battery end cap' for clarity.</li> <li>• Fix typos.</li> <li>• Switch to new Sea-Bird Scientific manual cover.</li> </ul>
014	05/16	<ul style="list-style-type: none"> <li>• Add information that cannot close more than 24 bottles.</li> <li>• Correct NiMH battery pack part number in replacement parts list.</li> <li>• Remove 90059 and 90046 junction boxes for external power for testing from replacement parts list (no longer manufacture those); replace with 90488.2.</li> <li>• Update Declaration of Conformity.</li> </ul>

# Index

---

.con file · 33, 47  
 .ini file · 16  
 .psa file · 16  
 .xmlcon file · 33, 47

## A

Alkaline batteries · 14, 27, 57  
 Averaging · 38

## B

Batteries · 9, 14, 27  
   recharging Ni-Cad · 56  
   recharging NiMH · 54  
   replacing alkaline · 57  
 Battery type · 20  
 Baud rate · 19  
 Bottle closure logic · 21, 32  
 Bottle closure pressures · 22  
 Bottom bottle · 21, 32

## C

Cables · 11  
 Carousel  
   testing · 39  
 CE certification · 3  
 Clock · 9, 13  
 Command summary · 63  
 Commands · 25  
   auto fire · 32  
   auto fire arm/disarm · 30  
   bottle closure logic · 32  
   data upload · 30  
   diagnostic · 31  
   general setup · 27  
   SBE 32 Carousel setup · 29  
   SBE 9plus pressure coefficients · 33  
   SBE 9plus setup · 28  
   status · 26  
 Communication defaults · 19  
 Configuration file · 33, 47  
 Connectors · 10, 53  
 Corrosion precautions · 53

## D

Data bits · 19  
 Data I/O · 9, 14  
 Data output formats · 34  
 Data processing · 46  
 Declaration of Conformity · 3  
 Deployment · 41  
   preparing for · 15  
   setup · 40  
 Dimensions · 10

## E

Editing raw data · 52  
 Electrical connections · 10  
 Electronics  
   description · 60  
   disassembly/reassembly · 61  
 End cap · 10, 53

## F

Firmware version · 20  
 Frequency limitations · 38  
 Functional description · 60

## G

Glossary · 59

## H

Header options · 23

## L

Logging on/off · 13

## M

Maintenance · 53  
 Manual revision history · 70  
 Memory · 9, 13

## N

Ni-Cad batteries · 14, 27, 56  
 NiMH batteries · 14, 27, 54

## O

O-ring  
   maintenance · 58

## P

Parity · 19  
 Parker Super O-Lube · 59  
 Parts  
   replacement · 66  
 Power · 9, 14, 54  
 Power and communications test · 15  
 Preparing for deployment · 15  
 Processing data · 46

## Q

Quick start · 6

## R

Raw data  
   editing · 52  
 Real-time clock · 9, 13  
 Recovery  
   physical handling · 42  
   uploading data · 43  
 Replacement parts · 66  
 Revision history · 70  
 RS-232 interface · 9, 14



---

**S**

SBE 32  
  testing · 39  
SBE Data Processing · 9, 15, 45, 46  
Seasoft · 9, 15, 16, 45  
SeatermAF  
  main screen · 16  
  toolbar buttons · 17  
SeatermAF V2 · 9, 15, 16, 39, 40, 43  
  communication defaults · 19  
Serial port · 19  
Software · 9  
Software installation · 15  
Specifications · 9  
Super O-Lube · 59  
Switch plunger · 13  
System description · 8

---

**T**

Testing · 15

---

**U**

Unpacking Searam · 7  
Upload options · 23  
Uploading data · 43

---

**V**

Versions · 70

---

**W**

Wiring · 11