

SBE 37-SMP MicroCAT

*Conductivity, Temperature, and (optional) Pressure Recorder
with RS-232 Interface and Integral Pump*



For most applications, deploy in orientation shown (connector end down) for proper operation

Shown with ShallowCAT plastic housing; titanium housing available

User's Manual

Sea-Bird Electronics, Inc.
13431 NE 20th Street
Bellevue, Washington 98005 USA
Telephone: +1 425-643-9866
Fax: +1 425-643-9954
E-mail: seabird@seabird.com
Website: www.seabird.com

Manual version #020, 03/11/14
Firmware version 4.1 and later
SeatermV2 version 2.3.0 and later
SBE Data Processing version 7.23.1 and later



Limited Liability Statement

Extreme care should be exercised when using or servicing this equipment. It should be used or serviced only by personnel with knowledge of and training in the use and maintenance of oceanographic electronic equipment.

SEA-BIRD ELECTRONICS, INC. disclaims all product liability risks arising from the use or servicing of this system. SEA-BIRD ELECTRONICS, INC. has no way of controlling the use of this equipment or of choosing the personnel to operate it, and therefore cannot take steps to comply with laws pertaining to product liability, including laws which impose a duty to warn the user of any dangers involved in operating this equipment. Therefore, acceptance of this system by the customer shall be conclusively deemed to include a covenant by the customer to defend, indemnify, and hold SEA-BIRD ELECTRONICS, INC. harmless from all product liability claims arising from the use or servicing of this system.

Declaration of Conformity

Sea-Bird Electronics, Inc.
13431 NE 20th Street, Bellevue, WA 98005 USA

DECLARATION OF CONFORMITY

Manufacturer's Name: Sea-Bird Electronics
Manufacturer's Address: 13431 NE 20th Street
Bellevue, WA 98005, USA

The Authorized Representative located within the Community is:
OTT MESSTECHNIK GmbH & Co.KG
P.O.Box: 2140 / 87411 Kempten / Germany
Ludwigstrasse 16 / 87437 Kempten
Internet: <http://www.ott.com>
Phone: +49 831 5617 – 100
Fax: +49 831 5617 - 209

Device Description: Various Data Acquisition Devices and Sensors

Model Numbers:

3S	3F	3plus	4C	4M	5T	5P	5M	7
8	9plus	11plus	14	16plus V2	16plus-IM V2		17plus V2	18
19plus V2	21	25plus	26plus	27	29	32	32C	32SC
33	35	35RT	36	37-IMP	37-IM	37-SMP	37-SM	37-SIP
37-SI	38	39	39-IM	39plus	41	41CP	43	43F
44	45	49	50	52-MP	53BPR	54	55	56
63	SIM	ICC	IMM	PDIM	AFM	90488	90204	90402
90504	Glider Payload CTD		NiMH Battery Charger and Battery Pack					

Applicable EU Directives: Machinery Directive 98 / 37 /EC
EMC Directive 2004 / 108 /EC
Low Voltage Directive (73 / 23 /EEC) as amended by (93 / 68 /EEC)

Applicable Harmonized Standards:
EN 61326-1:2006 Class A Electrical Equipment for Measurement, Control, and Laboratory Use, EMC Requirement – Part 1: General Requirements
(EN 55011:2007 Group 1, Class A)

EN 61010-1:2001, Safety Requirements for Electrical Equipments for Measurement, Control, and Laboratory Use – Part 1: General Requirements

Declaration based upon compliance to the Essential Requirements and Letter of Opinion from KKC Certification Services, LLC., Notified Body 0976

I, the undersigned, hereby declare that the equipment specified above conforms to the above European Union Directives and Standards.

Authorized Signature: 
Name: Nordeen Larson
Title of Signatory: President
Date: 3 September 2013
Place: Bellevue, WA

Table of Contents

Limited Liability Statement	2
Declaration of Conformity	3
Table of Contents	4
Section 1: Introduction	6
About this Manual	6
Quick Start	6
Unpacking MicroCAT	7
Shipping Precautions	8
Section 2: Description of MicroCAT	9
System Description	9
Specifications.....	11
Dimensions and End Cap Connector	12
Cables and Wiring	13
Sample Timing.....	14
Battery Pack Endurance.....	14
External Power.....	15
Cable Length and External Power	15
Section 3: Preparing MicroCAT for Deployment	17
Battery Pack Installation	17
Software Installation	19
Power and Communications Test	19
Test Setup	19
Test	20
Section 4: Deploying and Operating MicroCAT	25
Sampling Modes	25
Polled Sampling.....	26
Autonomous Sampling (Logging commands).....	27
Serial Line Synchronization (Serial Line Sync)	28
Real-Time Data Acquisition	29
Timeout Description	29
Command Descriptions.....	30
Data Formats.....	45
Optimizing Data Quality / Deployment Orientation	47
Setup for Deployment.....	48
Deployment.....	49
Recovery	50
Uploading and Processing Data	51
Editing Raw Data File.....	58
Section 5: Routine Maintenance and Calibration	59
Corrosion Precautions.....	59
Connector Mating and Maintenance	59
Conductivity Cell Maintenance	60
Plumbing Maintenance	60
Handling Instructions for Plastic <i>ShallowCAT</i>	61
Replacing Cells	62
Pressure Sensor (optional) Maintenance	62
O-Ring Maintenance.....	62
Replacing Anti-Foulant Devices – Mechanical Design Change	63
Replacing Anti-Foulant Devices (SBE 37-SI, SM, IM).....	64
Sensor Calibration.....	65

Section 6: Troubleshooting	67
Problem 1: Unable to Communicate with MicroCAT	67
Problem 2: No Data Recorded	67
Problem 3: Unreasonable T, C, or P Data.....	67
Problem 4: Salinity Spikes.....	68
Glossary	69
Appendix I: Functional Description	71
Sensors	71
Sensor Interface	71
Real-Time Clock.....	71
Appendix II: Electronics Disassembly/Reassembly	72
Appendix III: Command Summary	74
Appendix IV: AF24173 Anti-Foulant Device	76
Appendix V: Replacement Parts	80
Appendix VI: Manual Revision History	82
Index	85

Section 1: Introduction

This section includes a Quick Start procedure, photos of a typical MicroCAT shipment, and battery shipping precautions.

About this Manual

This manual is to be used with the SBE 37-SMP MicroCAT Conductivity and Temperature Recorder (pressure optional) with RS-232 Serial interface, internal Memory, and integral Pump. It is organized to guide the user from installation through operation and data collection. We've included detailed specifications, command descriptions, maintenance and calibration information, and helpful notes throughout the manual.

Sea-Bird welcomes suggestions for new features and enhancements of our products and/or documentation. Please contact us with any comments or suggestions (seabird@seabird.com or 425-643-9866). Our business hours are Monday through Friday, 0800 to 1700 Pacific Standard Time (1600 to 0100 Universal Time) in winter and 0800 to 1700 Pacific Daylight Time (1500 to 0000 Universal Time) the rest of the year.

Quick Start

Follow these steps to get a Quick Start using the MicroCAT. The manual provides step-by-step details for performing each task:

1. Install AA lithium cells and test power and communications (*Section 3: Preparing MicroCAT for Deployment*).
2. Deploy the MicroCAT (*Section 4: Deploying and Operating MicroCAT*):
 - A. Install new AA lithium cells if necessary.
 - B. Ensure all data has been uploaded, and then send **InitLogging** to make entire memory available for recording if desired.
 - C. Set date and time, and establish setup and logging parameters.
 - D. Check status (**DS**) and calibration coefficients (**DC**) to verify setup.
 - E. Set MicroCAT to start logging now or in the future.
 - F. Remove yellow protective label from plumbing intake and exhaust. Remove conductivity cell guard, and verify AF24173 Anti-Foulant Devices are installed. Replace conductivity cell guard. Leave label off for deployment.
 - G. Install dummy plug or cable connector, and locking sleeve.
 - H. Deploy MicroCAT, using Sea-Bird or customer-supplied hardware. For **most** applications, mount the MicroCAT with the connector at the bottom for proper operation.
 - I. Upload data from memory.

Unpacking MicroCAT

Shown below is a typical MicroCAT shipment.



SBE 37-SMP MicroCAT



12 AA lithium cells



I/O cable



Spare hardware and o-ring kit



Conductivity cell cleaning solution (Triton-X)



Software, and Electronic Copies of Software Manuals and User Manual

Shipping Precautions

DISCLAIMER / WARNING:

The shipping information provided in is a general overview of lithium battery shipping requirements; it does not provide complete shipping information. The information is provided as a courtesy, to be used as a guideline to assist properly trained shippers. These materials do not alter, satisfy, or influence any federal or state requirements. These materials are subject to change due to changes in government regulations. Sea-Bird accepts no liability for loss or damage resulting from changes, errors, omissions, or misinterpretations of these materials. **See the current edition of the IATA Dangerous Good Regulations for complete information on packaging, labeling, and shipping document requirements.**



WARNING!
Do not ship assembled battery pack.

Assembled battery pack

For its main power supply, the MicroCAT uses twelve 3.6-volt AA lithium cells (Saft LS14500). The MicroCAT was shipped from the factory with the batteries packaged separately within the shipping box (not inside MicroCAT).

BATTERY PACKAGING

Cells are packed in heat-sealed plastic, and then placed in bubble-wrap outer sleeve and strong packaging for shipment.



If the shipment is not packaged as described above, or does not meet the requirements below, the shipment is considered Dangerous/Hazardous Goods, and must be shipped according to those rules.

	1-5 MicroCATs and associated cells, but no spares	1-5 MicroCATs and associated cells, plus up to 2 spare cell sets/MicroCAT	Spares (without MicroCATs) – Note new rules as of January 1, 2013
UN #	UN3091	UN3091	Must be shipped as Class 9 Dangerous Goods. If re-shipping spares, you must have your own Dangerous Goods program.
Packing Instruction (PI) #	969	969	
Passenger Aircraft	Yes	No	
Cargo Aircraft	Yes	Yes	
Labeling Requirement	1 **	1, 2 **	
Airway Bill (AWB) Requirement	Yes *	Yes *	

* AWB must contain following information in Nature and Quantity of Goods Box: "Lithium Metal Batteries", "Not Restricted", "PI #"

** Labels are defined below:



2

1 – Shipper must provide an emergency phone number

Note:

Remove the cells before returning the MicroCAT to Sea-Bird. Do not return used cells when shipping the MicroCAT for calibration or repair. All setup information is preserved when the cells are removed.

Install the battery pack assembly in the MicroCAT for testing (see *Battery Pack Installation* in Section 3). **If you will re-ship the MicroCAT after testing:**

1. Remove the battery pack assembly from the MicroCAT.
2. Remove the cells from the battery pack assembly.
3. Pack the cells properly for shipment, apply appropriate labels, and prepare appropriate shipping documentation.

Section 2: Description of MicroCAT

This section describes the functions and features of the SBE 37-SMP MicroCAT, including specifications, dimensions, end cap connectors, sample timing, battery pack endurance, and external power.

System Description

Plastic *ShallowCAT*
housing



For most applications, deploy in orientation shown (connector end down) for proper operation – see *Optimizing Data Quality / Deployment Orientation* in Section 4: *Deploying and Operating MicroCAT*

The SBE 37-SMP MicroCAT is a high-accuracy conductivity and temperature recorder (pressure optional) with internal battery pack and non-volatile memory, an integral pump, and an **RS-232** serial interface. Designed for moorings and other long-duration, fixed-site deployments, MicroCATs have non-corroding housings. The MicroCAT is rated for operation to 350 meters (plastic *ShallowCAT* housing) or 7000 meters (titanium housing), or pressure sensor full-scale range.

Communication with the MicroCAT is over an internal, 3-wire, RS-232C link. Over 50 different commands can be sent to the MicroCAT to provide status display, data acquisition setup, data retrieval, and diagnostic tests.

User-selectable operating modes include:

- **Autonomous sampling** – At pre-programmed intervals, the MicroCAT wakes up, runs the pump, samples, stores the data in its FLASH memory, and goes to sleep. If desired, real-time data can also be transmitted.
- **Polled sampling** – On command, the MicroCAT runs the pump, takes one sample, and transmits the data. Polled sampling is useful for integrating the MicroCAT with satellite, radio, or wire telemetry equipment.
- **Serial line sync** – In response to a pulse on the serial line, the MicroCAT wakes up, runs the pump, samples, stores the data in its FLASH memory, and goes to sleep. If desired, real-time data can also be transmitted. Serial line sync provides an easy method for synchronizing MicroCAT sampling with other instruments such as Acoustic Doppler Current Profilers (ADCPs) or current meters, without drawing on their battery or memory resources.

The MicroCAT can be deployed in two ways:

- **Cable installed** – The MicroCAT can be remotely controlled, allowing for polled sampling or serial line sync, or for periodic requests of data from the MicroCAT memory. If desired, data can be periodically uploaded while the MicroCAT remains deployed. Additionally, the MicroCAT can be externally powered.
- **Dummy plug installed** – The MicroCAT cannot be remotely controlled. Autonomous sampling is programmed before deployment, and data is uploaded after recovery.

Calibration coefficients stored in EEPROM allow the MicroCAT to transmit data in engineering units. The MicroCAT retains the temperature and conductivity sensors used in the Seacat and Seacat *plus* family. The MicroCAT's aged and pressure-protected thermistor has a long history of exceptional accuracy and stability (typical drift is less than 0.002 °C per year). Electrical isolation of the conductivity electronics eliminates any possibility of ground-loop noise.

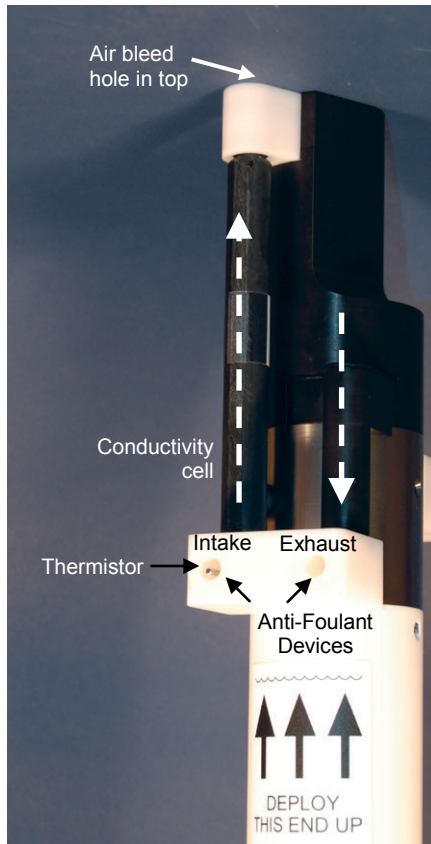

Shown with conductivity cell guard removed

The MicroCAT's internal-field conductivity cell is immune to proximity errors and unaffected by external fouling. The conductivity cell guard retains the expendable AF24173 Anti-Foulant Devices at the conductivity cell intake and pump exhaust.

The MicroCAT's integral pump runs for 1.0 second each time the MicroCAT takes a sample, providing the following advantages over a non-pumped system:

- Improved conductivity response – The pump flushes the previously sampled water from the conductivity cell and brings a new water sample quickly into the cell.
- Reduced fouling – Water does not freely flow through the conductivity cell between samples, minimizing fouling.

Note that the MicroCAT was designed to be deployed as shown, with the sensor end up, providing an inverted U-shape for the flow. This orientation prevents sediment from being trapped in the pump impeller housing. An air bleed hole in the top of the duct allows air to escape from the plumbing, so the pump will prime. See *Optimizing Data Quality / Deployment Orientation* in *Section 4: Deploying and Operating MicroCAT*.

The MicroCAT's optional strain-gauge pressure sensor is available in the following pressure ranges: 20, 100, 350, 600, 1000, 2000, 3500, and 7000 meters. Compensation of the temperature influence on pressure offset and scale is performed by the MicroCAT's CPU.

Future upgrades and enhancements to the MicroCAT firmware can be easily installed in the field through a computer serial port and the bulkhead connector on the MicroCAT, without the need to return the MicroCAT to Sea-Bird.

Notes:

- Help files provide detailed information on the software.
- A separate software manual on CD-ROM contains detailed information on the setup and use of SBE Data Processing.
- Sea-Bird supplies the current version of our software when you purchase an instrument. As software revisions occur, we post the revised software on our FTP site. See our website (www.seabird.com) for the latest software version number, a description of the software changes, and instructions for downloading the software from the FTP site.

The MicroCAT is supplied with a powerful software package, Seasoft[®] V2, which includes:

- **Deployment Endurance Calculator**– program for determining deployment length based on user-input deployment scheme, instrument power requirements, and battery capacity.
- **SeatermV2** – terminal program for easy communication and data retrieval. SeatermV2 is a *launcher*, and launches the appropriate terminal program for the selected instrument (**Seaterm232** for RS-232 instruments such as this MicroCAT).
- **SBE Data Processing** - program for calculation and plotting of conductivity, temperature, pressure (optional), and derived variables such as salinity and sound velocity.

Specifications

Note:
Pressure ranges are expressed in meters of deployment depth capability.

	Temperature (°C)	Conductivity (S/m)	Optional Pressure
Measurement Range	-5 to +45	0 to 7 (0 to 70 mS/cm)	0 to full scale range: 20 / 100 / 350 / 600 / 1000 / 2000 / 3500 / 7000 meters
Initial Accuracy	± 0.002 (-5 to 35 °C); ± 0.01 (35 to 45 °C)	± 0.0003 (0.003 mS/cm)	± 0.1% of full scale range
Typical Stability	0.0002 per month	0.0003 (0.003 mS/cm) per month	0.05% of full scale range per year
Resolution	0.0001	0.00001 (0.0001 mS/cm)	0.002% of full scale range
Sensor Calibration	+1 to +32	0 to 6; physical calibration over range 2.6 to 6 S/m, plus zero conductivity (air)	Ambient pressure to full scale range in 5 steps
Memory	8 Mbyte non-volatile FLASH memory		
Data Storage	Conductivity & temperature: 6 bytes per sample (3 bytes each) Time: 4 bytes per sample. Pressure (optional): 5 bytes per sample.		
	Recorded Parameters	Memory Space (number of samples)	
	C, T, and time	800,000	
	C, T, P, and time	533,000	
Real-Time Clock	32,768 Hz TCXO accurate to ±1 minute/year.		
Battery Pack	Nominal 7.8 Amp-hour pack consisting of 12 AA Saft LS 14500 lithium cells (3.6 V and 2.6 Amp-hours each), with 3 strings of 4 cells. Capacity for more than 380,000 samples for a typical sampling scheme (see <i>Battery Pack Endurance</i> for example calculation). See <i>Shipping Precautions</i> in <i>Section 1: Introduction</i> . Note: Saft cells can be purchased from Sea-Bird or other sources. See Saft's website for suppliers (www.saftbatteries.com). Alternatively, substitute either of the following: - Tadiran TL-4903, AA (3.6 V and 2.4 Amp-hours each) (www.tadiran.com) - Electrochem 3B0064/BCX85, AA (3.9 V and 2.0 Amp-hours each) (www.electrochemsolutions.com)		
External Power	0.25 Amps at 9 - 24 VDC. To avoid draining internal battery pack, use an external voltage greater than 10 VDC. See <i>External Power</i> .		
Power Requirements	<ul style="list-style-type: none"> • Quiescent current: 30 microAmps. • Communication current: 4.3 milliAmps. • Acquisition current (excluding pump): <ul style="list-style-type: none"> - 9.1 milliAmps if transmitting real-time data. - 7.9 milliAmps if not transmitting real-time data. • Pump current: 25.3 milliAmps (0.025 Amp-second per 1.0 second pulse) Acquisition time: 1.9 – 2.9 seconds per sample (depending on sampling mode and inclusion of pressure sensor, see <i>Sample Timing</i>).		
Housing and Depth Rating	Titanium housing rated at 7000 m (23,000 ft) Plastic housing rated at 350 m (1150 ft)		
Weight (with clamps)	Titanium housing: 3.7 kg (8.3 lbs) in air, 2.2 kg (4.8 lbs) in water Plastic housing: 3.4 kg (7.5 lbs) in air, 1.6 kg (3.5 lbs) in water		

CAUTION:
See *Section 5: Routine Maintenance and Calibration* for handling instructions for the plastic *ShallowCAT* housing.

Dimensions and End Cap Connector

Note:
For most applications, deploy in the orientation shown (connector end down) for proper operation.

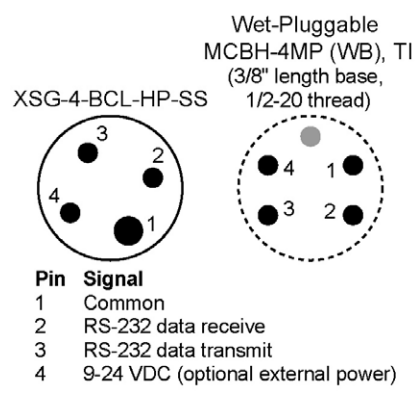
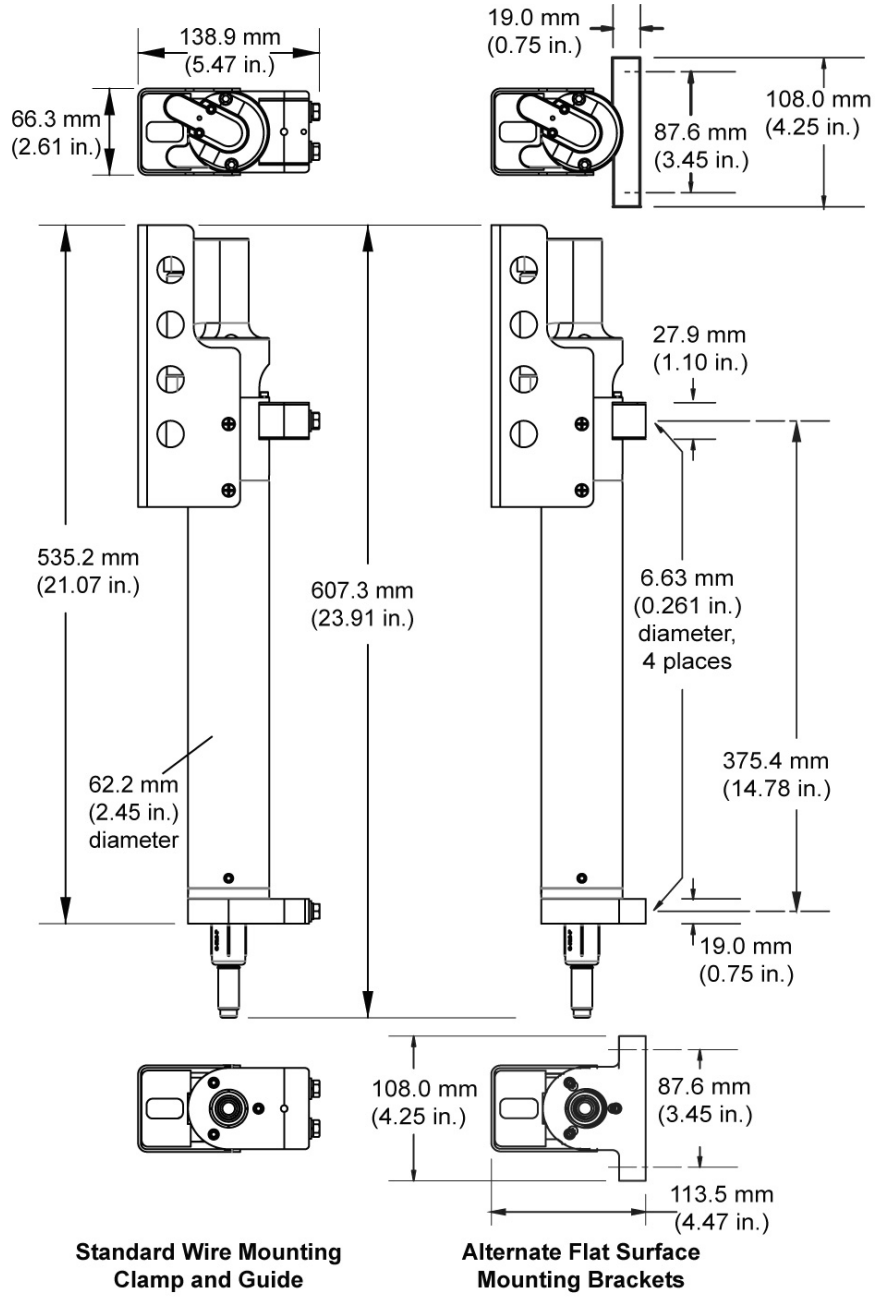

Cables and Wiring

RMG Connector Cable Wiring -- DN 32277

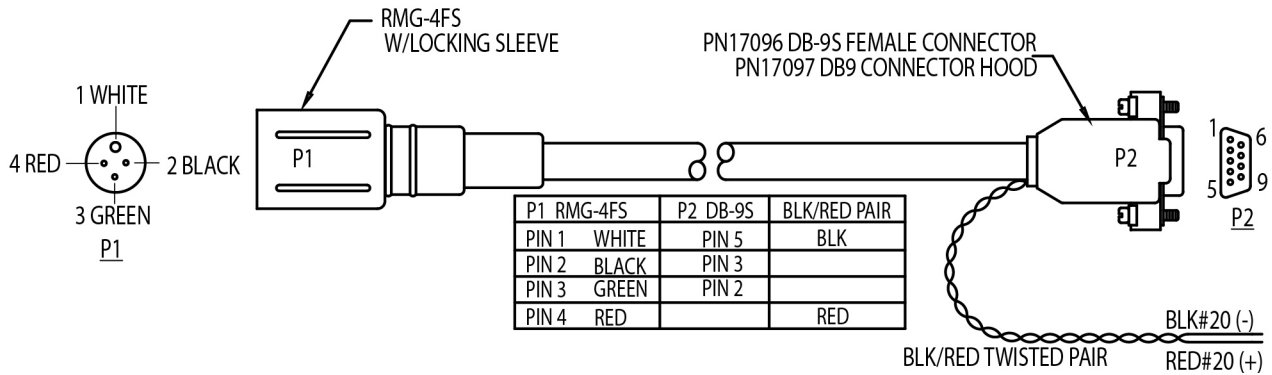

MCIL Wet-Pluggable Connector Cable Wiring -- DN 32366

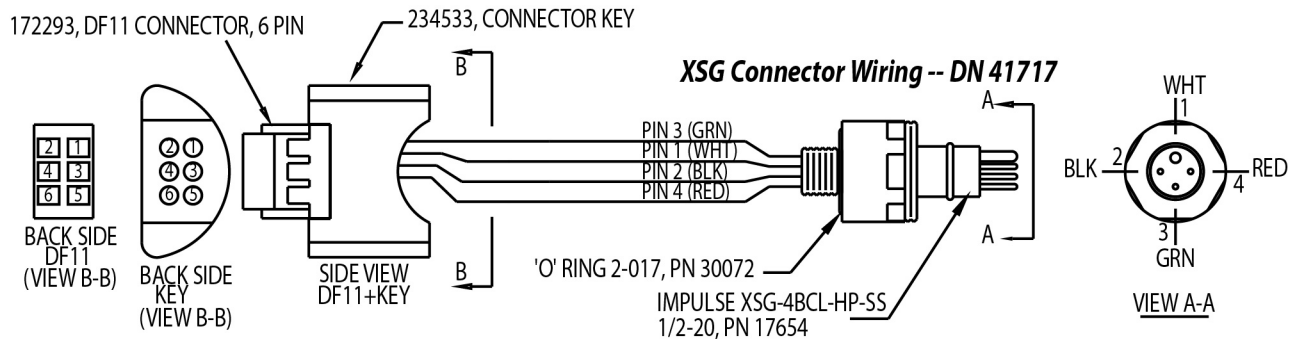
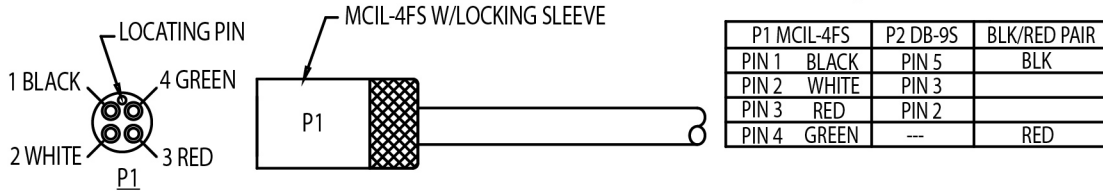

DF11 CONNECTOR	BULKHEAD CONNECTOR	FUNCTION
PIN 1	PIN 3 (GRN)	TX TO PC
PIN 2	PIN 1 (WHT)	COMMON
PIN 3	PIN 2 (BLK)	RX FROM PC
PIN 4	PIN 4 (RED)	EXTERNAL PWR
PIN 5		
PIN 6		

MCBH Wet-Pluggable Connector Wiring -- DN 41718

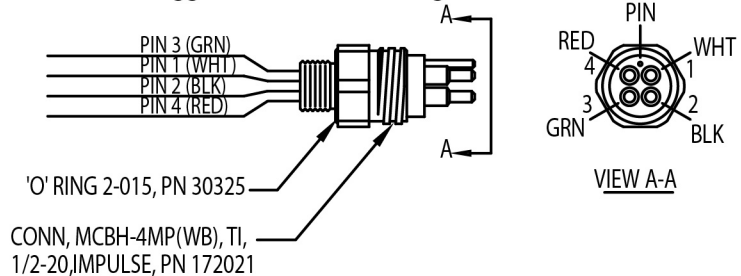

Sample Timing

Notes:

- Acquisition time shown does not include time to transmit real-time data, which is dependent on baud rate (**BaudRate=**) and number of characters being transmitted (defined by **OutputFormat=**, **OutputSal=**, and **OutputSV=**).
- Time stored and output with the data is the time at the **start** of the sample, after a small amount of time for the MicroCAT to wake up, run the pump, and prepare to sample. For example, if the MicroCAT is programmed to wake up and sample at 12:00:00, the stored time will indicate 12:00:01 or 12:00:02.

Sample timing is dependent on several factors, including sampling mode and whether the MicroCAT has an optional pressure sensor. The pump runs for 1.0 second while the Wein bridge is stabilizing before each measurement.

Autonomous Sampling (time between samples = **SampleInterval**) or Serial Line Sync Sampling

Power on time for each sample while logging, if not transmitting real-time data:

- Without pressure:** power-on time = 1.9 seconds to run pump and sample
- With pressure:** power-on time = 2.6 seconds to run pump and sample

Power on time for each sample while logging, if transmitting real-time data:

- Without pressure:** power-on time = 2.2 seconds to run pump and sample
- With pressure:** power-on time = 2.9 seconds to run pump and sample

Polled Sampling

Time from receipt of take sample command to beginning of reply:

- Without pressure:** power-on time = 1.9 seconds to run pump and sample
- With pressure:** power-on time = 2.6 seconds to run pump and sample

Battery Pack Endurance

Notes:

- If the MicroCAT is logging data and the battery voltage is less than 7.1 volts for five consecutive scans, the MicroCAT halts logging.
- Sea-Bird recommends using the capacity value of 6.0 Amp-hours for the Saft cells as well as the alternate cell types (Tadiran TL-4903 and Electrochem 3B0064/BCX85 AA).
- This MicroCAT uses a battery pack with a **yellow** cover plate. Older MicroCATs used a battery pack with a red cover plate; the wiring of the red battery pack is different from this one, and cannot be used with this MicroCAT.
- See **Specifications** above for data storage limitations.

The battery pack (4 cells in series, 3 parallel strings) has a nominal capacity of 7.8 Amp-hours (2.6 Amp-hours * 3). For planning purposes, to account for the MicroCAT's current consumption patterns and for environmental conditions affecting cell performance, **Sea-Bird recommends using a conservative value of 6.0 Amp-hours.**

Acquisition current varies, depending on whether the MicroCAT is transmitting real-time data: 9.1 mA if transmitting real-time data, 7.9 mA if not. Pump current is 0.025 Amp-seconds per pulse (1.0 second pulse). Quiescent current is 30 microAmps (0.26 Amp-hours per year).

Acquisition time is shown above in *Sample Timing*. The time required for each sample is dependent on the user-programmed sampling mode, and inclusion of a pressure sensor in the MicroCAT. So, battery pack endurance is highly dependent on the application. An example is shown below. **You can use the Deployment Endurance Calculator** to determine the maximum deployment length, instead of performing the calculations by hand.

Example: A MicroCAT with pressure sensor is set up to sample autonomously every 5 minutes (12 samples/hour), and is not transmitting real-time data. How long can it be deployed?

Sampling time (autonomous sampling, with pressure sensor) = 2.6 seconds

Sampling current consumption = 0.0079 Amps * 2.6 seconds = 0.021 Amp-seconds/sample

In 1 hour, sampling current consumption = 12 * 0.021 Amp-seconds/sample = **0.25 Amp-seconds/hour**

Pump current consumption = 0.025 Amp-seconds/pulse

In 1 hour, pump current consumption = 12 * 0.025 Amp-seconds/pulse = **0.3 Amp-seconds/hour**

Quiescent current = 30 microAmps = 0.03 mA

In 1 hour, quiescent current consumption ≈ 0.03 mA * 3600 seconds/hour = **0.11 Amp-seconds/hour**

Total current consumption / hour = 0.25 + 0.3 + 0.11 = **0.66 Amp-seconds/hour**

Capacity = (6.0 Amp-hours * 3600 seconds/hr) / (0.66 Amp-seconds/hour) = 32727 hours = 1363 days = 3.7 years

However, Sea-Bird recommends that batteries should not be expected to last longer than 2 years in the field.

Number of samples = 32,000 hours * 12 samples/hour = 380,000 samples

External Power

The MicroCAT can be powered from an external source that supplies 0.25 Amps at 9-24 VDC. The internal lithium battery pack is diode-OR'd with the external source, so power is drawn from whichever voltage source is higher. The MicroCAT can also be operated from the external supply without having the battery pack installed. Electrical isolation of conductivity prevents ground loop noise contamination in the conductivity measurement.

Note:

See *Real-Time Data Acquisition* in *Section 4: Deploying and Operating MicroCAT* for baud rate limitations on cable length if transmitting real-time data.

Note:

Common wire resistances:

Gauge	Resistance (ohms/foot)
12	0.0016
14	0.0025
16	0.0040
18	0.0064
19	0.0081
20	0.0107
22	0.0162
24	0.0257
26	0.0410
28	0.0653

Cable Length and External Power

There are two issues to consider if powering the MicroCAT externally:

- Limiting the communication IR loss to 1 volt **if transmitting real-time data**; higher IR loss will cause the instrument to transmit data that does not meet the RS-232 communication standard.
- Supplying enough power at the power source so that sufficient power is available at the instrument after considering IR loss.

Each issue is discussed below.

Limiting Communication IR Loss to 1 Volt if Transmitting Real-Time Data

The limit to cable length is typically reached when the maximum **communication** current times the power common wire resistance is more than 1 volt.

$$V_{\text{limit}} = 1 \text{ volt} = IR_{\text{limit}}$$

$$\text{Maximum cable length} = R_{\text{limit}} / \text{wire resistance per foot}$$

where I = communication current required by MicroCAT (4.3 milliAmps; see *Specifications*).

Example 1 – For 20 gauge wire, what is maximum distance to transmit power to MicroCAT if transmitting real-time data?

For 4.3 milliAmp communications current, $R_{\text{limit}} = V_{\text{limit}} / I = 1 \text{ volt} / 0.0043 \text{ Amps} = 232 \text{ ohms}$

For 20 gauge wire, resistance is 0.0107 ohms/foot.

Maximum cable length = $232 \text{ ohms} / 0.0107 \text{ ohms/foot} = 21734 \text{ feet} = 6626 \text{ meters}$

Example 2 – Same as above, but there are 4 MicroCATs powered from the same power supply.

For 4.3 milliAmp communications current, $R_{\text{limit}} = V_{\text{limit}} / I = 1 \text{ volt} / (0.0043 \text{ Amps} * 4 \text{ MicroCATs}) = 58 \text{ ohms}$

Maximum cable length = $58 \text{ ohms} / 0.0107 \text{ ohms/foot} = 5433 \text{ feet} = 1656 \text{ meters}$ (to MicroCAT *furthest* from power source)

Supplying Enough Power to MicroCAT

Another consideration in determining maximum cable length is supplying enough power at the power source so that sufficient voltage is available, after IR loss in the cable (**from the 0.25 Amp turn-on transient, two-way resistance**), to power the MicroCAT. The power requirement varies, depending on whether *any* power is drawn from the battery pack:

- Provide at least 10 volts, after IR loss, to prevent the MicroCAT from drawing **any** power from the battery pack (if you do not want to draw down the battery pack): $V - IR \geq 10$ volts
- Provide at least 9 volts, after IR loss, if allowing the MicroCAT to draw down the battery pack or if no battery pack is installed: $V - IR \geq 9$ volts
where I = MicroCAT turn-on transient (0.25 Amps; see *Specifications*).

Example 1 – For 20 gauge wire, what is maximum distance to transmit power to MicroCAT if using 12 volt power source and deploying MicroCAT with no batteries?

$$V - IR \geq 9 \text{ volts} \quad 12 \text{ volts} - (0.25 \text{ Amps}) * (0.0107 \text{ ohms/foot} * 2 * \text{cable length}) \geq 9 \text{ volts}$$

$$3 \text{ volts} \geq (0.25 \text{ Amps}) * (0.0107 \text{ ohms/foot} * 2 * \text{cable length}) \quad \text{Cable length} \leq 560 \text{ ft} = 170 \text{ meters}$$

Note that 170 m << 6626 m (maximum distance if MicroCAT is transmitting real-time data), so IR drop in power is controlling factor for this example. Using a higher voltage power supply or a different wire gauge would increase allowable cable length.

Example 2 – Same as above, but there are 4 MicroCATs powered from same power supply.

$$V - IR \geq 9 \text{ volts} \quad 12 \text{ volts} - (0.25 \text{ Amps} * 4 \text{ MicroCATs}) * (0.0107 \text{ ohms/foot} * 2 * \text{cable length}) \geq 9 \text{ volts}$$

$$3 \text{ volts} \geq (0.25 \text{ Amps} * 4 \text{ MicroCATs}) * (0.0107 \text{ ohms/foot} * 2 * \text{cable length})$$

$$\text{Cable length} \leq 140 \text{ ft} = 42 \text{ meters (to MicroCAT furthest from power source)}$$

Section 3: Preparing MicroCAT for Deployment

This section describes the pre-check procedure for preparing the MicroCAT for deployment. Installation of the battery pack, installation of Sea-Bird software, and testing power and communications are discussed.

Battery Pack Installation

WARNING!

Do not ship the MicroCAT with battery pack installed. See *Shipping Precautions in Section 1: Introduction*.

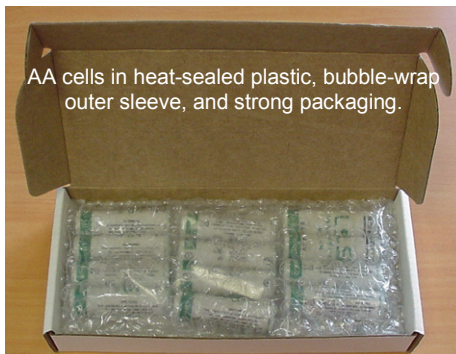

CAUTION:

See *Section 5: Routine Maintenance and Calibration* for handling instructions for the plastic *ShallowCAT* housing.

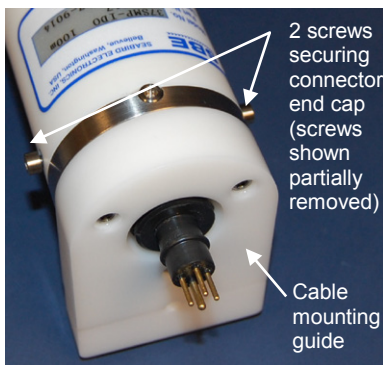

Description of Cells and Battery Pack

Sea-Bird supplies twelve 3.6-volt AA lithium cells, shipped with the MicroCAT in a heat-sealed plastic bag placed in bubble wrap and a cardboard box. The empty cell holder is installed inside the MicroCAT for shipment.

No soldering is required when assembling the battery pack.

Installing Cells and Battery Pack

1. Remove the I/O connector end cap:
 - A. Wipe the outside of the I/O end cap and housing dry, being careful to remove any water at the seam between them.
 - B. Remove the 2 cap screws on the sides of the housing. Do not remove any other screws.
Note: Sea-Bird ships the MicroCAT with a 9/64-inch Allen wrench for these screws.
 - C. Remove the I/O end cap by twisting the end cap counter clockwise; the end cap will release from the housing. Pull the end cap out.
 - D. The end cap is electrically connected to the electronics with a Molex connector. Holding the wire cluster near the connector, pull gently to detach the female end of the connector from the pins.
 - E. Remove any water from the O-ring mating surfaces inside the housing with a lint-free cloth or tissue.
 - F. Put the end cap aside, being careful to protect the O-rings from damage or contamination.

Twist end cap counter clockwise, twisting cap screw out of machined slot; end cap releases from housing.

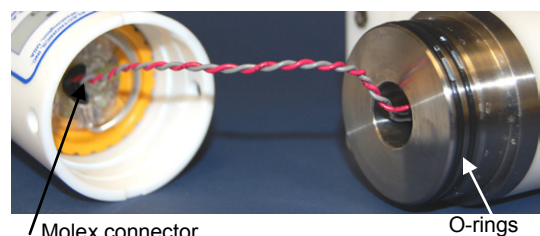
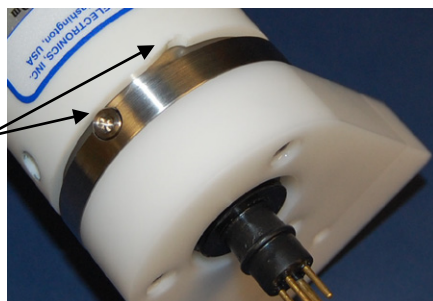

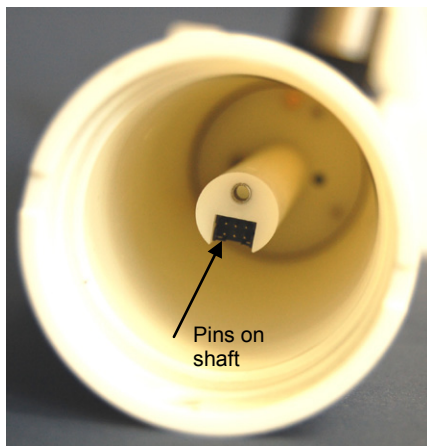
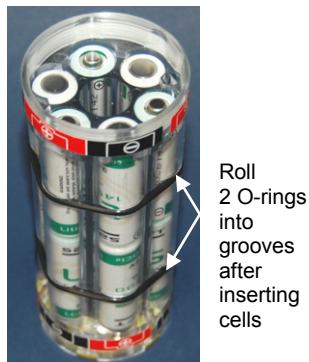
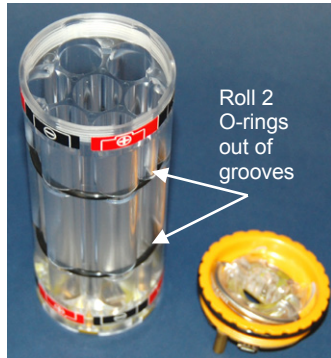
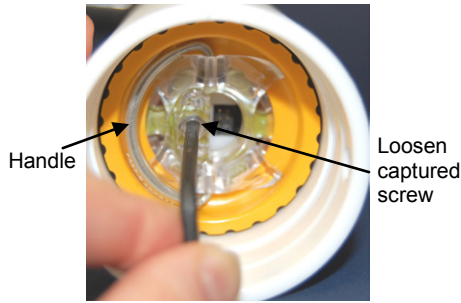

2. Remove the battery pack assembly from the housing:
 - A. Loosen the captured screw from the battery pack cover plate, using the 7/64-inch Allen wrench included with the shipment.
 - B. Lift the battery pack assembly straight out of the housing, using the handle.
3. Keep the handle in an upright position. Holding the edge of the **yellow** cover plate, unscrew the cover plate from the battery pack assembly. Note: Older MicroCATs used a battery pack with a red cover plate; the wiring of that pack is different from this one, and **cannot be used with this MicroCAT**.
4. Roll the 2 O-rings on the outside of the battery pack out of their grooves.
5. Insert each cell into the pack, **alternating** positive (+) end first and negative (-) end first to match the labels on the pack.
6. Roll the 2 O-rings on the outside of the battery pack into place in the grooves. The O-rings compress the side of the battery pack and hold the cells tightly in place in the pack.
7. Reinstall the battery pack cover plate:
 - A. Align the pin on the battery pack cover plate PCB with the post hole in the battery pack housing.
 - B. Place the handle in an upright position. Screw the yellow cover plate onto the battery pack assembly. Ensure the cover is tightly screwed on to provide a reliable electrical contact.
8. Replace the battery pack assembly in the housing:
 - A. Align the D-shaped opening in the cover plate with the pins on the shaft. Lower the assembly slowly into the housing, and once aligned, push gently to mate the banana plugs on the battery compartment bulkhead with the lower PCB. A post at the bottom of the battery compartment mates with a hole in the battery pack's lower PCB to prevent improper alignment.
 - B. Secure the assembly to the shaft with the captured screw, using the 7/64-inch Allen wrench. Ensure the screw is tight to provide a reliable electrical contact.
9. Reinstall the I/O connector end cap:
 - A. Remove any water from the O-rings and mating surfaces in the housing with a lint-free cloth or tissue. Inspect the O-rings and mating surfaces for dirt, nicks, and cuts. Clean as necessary. Apply a light coat of O-ring lubricant (Parker Super O Lube) to the O-rings and mating surfaces.
 - B. Plug the female end of the Molex connector onto the pins.
 - C. Carefully fit the end cap into the housing until the O-rings are fully seated.
 - D. Reinstall the cap screws to secure the end cap.

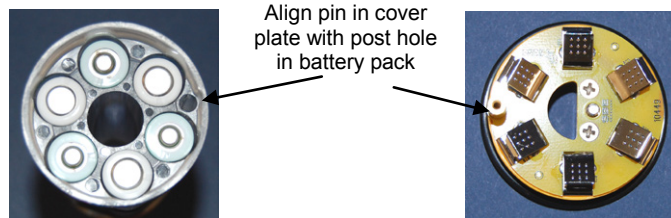

Software Installation

Notes:

- Help files provide detailed information on the software. A separate software manual on the CD-ROM contains detailed information on SBE Data Processing.
- It is possible to use the MicroCAT without the SeatermV2 terminal program by sending direct commands from a dumb terminal or terminal emulator, such as Windows HyperTerminal.
- Sea-Bird supplies the current version of our software when you purchase an instrument. As software revisions occur, we post the revised software on our FTP site. See our website (www.seabird.com) for the latest software version number, a description of the software changes, and instructions for downloading the software from the FTP site.

Seasoft V2 was designed to work with a PC running Windows XP service pack 2 or later, Windows Vista, or Windows 7.

If not already installed, install Sea-Bird software programs on your computer using the supplied software CD:

1. Insert the CD in your CD drive.
2. Install software: Double click on **SeasoftV2.exe**. Follow the dialog box directions to install the software. The installation program allows you to install the desired components. Install all the components, or just install Deployment Endurance Calculator (battery endurance calculator), SeatermV2 (terminal program *launcher* for the MicroCAT), and SBE Data Processing (data processing).

The default location for the software is c:\Program Files\Sea-Bird. Within that folder is a sub-directory for each program.

Power and Communications Test

The power and communications test will verify that the system works, prior to deployment.

Test Setup

1. Remove dummy plug (if applicable):
 - A. By hand, unscrew the locking sleeve from the MicroCAT's bulkhead connector. If you must use a wrench or pliers, be careful not to loosen the bulkhead connector instead of the locking sleeve.
 - B. Remove the dummy plug from the MicroCAT's I/O bulkhead connector by pulling the plug firmly away from the connector.
2. **XSG Connector** - Install the I/O cable connector, aligning the raised bump on the side of the connector with the large pin (pin 1 - ground) on the MicroCAT. **OR**
MCBH Connector – Install the I/O cable connector, aligning the pins.
3. Connect the I/O cable connector to your computer's serial port.

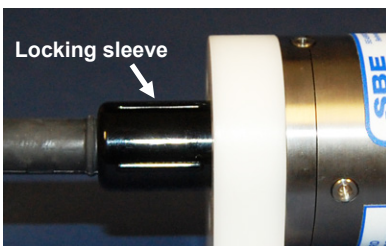
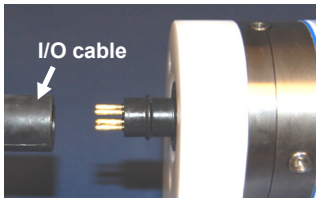

Note:
See SeatermV2's Help files.

Test

1. Double click on **SeatermV2.exe**. The main screen looks like this:

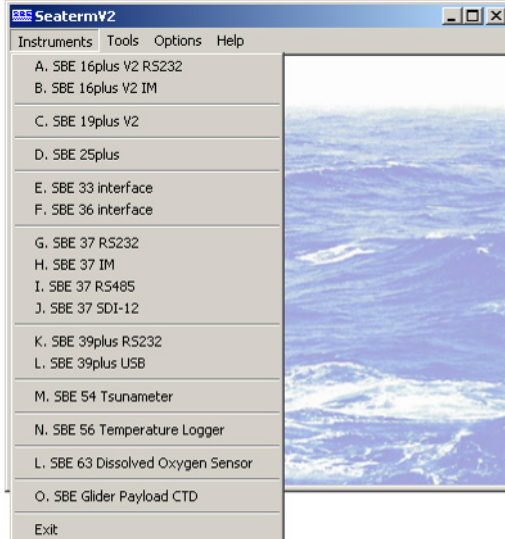

SeatermV2 is a *launcher*, and launches the appropriate terminal program for the selected instrument.

Note:
See Seaterm232's Help files.

2. In the Instruments menu, select *SBE 37 RS232*. **Seaterm232** opens; the main screen looks like this:

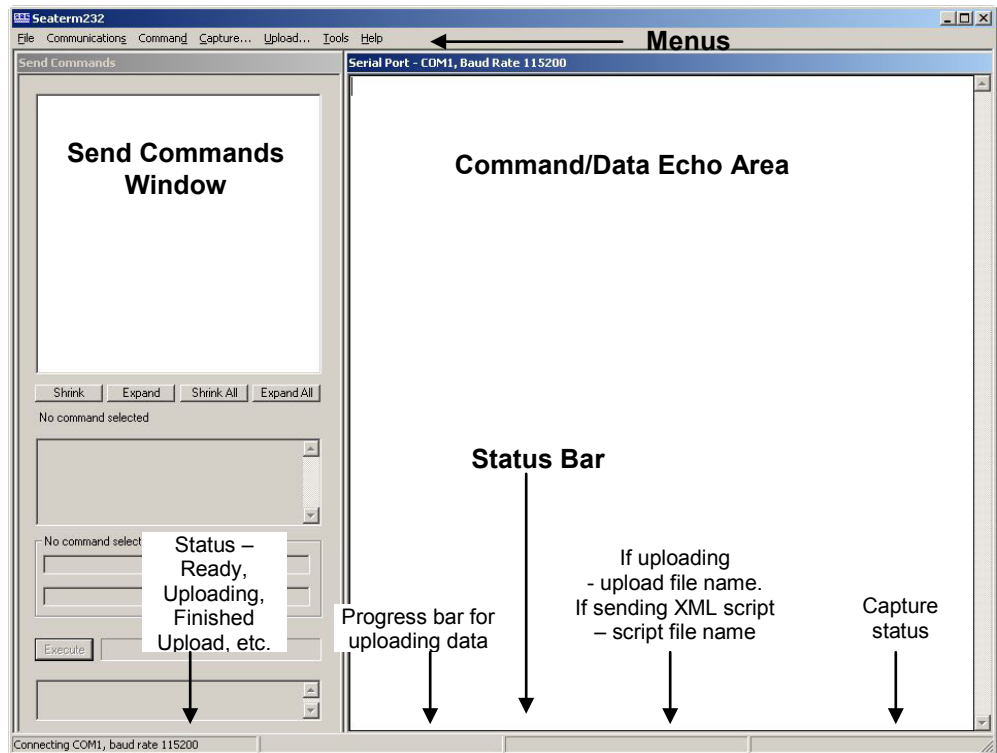

- Menus – For tasks and frequently executed instrument commands.
- Send Commands window – Contains commands applicable to your MicroCAT. The list appears after you connect to the MicroCAT.
- Command/Data Echo Area – Title bar of this window shows Seaterm232's current comm port and baud rate. Commands and the MicroCAT responses are echoed here. Additionally, a command can be manually typed or pasted (ctrl + V) here. Note that the MicroCAT must be *connected* and *awake* for it to respond to a command.
- Status bar – Provides connection, upload, script, and capture status information.

Following is a description of the menus:

Menu	Description	Equivalent Command*
File	<ul style="list-style-type: none"> • Load command file – opens selected .XML command file, and fills Send Commands window with commands. • Unload command file – closes command file, and removes commands from Send Commands window. • Exit - Exit program. 	-
Communications	<ul style="list-style-type: none"> • Configure – Establish communication parameters (comm port and baud rate). • Connect – connect to comm port. • Disconnect – disconnect from comm port. • Disconnect and reconnect – may be useful if instrument has stopped responding. 	-
Command	<ul style="list-style-type: none"> • Abort – interrupt and stop MicroCAT's response. • Send 5 second break (for use with Serial Line Sync mode). • Send stop command. • Set local time– Set date and time to time sent by timekeeping software on your computer; accuracy ± 25 msec of time provided by computer. • Set UTC Time (Greenwich Mean Time) – Set date and time to time sent by timekeeping software on your computer; accuracy ± 25 msec of time provided by computer. 	<ul style="list-style-type: none"> • (press Esc key several times for Abort) • Stop • DateTime= • DateTime=
Capture	Capture instrument responses on screen to file, to save real-time data or use for diagnostics. File has .cap extension. Click Capture menu again to turn off capture. Capture status displays in Status bar.	—
Upload	Upload data stored in memory, in a format that Sea-Bird's data processing software can use. Uploaded data has .xml extension, and is then automatically converted to a .hex and a .xmlcon file that can be used in SBE Data Processing's Data Conversion module. Before using Upload: stop logging by sending Stop .	Several status commands and appropriate data upload command as applicable to user selection of range of data to upload (use Upload menu if you will be processing data with SBE Data Processing)
Tools	<ul style="list-style-type: none"> • Diagnostics log - Keep a diagnostics log. • Convert .XML data file – Using Upload menu automatically does this conversion; tool is available if there was a problem with the automatic conversion. • Send script – Send XML script to MicroCAT. May be useful if you have a number of MicroCATs to program with same setup. 	-

Note:

Set local time and *Set UTC time* are disabled if the baud rate in Seaterm232 is set to 115200, because the software cannot reliably set the time at that baud.

Note:

SeatermV2 with version < 1.1 did not convert the uploaded .xml data file to a .hex and .xmlcon file. *Convert .XML data file* in the Tools menu was used to convert the .xml data file to a .cnv file, which could be processed in SBE Data Processing. We recommend that you update your SeatermV2 software to 1.1b or later.

*See *Command Descriptions* in Section 4: *Deploying and Operating MicroCAT*.

3. If this is the first time Seaterm232 is being used, the configuration dialog box displays:

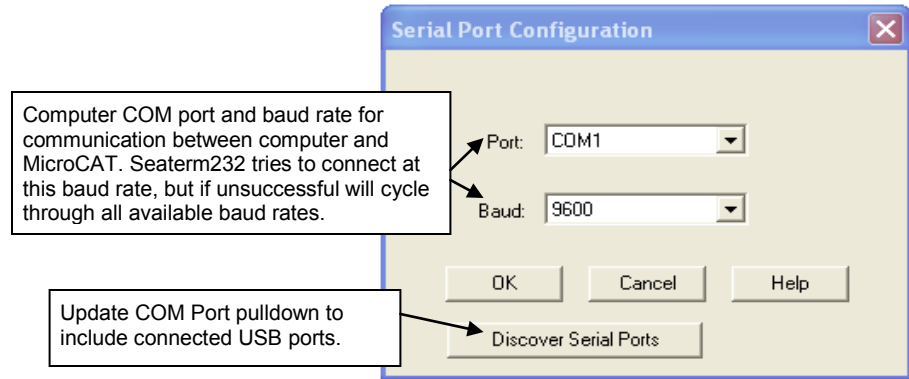

Make the desired selections, and click OK.

Note:

Seaterm232's baud rate must be the same as the MicroCAT baud rate (set with **BaudRate=**). Baud is factory-set to 9600, but can be changed by the user (see *Command Descriptions* in *Section 4: Deploying and Operating MicroCAT*). Other communication parameters – 8 data bits, 1 stop bit, and no parity – cannot be changed.

4. Seaterm232 tries to automatically connect to the MicroCAT. As it connects, it sends **GetHD** and displays the response, which provides factory-set data such as instrument type, serial number, and firmware version. Seaterm232 also fills the Send Commands window with the correct list of commands for your MicroCAT.

If there is no communication:

- A. In the Communications menu, select *Configure*. The Serial Port Configuration dialog box appears. Select the Comm port and baud rate for communication, and click OK. Note that the factory-set baud rate is documented on the Configuration Sheet.
- B. In the Communications menu, select *Connect* (if *Connect* is grayed out, select *Disconnect and reconnect*). Seaterm232 will attempt to connect at the baud specified in Step A, but if unsuccessful will then cycle through all other available baud rates.
- C. If there is still no communication, check cabling between the computer and MicroCAT, and try to connect again.
- D. If there is still no communication, repeat Step A with a different comm port, and try to connect again.

Note:

If **OutputExecutedTag=Y**, the MicroCAT does **not** provide an S> prompt after the **<Executed/>** tag at the end of a command response.

After Seaterm232 displays the **GetHD** response, it provides an S> prompt to indicate it is ready for the next command.

Taking a look at the Send Commands window:

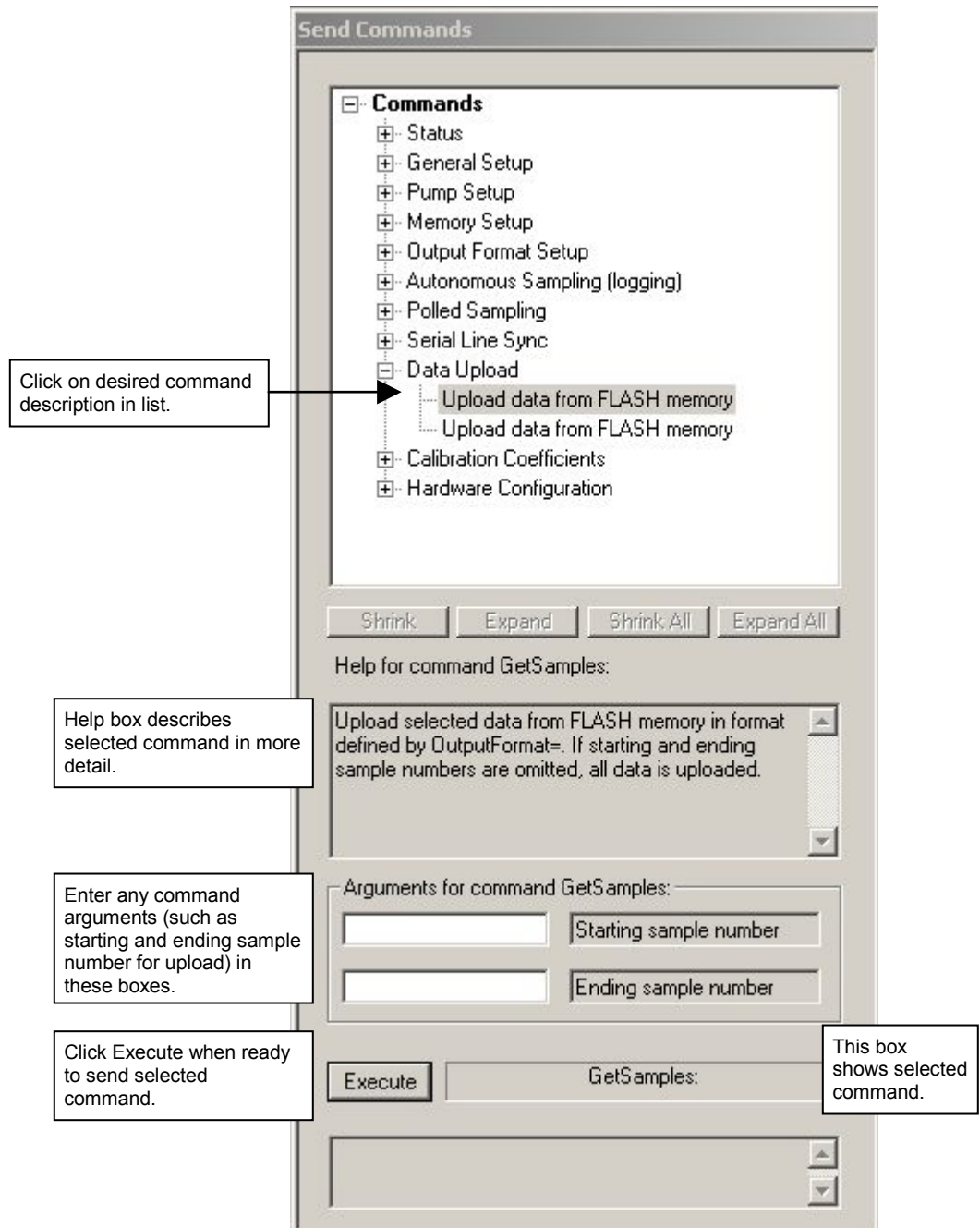

You can use the Send Commands window to send commands, or simply type the commands in the Command/Data Echo area if desired.

Notes:

- The status display indicates *SBE37-SM* because the 37-SMP uses the same firmware as the 37-SM.
- The MicroCAT automatically enters quiescent (sleep) state after 2 minutes without receiving a command. This timeout algorithm is designed to conserve battery pack energy if the user does not send **QS** to put the MicroCAT to sleep. If the system does not appear to respond, select *Connect* in the Communications menu to reestablish communications.

CAUTION:

The MicroCAT **always** runs the pump in response to polled sampling commands (**TS**, etc.), regardless of the conductivity frequency from the last sample and the setting for **MinCondFreq**. **Do not run the pump dry.** The pump is water lubricated; running it without water will damage it. If briefly testing your system with polled sampling commands in dry conditions, orient the MicroCAT to provide an upright U-shape for the plumbing. Then fill the inside of the pump head with water via the pump exhaust tubing. This will provide enough lubrication to prevent pump damage during brief testing.

5. Display MicroCAT status information typing **DS** and pressing the Enter key. The display looks like this:

```
SBE37SM-RS232 4.1 SERIAL NO. 9999 24 Apr 2012 09:48:50
vMain = 13.21, vLith = 3.08
samplenum = 77, free = 559163
not logging, stop command
sample interval = 15 seconds
data format = converted engineering
transmit real-time = yes
sync mode = no
pump installed = yes, minimum conductivity frequency = 3000.0
```

6. Command the MicroCAT to take a sample by typing **TS** and pressing the Enter key. The display looks like this (if pressure sensor installed, **OutputFormat=1**, and you are not outputting salinity or sound velocity):

```
23.7658, 0.00019, 0.062, 24 Apr 2012, 09:51:30
where 23.7658 = temperature in degrees Celsius
0.00019 = conductivity in S/m
0.062 = pressure in decibars
24 Apr 2012 = date
09:51:30 = time
```

These numbers should be reasonable; i.e., room temperature, zero conductivity, barometric pressure (gauge pressure), current date and time (shipped from the factory set to Pacific Daylight or Standard Time).

7. Command the MicroCAT to go to sleep (quiescent state) by typing **QS** and pressing the Enter key.

The MicroCAT is ready for programming and deployment.

Section 4:

Deploying and Operating MicroCAT

This section includes:

- system operation with example sets of operation commands
- baud rate and cable length considerations
- timeout description
- detailed command descriptions
- data output formats
- optimizing data quality / deployment orientation
- deploying and recovering the MicroCAT
- uploading and processing data from the MicroCAT's memory

Sampling Modes

The MicroCAT has three basic sampling modes for obtaining data:

- Polled Sampling – On command, the MicroCAT runs the pump, takes one sample, and transmits data.
- Autonomous Sampling – At pre-programmed intervals, the MicroCAT wakes up, runs the pump, samples, stores data in memory, and goes to sleep. Data is transmitted real-time if **TxRealTime=Y**.
- Serial Line Synchronization – In response to a pulse on the serial line, the MicroCAT wakes up, runs the pump, samples, stores data in memory, and goes to sleep. Data is transmitted real-time if **TxRealTime=Y**.

Commands can be used in various combinations to provide a high degree of operating flexibility.

Note:

In autonomous sampling and serial line sync modes, the pump runs only if the conductivity frequency from the last sample was greater than the minimum conductivity frequency for running the pump (**MinCondFreq**). Checking the conductivity frequency prevents the pump from running in air for long periods of time, which could damage the pump. See *Command Descriptions* for details on setting the minimum conductivity frequency.

The integral pump runs for 1.0 second before every sample measurement. The pump flushes the previously sampled water from the conductivity cell and brings a new water sample quickly into the cell. Water does not freely flow through the conductivity cell between samples, minimizing fouling.

Descriptions and examples of the sampling modes follow. Note that the MicroCAT's response to each command is not shown in the examples. Review the operation of the basic sampling modes and the commands described in *Command Descriptions* before setting up your system.

Polled Sampling

CAUTION:

Do not run the pump dry. The pump is water lubricated; running it without water will damage it. If briefly testing your system in dry conditions, orient the MicroCAT to provide an upright U-shape for the plumbing. Then fill the inside of the pump head with water via the pump exhaust tubing. This will provide enough lubrication to prevent pump damage during brief testing.

On command, the MicroCAT takes a measurement (running the pump for 1.0 second before the measurement), and sends the data to the computer. Storing of data in the MicroCAT's FLASH memory is dependent on the particular command used.

Example: **Polled Sampling** (user input in bold)

Wake up MicroCAT. Set current date and time to December 1, 2012 9 am. Set up to send data in converted decimal format, and include salinity with data. Command MicroCAT to take a sample, and send data to computer (do not store data in MicroCAT's memory). Send power-off command.

(Select *Connect* in Seaterm232's Communications menu to connect and wake up.)

DATE TIME=12012012090000

OUTPUTFORMAT=1

OUTPUTSAL=Y

GETCD (to verify setup)

TS (Pump runs for 1.0 second before measurement.)

QS

When ready to take a sample (repeat as desired): wake up MicroCAT, command it to take a sample and output data, and send power-off command.

(Before first sample, click Capture menu to capture data to a file – Seaterm232 requests file name for data to be stored.)

(Select *Connect* in Seaterm232's Communications menu to connect and wake up.)

TS (Pump runs for 1.0 second before measurement.)

QS

Autonomous Sampling (Logging commands)

At pre-programmed intervals (**SampleInterval=**) the MicroCAT wakes up, runs the pump for 1.0 second (if the conductivity frequency from the last sample was greater than **MinCondFreq=**), samples data, stores the data in its FLASH memory, and goes to sleep (enters quiescent state). Logging is started with **StartNow** or **StartLater**, and is stopped with **Stop**. Transmission of real-time data to the computer is dependent on **TxRealTime**.

Notes:

- If the FLASH memory is filled to capacity, sampling continues, but excess data is not saved in memory (i.e., the MicroCAT does not overwrite the data in memory).
- Use **Stop** to:
 - stop logging.
 - stop waiting to start logging (after **StartLater** has been sent).
 Once **Stop** is sent, the MicroCAT will accept all commands again.

The MicroCAT has a *lockout* feature to prevent unintended interference with sampling. If the MicroCAT is logging or is waiting to start logging (**StartLater** has been sent, but logging has not started yet), the MicroCAT will only accept the following commands: **GetCD**, **GetSD**, **GetCC**, **GetEC**, **GetHD**, **DS**, **DC**, **TS**, **TSH**, **SL**, **SLT**, **QS**, and **Stop**.

Additionally, if the MicroCAT is logging, **it cannot be interrupted during a measurement** to accept any commands. If the MicroCAT is logging and appears unresponsive, it may be in the middle of taking a measurement; continue to try to establish communications.

If transmitting real-time data, keep the signal line open circuit or within ± 0.3 V relative to ground to minimize power consumption when not trying to send commands.

Example: Autonomous Sampling (user input in bold).

Wake up MicroCAT. Initialize logging to overwrite previous data in memory. Set current date and time to May 1, 2012 9 am. Set up to sample every 60 seconds. Do not transmit real-time data to computer. Set up to automatically start logging on 10 May 2012 at 12:00:00. Send power-off command after all parameters are entered – system will automatically wake up and go to sleep for each sample.

(Select *Connect* in Seaterm232's Communications menu to connect and wake up.)

INITLOGGING

DATE TIME=05012012090000

SAMPLEINTERVAL=60

TXREALTIME=N

STARTDATE TIME=05102012120000

STARTLATER

GETCD (to verify setup)

GETSD (to verify status is *waiting to start logging*)

QS

After logging begins, look at data from last sample to check results, and then go to sleep:

(Select *Connect* in Seaterm232's Communications menu to connect and wake up.)

SL

QS

When ready to upload all data to computer, wake up MicroCAT, stop sampling, upload data, and then go to sleep:

(Select *Connect* in Seaterm232's Communications menu to connect and wake up.)

STOP

(Click Upload menu – Seaterm232 leads you through screens to define data to be uploaded and where to store it.)

QS

Serial Line Synchronization (Serial Line Sync)

Note:

Use **GetCD** or **DS** to view Serial Line Sync enable/disable status.

Serial Line Sync allows a simple pulse (a single character) on the RS-232 line to initiate a sample. This mode provides easy integration with ADCPs or current meters, which can synchronize MicroCAT sampling with their own without drawing on their battery or memory resources.

If this mode is enabled (**SyncMode=Y**), sending a pulse causes the MicroCAT to wake up, run the pump for 1.0 second (if the conductivity frequency from the last sample was greater than **MinCondFreq=**), take a sample, and store the data in FLASH memory. Transmission of real-time data to the computer is dependent on **TxRealTime**.

Keep the signal line open circuit or within ± 0.3 V relative to ground to minimize power consumption when not trying to send a pulse to take a sample.

Note:

Send 5 second break holds the RS-232 RX line in space state (greater than 3 volts) for 5 seconds.

To disable serial line sync, the MicroCAT must be in the space state when the sample is finished. Disable serial sync mode by selecting *Send 5 second break* in Seaterm232's Command menu. This sets sync mode to no in the MicroCAT. Then press any key to wake up the MicroCAT. Once serial line sync mode is disabled (**SyncMode=N**), you can communicate with the MicroCAT using the full range of commands (polled sampling, logging, upload, etc.).

Example: Serial Line Sync (user input in bold)

Wake up MicroCAT. Initialize logging to overwrite previous data in memory. Set current date and time to May 1, 2012 9 am. Set up to send data in converted decimal format, and include salinity with data. Set up to transmit real-time data. Set up to transmit real-time data. Enable serial line sync mode. Send power off command.

(Select *Connect* in Seaterm232's Communications menu to connect and wake up.)

```
INITLOGGING
DATETIME=05012012090000
OUTPUTFORMAT=1
OUTPUTSAL=Y
TXREALTIME=Y
SYNCMODE=Y
GETCD      (to verify setup)
QS
```

When ready to take a sample:

(To save real-time data, click Capture menu to capture data to a file – Seaterm232 requests file name for data to be stored.)

Send a pulse – press any key – to wake up, run pump for 1.0 second, take and transmit 1 sample, store in memory, and go to sleep. Repeat as desired.

When ready to upload all data to computer, disable serial line sync mode, and then upload data and go to sleep:

(In Seaterm232's Command menu, select *Send 5 second break*. MicroCAT disables serial line sync mode [sets **SyncMode=N**]. Then press any key.)

```
GETCD      (to verify MicroCAT is communicating, and that sync mode is set to no)
(Click Upload menu – Seaterm232 leads you through screens to define data to be uploaded and where to store it.)
QS
```

Real-Time Data Acquisition

Notes:

- Baud rate is set with **BaudRate=**. Set **TxRealTime=Y** to output real-time data. See *Command Descriptions*.
- If using external power, see *External Power* in *Section 2: Description of MicroCAT* for power limitations on cable length.

The length of cable that the MicroCAT can drive is dependent on the baud rate. Check the capability of your computer and terminal program before increasing the baud; high baud requires a short cable and good PC serial port with an accurate clock. The allowable combinations are:

Maximum Cable Length (meters)	Maximum Baud Rate
1600	600
800	1200
400	2400
200	4800
100	9600
50	19200
25	38400
16	57600
8	115200

If acquiring real-time data with Seaterm232, click the Capture menu; enter the desired file name in the dialog box, and click Save. Begin sampling. The data displayed in Seaterm232 will be saved to the designated file. Process the data as desired. Note that this file **cannot be processed by SBE Data Processing, as it does not have the required headers and format for Sea-Bird's processing software**. To process data with SBE Data Processing, upload the data from the MicroCAT's memory

Timeout Description

The MicroCAT has a timeout algorithm. If the MicroCAT does not receive a command for 2 minutes, it powers down its communication circuits to prevent exhaustion of the battery pack. This places the MicroCAT in quiescent state, drawing minimal current. **To re-establish control (wake up), select *Connect* in Seaterm232's Communications menu or press the Enter key.**

Command Descriptions

This section describes commands and provides sample outputs. Entries made with the commands are permanently stored in the MicroCAT and remain in effect until you change them. See *Appendix III: Command Summary* for a summarized command list.

When entering commands:

- Input commands to the MicroCAT in upper or lower case letters and register commands by pressing the Enter key. Note that commands are shown with a mix of upper and lower case for ease in reading (for example, **InitLogging**), but do not need to be entered that way.
- The MicroCAT sends an error message if an invalid command is entered.
- If a new command is not received within 2 minutes after the completion of a command, the MicroCAT returns to the quiescent (sleep) state.
- If in quiescent (sleep) state, re-establish communications by selecting *Connect* in Seaterm232's Communications menu or pressing the Enter key.
- If the MicroCAT is transmitting data and you want to stop it, press the Esc key or type ^C. Then press the Enter key. Alternatively, select *Abort* in Seaterm232's Command menu.
- The MicroCAT responds only to **GetCD**, **GetSD**, **GetCC**, **GetEC**, **GetHD**, **DS**, **DC**, **TS**, **TSH**, **SL**, **SLT**, **QS**, and **Stop** while sampling autonomously (**StartNow** has been sent). If you wake the MicroCAT while it is sampling (for example, to send **DS** to check on progress), it temporarily stops sampling. Autonomous sampling resumes when it goes back to sleep (either by sending **QS** or after the 2-minute timeout).
- The MicroCAT responds only to **GetCD**, **GetSD**, **GetCC**, **GetEC**, **GetHD**, **DS**, **DC**, **TS**, **TSH**, **SL**, **SLT**, **QS**, and **Stop** while waiting to start autonomous sampling (**StartLater** has been sent). To send any other commands, send **Stop**, send the desired commands to modify the setup, and then send **StartLater** again.

Status Commands

Notes:

- All the status responses indicate *SBE37-SM* because the 37-SMP uses the same firmware as the 37-SM. The internal pump is applicable to the 37-SMP only.
- **GetCD** output does not include calibration coefficients. To display calibration coefficients, use the **GetCC** command.

GetCD

Get and display configuration data, which includes parameters related to MicroCAT setup. Most of these parameters can be user-input/modified. List below includes, where applicable, command used to modify parameter:

- Device type, Serial number
- Pressure sensor installed?
- Reference pressure to use in calculations if no pressure sensor installed (only appears if pressure sensor not installed) [**ReferencePressure=**]
- Pump installed? Always yes for 37-SMP
- Minimum conductivity frequency for pump turn-on [**MinCondFreq=**]
- Output data format [**OutputFormat=**]
- Output salinity with each sample [**OutputSal=**]?
- Output sound velocity with each sample [**OutputSV=**]?
- Transmit autonomous and serial line sync data real-time [**TxRealTime=**]?
- Interval between samples for continuous sampling [**SampleInterval=**]
- Serial sync mode state [**SyncMode=**]

Example: MicroCAT with a pressure sensor (user input in bold, command used to modify parameter in parentheses).

GETCD

```

<ConfigurationData DeviceType = 'SBE37SM-RS232' SerialNumber = '03709999'
  <PressureInstalled>yes</PressureInstalled>           (inclusion of optional pressure sensor set at factory)
  <PumpInstalled>yes</PumpInstalled>                   [only valid setting for 37-SMP]
  <MinCondFreq>3000.0</MinCondFreq>                   [MinCondFreq=]
  <SampleDataFormat>raw Decimal</SampleDataFormat>     [OutputFormat=]
  <OutputSalinity>yes</OutputSalinity>                 [OutputSal=]
  <OutputSV>yes</OutputSV>                             [OutputSV=]
  <TxRealTime>yes</TxRealTime>                         [TxRealTime=]
  <SampleInterval>15</SampleInterval>                 [SampleInterval=]
  <SyncMode>no</Syncmode>                             [SyncMode=]
</ConfigurationData>

```

Status Commands (*continued*)**GetSD**

Get and display status data, which contains data that changes while deployed.

List below includes, where applicable, command used to modify parameter:

- Device type, Serial number
- Date and time [**DateTime=**] in ISO8601-2000 extended format (yyyy – mm-ddThh:mm:ss)
- Number of recorded events in event counter [reset with **ResetEC**]
- Voltages – main battery pack voltage and back-up lithium cell voltage
- Memory – [reset with **InitLogging**]
 - Number of bytes in memory
 - Number of samples in memory
 - Number of additional samples that can be placed in memory
 - Length (number of bytes) of each sample
- Logging status –
 - yes or no (to indicate whether it is currently logging data);
 - if applicable, reason that logging has stopped

Example: (user input in bold, command used to modify parameter in parentheses)

getsd

```

<StatusData DeviceType = 'SBE37SM-RS232' SerialNumber = '03709999'>
  <DateTime>2012-08-20T00:48:32</DateTime>
  <EventSummary numEvents = '0' />
  <Power>
    <vMain> 13.20</vMain>
    <vLith> 3.16</vLith>
  </Power>
  <MemorySummary>
    <Bytes>0</Bytes>
    <Samples>0</Samples>
    <SamplesFree>559240</SamplesFree>
    <SampleLength>15</SampleLength>
  </MemorySummary>
  <AutonomousSampling>no, stop command</AutonomousSampling>
</StatusData>

```

[**DateTime=**]
[can clear with **ResetEC=**]

[can clear with **InitLogging**]
[can clear with **InitLogging**]

[**StartNow** or **StartLater**, **Stop**]

Status Commands (*continued*)**Note:**

Dates shown are when calibrations were performed.

GetCC

Get and display calibration coefficients, which are initially factory-set and should agree with Calibration Certificates shipped with MicroCAT.

Example: MicroCAT with pressure sensor (user input in bold, command used to modify parameter in parentheses)

getcc

```

<CalibrationCoefficients DeviceType = 'SBE37SM-RS232' SerialNumber = '03709999'>
  <Calibration format = 'TEMP1' id = 'Temperature'>
    <SerialNum>03709999</SerialNum>
    <CalDate>04-Apr-12</CalDate> [TCalDate=]
    <A0>6.947802e-05</A0> [TA0=]
    <A1>2.615233e-04</A1> [TA1=]
    <A2>-1.265233e-06</A2> [TA2=]
    <A3>1.310479e-07</A3> [TA3=]
  </Calibration>
  <Calibration format = 'WBCOND0' id = 'Conductivity'>
    <SerialNum>03709999</SerialNum>
    <CalDate>04-Apr-12</CalDate> [CCalDate=]
    <G>-1.009121e+00</G> [CG=]
    <H>1.410162e-01</H> [CH=]
    <I>-2.093167e-04</I> [CI=]
    <J>3.637053e-05</J> [CJ=]
    <PCOR>-9.570000e-08</PCOR> [CTCor=]
    <TCOR>3.250000e-06</TCOR> [CPCor=]
    <WBOTC>1.954800e-05</WBOTC> [CWBOTC=]
  </Calibration>
  <Calibration format = 'STRAIN0' id = 'Pressure'>
    <SerialNum>2478619</SerialNum>
    <CalDate>28-Apr-12</CalDate> [PCalDate=]
    <PA0>1.729067e+00</PA0> [PA0=]
    <PA1>1.415754e-01</PA1> [PA1=]
    <PA2>1.246912e-08</PA2> [PA2=]
    <PTCA0>2.243971e+00</PTCA0> [PTCA0=]
    <PTCA1>1.055267e+00</PTCA1> [PTCA1=]
    <PTCA2>-2.276308e-02</PTCA2> [PTCA2=]
    <PTCB0>1.003849e+02</PTCB0> [PTCB0=]
    <PTCB1>1.014510e-02</PTCB1> [PTCB1=]
    <PTCB2>-2.057110e-04</PTCB2> [PTCB2=]
    <PTEMPA0>5.669780e+01</PTEMPA0> [PTempA0=]
    <PTEMPA1>-5.474043e-02</PTEMPA1> [PTempA1=]
    <PTEMPA2>1.267908e-05</PTEMPA2> [PTempA2=]
    <POFFSET>0.000000e+00</POFFSET> [POffset= (decibars)]
    <PRANGE>0.000000e+00</PRANGE> [PRange= (psi)]
  </Calibration>
</CalibrationCoefficients>

```

Status Commands (*continued*)**GetEC**

Get and display event counter data, which can help to identify root cause of a malfunction. Event counter records number of occurrences of common timeouts, power-on resets, etc. Can be cleared with **ResetEC**. Possible events that may be logged include:

- WDT reset – unexpected reset
- PON reset - power cycled on (each time power is applied)
- ErrorADC12TimeOut – response delayed from A/D converter that measures main power and back-up lithium cell power
- ErrorUART0TimeOut – timeout for transmitter to finish transmitting previous character via RS-232
- ErrorAD7714TimeOut – response delayed from temperature and pressure A/D converter
- ErrorInvWakeUpFlag – unexpected wakeup
- ErrorFLASHTimeOut – problem with writing data to FLASH memory
- Alarm long - time to take next sample is too far in future
- Alarm short - woke up MicroCAT to send a command while logging, and missed taking a sample
- LoggingRestartNoAlarm – no sample taken for 8 hours while logging, restart logging
- LoggingRestartPON – power cycled while logging, logging restarted

Example: (user input in bold, command used to modify parameter in parentheses)

getec

```
<EventCounters DeviceType = 'SBE37SM-RS232' SerialNumber = '03709999'>
  <EventSummary numEvents = '0' /> [can clear with ResetEC]
</EventCounters>
```

ResetEC

Delete all events in event counter (number of events displays in **GetSD** response, and event details display in **GetEC** response).

Status Commands (*continued*)**GetHD**

Get and display hardware data, which is fixed data describing MicroCAT:

- Device type, Serial number
- Manufacturer
- Firmware version
- Firmware date
- PCB assembly numbers and serial numbers
- Manufacture date
- Sensor types and serial numbers

Example: (user input in bold, command used to modify parameter in parentheses)

gethd

```
<HardwareData DeviceType = 'SBE37SM-RS232' SerialNumber = '03709999'>
  <Manufacturer>Sea-Bird Electronics, Inc.</Manufacturer>
  <FirmwareVersion>4.1</FirmwareVersion>
  <FirmwareDate>17 January 2012</FirmwareDate>
  <CommandSetVersion>1.0</CommandSetVersion>
  <PCBAsembly>41720A</PCBAsembly>
  <PCBSerialNum>20736</PCBSerialNum>
  <PCBAsembly>41660B</PCBAsembly>
  <PCBSerialNum>22272</PCBSerialNum>
  <PCBAsembly>41661A</PCBAsembly>
  <PCBSerialNum>20993</PCBSerialNum>
  <MfgDate>17 January 2012</MfgDate>
  <FirmwareLoader>SBE 37-232-V3 FirmwareLoader V 1.0</FirmwareLoader>
  <InternalSensors>
    <Sensor id = 'Temperature'>
      <type>temperature-1</type>
      <SerialNumber>03709999</SerialNumber>
    </Sensor>
    <Sensor id = 'Conductivity'>
      <type>conductivity-1</type>
      <SerialNumber>03709999</SerialNumber>
    </Sensor>
    <Sensor id = 'Pressure'>
      <type>strain-0</type>
      <SerialNumber>2478619</SerialNumber>
    </Sensor>
  </InternalSensors>
</HardwareData>
```

Status Commands (*continued*)**Note:**

The **DS** response contains similar information as the combined responses from **GetSD** and **GetCD**, but in a different format.

DS

Display operating status and setup.

List below includes, where applicable, command used to modify parameter.

- Firmware version, serial number, date and time [**DateTime=**]
- Main battery pack voltage and back-up lithium cell voltage
- Number of samples in memory [**SampleNumber=**] and available sample space in memory
- Logging status (logging not started, logging data, not logging, or unknown)
- Sample interval time [**SampleInterval=**]
- Output format [**OutputFormat=**]
- Output salinity with each sample [**OutputSal=**]? Only displays if set to yes
- Output sound velocity with each sample [**OutputSV=**]? Only displays if set to yes
- Transmit autonomous and serial line sync data real-time [**TxRealTime=**]?
- Serial sync mode state [**SyncMode=**]
- Pump installed (always yes for 37-SMP)? Minimum conductivity frequency for pump turn-on [**MinCondFreq=**]
- Reference pressure to use in calculations if no pressure sensor installed (only appears if pressure sensor not installed) [**ReferencePressure=**]

Example: MicroCAT with a pressure sensor (user input in bold, command used to modify parameter in parentheses).

DS

```

SBE37SM-RS232 4.1 SERIAL NO. 9999 11 Apr 2012 10:55:45           [DateTime=]
vMain = 13.21, vLith = 3.08
samplenumber = 77, free = 559163                                [SampleNumber=]
not logging, stop command
sample interval = 15 seconds                                    [SampleInterval=]
data format = converted engineering                             [OutputFormat=]
output salinity                                                [OutputSal=]
output sound velocity                                          [OutputSV=]
transmit real-time = yes                                       [TxRealTime=]
sync mode = no                                                 [SyncMode=]
pump installed = yes, minimum conductivity frequency = 3000.00 [MinCondFreq=]

```

Status Commands (*continued*)**Notes:**

- The **DC** and **GetCC** responses contain the same information, but in different formats.
- Dates shown are when calibrations were performed.

DC

Display calibration coefficients, which are initially factory-set and should agree with Calibration Certificates shipped with MicroCAT.

Example: MicroCAT with pressure sensor (user input in bold, command used to modify parameter in parentheses).

```

DC
SBE37SM-RS232 V 4.1 9999
temperature: 08-apr-12
TA0 = 6.947802e-05
TA1 = 2.615233e-04
TA2 = -1.265233e-06
TA3 = 1.310479e-07
conductivity: 08-apr-12
G = -1.036689e+00
H = 1.444342e-01
I = -3.112137e-04
J = 3.005941e-05
CPCOR = -9.570001e-08
CTCOR = 3.250000e-06
WBOTC = 1.968100e-05
pressure S/N 2478619, range = 2901 psia, 08-apr-12
  PA0 = 0.000000e+00
  PA1 = 0.000000e+00
  PA2 = 0.000000e+00
  PTCA0 = 0.000000e+00
  PTCA1 = 0.000000e+00
  PTCA2 = 0.000000e+00
  PTCB0 = 0.000000e+00
  PTCB1 = 0.000000e+00
  PTCB2 = 0.000000e+00
  PTEMPA0 = 0.000000e+00
  PTEMPA1 = 0.000000e+00
  PTEMPA2 = 0.000000e+00
  POFFSET = 0.000000e+00

```

[TCalDate=]
[TA0=]
[TA1=]
[TA2=]
[TA3=]
[CCalDate=]
[CG=]
[CH=]
[CI=]
[CJ=]
[CPCor=]
[CTCor=]
[CWBOTC=]
[PRange= (psi), PCalDate=]
[PA0=]
[PA1=]
[PA2=]
[PTCA0=]
[PTCA1=]
[PTCA2=]
[PTCB0=]
[PTCB1=]
[PTCB2=]
[PTempA0=]
[PTempA1=]
[PTempA2=]
[POffset= (decibars)]

General Setup Commands

DateTime=mmddyyyyhhmmss Set real-time clock month, day, year, hour, minute, second.

Example: Set current date and time to 10 September 2012 12:00:00 (user input in bold).

DATE TIME=09102012120000

Notes:

- The MicroCAT baud rate (set with **BaudRate=**) must be the same as Seaterm232's baud rate (set in the Communications menu).
- **BaudRate=** must be sent twice. After the first entry, the MicroCAT changes to the new baud, and then waits for the command to be sent again at the new baud (In Seaterm232's Communications menu, select *Configure*. In the dialog box, select the new baud rate and click OK. Then retype the command.). This prevents you from accidentally changing to a baud that is not supported by your computer. If the MicroCAT does not receive the command again at the new baud, it reverts to the previous baud rate.

BaudRate=x

x= baud rate (600, 1200, 2400, 4800, 9600, 19200, 38400, 57600, or 115200). Default 9600. Check capability of your computer and terminal program before increasing baud; high baud requires a short cable and good PC serial port with accurate clock. **Command must be sent twice to change rate.**

Length of cable that MicroCAT can drive is dependent on baud. See *Real-Time Data Acquisition*.

OutputExecutedTag=x

x=Y: Display XML Executing and Executed tags. Executed tag displays at end of each command response; Executing tag displays one or more times if MicroCAT response to command requires additional time.

x=N: Do not.

Example: Set MicroCAT to output Executed and Executing tags (user input in bold).

```
outputexecutedtag=y
<Executed/>getcd
. . . (GetCD response)
<Executed/>
```

(Note: <Executed/> tag at end of command response takes place of S> prompt.)

Notes:

- The MicroCAT always outputs real-time data for polled sampling.
- **TxRealTime** does not affect storing data to memory, but slightly increases current consumption and time needed to sample (and then transmit) data.
- To capture real-time data to a file, do the following *before* starting logging:
 1. Click the Capture menu in Seaterm232.
 2. Enter the desired file name in the dialog box. The *capture* status displays in the status bar at the bottom of the screen.

TxRealTime=x

x=Y: Output real-time data while sampling autonomously or in serial line sync mode. Data is transmitted immediately after it is sampled. For autonomous sampling, do not set **SampleInterval** < 10 seconds if transmitting real-time data (see *Sample Timing* in Section 2: *Description of MicroCAT*).

x=N: Do not output real-time data.

ReferencePressure=x

x = reference pressure (gauge) in decibars. MicroCAT without installed pressure sensor uses this reference pressure in conductivity (and optional salinity and sound velocity) calculations. Entry ignored if MicroCAT includes pressure sensor.

Note:

The MicroCAT automatically enters quiescent state after 2 minutes without receiving a command. This timeout algorithm is designed to conserve battery pack energy if the user does not send **QS** to put the MicroCAT to sleep.

QS

Quit session and place MicroCAT in quiescent (sleep) state. Main power is turned off. Data logging and memory retention are not affected.

Pump Setup Commands

The SBE 37-SMP MicroCAT has an integral pump that is water lubricated; running it *dry* for an extended period of time will damage it. To prevent the pump from running dry while sampling in autonomous or serial line sync mode, the MicroCAT checks the raw conductivity frequency (Hz) from the last sample against the user-input minimum conductivity frequency (**MinCondFreq=**). If the raw conductivity frequency is greater than **MinCondFreq**, it runs the pump for 1.0 second before taking the sample; otherwise it does not run the pump.

If the minimum conductivity frequency is too close to the *zero conductivity frequency* (from the MicroCAT Calibration Sheet), the pump may turn on when the MicroCAT is in air, as a result of small drifts in the electronics. Some experimentation may be required to control the pump, particularly in fresh water applications.

CAUTION:

The MicroCAT **always** runs the pump in response to a polled sampling command (**TS**, **TSH**, etc.), regardless of the conductivity frequency from the last sample and the setting for **MinCondFreq=**.

MinCondFreq=x

x= minimum conductivity frequency (Hz) to enable pump turn-on for autonomous or serial line sync mode sampling, to prevent pump from running before MicroCAT is in water. Pump does not run when conductivity frequency drops below **MinCondFreq=**. MicroCAT Configuration Sheet lists uncorrected (raw) frequency output at 0 conductivity.

Typical value (and factory-set default) for **MinCondFreq=** for salt water and estuarine applications is:
(zero conductivity frequency + 500 Hz).

Typical value for **MinCondFreq=** for fresh water applications is:
(zero conductivity frequency + 5 Hz).

CAUTION:

Do not run the pump dry. The pump is water lubricated; running it without water will damage it. If briefly testing your system with the **PumpOn** command in dry conditions, orient the MicroCAT to provide an upright U-shape for the plumbing. Then fill the inside of the pump head with water via the pump exhaust tubing. This will provide enough lubrication to prevent pump damage during brief testing.

PumpOn

Turn pump on for testing purposes. Used to test pump or to run it to remove sediment from inside conductivity cell. **Pump runs continuously during test, drawing current.** Send **PumpOff** to stop test.

Note that:

1. MicroCAT does **not** check minimum conductivity frequency when user sends **PumpOn**.
2. **PumpOn** has no effect on pump operation while sampling.

PumpOff

Turn pump off if it was turned on with **PumpOn**. Note that **PumpOff** has no effect on pump operation while sampling.

Notes:

- If the FLASH memory is filled to capacity, sampling continues, but excess data is not saved in memory (i.e., the MicroCAT does not overwrite the data in memory).
- The MicroCAT requires verification when **InitLogging** or **SampleNumber=** are sent. The MicroCAT responds with a request to repeat the command to confirm. Type the command again and press the Enter key to proceed.
- **Do not send InitLogging or SampleNumber=0 until all data has been uploaded.** These commands do not delete the data; they just reset the data pointer. **If you accidentally send one of these commands before uploading,** recover the data as follows:
 1. Set **SampleNumber=x**, where **x** is your estimate of number of samples in memory.
 2. Upload data. If **x** is more than actual number of samples in memory, data for non-existent samples will be bad, random data. Review uploaded data file carefully and delete any bad data.
 3. If desired, increase **x** and upload data again, to see if there is additional valid data in memory.

Memory Setup Commands**InitLogging**

Initialize logging – after all previous data has been uploaded, initialize logging before starting to sample again to make entire memory available for recording.

InitLogging sets sample number (**SampleNumber=**) to 0 (sampling will start with sample 1). If not set to 0, data will be stored after last recorded sample.

Do not send InitLogging until all existing data has been uploaded.

SampleNumber=x

x= sample number for last sample in memory. **SampleNumber=0** is equivalent to **InitLogging**. **Do not send SampleNumber=0 until all existing data has been uploaded.**

Output Format Setup Commands**Notes:**

- See *Data Formats* after the command descriptions for complete details.
- The MicroCAT does not *store* salinity and sound velocity in memory if **OutputSal=Y** and **OutputSV=Y**. It calculates and outputs the values real-time or as data is uploaded; therefore, outputting these parameters has no effect on the number of samples that can be stored in memory.
- Salinity and sound velocity can also be calculated in SBE Data Processing, from data uploaded from the MicroCAT's memory.

OutputFormat=x

x=0: output raw decimal data.

x=1 (default): output converted decimal data.

x=2: output converted decimal data in XML.

x=3: output converted decimal data, alternate format.

OutputSal=x

x=Y: Calculate and output salinity (psu) with each sample. Only applies if **OutputFormat=1, 2, or 3**.

x=N: Do not.

OutputSV=x

x=Y: Calculate and output sound velocity (m/sec) with each sample, using Chen and Millero formula (UNESCO Technical Papers in Marine Science #44). Only applies if **OutputFormat=1, 2, or 3**.

x=N: Do not.

Autonomous Sampling (Logging) Commands

Logging commands direct the MicroCAT to sample data at pre-programmed intervals and store the data in its FLASH memory. Pump operation is dependent on the setting for **MinCondFreq=**.

Notes:

- Do not set **SampleInterval=** to less than 10 seconds if transmitting real-time data (**TxRealTime=Y**).
- If the MicroCAT is logging data and the battery pack voltage is less than 7.1 volts for five consecutive scans, the MicroCAT halts logging.
- If the FLASH memory is filled to capacity, sampling continues, but excess data is not saved in memory (i.e., the MicroCAT does not overwrite the data in memory).

SampleInterval=x

x= interval (seconds) between samples (6 – 21,600). When commanded to start sampling with **StartNow** or **StartLater**, at **x** second intervals MicroCAT takes measurement (running pump for 1.0 second before each measurement), stores data in FLASH memory, transmits real-time data (if **TxRealTime=Y**), and goes to sleep.

StartNow

Start logging now, at rate defined by **SampleInterval=**. Data is stored in FLASH memory. Data is transmitted real-time if **TxRealTime=Y**.

Notes:

- After receiving **StartLater**, the MicroCAT displays `not logging: waiting to start` in reply to **DS**. Once logging has started, the reply displays `logging`.
- If the delayed start date and time has already passed when **StartLater** is received, the MicroCAT executes **StartNow**.
- If the delayed start date and time is more than 30 days in the future when **StartLater** is received, the MicroCAT assumes that the user made an error in setting the delayed start date and time, and it executes **StartNow**.

StartDateTime=mmddyyyyhhmmss

Set delayed logging start month, day, year, hour, minute, second.

StartLater

Start logging at time set with delayed start date and time command, at rate defined by **SampleInterval**. Data is stored in FLASH memory. Data is transmitted real-time if **TxRealTime=Y**.

If you need to change MicroCAT setup after **StartLater** has been sent (but before logging has started), send **Stop**, change setup as desired, and then send **StartLater** again.

Example: Program MicroCAT to start logging on 20 September 2012 12:00:00 (user input in bold).

```
STARTDATETIME=09202012120000
STARTLATER
```

Note:

You may need to send **Stop** several times to get the MicroCAT to respond. This is most likely to occur if sampling with a small **SampleInterval** and transmitting real-time data (**TxRealTime=Y**).

Stop

Stop logging (started with **StartNow** or **StartLater**) or stop waiting to start logging (if **StartLater** was sent but logging has not begun yet). Press any key before entering **Stop**. **Stop** must be sent before uploading data from memory.

Polled Sampling Commands

CAUTION:

The MicroCAT **always** runs the pump in response to polled sampling commands (**TS**, **TSH**, etc.), regardless of the conductivity frequency from the last sample and the setting for **MinCondFreq=**.

Do not run the pump dry. The pump is water lubricated; running it without water will damage it. If briefly testing your system with polled sampling commands in dry conditions, orient the MicroCAT to provide an upright U-shape for the plumbing. Then fill the inside of the pump head with water via the pump exhaust tubing. This will provide enough lubrication to prevent pump damage during brief testing.

These commands are used to request 1 or more samples from the MicroCAT. Unless noted otherwise, the MicroCAT does not store the data in FLASH memory.

TS	Run pump for 1.0 second, take sample, store data in buffer, output data.
TSH	Run pump for 1.0 second, take sample, store data in buffer (do not output data).
TSS	Run pump for 1.0 second, take sample, store data in buffer and in FLASH memory , and output data. Note: MicroCAT ignores this command if sampling data (StartNow or StartLater has been sent).
TSN:x	Run pump continuously while taking x samples and outputting data. To interrupt this sampling, press Esc key. Note: MicroCAT ignores this command if sampling data (StartNow or StartLater has been sent).
SL	Output last sample stored in buffer.
SLT	Output last sample stored in buffer. Then run pump for 1.0 second, take new sample, and store data in buffer (do not output data from new sample).

Note:

The MicroCAT has a buffer that stores the most recent data sample. Unlike data in the FLASH memory, data in the buffer is erased upon removal or failure of power.

Serial Line Sync Commands

SyncMode=x**Note:**

To disable serial line sync mode, select *Send 5 second break* in Seaterm232's Command menu. See *Sampling Modes* above for complete details on the operation of serial line synchronization.

x=Y: Enable serial line sync. When a simple pulse (a single character) is transmitted, MicroCAT runs pump for 1.0 second, takes a sample, stores data in FLASH memory, and goes to sleep. Data is transmitted real-time if **TxRealTime=Y**. Pump operation is dependent on setting for **MinCondFreq=**.

x=N: Disable serial line synchronization.

Data Upload Commands

Stop sampling (send **Stop**) before uploading data.

Notes:

- **Use Seaterm232's Upload menu to upload data that will be processed by SBE Data Processing.** Manually entering a data upload command does not produce data with the required header information for processing by our software. These commands are included here for reference for users who are writing their own software.
- **If not using the Upload menu -**
To save data to a file, click Capture before entering a data upload command.
- See *Data Formats*.

GetSamples:b,e

Upload data from scan **b** to scan **e**, in format defined by **OutputFormat=**. First sample is number 1. As data is uploaded, screen first displays
 start time =
 start sample number =
 These are start time and starting sample number for last set of logged data; can be useful in determining what data to review.

DDb,e

Upload data from scan **b** to scan **e**, in alternate converted decimal form (**OutputFormat=3**) (regardless of **OutputFormat=**). First sample is number 1. As data is uploaded, screen first displays
 start time =,
 start sample number =.
 These are start time and starting sample number for last set of logged data; can be useful in determining what data to review.

Example: Upload samples 1 to 200 to a file (user input in bold).

(Click Capture menu and enter desired filename in dialog box)

GETSAMPLES : 1 , 200

or

DD1 , 200

Calibration Coefficients Commands

Calibration coefficients are initially factory-set and should agree with Calibration Certificates shipped with the MicroCAT

Note:

F = floating point number
S = string with no spaces

Temperature

TCalDate=S	S=Temperature calibration date
TA0=F	F=Temperature A0
TA1=F	F=Temperature A1
TA2=F	F=Temperature A2
TA3=F	F=Temperature A3

Conductivity

CCalDate=S	S=Conductivity calibration date
CG=F	F=Conductivity G
CH=F	F=Conductivity H
CI=F	F=Conductivity I
CJ=F	F=Conductivity J
WBOTC=F	F=Conductivity wbotc
CTCor=F	F=Conductivity ctcor
CPCor=F	F=Conductivity cpcor

Pressure

PCalDate=S	S=Pressure calibration date
PA0=F	F=Pressure A0
PA1=F	F=Pressure A1
PA2=F	F=Pressure A2
PTCA0=F	F=Pressure ptca0
PTCA1=F	F=Pressure ptca1
PTCA2=F	F=Pressure ptca2
PTCB0=F	F=Pressure ptcb0
PTCB1=F	F=Pressure ptcb1
PTCB2=F	F=Pressure ptcb2
PTempA0=F	F=Pressure temperature a0
PTempA1=F	F=Pressure temperature a1
PTempA2=F	F=Pressure temperature a2
POffset=F	F=Pressure offset (decibars)

Data Formats

Notes:

- Time is the time at the **start** of the sample.
- When **TxRealTime=Y**, real-time autonomous data and real-time serial line sync data transmitted to the computer is preceded by a **#** sign.
- The MicroCAT's pressure sensor is an absolute sensor, so its **raw** output includes the effect of atmospheric pressure (14.7 psi). As shown on the Calibration Sheet, Sea-Bird's calibration (and resulting calibration coefficients) is in terms of psia. However, when outputting pressure in **decibars**, the MicroCAT outputs pressure relative to the ocean surface (i.e., at the surface the output pressure is 0 decibars). The MicroCAT uses the following equation to convert psia to decibars:

$$\text{pressure (db)} = [\text{pressure (psia)} - 14.7] * 0.689476$$

Each scan ends with a carriage return <CR> and line feed <LF>.

- **OutputFormat=0**: raw decimal data, intended for diagnostic use at Sea-Bird
 ttttt, cccc.ccc, pppppp, vvvv, dd mmm yyyy, hh:mm:ss

where

ttttt = temperature A/D counts.

cccc.ccc = conductivity frequency (Hz).

pppppp = pressure sensor pressure A/D counts; sent only if pressure sensor installed.

vvvv = pressure sensor pressure temperature compensation A/D counts; sent only if pressure sensor installed.

dd mmm yyyy = day, month, year.

hh:mm:ss = hour, minute, second.

Note that salinity and sound velocity are not sent, regardless of the setting for those parameters. All data is separated with a comma and a space.

Example: Sample data output when pressure sensor is installed, **OutputFormat=0**, **OutputSal=Y**, and **OutputSV=Y**:

524276, 2886.656, 785053, 2706, 20 Aug 2012, 09:01:34
 (temperature, conductivity, pressure sensor pressure, pressure sensor temperature compensation, date, time)

- **OutputFormat=1** (default): converted decimal data
 tttt.tttt,ccc.ccccc,ppppp.ppp,ssss.ssss,vvvvv.vvv, dd mmm yyyy, hh:mm:ss

where

tttt.tttt = temperature (°C, ITS-90).

ccc.ccccc = conductivity (S/m).

ppppp.ppp = pressure (decibars); sent only if pressure sensor installed.

ssss.ssss = salinity (psu); sent only if **OutputSal=Y**.

vvvvv.vvv = sound velocity (meters/second); sent only if **OutputSV=Y**.

dd mmm yyyy = day, month, year.

hh:mm:ss = hour, minute, second.

Leading zeros are suppressed, except for one zero to the left of the decimal point. All data is separated with a comma; date and time are also preceded by a space.

Example: Sample data output when pressure sensor is installed, **OutputFormat=1**, **OutputSal=Y**, **OutputSV=Y**:

8.5796, 0.15269, 531.316, 1.1348, 1451.478, 20 Aug 2012, 09:01:44
 (temperature, conductivity, pressure, salinity, sound velocity, date, time)

Note:

For ease in reading, the data structure is shown with each XML tag on a separate line. However, there are no carriage returns or line feeds between tags (see example below).

- **OutputFormat=2:** converted decimal data in XML

```
<?xml version="1.0"?>
<datapacket>
<hdr>
<mfg>Sea-Bird</mfg>
<model>37sm</model>
<sn>nnnnnnnn</sn>
</hdr>
<data>
<t1>t.t.ttt</t1>
<c1>cc.ccccc</c1>
<p1>pppp.ppp </p1>
<sal>sss.ssss</sal>
<sv>vvvv.vvv</sv>
<dt>yyyy-mm-ddThh:mm:ss</dt>
</data>
</datapacket>
```

where

nnnnnnnn = MicroCAT serial number.

t.t.ttt = temperature (°C, ITS-90).

cc.ccccc = conductivity (S/m).

pppp.ppp = pressure (decibars); sent only if pressure sensor installed.

sss.ssss = salinity (psu); sent only if **OutputSal=Y**.

vvvv.vvv = sound velocity (meters/second); sent only if **OutputSV=Y**.

yyyy-mm-ddThh:mm:ss = year, month, day, hour, minute, second.

Leading zeros are suppressed, except for one zero to the left of the decimal point.

Example: Sample data output when pressure sensor is installed, **OutputFormat=2, OutputSal=Y, OutputSV=Y:**

```
<?xml version="1.0"?><datapacket><hdr><mfg>Sea-Bird</mfg><model>37SM</model>
<sn>03709999</sn></hdr><data><t1> 8.5796</t1><c1> 0.15269</c1><p1> 531.316</p1>
<sal> 1.1348</sal><sv>1451.478</sv><dt>2012-08-20T09:01:44</dt></data></datapacket>
CRLF
```

(temperature, conductivity, pressure, salinity, sound velocity, date and time)

Note:

This format is identical to the format from an SBE 37-SMP with **firmware < 3.0** and **Format=1**. It is provided for compatibility with systems programmed for those older instruments.

- **OutputFormat=3:** converted decimal data, *alternate*

t.t.ttt,cc.ccccc, pppp.ppp, sss.ssss, vvvv.vvv, dd mmm yyyy, hh:mm:ss

where

t.t.ttt = temperature (°C, ITS-90).

cc.ccccc = conductivity (S/m).

pppp.ppp = pressure (decibars); sent only if pressure sensor installed.

sss.ssss = salinity (psu); sent only if **OutputSal=Y**.

vvvv.vvv = sound velocity (meters/second); sent only if **OutputSV=Y**.

dd mmm yyyy = day, month, year.

hh:mm:ss = hour, minute, second.

Leading zeros are suppressed, except for one zero to the left of the decimal point. There is a comma but no space between temperature and conductivity. All other data is separated with a comma and a space.

Example: Sample data output when pressure sensor is installed, **OutputFormat=3, OutputSal=Y, OutputSV=Y:**

8.5796, 0.15269, 531.316, 1.1348, 1451.478, 20 Aug 2012, 09:01:44
(temperature, conductivity, pressure, salinity, sound velocity, date, time)

Optimizing Data Quality / Deployment Orientation

Note:

A pump clogged with sediment results in poor flushing, causing poor quality data.

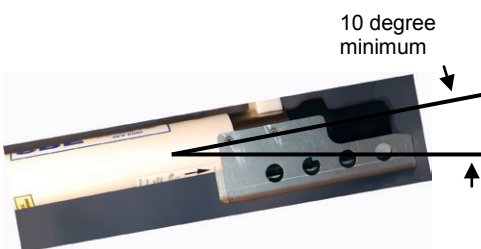
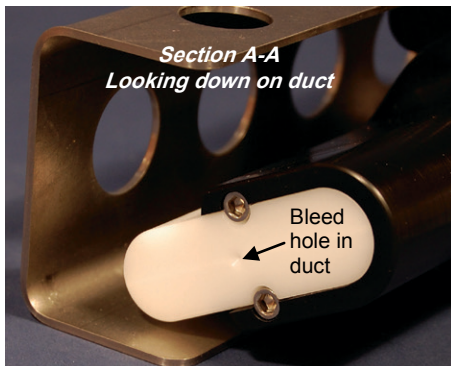
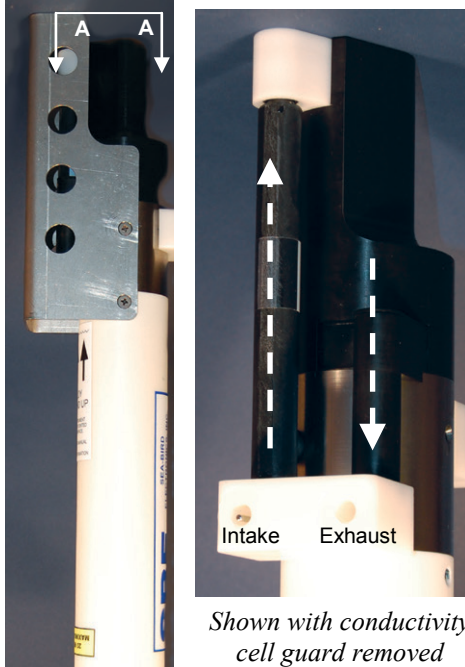

Background Information

Sea-Bird's general recommendation is to deploy the MicroCAT with the plumbing in an **inverted** U-shape, to minimize the ingestion of sediment. A small bleed hole in the duct provides a way for air to exit the plumbing, so that the pump will prime and operate. In considering the effect of air on the pump, it can be instructive to look at the amount of air in the water column:

- **Case 1:** The top ~2 meters of the water column may contain a continuous supply of bubbles injected into the system by breaking waves. In this area, the ability to continuously eliminate air from the system, throughout the deployment, is of prime concern.
- **Case 2:** The next ~30 meters of the water column is not typically affected by bubbles from breaking waves. *Without a bleed hole*, it could take a few days to weeks after deployment for the air to clear out of the system in an inverted U-shape. However, once the air was bled, no more air would be injected into the plumbing.
- **Case 3:** Below ~30 meters, *without a bleed hole*, it could take only a few hours to a day for the air to clear out of the system in an inverted U-shape. As in Case 2, once the air was bled, no more air would be injected into the plumbing.

The bleed hole, while providing a way for air to exit the plumbing, also provides a little more ventilation; this ventilation will cause a slight decrease in the concentration of anti-foulant in the water held in the plumbing between samples. In our judgment, and the experience of customers, the risk of poor data due to sediment accumulation is usually greater than the risk of slightly reduced effectiveness of the anti-foulant, or is at least a reasonable trade-off.

Deployment Recommendations

- **Most deployments** – Deploy the MicroCAT with the plumbing in an **inverted** U-shape (as shown in the photos), allowing air to exit the plumbing through the bleed hole.
- **Deployments where severe bio-fouling is the main concern and sediment is not an issue** –
 - Case A:* You need accurate data immediately upon deployment – Plug the bleed hole. Deploy the MicroCAT with the plumbing in an **upright** U-shape, providing maximum bio-foul protection but leaving the MicroCAT vulnerable to ingestion of sediment.
 - Case B:* You can skip some initial data, allowing time for trapped air to dissolve into the water and the pump to prime properly – **Plug the bleed hole**. Deploy the MicroCAT with the plumbing in an **inverted** U-shape, providing maximum bio-foul protection as well as protection from the ingestion of sediment. This deployment method will provide good data within a day if the deployment is deeper than ~30 meters. Eliminate scans associated with the initial deployment by evaluating the conductivity data; minimal changes in conductivity are an indication that pump flow is not correct because air in the plumbing has prevented the pump from priming.
- **Deployments where air bubbles are the main concern and sediment is not an issue** – **Plug the bleed hole**. Deploy the MicroCAT with the plumbing in an **upright** U-shape. This orientation provides better bleeding of air from the plumbing than can be achieved with the small bleed hole, but leaves the MicroCAT vulnerable to ingestion of sediment.
- **Deployments where (for mounting reasons) the preferred orientation is horizontal** – Sea-Bird does not recommend horizontal mounting, because sediment can accumulate in the conductivity cell, resulting in very poor quality conductivity data. **As a minimum, incline the MicroCAT 10 degrees above the horizontal, with the inlet and exhaust pointing down**, to prevent sediment accumulation and provide proper pump operation.

Setup for Deployment

1. Install new AA lithium cells (see *Section 5: Routine Maintenance and Calibration*) or ensure the existing battery pack has enough capacity to cover the intended deployment.
2. Program the MicroCAT for the intended deployment (see *Section 3: Preparing MicroCAT for Deployment* for connection information; see information in this section on commands and sampling modes):
 - A. Ensure all data has been uploaded, and then send **InitLogging** to make the entire memory available for recording. If **InitLogging** is not sent, data will be stored after the last recorded sample.
 - B. Set the date and time (**DateTime=**).
 - C. Establish the setup and logging parameters.
 - D. Use **one** of the following command sequences to initiate logging:
 - **StartNow** to start logging now, taking a sample every **SampleInterval=** seconds.
 - **StartDateTime=** and **StartLater** to start logging at the specified date and time, taking a sample every **SampleInterval=** seconds.
 - **SyncMode=Y** to place the MicroCAT in serial line sync mode, so that a simple pulse on the RS-232 line will initiate a sample.

Deployment



The MicroCAT comes with a pre-installed Sea-Bird wire mounting clamp and guide.

1. New MicroCATs are shipped with AF24173 Anti-Foulant Devices and a yellow protective label pre-installed.
 - A. Remove the protective label, if installed, from the intake and exhaust. **The label must be removed prior to deployment or pressurization.** If the label is left in place, the flow will be impeded, the sensor will not operate properly, and you may cause severe damage to the conductivity cell.
 - B. Verify that the Anti-Foulant Devices are installed (see *Replacing Anti-Foulant Devices – Mechanical Design Change* in Section 5: *Routine Maintenance and Calibration*).

CAUTIONS:

- Do not use WD-40 or other petroleum-based lubricants, as they will damage the connectors.
- For wet-pluggable MCBH connectors: **Silicone lubricants in a spray can** may contain ketones, esters, ethers, alcohols, or glycols in their propellant. **Do not use these sprays, as they will damage the connector.**

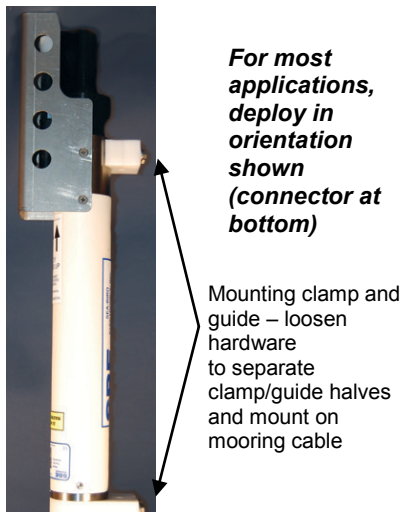
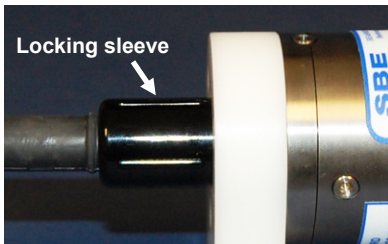
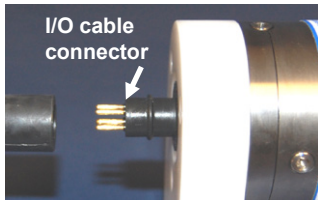

2. Install the dummy plug or I/O cable (for external power and/or serial communication during deployment):
 - A. Lightly lubricate the inside of the dummy plug or cable connector with silicone grease (DC-4 or equivalent).
 - B. **XSG Connector** (shown in photos) - Install the dummy plug or cable connector, aligning the raised bump on the side of the plug/connector with the large pin (pin 1 - ground) on the MicroCAT. Remove any trapped air by *burping* or gently squeezing the plug/connector near the top and moving your fingers toward the end cap. **OR** **MCBH Connector** – Install the plug/cable connector, aligning the pins.
 - C. Place the locking sleeve over the plug/connector. Tighten the locking sleeve finger tight only. **Do not overtighten the locking sleeve and do not use a wrench or pliers.**

3. Attach the mounting clamp and guide to the mooring cable. See *Optimizing Data Quality / Deployment Orientation* for deployment recommendations.

4. Verify that the hardware and external fittings are secure.
5. Deploy the MicroCAT.

Recovery

WARNING!

If the MicroCAT stops working while underwater, is unresponsive to commands, or shows other signs of flooding or damage, carefully secure it away from people until you have determined that abnormal internal pressure does not exist or has been relieved. Pressure housings may flood under pressure due to dirty or damaged o-rings, or other failed seals. When a sealed pressure housing floods at great depths and is subsequently raised to the surface, water may be trapped at the pressure at which it entered the housing, presenting a danger if the housing is opened before relieving the internal pressure. Instances of such flooding are rare. However, a housing that floods at 5000 meters depth holds an internal pressure of more than 7000 psia, and has the potential to eject the end cap with lethal force. A housing that floods at 50 meters holds an internal pressure of more than 85 psia; this force could still cause injury.

If you suspect the MicroCAT is flooded, point it in a safe direction away from people, and loosen the bulkhead connector very slowly, at least 1 turn. This opens an o-ring seal under the connector. Look for signs of internal pressure (hissing or water leak). If internal pressure is detected, let it bleed off slowly past the connector o-ring. Then, you can safely remove the end cap.

1. Rinse the conductivity cell with fresh water. (See *Section 5: Routine Maintenance and Calibration* for cell cleaning and storage.)
2. Install a yellow protective label over the intake and exhaust (1 extra label is included in the spares kit that ships with the MicroCAT).



3. If the battery pack is exhausted, new cells must be installed before the data can be extracted. Stored data will not be lost as a result of exhaustion or removal of the battery pack. See *Section 5: Routine Maintenance and Calibration* for replacement of cells.
4. If immediate redeployment is not required, you can leave the MicroCAT with battery pack in place and in a quiescent state (QS). The quiescent current required is only 30 microAmps (less than 5% loss per year).

Uploading and Processing Data

Note:

Data may be uploaded during deployment or after recovery. If uploading after recovery, connect the I/O cable as described in *Power and Communications Test* in *Section 3: Preparing MicroCAT for Deployment*.

1. Double click on **SeatermV2.exe**. The main screen appears.
2. In the Instruments menu, select *SBE 37 RS232*. **Seaterm232** opens.
3. Seaterm232 tries to automatically connect to the MicroCAT. As it connects, it sends **GetHD** and displays the response. Seaterm232 also fills the Send Commands window with the correct list of commands for your MicroCAT. **If there is no communication:**
 - A. In the Communications menu, select *Configure*. The Serial Port Configuration dialog box appears. Select the Comm port and baud rate for communication, and click OK. Note that the factory-set baud rate is documented on the Configuration Sheet.
 - B. In the Communications menu, select *Connect* (if *Connect* is grayed out, select *Disconnect and reconnect*). Seaterm232 will attempt to connect at the baud specified in Step A, but if unsuccessful will then cycle through all other available baud rates.
 - C. If there is still no communication, check cabling between the computer and MicroCAT.
 - D. If there is still no communication, repeat Step A with a different comm port, and try to connect again.
4. If sampling autonomously, command the MicroCAT to stop logging by pressing any key, typing **Stop**, and pressing the Enter key.
5. Display MicroCAT status information by typing **DS** and pressing the Enter key. The display looks like this:

```
SBE37SM-RS232 4.1 SERIAL NO. 9999 24 Apr 2012 09:48:50
vMain = 13.21, vLith = 3.08
samplenum = 6, free = 559234
not logging, stop command
sample interval = 15 seconds
data format = converted engineering
transmit real-time = yes
sync mode = no
pump installed = yes, minimum conductivity frequency = 3000.0
```

Verify that the status is **not logging**.

Note:

BaudRate= must be sent twice. After the first entry, the MicroCAT changes to the new baud, and then waits for the command to be sent again at the new baud (In Seaterm232's Communications menu, select *Configure*. In the dialog box, select the new baud rate and click OK. Then retype the command.). If it does not receive the command again at the new baud, it reverts to the previous baud rate.

6. If desired, increase the MicroCAT's baud rate for data upload.

7. Click the Upload menu to upload stored data. Seaterm232 responds as follows:
 - A. Seaterm232 sends **GetHD** and displays the response, verifying that it is communicating with the 37-SMP.
 - B. Seaterm232 sends **OutputExecutedTag=Y**; this setting is required for the upload.
 - C. Seaterm232 sends **GetSD** and displays the response, providing information on the number of samples in memory.
 - D. In the Save As dialog box, enter the desired upload file name and click Save. The upload file has a .XML extension
 - E. An Upload Data dialog box appears:

Note:
 If binary upload is selected, Seaterm232 uploads the data in binary and then converts it to ASCII text, resulting in a data file that is identical to one uploaded in ASCII text.

Select number of bytes uploaded in each block. Seaterm232 uploads data in blocks, and calculates a checksum at end of each block. If block fails checksum verification, Seaterm232 tries to upload block of data again, cutting block size in half.

Defines data upload type and range:

- All data as a single file – All data is uploaded into 1 file.
- By scan number range – Enter beginning scan (sample) number and total number of scans. All data within range is uploaded into 1 file.

To change upload file name selected in Step D above, click Browse to navigate to desired upload file path and name. Upload file has a .xml extension. After Seaterm232 uploads data into .xml data file, it creates .hex data file and .xmlcon configuration file that are compatible with SBE Data Processing. These files are placed in same directory as .xml data file, and have same name (but different extensions).

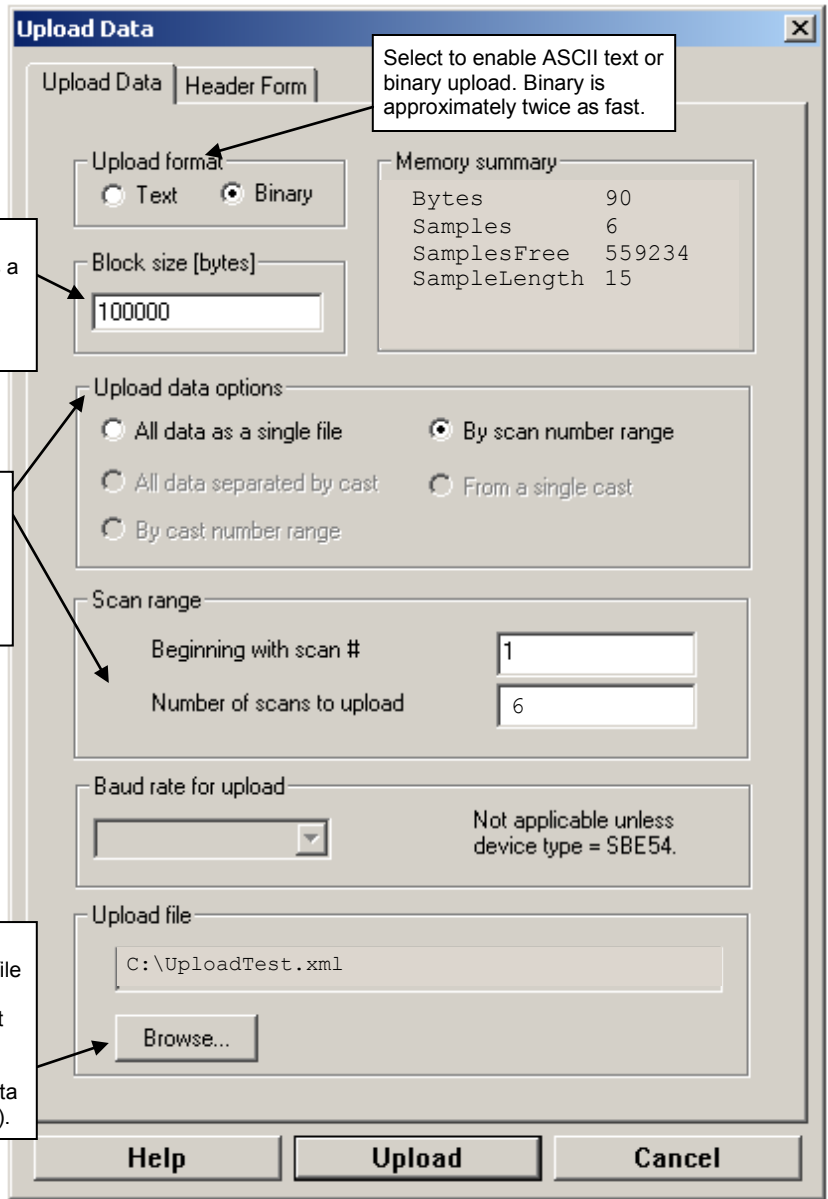

Make the desired selections.

8. Click the Header Form tab to customize the header:

Defines header information included with uploaded data:

- Prompt for header information – As data is uploaded, user is prompted to fill out user-defined header form.
- Include default header form in upload file – User-defined default header form included in upload file. User is not prompted to add any information when data is uploaded.
- Don't include default header form in upload file – Header information not included in upload file.

The entries are free form, 0 to 12 lines long. This dialog box establishes:

- the header prompts that appear for the user to fill in when uploading data, if *Prompt for header information* was selected
- the header included with the uploaded data, if *Include default header form in upload file* was selected

Enter the desired header/header prompts.

9. Click Upload; the Status bar at the bottom of the window displays the upload progress:
- Seaterm232 sends several status commands providing information regarding the number of samples in memory, calibration coefficients, etc., and writes the responses to the upload .xml file.
 - If you selected *Prompt for header information* in the Upload Data dialog box** – a dialog box with the header form appears. Enter the desired header information, and click OK. Seaterm232 writes the header information to the upload .xml file.
 - Seaterm232 sends the data upload command, based on your selection of upload range in the Upload Data dialog box, and writes the data to the upload .xml file.
 - From the information in the .xml file, Seaterm232 creates a .hex data file and .xmlcon configuration file that are compatible with SBE Data Processing for processing and plotting the data. These files are placed in the same directory as the .xml data file and have the same name (but different extensions).

Note:

SeatermV2 with version < 1.1 did not convert the uploaded .xml data file to a .hex and .xmlcon file. *Convert .XML data file* in the Tools menu was used to convert the .xml data file to a .cnv file, which could be processed in SBE Data Processing. We recommend that you update your SeatermV2 software to 1.1b or later.

Notes:

- Ensure all data has been uploaded from the MicroCAT by reviewing the data in SBE Data Processing.
- If you do not run Data Conversion now, you can run it later by opening SBE Data Processing.
- See the SBE Data Processing manual and/or Help for details.

10. After the data has been uploaded, Seaterm232 prompts you to run SBE Data Processing's Data Conversion module if desired. Data Conversion converts the .hex (raw data) file to a .cnv file, which can then be processed by other modules in SBE Data Processing.

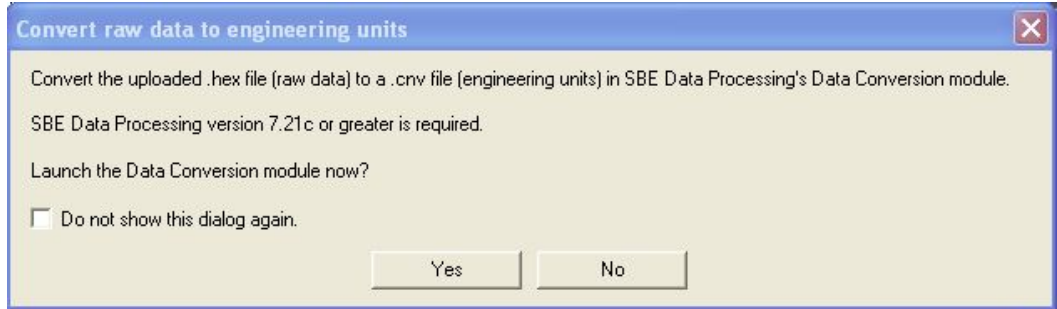

- A. If you click Yes, Seaterm232 opens SBE Data Processing's Data Conversion module, and fills in the appropriate instrument configuration (.xmlcon) file and data (.hex) file on the File Setup tab.

Location to store all setup information. Default is directory with SeatermV2 application data, when Data Conversion is launched from Seaterm232.

Instrument configuration (.xmlcon) file location, which is created by Seaterm232, and contains MicroCAT's calibration coefficients (see dialog box below).

Directory and file name for raw data (.hex) file created by Seaterm232 from uploaded data.

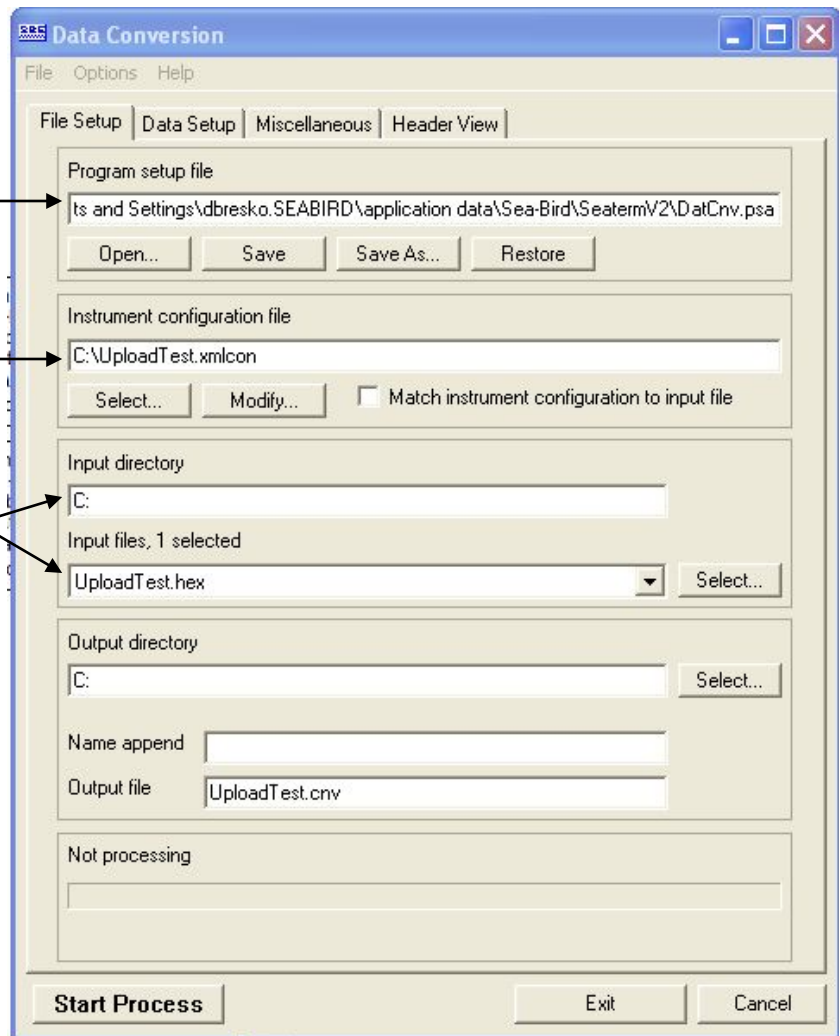

The Configuration dialog box (which appears if you click *Modify* on the File Setup tab) looks like this:

The screenshot shows the 'Configuration for the SBE 37 Microcat' dialog box. It includes the following elements and callouts:

- Configuration file opened:** UploadTest.xmlcon
- Sample interval seconds:** 10. Callout: Time between scans. Must agree with MicroCAT setup (**SampleInterval=**); see reply from **GetCD** or **DS**.
- Pressure sensor:** . Callout: Indicates if MicroCAT includes pressure sensor. If no pressure sensor included, deployment pressure is used to calculate conductivity (and derived variables such as salinity and sound velocity). Value shown is based on **ReferencePressure=** that was programmed into MicroCAT; **you can change this value in .xmlcon file, if you have updated deployment depth information.**
- Oxygen sensor:** None. Callout: Indicates whether MicroCAT includes dissolved oxygen sensor (IDO or ODO MicroCATs only).
- Deployment pressure dbar:** 100
- Deployment latitude:** 0. Callout: Latitude is used to calculate local gravity (to calculate salt water depth). If enabled, software uses input latitude in calculation. If disabled, software uses Latitude on Miscellaneous tab of Data Conversion. **Enter latitude for your deployment.**
- Use deployment latitude in depth calculations:**
- Sensor List Table:**

Channel	Sensor
1. Count	Temperature
2. Frequency	Conductivity
- Buttons:** New, Open..., Save, Save As..., Modify..., Report..., Help..., Exit, Cancel.
- Callout for Temperature sensor:** Double click on sensor to view and/or modify calibration coefficients, which are based on calibration coefficients that were programmed into MicroCAT.

The settings in the .xmlcon file created by Seaterm232 are based on the setup of the MicroCAT.

- Review the deployment latitude, and modify as needed.
- If your MicroCAT does not have a pressure sensor, review the deployment pressure, and modify as needed.

Click Save if you made any changes, and then click Exit.

B. Click on the Data Setup tab.

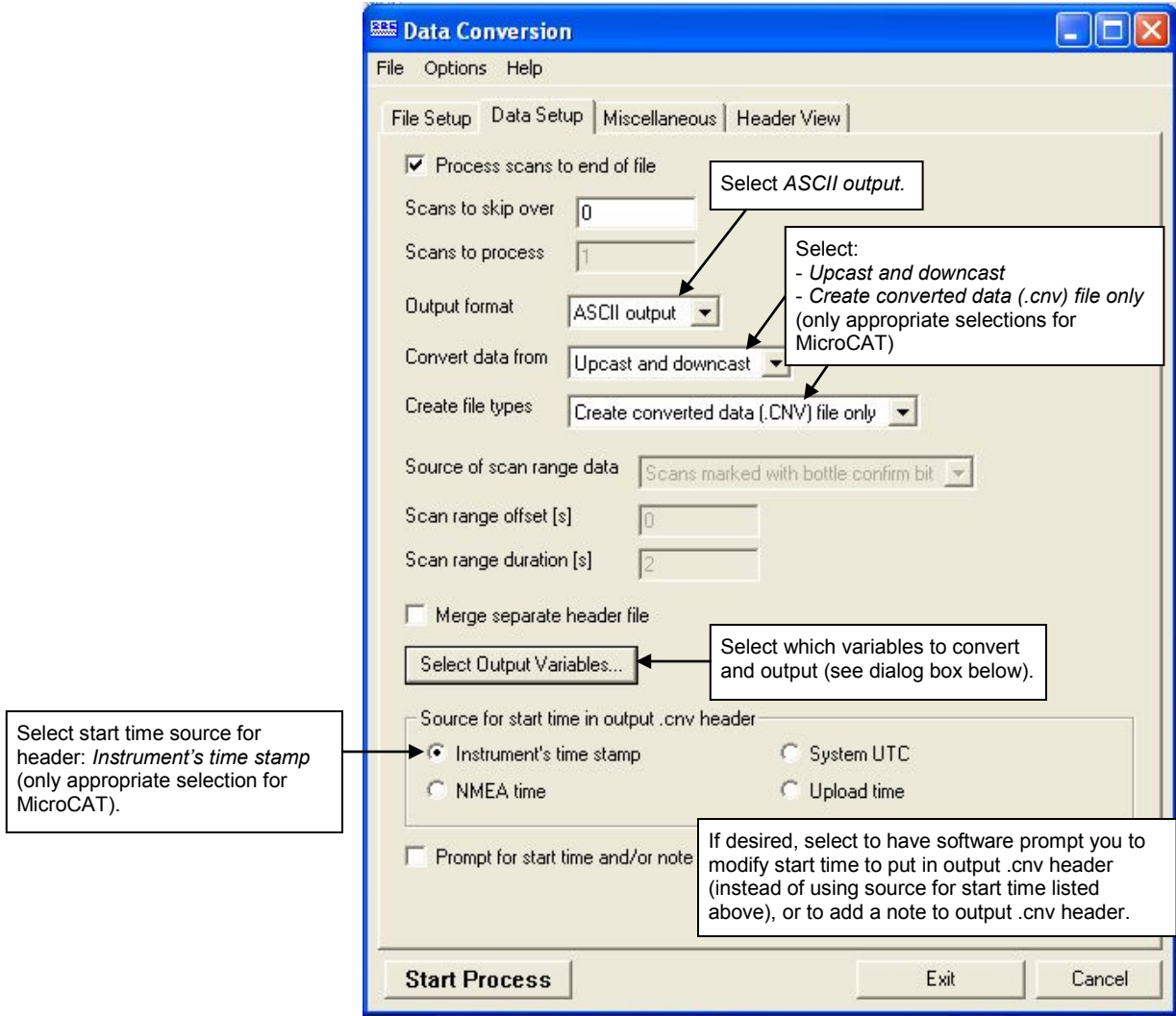

The Select Output Variables dialog box (which appears when you click *Select Output Variables* on the Data Setup tab) looks like this:

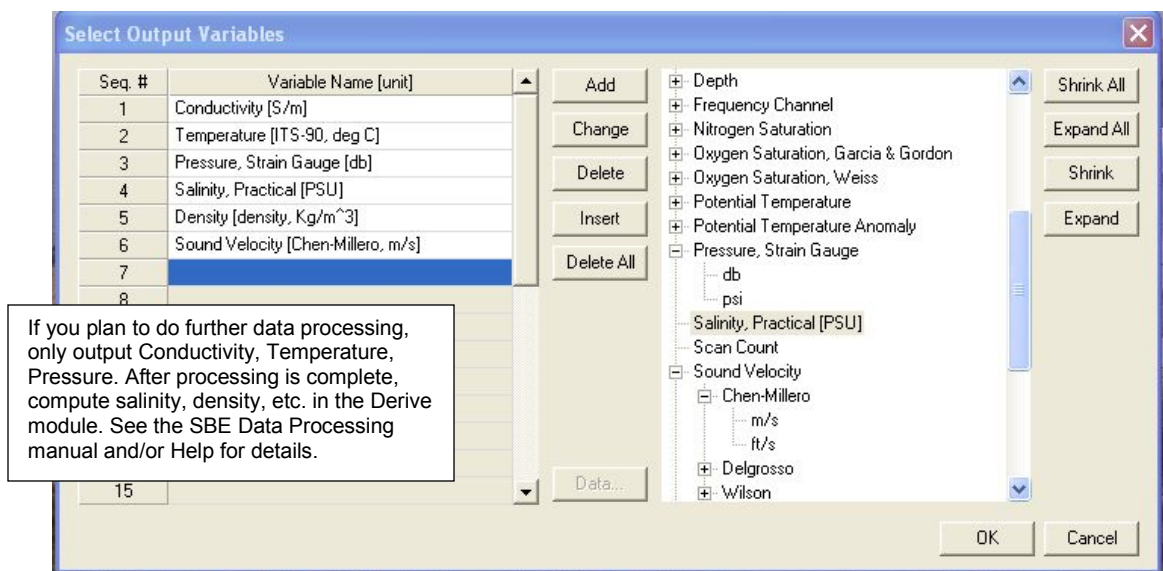

Select Temperature, Conductivity, and Pressure (optional), as well as desired derived variables such as salinity, sound velocity, etc. Click OK.

C. At the bottom of the Data Conversion dialog box, click Start Process to convert the .hex file to a .cnv file.

Notes:

To prepare for re-deployment:

1. After all data has been uploaded, send **InitLogging**. If this is not sent, new data will be stored after the last sample, preventing use of the entire memory.
2. Do *one* of the following:
 - Send **QS** to put the MicroCAT in quiescent (sleep) state until ready to redeploy. Quiescent current is only 30 microAmps, so the battery pack can be left in place without significant loss of capacity.
 - Use **StartNow** to begin logging immediately.
 - Set a date and time for logging to start using **StartDateTime=** and **StartLater**.

11. Once the data is converted to a .cnv file, use the other SBE Data Processing modules as desired:
 - Derive module - Calculate additional derived variables.
 - Sea Plot module - Plot data.

Editing Raw Data File

Sometimes users want to edit the raw .hex data file before beginning processing, to remove data at the beginning of the file corresponding to instrument *soak* time, remove blocks of bad data, edit the header, or add explanatory notes.

Editing the raw .hex file can corrupt the data, making it impossible to perform further processing using Sea-Bird software. Sea-Bird strongly recommends that you first convert the data to a .cnv file (using the Data Conversion module in SBE Data Processing), and then use other SBE Data Processing modules to edit the .cnv file as desired.

Note:

Although we provide this technique for editing a raw .hex file, **Sea-Bird's strong recommendation, as described above, is to always convert the raw data file and then edit the converted file.**

The procedure described below for editing a .hex data file has been found to work correctly on computers running Windows 98, 2000, and NT. **If the editing is not performed using this technique, SBE Data Processing may reject the edited data file and give you an error message.**

1. **Make a back-up copy of your .hex data file before you begin.**
2. Run **WordPad**. In the File menu, select Open. The Open dialog box appears. For *Files of type*, select *All Documents (*.*)*. Browse to the desired .hex file and click Open.
3. Edit the file as desired, **inserting any new header lines after the System Upload Time line**. Note that all header lines must begin with an asterisk (*), and *END* indicates the end of the header. An example is shown below (for an SBE 21), with the added lines in bold:

```
* Sea-Bird SBE 21 Data File:
* FileName = C:\Odis\SAT2-ODIS\oct14-19\oc15_99.hex
* Software Version Seasave Win32 v1.10
* Temperature SN = 2366
* Conductivity SN = 2366
* System Upload Time = Oct 15 1999 10:57:19
* Testing adding header lines
* Must start with an asterisk
* Place anywhere between System Upload Time & END of header
* NMEA Latitude = 30 59.70 N
* NMEA Longitude = 081 37.93 W
* NMEA UTC (Time) = Oct 15 1999 10:57:19
* Store Lat/Lon Data = Append to Every Scan and Append to .NAV
File When <Ctrl F7> is Pressed
** Ship:          Sea-Bird
** Cruise:       Sea-Bird Header Test
** Station:
** Latitude:
** Longitude:
*END*
```
4. In the File menu, select Save (**not Save As**). If you are running Windows 2000, the following message displays:
You are about to save the document in a Text-Only format, which will remove all formatting. Are you sure you want to do this?
Ignore the message and click *Yes*.
5. In the File menu, select Exit.

Section 5: Routine Maintenance and Calibration

This section reviews corrosion precautions, connector mating and maintenance, conductivity cell cleaning and storage, plumbing maintenance, plastic housing handling instructions, replacement of AA cells, pressure sensor maintenance, O-ring maintenance, replacement of AF24173 Anti-Foulant Devices, and sensor calibration. The accuracy of the MicroCAT is sustained by the care and calibration of the sensors and by establishing proper handling practices.

Corrosion Precautions

Rinse the MicroCAT with fresh water after use and prior to storage.

All exposed metal is titanium; other materials are plastic. No corrosion precautions are required, but direct electrical connection of the MicroCAT housing to mooring or other dissimilar metal hardware should be avoided.

Connector Mating and Maintenance

Note:

See *Application Note 57: Connector Care and Cable Installation*.

CAUTIONS:

- Do not use **WD-40** or other petroleum-based lubricants, as they will damage the connectors.
- For wet-pluggable MCBH connectors: **Silicone lubricants in a spray can** may contain ketones, esters, ethers, alcohols, or glycols in their propellant. **Do not use these sprays, as they will damage the connector.**

Clean and inspect the connectors, cable, and dummy plug before every deployment and as part of your yearly equipment maintenance. Inspect connectors that are unmated for signs of corrosion product around the pins, and for cuts, nicks or other flaws that may compromise the seal.

When remating:

1. Lightly lubricate the inside of the dummy plug/cable connector with silicone grease (DC-4 or equivalent).
2. **XSG Connector** - Install the plug/cable connector, aligning the raised bump on the side of the plug/cable connector with the large pin (pin 1 - ground) on the MicroCAT. Remove any trapped air by *burping* or gently squeezing the plug/connector near the top and moving your fingers toward the end cap. **OR**
MCBH Connector – Install the plug/cable connector, aligning the pins.
3. Place the locking sleeve over the plug/cable connector. Tighten the locking sleeve finger tight only. **Do not overtighten the locking sleeve and do not use a wrench or pliers.**

Verify that a cable or dummy plug is installed on the MicroCAT before deployment.

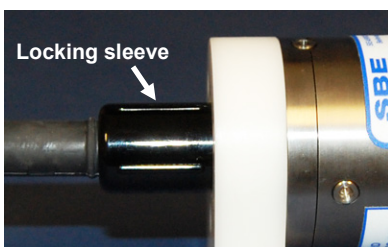
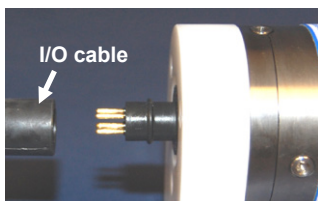

Conductivity Cell Maintenance

CAUTIONS:

- **Do not put a brush or any object inside the plumbing to clean it.** Touching and bending the conductivity cell electrodes can change the calibration. Large bends and movement of the electrodes can damage the cell.
- **Do not store with water in the plumbing.** Freezing temperatures (for example, in Arctic environments or during air shipment) can break the conductivity cell if it is full of water.

The MicroCAT’s conductivity cell and plumbing is shipped dry to prevent freezing in shipping. Refer to *Application Note 2D: Instructions for Care and Cleaning of Conductivity Cells* for conductivity cell cleaning procedures and cleaning materials.

- The Active Use (after each cast) section of the application note is not applicable to the MicroCAT, which is intended for use as a moored instrument.

To rinse or fill the conductivity cell and pump plumbing:

- Hold or clamp the MicroCAT with the connector end up, so that the plumbing is in a U-shape.
- Pour the water or solution through the plumbing with a syringe or wash bottle.

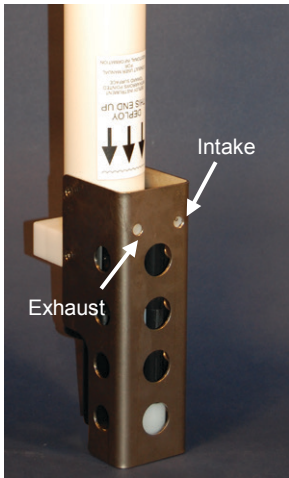

Plumbing Maintenance

A clogged bleed hole can trap air, preventing the pump from functioning properly; this will affect the data quality. Before each deployment, clean the bleed hole with 0.4 mm (0.016 inch) diameter (#26 AWG) wire; a wire is included in the spares kit that ships with the MicroCAT. Insert the wire 13 mm (0.5 inches) into the hole to clean it; verify it is clear by spraying water into the hole.

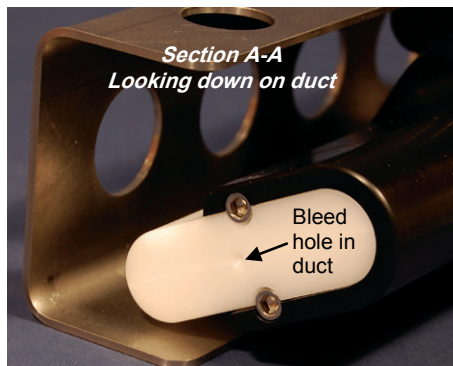

Handling Instructions for Plastic *ShallowCAT*



See detail
below

Hex screw securing connector end
cap (one each side)



Detail - Connector end cap

The MicroCAT's 7000-meter titanium housing offers the best durability with a modest amount of care. The *ShallowCAT*, a 350-meter plastic housing, saves money and weight. However, more care and caution in handling is required. To get the same excellent performance and longevity for the plastic-housing version:

- The MicroCAT's connector end cap is retained by two screws through the side of the housing. The screw holes are close to the end of the housing. Particularly in a cold environment, where plastic is more brittle, the potential for developing a crack around the screw hole(s) is greater for the plastic housing than for the titanium housing. Observe the following precautions –
 - When removing the end cap (to replace the AA cells and/or to access the electronics), be careful to avoid any impact in this area of the housing.
 - When reinstalling the end cap, do not use excess torque on the screws. Sea-Bird recommends tightening the screws to 15 inch-lbs. Alternatively, tighten the screws finger-tight, and then turn each screw an additional 45 degrees.
- A plastic housing is more susceptible to scratches than a titanium housing. Do not use screwdrivers or other metal tools to pry off the end cap.
 - Of primary concern are scratches on O-ring mating and sealing surfaces. Take extra precaution to avoid a scraping contact with these surfaces when replacing AA cells and/or re-seating the end cap.
 - Also take care to keep the O-ring lubricated surfaces clean – avoid trapping any sand or fine grit that can scratch the critical sealing surfaces. If the O-ring lubricant does accumulate any material or grit that can cause a leak or make a scratch, it must be carefully cleaned and replaced with fresh, clean lubricant (Parker Super O Lube).
 - Shallow, external scratches are cosmetic only, and will not affect the performance of the MicroCAT. However, deep external scratches can become points of weakness for deep deployments or fracture from impact during very cold weather.
- If you remove the screws securing the conductivity cell guard to the housing (for example, to change the Anti-Foulant Devices), follow the same precautions as described above for removing and replacing the connector end cap.

See *Battery Pack Installation* in *Section 3: Preparing MicroCAT for Deployment* and *Appendix II: Electronics Disassembly / Reassembly* for detailed step-by-step procedures for removing the MicroCAT's end cap.

Replacing AA Cells

Notes:

- For details and photos, see *Battery Pack Installation* in *Section 3: Preparing MicroCAT for Deployment*.
- **Only use the battery pack with the yellow cover plate.** Older MicroCATs use a battery pack with a red cover plate; those packs are wired differently, and will not work properly in this MicroCAT.
- Cells must be removed before returning the MicroCAT to Sea-Bird. Do not return used cells to Sea-Bird when shipping the MicroCAT for calibration or repair.
- See *Shipping Precautions* in *Section 1: Introduction*.

1. Remove the 2 cap screws holding the I/O connector end cap to the MicroCAT housing. Remove the I/O end cap by twisting the end cap counter clockwise; the end cap will release from the housing. Pull the end cap out.
2. Loosen the captured screw holding the battery pack in the housing, and remove the battery pack from the housing.
3. Place the handle in an upright position. Unscrew the **yellow** cover plate from the top of the battery pack assembly.
4. Roll the 2 O-rings on the outside of the pack out of their grooves.
5. Remove the existing cells. Install new cells, **alternating** positive (+) end first and negative (-) end first to match the labels on the pack.
6. Roll the O-rings into place in the grooves on the side of the battery pack.
7. Place the handle in an upright position. Reinstall the battery pack cover plate.
8. Replace the battery pack assembly in the housing, and secure the assembly with the captured screw. Plug in the Molex connector. Reinstall the MicroCAT end cap, and secure with the 2 cap screws.

Pressure Sensor (optional) Maintenance

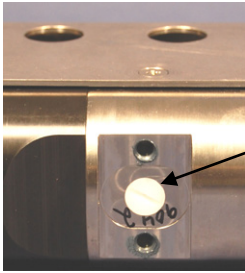

Pressure port plug

The pressure port is located behind the mount clamp. The pressure port plug has a small vent hole to allow hydrostatic pressure to be transmitted to the pressure sensor inside the instrument, while providing protection for the pressure sensor, keeping most particles and debris out of the pressure port.

Periodically (approximately once a year) inspect the pressure port to remove any particles, debris, etc.:

1. Unscrew the pressure port plug from the pressure port.
2. Rinse the pressure port with warm, de-ionized water to remove any particles, debris, etc.
3. Replace the pressure port plug.

CAUTION:

Do not put a brush or any object in the pressure port. Doing so may damage or break the pressure sensor.

O-Ring Maintenance

Note:

For details on recommended practices for cleaning, handling, lubricating, and installing O-rings, see the *Basic Maintenance of Sea-Bird Equipment* module in the Sea-Bird training materials: www.seabird.com/training/TrainingHandouts.htm.

Recommended inspection and replacement schedule:

- For connector end cap O-rings – inspect each time you open the housing to replace the batteries; replace approximately once a year.
- For O-rings that are not normally disturbed (for example, on the electronics end cap) - approximately every 3 to 5 years.

Remove any water from the O-rings and mating surfaces in the housing with a lint-free cloth or tissue. Inspect O-rings and mating surfaces for dirt, nicks, and cuts. Clean or replace as necessary. Apply a light coat of O-ring lubricant (Parker Super O Lube) to O-rings and mating surfaces.

Replacing Anti-Foulant Devices – Mechanical Design Change

The AF24173 Anti-Foulant Devices are installed at the conductivity cell intake and the pump exhaust. Details are provided below on replacing the AF24173 Anti-Foulant Devices. This page provides the mechanical details for the current version of the SBE 37-SMP MicroCAT. The following page, developed for an older version MicroCAT without a pump, provides the precautions and handling details.

CAUTIONS:

- Be careful not to damage the glass conductivity cell or the thermistor when removing / replacing Anti-Foulant Devices.
- If applicable to your MicroCAT, see *Handling Instructions for Plastic ShallowCAT*.

1. Remove the 4 Phillips-head screws holding the conductivity cell guard to the housing. Carefully remove the cell guard.
2. Remove and replace the Anti-Foulant Devices.
3. Carefully replace the cell guard, securing it to the housing with the 4 Phillips-head screws.

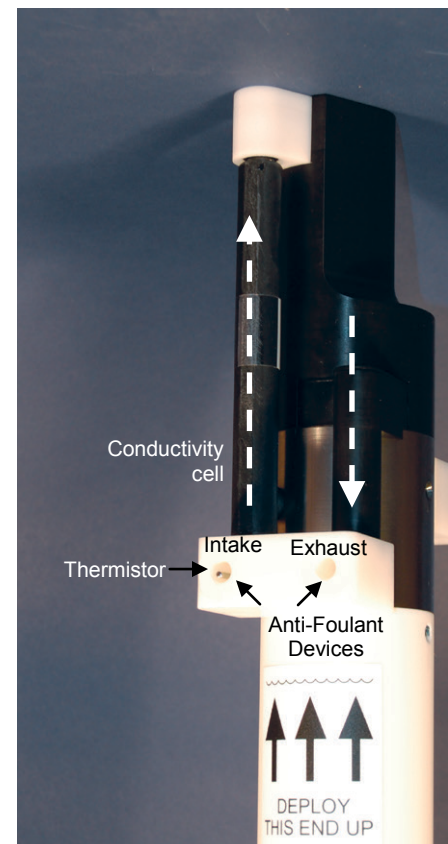
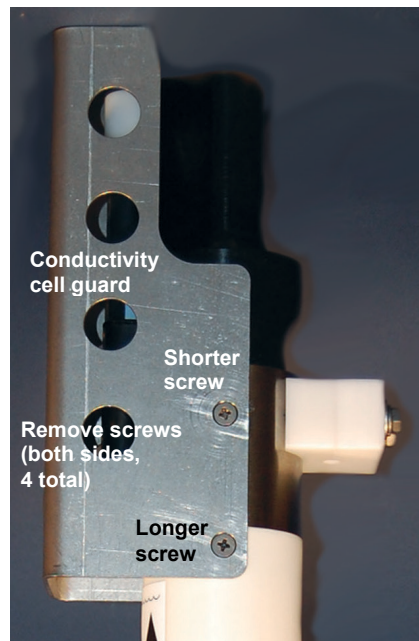

Shown with conductivity cell guard removed

Replacing Anti-Foulant Devices (SBE 37-SI, SM, IM)



AF24173
Anti-Foulant
Device

The MicroCAT has an anti-foulant device cup and cap on each end of the cell. New MicroCATs are shipped with an Anti-Foulant Device and a protective plug pre-installed in each cup.

WARNING!

AF24173 Anti-Foulant Devices contain bis(tributyltin) oxide. Handle the devices only with rubber or latex gloves. Wear eye protection. Wash with soap and water after handling.

Read precautionary information on product label (see Appendix IV) before proceeding.

It is a violation of US Federal Law to use this product in a manner inconsistent with its labeling.

Wearing rubber or latex gloves, follow this procedure to replace each Anti-Foulant Device (two):

1. Remove the protective plug from the anti-foulant device cup;
2. Unscrew the cap with a $\frac{5}{8}$ -inch socket wrench;
3. Remove the old Anti-Foulant Device. If the old device is difficult to remove:

- Use needle-nose pliers and carefully break up material;
- If necessary, remove the guard to provide easier access.

Place the new Anti-Foulant Device in the cup;

4. Rethread the cap onto the cup. Do not over tighten;
5. If the MicroCAT is to be stored, reinstall the protective plug. **Note that the plugs must be removed prior to deployment or pressurization.** If the plugs are left in place during deployment, the cell will not register conductivity. If left in place during pressurization, the cell may be destroyed.

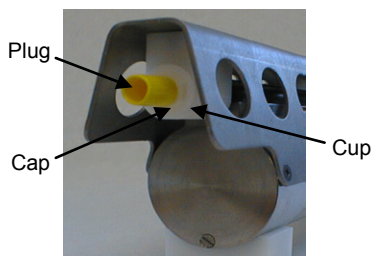
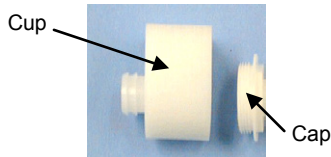

CAUTION:

Anti-foulant device cups are attached to the guard and connected with tubing to the cell. **Removing the guard without disconnecting the cups from the guard will break the cell.** If the guard must be removed:

1. Remove the two screws connecting each anti-foulant device cup to the guard.
2. Remove the four Phillips-head screws connecting the guard to the housing and sensor end cap.
3. Gently lift the guard away.

Sensor Calibration

Notes:

- Cells must be removed before returning the MicroCAT to Sea-Bird. Do not return used cells to Sea-Bird when shipping the MicroCAT for recalibration or repair.
- Please remove AF24173 Anti-Foulant Devices from the anti-foulant device cup before returning the MicroCAT to Sea-Bird. Store them for future use. See *Replacing Anti-Foulant Devices* for removal procedure.

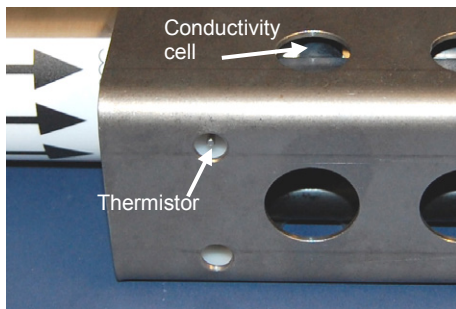

Sea-Bird sensors are calibrated by subjecting them to known physical conditions and measuring the sensor responses. Coefficients are then computed, which may be used with appropriate algorithms to obtain engineering units. The sensors on the MicroCAT are supplied fully calibrated, with coefficients printed on their respective Calibration Certificates (see back of manual). These coefficients have been stored in the MicroCAT's EEPROM.

We recommend that MicroCATs be returned to Sea-Bird for calibration.

Conductivity Sensor Calibration

The conductivity sensor incorporates a fixed precision resistor in parallel with the cell. When the cell is dry and in air, the sensor's electrical circuitry outputs a frequency representative of the fixed resistor. This frequency is recorded on the Calibration Certificate and should remain stable (within 1 Hz) over time.

The primary mechanism for calibration drift in conductivity sensors is the fouling of the cell by chemical or biological deposits. Fouling changes the cell geometry, resulting in a shift in cell constant. Accordingly, the most important determinant of long-term sensor accuracy is the cleanliness of the cell. We recommend that the conductivity sensor be calibrated before and after deployment, but particularly when the cell has been exposed to contamination by oil slicks or biological material.

Temperature Sensor Calibration

The primary source of temperature sensor calibration drift is the aging of the thermistor element. Sensor drift will usually be a few thousandths of a degree during the first year, and less in subsequent intervals. Sensor drift is not substantially dependent upon the environmental conditions of use, and — unlike platinum or copper elements — the thermistor is insensitive to shock.

Pressure Sensor (optional) Calibration

The optional strain-gauge pressure sensor is a mechanical diaphragm type, with an initial static error band of 0.05%. Consequently, the sensor is capable of meeting the MicroCAT's 0.10% error specification with some allowance for aging and ambient-temperature induced drift.

Pressure sensors show most of their error as a linear offset from zero.

A technique is provided below for making small corrections to the pressure sensor calibration using the *offset* (**POffset=**) calibration coefficient term by comparing MicroCAT pressure output to readings from a barometer.

Allow the MicroCAT to equilibrate in a reasonably constant temperature environment for at least 5 hours before starting. Pressure sensors exhibit a transient change in their output in response to changes in their environmental temperature. Sea-Bird instruments are constructed to minimize this by thermally decoupling the sensor from the body of the instrument. However, there is still some residual effect; allowing the MicroCAT to equilibrate before starting will provide the most accurate calibration correction.

Note:

The MicroCAT's pressure sensor is an absolute sensor, so its **raw** output (**OutputFormat=0**) includes the effect of atmospheric pressure (14.7 psi). As shown on the Calibration Sheet, Sea-Bird's calibration (and resulting calibration coefficients) is in terms of psia. However, when outputting pressure in **engineering units**, the MicroCAT outputs pressure relative to the ocean surface (i.e., at the surface the output pressure is 0 decibars). The MicroCAT uses the following equation to convert psia to decibars:

$$\text{Pressure (db)} = [\text{pressure (psia)} - 14.7] * 0.689476$$

1. Place the MicroCAT in the orientation it will have when deployed.
2. In Seaterm232:
 - A. Set the pressure offset to 0.0 (**POffset=0**).
 - B. Set the output format to converted decimal (**OutputFormat=1**), so the pressure output will be in decibars.
 - C. Send **TSN:100** to take 100 samples and transmit data.
3. Compare the MicroCAT output to the reading from a good barometer at the same elevation as the MicroCAT's pressure sensor port. Calculate *offset* = barometer reading – MicroCAT reading
4. Enter the calculated offset (positive or negative) in the MicroCAT's EEPROM, using **POffset=** in Seaterm232.

Offset Correction Example

Absolute pressure measured by a barometer is 1010.50 mbar. Pressure displayed from MicroCAT is -2.5 dbars.

Convert barometer reading to dbars using the relationship: mbar * 0.01 = dbar

Barometer reading = 1010.50 mbar * 0.01 = 10.1050 dbar

The MicroCAT's internal calculations output gage pressure, using an assumed value of 14.7 psi for atmospheric pressure. Convert MicroCAT reading from gage to absolute by adding 14.7 psia to the MicroCAT's output:

-2.5 dbars + (14.7 psi * 0.689476 dbar/psia) = -2.5 + 10.13 = 7.635 dbars

Offset = 10.1050 – 7.635 = + 2.47 dbars

Enter offset in MicroCAT.

For demanding applications, or where the sensor's air ambient pressure response has changed significantly, calibration using a dead-weight generator is recommended. The pressure sensor port uses a ⁷/₁₆-20 straight thread for mechanical connection to the pressure source. Use a fitting that has an O-ring tapered seal, such as Swagelok-200-1-4ST, which conforms to MS16142 boss.

Section 6: Troubleshooting

This section reviews common problems in operating the MicroCAT, and provides the most common causes and solutions.

Problem 1: Unable to Communicate with MicroCAT

If **OutputExecutedTag=N**, the **S>** prompt indicates that communications between the MicroCAT and computer have been established. Before proceeding with troubleshooting, attempt to establish communications again by selecting *Connect* in the Communications menu in Seaterm232 or pressing the Enter key several times.

Cause/Solution 1: The I/O cable connection may be loose. Check the cabling between the MicroCAT and computer for a loose connection.

Cause/Solution 2: The instrument communication settings may not have been entered correctly in Seaterm232. Verify the settings in the Serial Port Configuration dialog box (Communications menu -> *Configure*). The settings should match those on the instrument Configuration Sheet.

Cause/Solution 3: The I/O cable between the MicroCAT and computer may not be the correct one. The I/O cable supplied with the MicroCAT permits connection to standard 9-pin RS-232 interfaces.

Problem 2: No Data Recorded

Cause/Solution 1: The memory may be full; once the memory is full, no further data will be recorded. Verify that the memory is not full using **GetSD** or **DS** (*free = 0* or *1* if memory is full). Sea-Bird recommends that you upload all previous data before beginning another deployment. Once the data is uploaded, send **InitLogging** to reset the memory. After the memory is reset, **GetSD** or **DS** will show *samples = 0*.

Problem 3: Unreasonable T, C, or P Data

The symptom of this problem is a data file that contains unreasonable values (for example, values that are outside the expected range of the data).

Cause/Solution 1: A data file with unreasonable (i.e., out of the expected range) values for temperature, conductivity, or pressure may be caused by incorrect calibration coefficients in the MicroCAT. Send **GetCC** to verify the calibration coefficients in the MicroCAT match the instrument Calibration Certificates. Note that calibration coefficients do not affect the raw data stored in MicroCAT memory.

- If you have not yet overwritten the memory with new data, you can correct the coefficients and then upload the data again.
- If you have overwritten the memory with new data, you can manually correct the coefficients in the .xmlcon configuration file, and then reprocess the data in SBE Data Processing's Data Conversion module.

Cause/Solution 2: Minimal changes in **conductivity** are an indication that the pump flow is not correct. Poor flushing can have several causes:

- Air in the plumbing may be preventing the pump from priming. This can result from:
 - A clogged air bleed hole; clean the air bleed hole (see *Plumbing Maintenance* in *Section 5: Routine Maintenance and Calibration*).
 - Incorrect orientation for a shallow deployment in a location with breaking waves; see *Optimizing Data Quality / Deployment Orientation* in *Section 4: Deploying and Operating MicroCAT*.
- The pump may be clogged by sediment. Using a wash bottle, flush the plumbing to attempt to dislodge the sediment. If the sediment is impacted and you cannot flush it, return the MicroCAT to Sea-Bird for servicing. To minimize ingestion of sediment for future deployments, see *Optimizing Data Quality / Deployment Orientation* in *Section 4: Deploying and Operating MicroCAT*.
- The pump may not be turning on before each sample, if **MinCondFreq** is set too high. See *Command Descriptions* in *Section 4: Deploying and Operating MicroCAT* for details.

Problem 4: Salinity Spikes

Salinity is a function of conductivity, temperature, and pressure, and must be calculated from C, T, and P measurements made on the same parcel of water. Salinity is calculated and output by the 37-SMP if **OutputSal=Y**. Alternatively, salinity can be calculated in SBE Data Processing's Data Conversion module from the data uploaded from memory (.hex file) or in SBE Data Processing's Derive module from the converted (.cnv) file.

[*Background information:* Salinity spikes in **profiling** (i.e., moving, fast sampling) instruments typically result from misalignment of the temperature and conductivity measurements in conditions with sharp gradients. This misalignment is often caused by differences in response times for the temperature and conductivity sensors, and can be corrected for in post-processing if the T and C response times are known.]

In **moored**, pumped instruments such as the 37-SMP MicroCAT, the pump flushes the conductivity cell at a faster rate than the environment changes, so the T and C measurements stay closely synchronized with the environment (i.e., even slow or varying response times are not significant factors in the salinity calculation). More typical causes of salinity spikes in a moored 37-SMP include:

Cause/Solution 1: Severe external bio-fouling can restrict flow through the conductivity cell to such an extent that the conductivity measurement is significantly delayed from the temperature measurement.

Cause/Solution 2: For a MicroCAT moored at shallow depth, differential solar heating can cause the actual temperature inside the conductivity cell to differ from the temperature measured by the thermistor. Salinity spikes associated mainly with daytime measurements during sunny conditions may be caused by this phenomenon.

Cause/Solution 3: For a MicroCAT moored at shallow depth, air bubbles from breaking waves or spontaneous formation in supersaturated conditions can cause the conductivity cell to read low of correct.

Glossary

Note:

The 37-SMP battery pack has a **yellow** cover plate. Older MicroCATs used a battery pack with a red cover plate; the wiring of that pack is different from this one, and cannot be used with this MicroCAT.

Note:

All Sea-Bird software listed was designed to work with a computer running Windows XP service pack 2 or later, Windows Vista, or Windows 7.

Note:

IDO MicroCATs are integrated with SBE 43F DO sensors (Clark polarographic membrane type). **ODO** MicroCATs are integrated with SBE 63 Optical DO sensors.

Battery pack – 12 AA lithium cells in a battery holder that connects 4 cells in series and each series string in parallel. Battery pack uses:

- Saft LS 14500, AA, 3.6 V and 2.6 Amp-hours each (www.saftbatteries.com) (**recommended**),
- Tadiran TL-4903, AA, 3.6 V and 2.4 Amp-hours each (www.tadiran.com), or
- Electrochem 3B0064/BCX85, AA, 3.9 V and 2.0 Amp-hours each (www.electrochemsolutions.com)

Deployment Endurance Calculator – Sea-Bird’s Windows software used to calculate deployment length for moored instruments, based on user-input deployment scheme, instrument power requirements, and battery capacity.

Fouling – Biological growth in the conductivity cell during deployment.

MicroCAT (SBE 37) – High-accuracy conductivity, temperature, and optional pressure Recorder/Sensor. A number of models are available:

- 37-IM (**I**nductive **M**odem, internal battery pack and memory)
- 37-IMP (**I**nductive **M**odem, internal battery pack and memory, integral **P**ump)
- 37-IMP-IDO (**I**nductive **M**odem, internal battery pack and memory, integral **P**ump, **I**ntegrated **D**issolved **O**xygen sensor) – includes internal RS-232 interface
- 37-IMP-ODO (**I**nductive **M**odem, internal battery pack and memory, integral **P**ump, **O**ptical **D**issolved **O**xygen sensor) – includes internal RS-232 interface
- 37-SM (**S**erial interface, internal battery pack and **M**emory)
- 37-SMP (**S**erial interface, internal battery pack and **M**emory, integral **P**ump)
- 37-SMP-IDO (**S**erial interface, internal battery pack and **M**emory, integral **P**ump, **I**ntegrated **D**issolved **O**xygen sensor)
- 37-SMP-ODO (**S**erial interface, internal battery pack and **M**emory, integral **P**ump, **O**ptical **D**issolved **O**xygen sensor)
- 37-SI (**S**erial **I**nterface, memory, no internal battery pack) *
- 37-SIP (**S**erial **I**nterface, integral **P**ump, memory, no internal battery pack) *
- 37-SIP-IDO (**S**erial **I**nterface, integral **P**ump, **I**ntegrated **D**issolved **O**xygen sensor, memory, no internal battery pack)
- 37-SIP-ODO (**S**erial **I**nterface, integral **P**ump, **O**ptical **D**issolved **O**xygen sensor, memory, no internal battery pack)

The serial interface versions are available with RS-232 or RS-485 interface.

Some serial interface versions are also available with an SDI-12 interface.

* Note: Version 3.0 and later of the 37-SI and 37-SIP include memory; earlier versions did not include memory.

PCB – Printed Circuit Board.

SBE Data Processing - Sea-Bird’s Windows data processing software, which calculates and plots temperature, conductivity, and optional pressure, and derives variables such as salinity and sound velocity.

Scan – One data sample containing temperature, conductivity, optional pressure, and date and time, as well as optional derived variables (salinity and sound velocity).

Seasoft V2 – Sea-Bird’s Windows software package, which includes software for communication, real-time data acquisition, and data analysis and display. Seasoft V2 includes *Deployment Endurance Calculator*, *SeatermV2*, and *SBE Data Processing*.

SeatermV2 – Windows terminal program *launcher*, which launches the appropriate terminal program for the selected instrument (Seaterm232 for this MicroCAT).

Seaterm232 – Windows terminal program used with Sea-Bird instruments that communicate via an RS-232 interface, and that were developed or redesigned in 2006 and later. The common feature of these instruments is the ability to output data in XML.

Super O-Lube – Silicone lubricant used to lubricate O-rings and O-ring mating surfaces. Super O-Lube can be ordered from Sea-Bird, but should also be available locally from distributors. Super O-Lube is manufactured by Parker Hannifin (www.parker.com/ead/cm2.asp?cmid=3956).

TCXO – Temperature Compensated Crystal Oscillator.

Triton X-100 – Reagent grade non-ionic surfactant (detergent), used for cleaning the conductivity cell. Triton can be ordered from Sea-Bird, but should also be available locally from chemical supply or laboratory products companies. Triton is manufactured by Avantor Performance Materials (www.avantormaterials.com/commerce/product.aspx?id=2147509608).

Appendix I: Functional Description

Sensors

The MicroCAT embodies the same sensor elements (3-electrode, 2-terminal, borosilicate glass cell, and pressure-protected thermistor) previously employed in our modular SBE 3 and SBE 4 sensors and in the Seacat and Seacat *plus* family.

Note:

Pressure ranges are expressed in meters of deployment depth capability.

The MicroCAT's optional strain-gauge pressure sensor is available in the following pressure ranges: 20, 100, 350, 600, 1000, 2000, 3500, and 7000 meters. Compensation of the temperature influence on pressure offset and scale is performed by the MicroCAT's CPU.

Sensor Interface

Temperature is acquired by applying an AC excitation to a hermetically sealed VISHAY reference resistor and an ultra-stable aged thermistor with a drift rate of less than 0.002°C per year. A 24-bit A/D converter digitizes the outputs of the reference resistor and thermistor (and optional pressure sensor).

AC excitation and ratiometric comparison using a common processing channel avoids errors caused by parasitic thermocouples, offset voltages, leakage currents, and reference errors.

Conductivity is acquired using an ultra-precision Wien Bridge oscillator to generate a frequency output in response to changes in conductivity.

Real-Time Clock

To minimize power and improve clock accuracy, a temperature-compensated crystal oscillator (TCXO) is used as the real-time-clock frequency source. The TCXO is accurate to ± 1 minute per year (0 °C to 40 °C).

Appendix II: Electronics Disassembly/Reassembly

CAUTION:

See Section 5: Routine Maintenance and Calibration for handling instructions for the plastic ShallowCAT housing.

Disassembly:

1. Remove the connector end cap and battery pack following instructions in Section 3: Preparing MicroCAT for Deployment.
2. Remove two screws connecting the conductivity cell guard to the housing. Put one of the removed end cap screws in the machined detail. Remove the housing by twisting the housing counter clockwise; the housing will release.

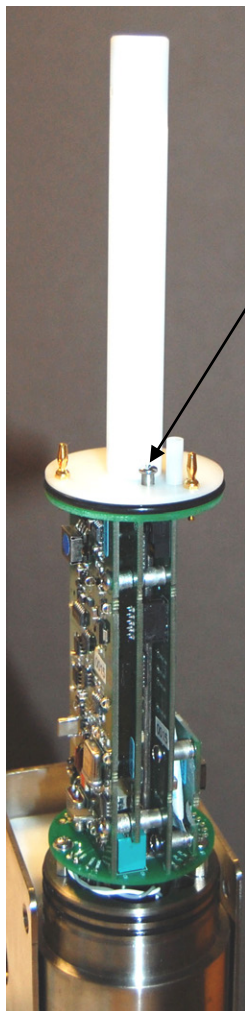
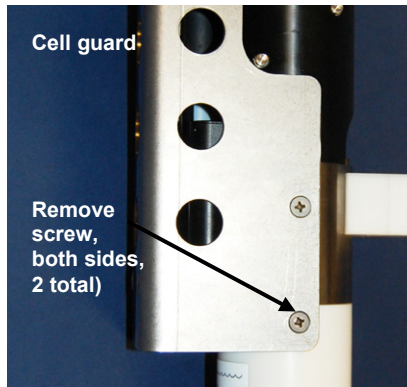

3. The electronics are on a sandwich of three rectangular PCBs. These PCBs are assembled to a bulkhead. To remove the PCB assembly:
 - A. Use a long screwdriver (#1 screwdriver) to remove the Phillips-head screw. The Phillips-head screw is a 198 mm (7.8 inch) threaded rod with Phillips-head.
 - B. Pull out the PCB assembly using the pylon (post with connector). The assembly will pull away from the edge connector used to connect to the sensors. If needed, pull the sandwich of three rectangular PCBs from the bulkhead.

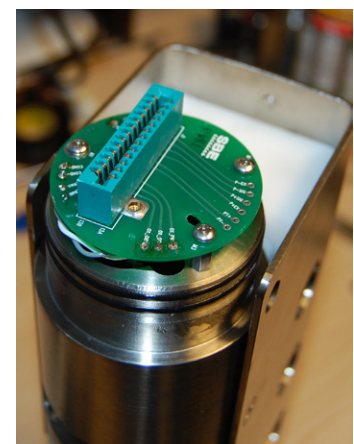
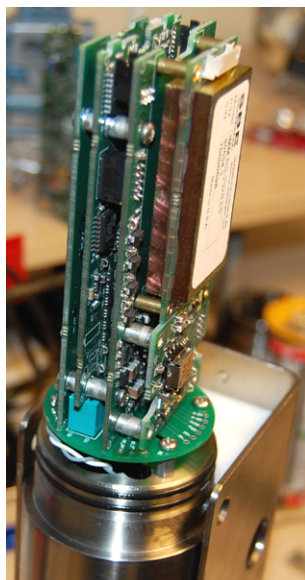

Reassembly:**Note:**

If the rod will not tighten, the PCBs have not fully mated or are mated in reverse.

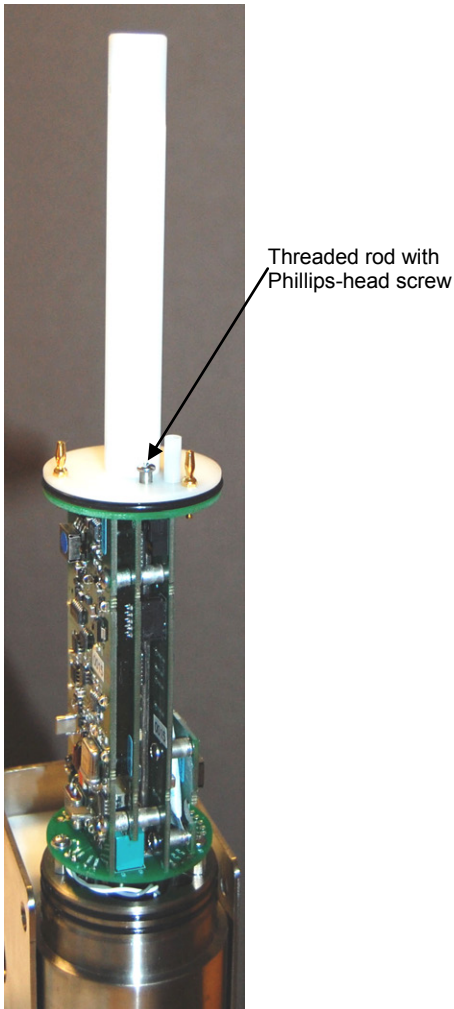

1. Replace all the components as shown at left. Tighten gently the threaded rod with Phillips-head screw. A gentle resistance can be felt as the PCB assembly mates to the edge connector.

2. Replace the housing on the end cap:
 - A. Remove any water from the O-rings and mating surfaces with a lint-free cloth or tissue. Inspect the O-rings and mating surfaces for dirt, nicks, and cuts. Clean as necessary. Apply a light coat of O-ring lubricant (Parker Super O Lube) to the O-rings and mating surfaces.
 - B. Carefully fit the housing onto the housing until the O-rings are fully seated.
 - C. Reinstall the two Phillips-head screws to secure the housing.
3. Reinstall the battery pack and end cap following instructions in *Section 3: Preparing MicroCAT for Deployment*.

Note:

Before delivery, a desiccant package is inserted in the housing and the electronics chamber is filled with dry Argon gas. These measures help prevent condensation. To ensure proper functioning:

1. Install a new desiccant bag each time you open the electronics chamber. If a new bag is not available, see *Application Note 71: Desiccant Use and Regeneration (drying)*.
2. If possible, dry gas backfill each time you open the housing. If you cannot, wait at least 24 hours before redeploying, to allow the desiccant to remove any moisture from the housing.

Note that opening the battery compartment does not affect desiccation of the electronics.

Appendix III: Command Summary

Note:
See *Command Descriptions* in *Section 4: Deploying and Operating MicroCAT* for detailed information and examples.

CATEGORY	COMMAND	DESCRIPTION
Status	GetCD	Get and display configuration data.
	GetSD	Get and display status data.
	GetCC	Get and display calibration coefficients.
	GetEC	Get and display event counter data.
	ResetEC	Reset event counter.
	GetHD	Get and display hardware data.
	DS	Get and display status and configuration data.
	DC	Get and display calibration coefficients.
General Setup	DateTime=mmddyyyymmss	Set real-time clock month, day, year, hour, minute, second.
	BaudRate=x	x= baud rate (600, 1200, 2400, 4800, 9600, 19200, 38400, 57600, or 115200). Default 9600.
	OutputExecutedTag=x	x=Y: Display XML Executing and Executed tags. x=N: Do not.
	TxRealTime=x	x=Y: output real-time data while sampling autonomously or in serial line sync mode. x=N: do not.
	ReferencePressure=x	x= reference pressure (gauge) in decibars (used for conductivity computation when MicroCAT does not have pressure sensor).
	QS	Enter quiescent (sleep) state. Main power turned off, but data logging and memory retention unaffected.
Pump Setup	MinCondFreq=x	x= minimum conductivity frequency (Hz) to enable pump turn-on for autonomous or serial line sync mode sampling.
	PumpOn	Turn pump on for testing or to remove sediment.
	PumpOff	Turn pump off, if turned on with PumpOn .
Memory Setup	InitLogging	Initialize logging to make entire memory available for recording.
	SampleNumber=x	x= sample number for last sample in memory. SampleNumber=0 equivalent to InitLogging .
Output Format Setup	OutputFormat=x	x=0: output raw decimal data. x=1: output converted decimal data x=2: output converted decimal data in XML. x=3: output converted decimal data, alternate format.
	OutputSal=x	x=Y: calculate and output salinity (psu). Only applies if OutputFormat=1, 2, or 3 . x=N: do not.
	OutputSV=x	x=Y: calculate and output sound velocity (m/sec). Only applies if OutputFormat=1, 2, or 3 . x=N: do not.
Autonomous Sampling (Logging)	SampleInterval=x	x= interval (seconds) between samples (6 - 21600). When commanded to start sampling with StartNow or StartLater , at x second intervals MicroCAT runs pump for 1.0 second, takes sample, stores data in FLASH memory, transmits real-time data (if TxRealTime=Y), and goes to sleep.
	StartNow	Start logging now.
	StartDateTime=mmddyyyymmss	Delayed logging start: month, day, year, hour, minute, second.
	StartLater	Start logging at delayed logging start time.
	Stop	Stop logging or stop waiting to start logging. Press Enter key before entering Stop . Must send Stop before uploading data.

Note:
Do not set **SampleInterval=** to less than 10 seconds if transmitting real-time data (**TxRealTime=Y**).

CATEGORY	COMMAND	DESCRIPTION
Polled Sampling	TS	Run pump for 1.0 second, take sample, store in buffer, output data.
	TSH	Run pump for 1.0 second, take sample, store in buffer (do not output).
	TSS	Run pump for 1.0 second, take sample, store in buffer and in FLASH memory, output data.
	TSN:x	Run pump continuously while taking x samples and outputting data.
	SL	Output last sample stored in buffer.
	SLT	Output last sample stored in buffer, then run pump for 1.0 second, take new sample and store in buffer (do not output data from new sample).
Serial Line Sync	SyncMode=x	x=Y: Enable serial line sync mode. x=N: Disable serial line sync mode.
Data Upload (send Stop before sending upload command)	GetSamples:b,e	Upload scan b to scan e, in format defined by OutputFormat=.
	DDb,e	Upload scan b to scan e, in alternate converted decimal form (OutputFormat=3) (regardless of setting for OutputFormat=.)
Coefficients (F=floating point number; S=string with no spaces) Dates shown are when calibrations were performed. Calibration coefficients are initially factory-set and should agree with Calibration Certificates shipped with MicroCATs. View all coefficients with GetCC or DC .	TCalDate=S	S=Temperature calibration date.
	TA0=F	F=Temperature A0.
	TA1=F	F=Temperature A1.
	TA2=F	F=Temperature A2.
	TA3=F	F=Temperature A3.
	CCalDate=S	S=Conductivity calibration date.
	CG=F	F=Conductivity G.
	CH=F	F=Conductivity H.
	CI=F	F=Conductivity I.
	CJ=F	F=Conductivity J.
	WBOTC=F	F=Conductivity wbotc.
	CTCor=F	F=Conductivity ctcor.
	CPCor=F	F=Conductivity cpcor.
	PCalDate=S	S=Pressure calibration date.
	PA0=F	F=Pressure A0.
	PA1=F	F=Pressure A1.
	PA2=F	F=Pressure A2.
	PTCA0=F	F=Pressure ptca0
	PTCA1=F	F=Pressure ptca1.
	PTCA2=F	F=Pressure ptca2.
	PTCB0=F	F=Pressure ptcb0.
	PTCB1=F	F=Pressure ptcb1.
	PTCB2=F	F=Pressure ptcb2.
PTempA0=F	F=Pressure temperature a0.	
PTempA1=F	F=Pressure temperature a1.	
PTempA2=F	F=Pressure temperature a2.	
POffset=F	F=Pressure offset (decibars).	

Note:
Use Seaterm232's Upload menu to upload data that will be processed by SBE Data Processing. Manually entering a data upload command does not produce data with the required header information for processing by SBE Data Processing.

Appendix IV: AF24173 Anti-Foulant Device

AF24173 Anti-Foulant Devices supplied for user replacement are supplied in polyethylene bags displaying the following label:

AF24173 ANTI-FOULANT DEVICE

FOR USE ONLY IN SEA-BIRD ELECTRONICS' CONDUCTIVITY SENSORS TO CONTROL THE GROWTH OF AQUATIC ORGANISMS WITHIN ELECTRONIC CONDUCTIVITY SENSORS.

ACTIVE INGREDIENT:

Bis(tributyltin) oxide.....	53.0%
OTHER INGREDIENTS:	<u>47.0%</u>
Total.....	100.0%

DANGER

See the complete label within the Conductivity Instrument Manual for Additional Precautionary Statements and Information on the Handling, Storage, and Disposal of this Product.

Net Contents: Two anti-foulant devices
Sea-Bird Electronics, Inc.
13431 NE 20th Street
Bellevue, WA 98005

EPA Registration No. 74489-1
EPA Establishment No. 74489-WA-1

AF24173 Anti-Foulant Device

FOR USE ONLY IN SEA-BIRD ELECTRONICS' CONDUCTIVITY SENSORS TO CONTROL THE GROWTH OF AQUATIC ORGANISMS WITHIN ELECTRONIC CONDUCTIVITY SENSORS.

ACTIVE INGREDIENT:

Bis(tributyltin) oxide.....	53.0%
OTHER INGREDIENTS:	47.0%
Total.....	100.0%

DANGER

See Precautionary Statements for additional information.

FIRST AID	
If on skin or clothing	<ul style="list-style-type: none"> • Take off contaminated clothing. • Rinse skin immediately with plenty of water for 15-20 minutes. • Call a poison control center or doctor for treatment advice.
If swallowed	<ul style="list-style-type: none"> • Call poison control center or doctor immediately for treatment advice. • Have person drink several glasses of water. • Do not induce vomiting. • Do not give anything by mouth to an unconscious person.
If in eyes	<ul style="list-style-type: none"> • Hold eye open and rinse slowly and gently with water for 15-20 minutes. • Remove contact lenses, if present, after the first 5 minutes, then continue rinsing eye. • Call a poison control center or doctor for treatment advice.
HOT LINE NUMBER	
Note to Physician	Probable mucosal damage may contraindicate the use of gastric lavage.
Have the product container or label with you when calling a poison control center or doctor, or going for treatment. For further information call National Pesticide Telecommunications Network (NPTN) at 1-800-858-7378.	

Net Contents: Two anti-foulant devices

Sea-Bird Electronics, Inc.
 13431 NE 20th Street
 Bellevue, WA 98005

EPA Registration No. 74489-1
 EPA Establishment No. 74489-WA-1

PRECAUTIONARY STATEMENTS

HAZARD TO HUMANS AND DOMESTIC ANIMALS

DANGER

Corrosive - Causes irreversible eye damage and skin burns. Harmful if swallowed. Harmful if absorbed through the skin or inhaled. Prolonged or frequently repeated contact may cause allergic reactions in some individuals. Wash thoroughly with soap and water after handling.

PERSONAL PROTECTIVE EQUIPMENT

USER SAFETY RECOMMENDATIONS

Users should:

- Remove clothing immediately if pesticide gets inside. Then wash thoroughly and put on clean clothing.
- Wear protective gloves (rubber or latex), goggles or other eye protection, and clothing to minimize contact.
- Follow manufacturer's instructions for cleaning and maintaining PPE. If no such instructions for washables, use detergent and hot water. Keep and wash PPE separately from other laundry.
- Wash hands with soap and water before eating, drinking, chewing gum, using tobacco or using the toilet.

ENVIRONMENTAL HAZARDS

Do not discharge effluent containing this product into lakes, streams, ponds, estuaries, oceans, or other waters unless in accordance with the requirements of a National Pollutant Discharge Elimination System (NPDES) permit and the permitting authority has been notified in writing prior to discharge. Do not discharge effluent containing this product to sewer systems without previously notifying the local sewage treatment plant authority. For guidance contact your State Water Board or Regional Office of EPA. This material is toxic to fish. Do not contaminate water when cleaning equipment or disposing of equipment washwaters.

PHYSICAL OR CHEMICAL HAZARDS

Do not use or store near heat or open flame. Avoid contact with acids and oxidizers.

DIRECTIONS FOR USE

It is a violation of Federal Law to use this product in a manner inconsistent with its labeling. For use only in Sea-Bird Electronics' conductivity sensors. Read installation instructions in the applicable Conductivity Instrument Manual.

STORAGE AND DISPOSAL

PESTICIDE STORAGE: Store in original container in a cool, dry place. Prevent exposure to heat or flame. Do not store near acids or oxidizers. Keep container tightly closed.

PESTICIDE SPILL PROCEDURE: In case of a spill, absorb spills with absorbent material. Put saturated absorbent material to a labeled container for treatment or disposal.

PESTICIDE DISPOSAL: Pesticide that cannot be used according to label instructions must be disposed of according to Federal or approved State procedures under Subtitle C of the Resource Conservation and Recovery Act.

CONTAINER HANDLING: Nonrefillable container. Do not reuse this container for any other purpose. Offer for recycling, if available.

Appendix V: Replacement Parts

Part Number	Part	Application Description	Quantity in MicroCAT
50441	AA Saft Lithium cell set (12)	Power MicroCAT	1
801863	Cell holder for MicroCATs with firmware version 4.0 and later	Holds AA cells. Note: This cell holder has a yellow cover plate. Older MicroCATs use a cell holder with a red cover plate; those packs are wired differently, and will not work properly in this MicroCAT.	1
801542	AF24173 Anti-Foulant Device	Bis(tributyltin) oxide device inserted into anti-foulant device cup	1 (set of 2)
30411	Triton X-100	Octyl Phenol Ethoxylate – Reagent grade non-ionic cleaning solution for conductivity cell (supplied in 100% strength; dilute as directed)	1
801385	4-pin RMG-4FS to 9-pin DB-9S I/O cable with power leads, 2.4 m (8 ft)	From MicroCAT to computer	1
17043	Locking sleeve (for RMG)	Locks cable/plug in place	1
17046.1	4-pin RMG-4FS dummy plug with locking sleeve	For when cable not used	1
801206	4-pin MCIL-4FS (wet-pluggable connector) to 9-pin DB-9S I/O cable with power leads, 2.4 m (8 ft) long	From MicroCAT to computer	1
171192	Locking sleeve (wet-pluggable connector)	Locks cable/plug in place	1
171398.1	4-pin MDCD-4-F dummy plug with locking sleeve, wet-pluggable connector	For when cable not used	1
171888	25-pin DB-25S to 9-pin DB-9P cable adapter	For use with computer with DB-25 connector	-

Continued on next page

Continued from previous page

Part Number	Part	Application Description	Quantity in MicroCAT
60056	Spare hardware / O-ring kit for 37-SMP	Assorted hardware and O-rings: <ul style="list-style-type: none"> • 30900 Bolt, 1/4-20 x 2", Hex head, titanium (secures guide to connector end cap and clamp to sensor end cap) • 30633 Washer, 1/4" Split Ring Lock, titanium (for 30900) • 30634 Washer, 1/4" Flat, titanium (for 30900) • 31019 O-ring, Parker 2-008 N674-70 (for 30900) • 31066 Cap screw, 8-32 x 3/4 socket head, titanium (secures guide to connector end cap) • 31873 Cap Screw, 6-32 x 1/2", socket head, titanium (secures clamp to sensor end cap) • 30867 Washer, #6 split ring lock, titanium (for 31873) • 31755 Cap Screw, 8-32 x 1/4" SH, titanium (secures connector end cap to housing) • 30857 O-ring, Parker 2-033E15-80 (connector end cap O-rings) • 30858 O-ring, Parker 2-133 N674-70 (battery pack end cap O-ring) • 31322 O-ring, Parker 2-130 N674-70 (battery pack housing O-rings) • 31749 Hex Key, 7/64" long arm, DoALL BDH12106 (tool for battery pack) • 31089 Screw, 10-32 x 1/2" FH Phillips, titanium (secures cell guard to end cap) • 31118 Screw, 10-32 x 3/8" FH Phillips, titanium (secures cell guard to sensor end cap) • 31516 Hex Key, 9/64" long arm, DoALL AHT58010 (tool for guide) • 311281 Removable shipping sticker (covers cell intake and exhaust for storage) • Air bleed valve wire kit (for clearing bleed valve) 	-

Appendix VI: Manual Revision History

Manual Version	Date	Description
001	04/03	<ul style="list-style-type: none"> Initial release.
002	04/04	<ul style="list-style-type: none"> Firmware 2.4: Add averaging command. Firmware 2.5: Add commands for outputting salinity and sound velocity. Add description of flow path u-shape and necessary orientation. Update external power specification to 12-24 instead of 9-24 VDC, to prevent draining batteries. Add information on total cable resistance and on transient current needed for pump turn-on, for optional external power. Reference P line appears in DS reply only if no P sensor installed. Add more information about limitations on shipping lithium batteries.
003	06/04	<ul style="list-style-type: none"> Firmware 2.6: new board layout, new power specifications. Update power consumption / cable length calculations. Add updated information on shipping restrictions for lithium batteries
004	05/05	<ul style="list-style-type: none"> Add 600 m Druck pressure sensor. Update cleaning recommendations to correspond to revised application note 2D. Update AF24173 Anti-Foulant Device appendix to current label. Add troubleshooting section. Update battery shipping precautions. Add details on how to process MicroCAT data in SBE Data Processing's Derive module. Add caution about not running pump dry.
005	05/06	<ul style="list-style-type: none"> Update wet-pluggable connector information. Add more information to Recovery Warning.
006	12/06	<ul style="list-style-type: none"> Incorporate new bleed hole, change orientation recommendation. Add option for plastic housing. Add more explanation of NAvg=. Update pressure port maintenance – SBE no longer putting silicon oil in port.
007	06/07	<ul style="list-style-type: none"> Add handling precautions for plastic housing.
008	04/08	<ul style="list-style-type: none"> Update for Version 3 firmware changes: many commands changed, power specifications changed, pump operation changed. Add deployment recommendation that 37-SMP should be inclined ≥ 10 degrees from horizontal. Change stability specification for pressure to per year instead of per month. Update connector maintenance information for consistency with application note 57. Add information that POffset is in decibars.
009	07/08	<ul style="list-style-type: none"> Firmware revision 3.0c: <ul style="list-style-type: none"> - if no P sensor is installed, reference pressure now appears in GetCD instead of GetCC, and appears in DS instead of DC. - Minimum conductivity frequency line removed from GetCD response if PumpInstalled=n. - SetPCBSerialNum1=, etc. removed. Update battery installation procedure, specifications, endurance, and shipping instructions for new battery packs (12 AA lithium cells). Add information that pump runs for polled sampling, regardless of minimum conductivity frequency. Correct cable length and external power example.
010	08/08	<ul style="list-style-type: none"> Firmware revision 3.0f: <ul style="list-style-type: none"> - Add new output format to match format available from firmware < 3.0. DDb,e now uploads data in this new format. - If StartLater>90 days in future, does StartNow. Manufacturing change: for plastic housing, 2 phillips-head screws at connector end cap end and 1 at sensor end cap end are replaced with hex screws. 9/64" allen wrench shipped with instrument.
011	01/09	<ul style="list-style-type: none"> Update for SeatermV2 terminal program. Add information about compatibility with Vista. Correction: Add PTempA0=, PTempA1=, PTempA2= to calibration coefficient commands.

Continued on next page

Continued from previous page

012	01/10	<ul style="list-style-type: none"> • Add information about Deployment Endurance Calculator. • Change Seasoft-Win32 to Seasoft V2, update file name to SeasoftV2_date.exe. • SBE Data Processing 7.20a: Add information about .xmlcon file. • Add CE mark. • Update SBE address. • Update anti-foul label in Appendix with new Container Handling requirement and new address.
013	07/10	<ul style="list-style-type: none"> • Firmware 3.0j: Fixed bug related to StartDateTime=. Previously, when StartLater was sent, register ignored month in StartDateTime=, and started at the next day and time corresponding to the day and time (example: if it is July 1 and you set it to start on August 15, it ignored the August part of the date, and started on July 15). Documentation said could be started 90 days out, but this actually limited it to 30 days out. Now, it provides a message saying it will start logging in 5 seconds if the start date is more than 30 days out. • Add 60053 spares kit for plastic housing.
014	10/10	<ul style="list-style-type: none"> • Update for changes to SeatermV2 version 1.1 (upload now converts .xml file to .hex and .xmlcon files, which are used in Data Conversion to convert to .cnv file for further processing). • Remove references to Druck pressure sensors (pressure sensors can be supplied by other manufacturers).
015	03/11	<ul style="list-style-type: none"> • SeatermV2 1.1b changes: <ul style="list-style-type: none"> - Update upload procedure, Seaterm232 now automatically starts SBE Data Processing after upload - Update SeatermV2 Instruments list screen capture • Add information about compatibility with Windows 7
016	04/11	<ul style="list-style-type: none"> • Firmware Version 4.0 MicroCAT, new electronics, new mechanical configuration, new high-efficiency pump, new battery pack.
017	08/12	<ul style="list-style-type: none"> • Update Shipping Precautions for latest IATA rules. • Add Declaration of Conformity. • Add cable and wiring diagrams. • Add more information on selecting output variables for data processing of uploaded data. • Triton – update company name (Avantor Performance Materials) and link. • Remove factory-set commands: SetPressureInstalled=, SetMfgDate=, SetPCBAssembly=, SetPCBSerialNum=. • Glossary - Add information on ODO MicroCATs • Sampling Mode examples -- Add setting date/time to all examples, and add setting output format to sync mode example. • Update configuration dialog box in SBE Data Processing. • Add weights for titanium version to specifications. • Fix typos.
018	01/13	<ul style="list-style-type: none"> • Update lithium shipping restrictions to meet 2013 requirements. • Update Serial Port Configuration dialog box. • Update Upload dialog box. • Update software compatibility information. • Add information about limitations with 115200 baud rate. • Fix typos.
019	09/13	<ul style="list-style-type: none"> • Update plastic housing depth rating to 350 meters. • Update SeatermV2 screen capture and Upload dialog box. • Add information on editing raw .hex files. • Update photo in Calibration section. • Update contents of spare hardware & o-ring kit. • Add information on new protective label to cover intake and exhaust, in place of plugs that were used previously. • Update information on cleaning air bleed valve. • Clarify that accuracy specifications are ±. • Glossary - Add information on SDI-12 MicroCATs. • Update Declaration of Conformity. • Fix typos.

Continued on next page

Continued from previous page

020	03/14	<ul style="list-style-type: none">• Update temperature range and accuracy specifications.• Update lithium cell and battery language to conform to latest IATA rules.• Add information on O-ring maintenance.• Add caution on using spray can lubricants on MCBH connectors.• Remove <i>standard</i> and <i>optional</i> language.
-----	-------	---

Index

.hex files
editing · 58

A

Air bleed hole · 47, 60
Anti-Foulant Device · 76
 removal before shipping to Sea-Bird · 65
 replacing · 63, 64
Autonomous sampling · 27, 41

B

Battery pack · 11, 48
 description · 17
 endurance · 10
 endurance · 14
 endurance · 19
 installing · 17
 replacing · 62
 shipping precautions · 8
Baud rate · 29, 38
Bleed hole · 47, 60

C

Cable length · 29
Cables · 13
Calibration · 65
CE certification · 3
Cells
 description · 17
 installing · 17
 replacing · 62
Cleaning · 60
Clock · 11, 71
Command summary · 74
Commands
 autonomous sampling · 41
 baud rate · 38
 calibration coefficients · 44
 data format · 40
 data upload · 43, 51
 date and time · 38
 descriptions · 30
 general setup · 38
 logging · 41
 memory setup · 40
 polled sampling · 42
 pump setup · 39
 serial line sync · 42
 status · 31
 upload · 51
Communication defaults · 22
Conductivity cell · 71
 cleaning · 60
Conductivity sensor calibration · 65
Connector · 12, 59
Corrosion precautions · 59

D

Data Conversion · 54
Data format · 40, 45
Data processing · 10, 19, 51, 54
Data upload · 43, 51
Date and time · 38
Declaration of Conformity · 3
Deployment · 47
 installation · 49
 preparing for · 17
 setup · 48
Deployment Endurance Calculator · 10, 14, 19
Deployment orientation · 10, 12, 49
Derive · 54
Description · 9
Dimensions · 12

E

Editing data files · 58
Electronics disassembly/reassembly · 72
End cap · 59
End cap connector · 12
External power · *See* Power, external

F

Flooded MicroCAT · 50
Format
 data · 45
Functional description · 71

G

Glossary · 69
Guard
 removal · 63, 64

I

Initializing memory · 40

L

Limited liability statement · 2
Logging · 27, 41

M

Maintenance · 59
Manual revision history · 82
Memory · 11
Memory setup · 40
Modes · *See* Sampling modes
Mounting · 47

O

Orientation · 47
O-ring
 maintenance · 62
Output format · 40, 45

P

Parker Super O-Lube · 70
Parts
 replacement · 80
Plastic housing
 handling · 61
Plumbing
 maintenance · 60
Polled sampling · 42
Power
 endurance · 10, 19
 external · 11, 15
Pressure sensor · 71
 maintenance · 62
Pressure sensor calibration · 65
Processing data · 51
Pump · 10, 11, 12, 25, 41, 42, 47, 49
Pump setup commands · 39

Q

Quick start · 6

R

Real-time setup
 baud rate · 29
 cable length · 29
Recovery · 50
 uploading data · 51
Replacement parts · 80
Revision history · 82

S

Sample timing · 14
Sampling modes · 25
 autonomous · 27, 41
 logging · 41
 polled · 26, 42
 serial line sync · 28, 42
SBE Data Processing · 10, 19, 54
Sea Plot · 54
Seasoft · 10, 19
Seaterm232 · 10, 19, 20, 51
SeatermV2 · 10, 19, 20, 51
Sensors · 11
Serial line sync · 28, 42
Setup commands · 38
ShallowCAT
 handling · 61
Shipping precautions · 8
Software · 10, 19
Specifications · 11
Status commands · 31
Storage · 60
Super O-Lube · 70
System description · 9

T

Temperature sensor calibration · 65
Terminal program · 10, 19, 20, 51
Testing · 19
Thermistor · 71
Timeout description · 29
Transient current · 15
Triton · 70
Troubleshooting · 67

U

Unpacking MicroCAT · 7
Upload · 43
Uploading data · 51

V

Versions · 82

W

Wiring · 13, 19