

# SBE 37-SMP MicroCAT

*Conductivity and Temperature Recorder  
with RS-485 Interface and Integral Pump*



For most applications, deploy in orientation shown (connector end down) for proper operation

***Shown with standard titanium housing;  
optional ShallowCAT plastic housing available***

**Note: NEW ADDRESS**  
as of January 2010

## User's Manual

Sea-Bird Electronics, Inc.

13431 NE 20<sup>th</sup> Street

Bellevue, Washington 98005 USA

Telephone: +1 425-643-9866..... Manual version #015, 03/04/11

Fax: +1 425-643-9954

Firmware version 3.0h and later

E-mail: seabird@seabird.com

SeatermV2 version 1.1b and later

Website: www.seabird.com

SBE Data Processing version 7.21c and later



# Limited Liability Statement

Extreme care should be exercised when using or servicing this equipment. It should be used or serviced only by personnel with knowledge of and training in the use and maintenance of oceanographic electronic equipment.

SEA-BIRD ELECTRONICS, INC. disclaims all product liability risks arising from the use or servicing of this system. SEA-BIRD ELECTRONICS, INC. has no way of controlling the use of this equipment or of choosing the personnel to operate it, and therefore cannot take steps to comply with laws pertaining to product liability, including laws which impose a duty to warn the user of any dangers involved in operating this equipment. Therefore, acceptance of this system by the customer shall be conclusively deemed to include a covenant by the customer to defend, indemnify, and hold SEA-BIRD ELECTRONICS, INC. harmless from all product liability claims arising from the use or servicing of this system.

# Table of Contents

<b>Section 1: Introduction</b> .....	<b>5</b>
About this Manual .....	5
Quick Start .....	5
Unpacking MicroCAT .....	6
Shipping Precautions .....	7
<b>Section 2: Description of MicroCAT</b> .....	<b>8</b>
System Description .....	8
Specifications.....	10
Dimensions and End Cap Connector .....	11
Sample Timing.....	12
Battery Endurance.....	12
External Power.....	13
Cable Length and External Power .....	13
<b>Section 3: Preparing MicroCAT for Deployment</b> .....	<b>14</b>
Battery Installation.....	14
Software Installation .....	16
Power and Communications Test and Setting MicroCAT ID.....	16
Test Setup .....	16
Test and Setting ID .....	17
<b>Section 4: Deploying and Operating MicroCAT</b> .....	<b>22</b>
Operation Description.....	22
Sampling Modes .....	23
Polled Sampling.....	23
Autonomous Sampling (Logging commands) .....	24
Serial Line Synchronization (Serial Line Sync) .....	25
Real-Time Data Acquisition .....	26
Cable Termination .....	26
Timeout Description .....	27
Command Descriptions.....	27
Data Formats.....	43
Optimizing Data Quality / Deployment Orientation .....	46
Setup for Deployment.....	47
Deployment.....	48
Recovery .....	49
Uploading and Processing Data .....	50
<b>Section 5: Routine Maintenance and Calibration</b> .....	<b>57</b>
Corrosion Precautions.....	57
Connector Mating and Maintenance .....	57
Conductivity Cell Maintenance .....	58
Plumbing Maintenance .....	58
Handling Instructions for Plastic <i>ShallowCAT</i> Option .....	59
Replacing Batteries .....	60
Pressure Sensor (optional) Maintenance .....	60
Replacing Anti-Foulant Devices – Mechanical Design Change .....	61
Replacing Anti-Foulant Devices (SBE 37-SI, SM, IM).....	62
Sensor Calibration.....	63
<b>Section 6: Troubleshooting</b> .....	<b>65</b>
Problem 1: Unable to Communicate with MicroCAT .....	65
Problem 2: No Data Recorded .....	65
Problem 3: Unreasonable T, C, or P Data.....	65
Problem 4: Salinity Spikes.....	66

<b>Glossary .....</b>	<b>67</b>
<b>Appendix I: Functional Description.....</b>	<b>69</b>
Sensors .....	69
Sensor Interface .....	69
Real-Time Clock.....	69
<b>Appendix II: Electronics Disassembly/Reassembly .....</b>	<b>70</b>
<b>Appendix III: Command Summary .....</b>	<b>71</b>
<b>Appendix IV: AF24173 Anti-Foulant Device .....</b>	<b>74</b>
<b>Appendix V: Replacement Parts .....</b>	<b>78</b>
<b>Appendix VI: Manual Revision History .....</b>	<b>80</b>
<b>Index.....</b>	<b>82</b>

# Section 1: Introduction

This section includes a Quick Start procedure, photos of a standard MicroCAT shipment, and battery shipping precautions.

---

## About this Manual

This manual is to be used with the SBE 37-SMP MicroCAT Conductivity and Temperature Recorder (pressure optional) with RS-485 Serial interface, internal Memory, and integral Pump. It is organized to guide the user from installation through operation and data collection. We've included detailed specifications, command descriptions, maintenance and calibration information, and helpful notes throughout the manual.

Sea-Bird welcomes suggestions for new features and enhancements of our products and/or documentation. Please contact us with any comments or suggestions (seabird@seabird.com or 425-643-9866). Our business hours are Monday through Friday, 0800 to 1700 Pacific Standard Time (1600 to 0100 Universal Time) in winter and 0800 to 1700 Pacific Daylight Time (1500 to 0000 Universal Time) the rest of the year.

---

## Quick Start

Follow these steps to get a Quick Start using the MicroCAT. The manual provides step-by-step details for performing each task:

1. Install batteries and test power and communications (*Section 3: Preparing MicroCAT for Deployment*).
2. Deploy the MicroCAT (*Section 4: Deploying and Operating MicroCAT*):
  - A. Install new batteries if necessary.
  - B. Ensure all data has been uploaded, and then send **#iiInitLogging** to make entire memory available for recording if desired.
  - C. Set date and time.
  - D. Establish setup and logging parameters.
  - E. Check status (**#iiDS**) and calibration coefficients (**#iiDC**) to verify setup.
  - F. Set MicroCAT to start logging now or in the future.
  - G. Remove protective plugs from anti-foulant device cup, and verify AF24173 Anti-Foulant Devices are installed. Leave protective plugs off for deployment.
  - H. Install dummy plug or cable connector, and locking sleeve.
  - I. Deploy MicroCAT, using Sea-Bird or customer-supplied hardware. For **most** applications, mount the MicroCAT with the connector at the bottom for proper operation.

# Unpacking MicroCAT

Shown below is a typical MicroCAT shipment.



SBE 37-SMP MicroCAT



Batteries



I/O cable



Spare hardware and o-ring kit



Conductivity cell cleaning solution (Triton-X)



MicroCAT User Manual



Software, and Electronic Copies of Software Manuals and User Manual

### Shipping Precautions



Batteries packed in heat-sealed plastic (above). Sea-Bird then places batteries in bubble-wrap outer sleeve and strong packaging for shipment (below).



For its main power supply, the MicroCAT uses twelve 3.6-volt AA lithium batteries (Saft LS14500). The MicroCAT was shipped from the factory with the batteries packaged separately within the shipping box (not inside the MicroCAT). When packaged in the manner shown and described at left, the batteries are **not** considered Dangerous/Hazardous Goods, and may be shipped via commercial aircraft (those governed by DOT or IATA, including passenger airlines, or cargo carriers such as FedEx, DHL, UPS, etc.) if no more than the number of batteries required to operate the instrument are included in the shipment (i.e., no spares are included).



Assembled battery pack

**WARNING!**  
Do not ship assembled battery pack or spare lithium batteries by commercial aircraft.

#### IMPORTANT NOTE:

Do not ship the assembled battery pack or spare lithium batteries by commercial aircraft. Refer to *Lithium Battery Shipping Guidelines* for background information on the applicable regulations as well as Sea-Bird’s interpretation of those regulations, how they apply to the batteries in our equipment, and how we package and label our equipment.

Before attempting to communicate with the MicroCAT, the batteries must be installed following the instructions in *Section 3: Preparing MicroCAT for Deployment*.

**Note:**  
Remove the batteries before returning the MicroCAT to Sea-Bird. Do not return used batteries to Sea-Bird when shipping the MicroCAT for repair. All setup information is preserved in EEPROM when the batteries are removed.

If you will re-ship the MicroCAT by commercial aircraft after you have finished testing:

1. Remove the battery pack assembly from the MicroCAT.
2. Remove the batteries from the battery pack assembly.
3. Pack the batteries separately as described in *Lithium Battery Shipping Guidelines*.

# Section 2: Description of MicroCAT

This section describes the functions and features of the SBE 37-SMP MicroCAT, including specifications, dimensions, end cap connector, sample timing, battery endurance, and external power.

## System Description

Standard titanium housing



Optional plastic *ShallowCAT* housing



For most applications, deploy in orientation shown (connector end down) for proper operation – see *Optimizing Data Quality / Deployment Orientation in Section 4: Deploying and Operating MicroCAT*

The SBE 37-SMP MicroCAT is a high-accuracy conductivity and temperature recorder (pressure optional) with internal battery and non-volatile memory, an integral pump, and an optional **RS-485 serial interface**. Designed for moorings and other long-duration, fixed-site deployments, MicroCATs have non-corroding titanium housings rated for operation to 7000 meters (23,000 feet) or pressure sensor full-scale range. An optional plastic *ShallowCAT* housing rated for 250 meters (820 feet) is also available.

Communication with the MicroCAT is over a 2-wire, RS-485 link. Commands can be sent to the MicroCAT to provide status display, data acquisition setup, data retrieval, and diagnostic tests. User-selectable operating modes include:

- **Autonomous sampling** – At pre-programmed intervals, the MicroCAT wakes up, runs the pump, samples, stores data in its FLASH memory, and goes to sleep.
- **Polled sampling** – On command, the MicroCAT wakes up, runs the pump, takes one sample, transmits the data, and goes to sleep. Polled sampling is useful for integrating the MicroCAT with satellite, radio, or wire telemetry equipment.
- **Serial line sync** – In response to a pulse on the serial line, the MicroCAT wakes up, runs the pump, samples, stores the data in its FLASH memory, optionally transmits the data, and goes to sleep. This provides an easy method for synchronizing MicroCAT sampling with other instruments such as Acoustic Doppler Current Profilers (ADCPs) or current meters, without drawing on their battery or memory resources.

A command to take a sample can be sent globally to all MicroCATs on the RS-485 line. Each MicroCAT then holds the data in a buffer until it receives a command to transmit the data.

The MicroCAT can be deployed in two ways:

- **Cable installed** – The MicroCAT can be remotely controlled, allowing for polled sampling or serial line sync, or for transmission of occasional samples while autonomous sampling. If desired, data can be periodically uploaded while the MicroCAT remains deployed.
- **Dummy plug installed** – The MicroCAT cannot be remotely controlled. Autonomous sampling is programmed before deployment, and data is uploaded after recovery.



Calibration coefficients stored in EEPROM allow the MicroCAT to transmit data in engineering units. The MicroCAT retains the temperature and conductivity sensors used in the SEACAT and SEACAT *plus* family. The MicroCAT's aged and pressure-protected thermistor has a long history of exceptional accuracy and stability (typical drift is less than 0.002 °C per year). Electrical isolation of the conductivity electronics eliminates any possibility of ground-loop noise.

The MicroCAT's internal-field conductivity cell is immune to proximity errors and unaffected by external fouling. A plastic cup with threaded covers at the conductivity cell intake and pump exhaust retains the expendable AF24173 Anti-Foulant Devices.

The MicroCAT's integral pump runs for 1.0 second each time the MicroCAT takes a sample, providing the following advantages over a non-pumped system:

- Improved conductivity response – The pump flushes the previously sampled water from the conductivity cell and brings a new water sample quickly into the cell.
- Reduced fouling – Water does not freely flow through the conductivity cell between samples, minimizing fouling.

**Note that the MicroCAT was designed to be deployed as shown, with the intake/exhaust in an inverted U-shape.** This orientation prevents sediment from being trapped in the pump impeller housing. An air bleed hole in the top of the duct allows air to escape from the plumbing, so the pump will prime. See *Optimizing Data Quality / Deployment Orientation* in *Section 4: Deploying and Operating MicroCAT*.

The MicroCAT's optional strain-gauge pressure sensor is available in the following pressure ranges: 20, 100, 350, 600, 1000, 2000, 3500, and 7000 meters. Compensation of the temperature influence on pressure offset and scale is performed by the MicroCAT's CPU.

Future upgrades and enhancements to the MicroCAT firmware can be easily installed in the field through a computer RS-485 serial port and the bulkhead connector on the MicroCAT, without the need to return the MicroCAT to Sea-Bird.



Shown with conductivity cell guard removed

#### Notes:

- Help files provide detailed information on the use of SeatermV2, Seaterm485, and SBE Data Processing.
- A separate software manual on CD-ROM contains detailed information on the setup and use of SBE Data Processing.
- Sea-Bird supplies the current version of our software when you purchase an instrument. As software revisions occur, we post the revised software on our FTP site. See our website ([www.seabird.com](http://www.seabird.com)) for the latest software version number, a description of the software changes, and instructions for downloading the software from the FTP site.

The MicroCAT is supplied with a powerful software package, SEASOFT® V2, which includes:

- **SeatermV2** – terminal program for easy communication and data retrieval. SeatermV2 is a *launcher*, and launches the appropriate terminal program for the selected instrument (**Seaterm485** for RS-485 instruments such as this MicroCAT).
- **SBE Data Processing** - program for calculation and plotting of conductivity, temperature, pressure (optional), and derived variables such as salinity, sound velocity, depth, density, etc.

## Specifications

**Note:**

Pressure ranges are expressed in meters of deployment depth capability.

	Temperature (°C)	Conductivity (S/m)	Optional Pressure
<b>Measurement Range</b>	-5 to +35	0 to 7 (0 to 70 mS/cm)	0 to full scale range: 20 / 100 / 350 / 600 / 1000 / 2000 / 3500 / 7000 meters
<b>Initial Accuracy</b>	0.002	0.0003 (0.003 mS/cm)	0.1% of full scale range
<b>Typical Stability</b>	0.0002 per month	0.0003 (0.003 mS/cm) per month	0.05% of full scale range per year
<b>Resolution</b>	0.0001	0.00001 (0.0001 mS/cm)	0.002% of full scale range
<b>Sensor Calibration</b>	+1 to +32	0 to 6; physical calibration over range 2.6 to 6 S/m, plus zero conductivity (air)	Ambient pressure to full scale range in 5 steps
<b>Memory</b>	8 Mbyte non-volatile FLASH memory		
<b>Data Storage</b>	Conductivity & temperature: 6 bytes/sample (3 bytes each) Time: 4 bytes/sample. Pressure (optional): 5 bytes/sample.		
	<b>Recorded Parameters</b>	<b>Memory Space (number of samples)</b>	
	C, T, and time	800,000	
	C, T, P, and time	533,000	
<b>Real-Time Clock</b>	32,768 Hz TCXO accurate to ±1 minute/year.		
<b>Internal Batteries</b>	Nominal 10.6 Amp-hour pack consisting of 12 AA Saft LS 14500 lithium batteries (3.6 V and 2.45 Amp-hours each). Capacity for more than 89,000 samples for a typical sampling scheme (see <i>Battery Endurance</i> for example calculation). See <i>Shipping Precautions</i> in <i>Section 1: Introduction</i> . Note: Saft batteries can be purchased from Sea-Bird or other sources. See Saft's website for suppliers ( <a href="http://www.saftbatteries.com">www.saftbatteries.com</a> ). Alternatively, substitute either of the following: - Tadiran TL-4903, AA (3.6 V and 2.4 Amp-hours each) ( <a href="http://www.tadiran.com">www.tadiran.com</a> ) - Electrochem 3B0064/BCX85, AA (3.9 V and 2.0 Amp-hours each) ( <a href="http://www.electrochemsolutions.com">www.electrochemsolutions.com</a> )		
<b>External Input Power</b>	0.5 Amps at 9-24 VDC. To avoid draining internal batteries, use an external voltage greater than 10 VDC. See <i>External Power</i> .		
<b>Power Requirements</b>	<ul style="list-style-type: none"> <li>• Quiescent current: 30 microAmps.</li> <li>• Communication current: 0.15 milliAmps.</li> <li>• Acquisition current: <ul style="list-style-type: none"> <li>- 15 milliAmps if transmitting real-time data.</li> <li>- 13 milliAmps if not transmitting real-time data (no real-time data for autonomous sampling; real-time data is optional for serial line sync mode).</li> </ul> </li> <li>• Pump current: 260 milliAmps (0.26 Amp-second for 1.0 second pulse)</li> </ul> Acquisition time: 1.8 – 2.6 seconds/sample (depends on sampling mode and inclusion of pressure sensor, see <i>Sample Timing</i> ).		
<b>Housing and Depth Rating</b>	<i>Standard:</i> Titanium housing rated at 7000 m (23,000 ft) <i>Optional:</i> Plastic housing rated at 250 m (820 ft)		
<b>Weight (without pressure sensor)</b>	<i>Standard titanium housing:</i> In air: 5 kg (11 lbs)                      In water: 3 kg (7 lbs) <i>Optional plastic housing:</i> In air: 3.5 kg (7.7 lbs)                      In water: 1.5 kg (3.3 lbs)		

**CAUTION:**

See *Section 5: Routine Maintenance and Calibration* for handling instructions for the plastic *ShallowCAT* housing.

### Dimensions and End Cap Connector

**Notes:**

- Dimensions in millimeters (inches).
- For most applications, deploy in the orientation shown (connector end down) for proper operation.

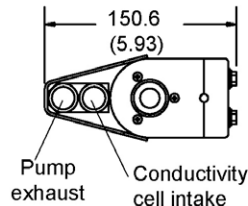
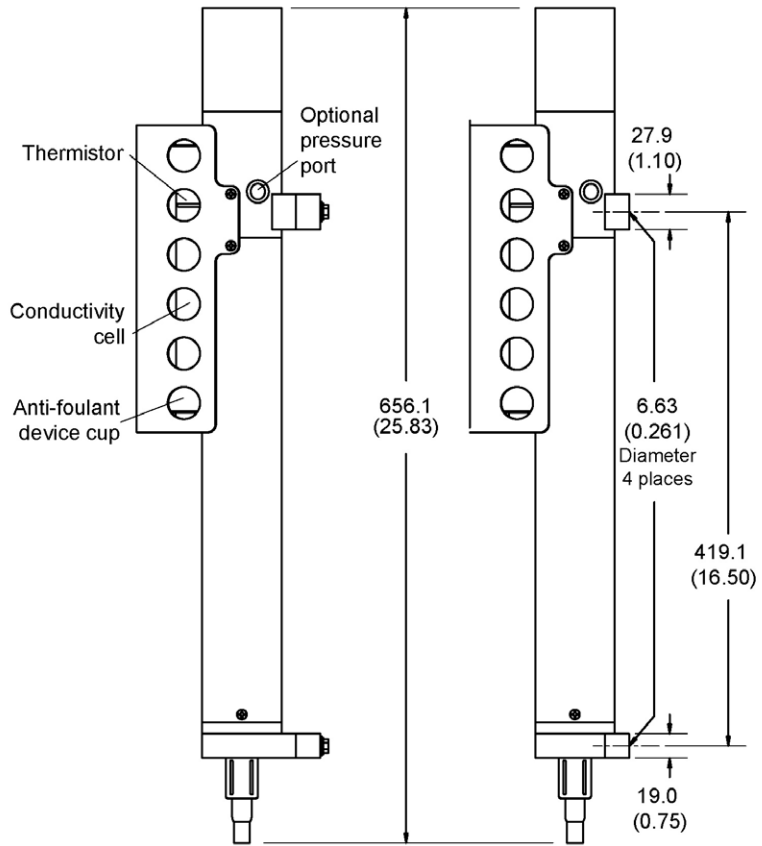
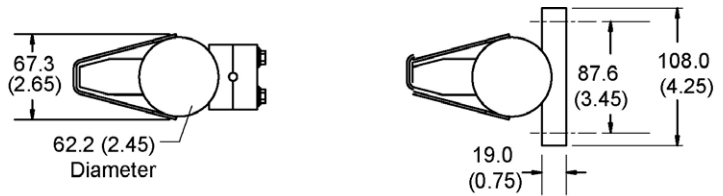

**Standard Wire Mounting Clamp and Guide**

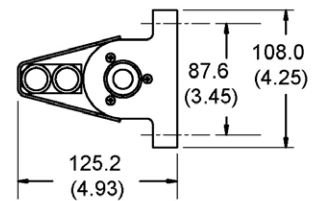

**Alternate Flat Surface Mounting Brackets**

○ = standard XSG-4-BCL-HP-SS connector  
 ○ = optional MCBH-4MP (WB), TI (3/8" length base, 1/2-20 thread) connector

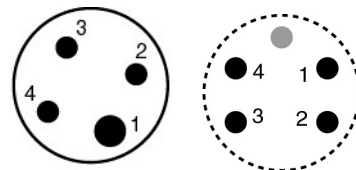

Pin	Signal
1	Common
2	RS-485 A
3	RS-485 B
4	External power (9-24 VDC)

## Sample Timing

### Notes:

- The pump runs for 1.0 second before each sample measurement.
- Acquisition time shown does not include time to transmit real-time data, which is dependent on baud rate and number of characters being transmitted (defined by **#iiOutputFormat=**, **#iiOutputSal=**, **#iiOutputSV=**, **#iiOutputDensity**, and **#iiOutputDepth=**).
- Time stored and output with data is the time at the **start** of the sample, after a small amount of time for the MicroCAT to wake up, run the pump, and prepare to sample. For example, if the MicroCAT is programmed to wake up and sample at 12:00:00, the stored time will indicate 12:00:01 or 12:00:02.

Sample timing is dependent on several factors, including sampling mode and whether the MicroCAT has an optional pressure sensor. The pump runs for 1.0 second while the Wein bridge is stabilizing before each measurement.

### Autonomous Sampling (time between samples = **#iiSampleInterval**)

Power on time for each sample while logging:

- **Without pressure:** power-on time = 1.8 seconds to run pump and sample
- **With pressure:** power-on time = 2.4 seconds to run pump and sample

### Polled Sampling, Serial Line Sync Sampling, or GData

Time from receipt of take sample command to beginning of reply:

- **Without pressure:** power-on time = 2.0 seconds to run pump and sample
- **With pressure:** power-on time = 2.6 seconds to run pump and sample

**Communications Timing**, which is the time to request and transmit data from each MicroCAT to the computer/controller (**Dataii** command): 0.5 seconds

## Battery Endurance

### Notes:

- If the MicroCAT is logging data and the battery voltage is less than 6.15 volts for 5 consecutive scans, the MicroCAT halts logging.
- Sea-Bird recommends using the capacity value of 8.8 Amp-hours for the Saft batteries as well as for the alternate battery types (Tadiran TL-4903 and Electrochem 3B0064/BCX85 AA).
- **See Specifications above for data storage limitations.**

The battery pack has a nominal capacity of 10.6 Amp-hours. This is lower than the Saft factory capacity rating (2.45 Amp-hours \* 6 = 14.7 Amp-hours), because the battery holder includes voltage up-conversion circuitry that consumes some battery capacity. For planning purposes, to account for the MicroCAT's current consumption patterns and for environmental conditions affecting battery performance, **Sea-Bird recommends using a conservative value of 8.8 Amp-hours.**

Current consumption is as follows:

- Acquisition time is shown above in *Sample Timing*. Acquisition current varies, depending on whether the MicroCAT is transmitting real-time data: 15 mA if transmitting real-time data, 13 mA if not.
- Pump current is 0.26 Amp-seconds per sample (1.0 second pulse).
- Communications current is 0.15 mA. Assuming the fastest practical interrogation scheme (wake all MicroCATs on mooring, send **GData**, send **Dataii** to each MicroCAT, and power off all MicroCATs), the communications current is drawn for approximately 0.5 seconds **per MicroCAT on the RS-485 line**. Each MicroCAT on the line draws this current while any of the MicroCATs are being queried to transmit data. Other interrogation schemes require more time.
- Quiescent current is 30 microAmps (0.26 AH per year).

So, battery endurance is highly dependent on the user-programmed sampling and query scheme. An example is shown below for one scheme.

*Example* - 10 MicroCATs with pressure sensor are set up to sample autonomously every 10 minutes (6 samples/hour), and a real-time sample will be requested by the computer every hour (**GData** and **Dataii**). How long can they be deployed?

**Autonomous Sampling** time (with pressure sensor) = 2.4 seconds

Sampling current consumption = 0.013 Amps \* 2.4 seconds = 0.031 Amp-seconds/sample

In 1 hour, sampling current = 6 \* 0.031 Amp-seconds/sample = **0.19 Amp-seconds/hour**

**Polled Sampling** time (with pressure sensor) = 2.6 seconds

In 1 hour, taking 1 sample with **GData** = 0.015 Amps \* 2.6 seconds = **0.04 Amp-seconds/hour**

**Pump** current consumption = 0.26 Amp-seconds/sample

In 1 hour, pump current = (6 autonomous + 1 **GData** sample) \* 0.26 Amp-seconds/sample = 1.82 Amp-seconds/hour

**Communication** current consumption / query = 0.15 mA \* 0.5 seconds/MicroCAT to be queried \* 10 MicroCATs on line = **0.001 Amp-seconds / hour**

**Quiescent** current = 30 microAmps = 0.03 mA

In 1 hour, quiescent current  $\approx$  0.03 mA \* 3600 seconds/hour = **0.11 Amp-seconds/hour**

**Total** current consumption / hour = 0.19 + 1.82 + 0.001 + 0.11 = **2.12 Amp-seconds/hour**

Capacity = (8.8 Amp-hours \* 3600 seconds/hr) / (2.12 Amp-seconds/hour) = 14,900 hours = 622 days = 1.7 years

Number of samples = 14,900 hours \* 6 samples/hour = 89,400 samples

## External Power

The MicroCAT can be powered from an external source. The internal lithium pack is diode-OR'd with the external source, so power will be drawn from whichever voltage source is higher. The MicroCAT can also be operated from the external supply without having the lithium batteries installed. Electrical isolation of conductivity is retained in units powered externally, preventing ground loop noise contamination in the conductivity measurement.

### Note:

See *Real-Time Data Acquisition* in *Section 4: Deploying and Operating MicroCAT* for additional limitations on cable length if transmitting real-time data.

## Cable Length and External Power

When powering the MicroCAT externally, a consideration in determining maximum cable length is supplying enough power at the power source so that sufficient voltage is available to power the MicroCAT, after IR loss in the cable (*from the 0.5 Amp turn-on transient, two-way resistance*).

The power requirement varies, depending on whether *any* power is drawn from the batteries:

- Provide at least 10 volts, after IR loss, to prevent the MicroCAT from drawing **any** power from the batteries (if you do not want to draw down the batteries):  $V - IR \geq 10$  volts
- Provide at least 9 volts, after IR loss, if allowing the MicroCAT to draw down the batteries or if no batteries are installed:  $V - IR \geq 9$  volts

where I = MicroCAT turn-on transient (0.5 Amps; see *Specifications*).

### Note:

Common wire resistances:

Gauge	Resistance (ohms/foot)
12	0.0016
14	0.0025
16	0.0040
18	0.0064
19	0.0081
20	0.0107
22	0.0162
24	0.0257
26	0.0410
28	0.0653

*Example 1* – For 20 gauge wire, what is maximum distance to transmit power to MicroCAT if using 12 volt power source and deploying MicroCAT with no batteries?

$V - IR \geq 9$  volts     12 volts - (0.50 Amps) \* (0.0107 ohms/foot \* 2 \* cable length)  $\geq 9$  volts

3 volts  $\geq$  (0.50 Amps) \* (0.0107 ohms/foot \* 2 \* cable length)     Cable length  $\leq$  280 ft = 85 meters

Using a higher voltage power supply or a different wire gauge would increase allowable cable length.

*Example 2* – Same as above, but there are 4 MicroCATs powered from same power supply.

$V - IR \geq 9$  volts     12 volts - (0.50 Amps \* 4 MicroCATs) \* (0.0107 ohms/foot \* 2 \* cable length)  $\geq 9$  volts

3 volts  $\geq$  (0.50 Amps \* 4 MicroCATs) \* (0.0107 ohms/foot \* 2 \* cable length)

Cable length  $\leq$  70 ft = 21 meters (to MicroCAT *furthest* from power source)

# Section 3: Preparing MicroCAT for Deployment

This section describes the pre-check procedure for preparing the MicroCAT for deployment. Installation of the battery pack, installation of Sea-Bird software, and testing power and communications and setting the MicroCAT ID are discussed.

## Battery Installation

### **WARNING!**

Do not air-ship the MicroCAT with batteries installed. See *Shipping Precautions in Section 1: Introduction*.



### **CAUTION:**

See *Section 5: Routine Maintenance and Calibration* for handling instructions for the plastic *ShallowCAT* housing.

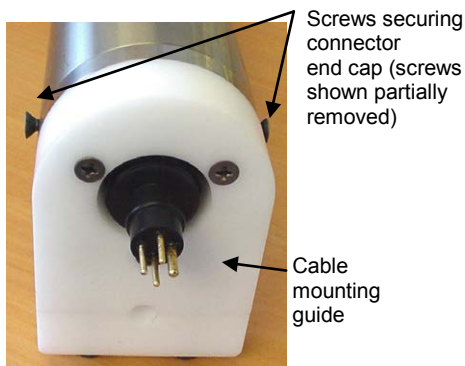

## Description of Batteries and Battery Pack

Sea-Bird supplies twelve 3.6-volt AA lithium batteries, shipped with the MicroCAT in a heat-sealed plastic bag placed in bubble wrap and a cardboard box. The empty battery holder is installed inside the MicroCAT for shipment.

No soldering is required when assembling the battery pack.

## Installing Batteries

1. Remove the I/O connector end cap:
  - A. Wipe the outside of the I/O end cap and housing dry, being careful to remove any water at the seam between them.
  - B. Remove the 2 flat Phillips-head titanium machine screws. Do not remove any other screws from the housing.  
Note: For plastic-housing MicroCATs shipped or retrofitted after July 2008, these are hex screws instead of Phillips-head screws. Sea-Bird ships the MicroCAT with a 9/64-inch Allen wrench for these screws.
  - C. Remove the I/O end cap by pulling firmly and steadily on the plastic cable mounting bracket. It may be necessary to twist or rock the end cap back and forth or use a non-marring tool on the edge of the cap to loosen it.
  - D. The end cap is electrically connected to the electronics with a Molex connector. Holding the wire cluster near the connector, pull gently to detach the female end of the connector from the pins.
  - E. Remove any water from the O-ring mating surfaces inside the housing with a lint-free cloth or tissue.
  - F. Put the end cap aside, being careful to protect the O-rings from damage or contamination.

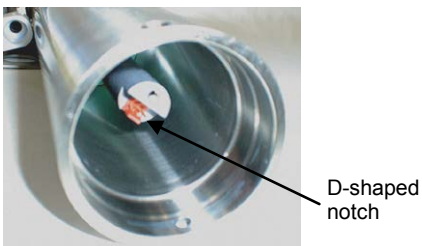
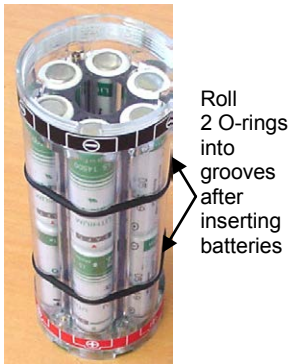
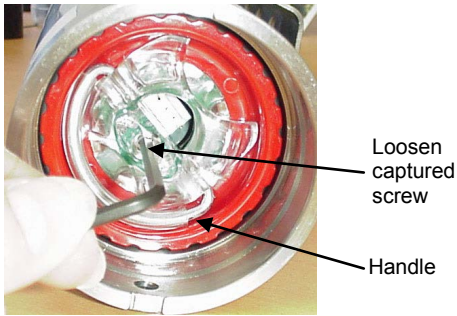

2. Remove the battery pack assembly from the housing:
    - A. Loosen the captured screw from the battery cover plate, using the 7/64-inch Allen wrench included with the shipment.
    - B. Lift the battery pack assembly straight out of the housing, using the handle.
  3. Keep the handle in an upright position. Holding the edge of the red\* cover plate, unscrew the cover plate from the battery pack assembly. (\*Note: Color may vary.)
  4. Roll the 2 O-rings on the outside of the battery pack out of their grooves.
  5. Insert each battery into the pack, **positive end (+) first**.
  6. Roll the 2 O-rings on the outside of the battery pack into place in the grooves. The O-rings compress the side of the battery pack and hold the batteries tightly in place in the pack.
  7. Re-install the battery pack cover plate:
    - A. Align the pin on the battery cover plate PCB with the post hole in the battery pack housing.
    - B. Place the handle in an upright position. Screw the red cover plate onto the battery pack assembly. Ensure the cover is tightly screwed on to provide a reliable electrical contact.
- 
8. Replace the battery pack assembly in the housing:
    - A. Align the D-shaped opening in the upper PCB with the D-shaped notch on the shaft. Lower the assembly slowly into the housing, and once aligned, push gently to mate the banana plugs on the battery compartment bulkhead with the lower PCB. A post at the bottom of the battery compartment mates with a hole in the battery pack's lower PCB to prevent improper alignment.
    - B. Secure the assembly to the shaft with the captured screw, using the 7/64-inch Allen wrench. Ensure the screw is tight to provide a reliable electrical contact.
  9. Re-install the I/O connector end cap:
    - A. Remove any water from the O-rings and mating surfaces in the housing with a lint-free cloth or tissue. Inspect the O-rings and mating surfaces for dirt, nicks, and cuts. Clean as necessary. Apply a light coat of O-ring lubricant (Parker Super O Lube) to the O-rings and mating surfaces.
    - B. Plug the female end of the Molex connector onto the pins, with the flat portion of the female end against the flat portion of the 'D' cutout. Verify the connector is properly aligned – a backward connection will prevent communication with the computer.
    - C. Carefully fit the end cap into the housing until the O-rings are fully seated.
    - D. Re-install the 2 flat Phillips-head titanium screws to secure the end cap.

## Software Installation

Sea-Bird recommends the following minimum system requirements for installing the software: Windows 2000 or later, 500 MHz processor, 256 MB RAM, and 90 MB free disk space for installation. Although SEASOFT V2 was designed to work with a PC running Win 2000/XP; extensive testing has not shown any compatibility problems when using the software with a PC running Windows Vista or Windows 7 (32-bit).

If not already installed, install Sea-Bird software programs on your computer using the supplied software CD:

1. Insert the CD in your CD drive.
2. Install software: Double click on **SeasoftV2\_date.exe** (*date* is the date that version of the software was created). Follow the dialog box directions to install the software. The installation program allows you to install the desired components. Install all the components, or just install SeatermV2 (terminal program *launcher* for the MicroCAT) and SBE Data Processing (data processing).

**Note:**

It is possible to use the MicroCAT without the SeatermV2 terminal program by sending direct commands from a dumb terminal or terminal emulator, such as Windows HyperTerminal.

The default location for the software is c:\Program Files\Sea-Bird. Within that folder is a sub-directory for each program.

---

## Power and Communications Test and Setting MicroCAT ID

The power and communications test will verify that the system works, prior to deployment.

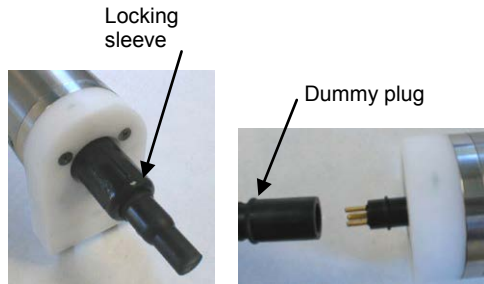

### Test Setup

1. Remove dummy plug (if applicable)
  - A. By hand, unscrew the locking sleeve from the MicroCAT's bulkhead connector. If you must use a wrench or pliers, be careful not to loosen the bulkhead connector instead of the locking sleeve.
  - B. Remove the dummy plug from the MicroCAT's I/O bulkhead connector by pulling the plug firmly away from the connector.
2. **Standard Connector** - Install the I/O cable connector, aligning the raised bump on the side of the connector with the large pin (pin 1 - ground) on the MicroCAT. **OR**  
**MCBH Connector** – Install the I/O cable connector, aligning the pins.
3. Connect the I/O cable connector to your computer's serial port.



### Test and Setting ID

**Note:**  
See SeatermV2's Help files.

1. Double click on **SeatermV2.exe**. The main screen looks like this:

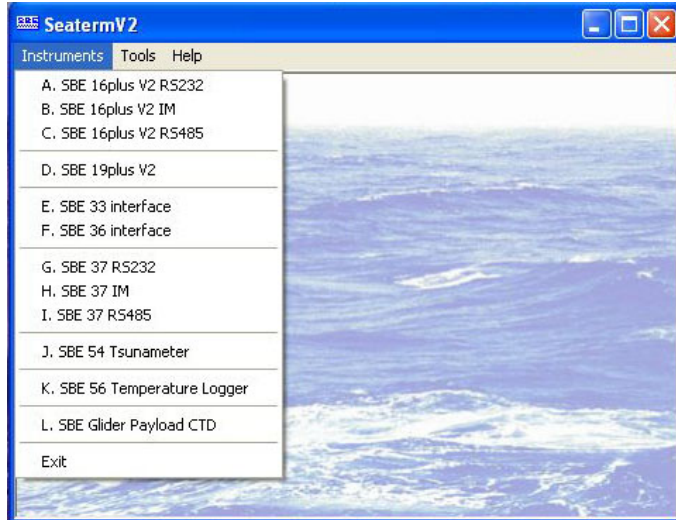

SeatermV2 is a *launcher*, and launches the appropriate terminal program for the selected instrument.

**Note:**  
See Seaterm485's Help files.

2. In the Instruments menu, select *SBE 37 RS485*. **Seaterm485** opens; the main screen looks like this:

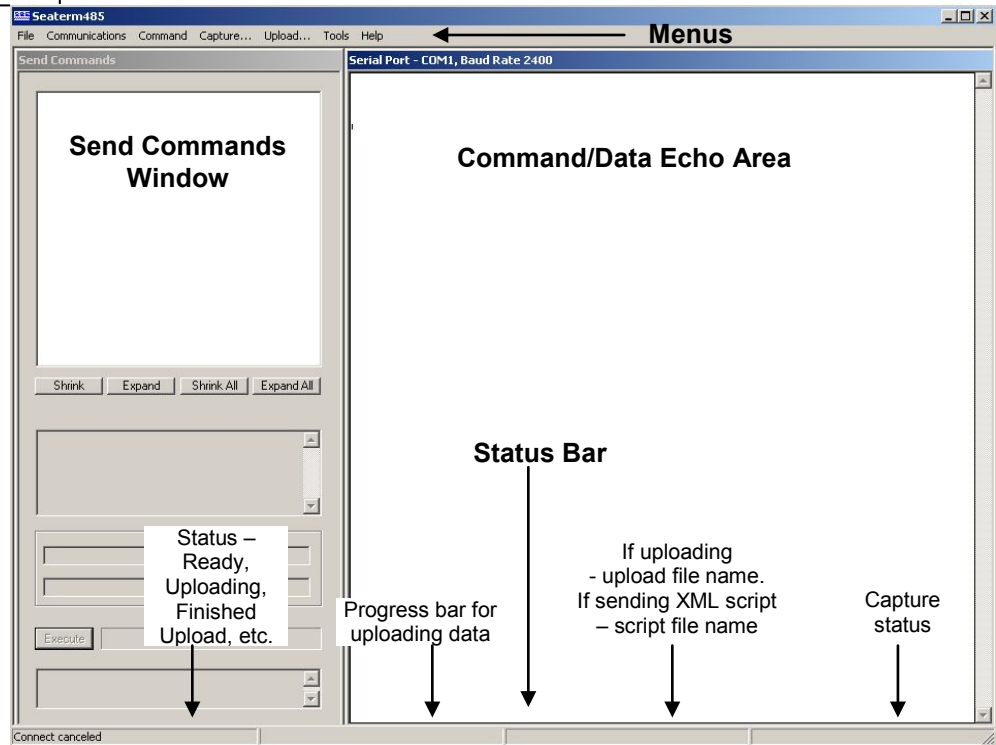

- **Menus** – For tasks and frequently executed instrument commands.
- **Send Commands window** – Contains commands applicable to your MicroCAT. The list appears after you connect to the MicroCAT.
- **Command/Data Echo Area** – Title bar of this window shows Seaterm485's current comm port and baud rate. Commands and the MicroCAT responses are echoed here. Additionally, a command can be manually typed or pasted (ctrl + V) here. Note that the MicroCAT must be *connected* and *awake* for it to respond to a command.
- **Status bar** – Provides connection, upload, script, and capture status information.

Following is a description of the menus:

Menu	Description	Equivalent Command*
File	<ul style="list-style-type: none"> <li>• Load command file – opens selected .XML command file, and fills Send Commands window with commands.</li> <li>• Unload command file – closes command file, and removes commands from Send Commands window.</li> <li>• Exit - Exit program.</li> </ul>	-
Communications	<ul style="list-style-type: none"> <li>• Configure – Establish communication parameters (comm port, baud rate, ID).</li> <li>• Connect – connect to comm port.</li> <li>• Disconnect – disconnect from comm port.</li> <li>• Disconnect and reconnect – may be useful if instrument has stopped responding.</li> </ul>	-
Command	<ul style="list-style-type: none"> <li>• Abort – interrupt and stop MicroCAT's attempt to connect or to upload data, or sending of a script.</li> <li>• Send 5 second break (for use with Serial Line Sync mode).</li> <li>• Send stop command.</li> <li>• Set local time– Set date and time to time sent by timekeeping software on your computer; accuracy <math>\pm 25</math> msec of time provided by computer.</li> <li>• Set UTC Time (Greenwich Mean Time) – Set date and time to time sent by timekeeping software on your computer; accuracy <math>\pm 25</math> msec of time provided by computer.</li> </ul>	<ul style="list-style-type: none"> <li>• (press Esc key several times for Abort)</li> <li>• <b>#iiStop</b></li> <li>• <b>#iiDateTime=</b></li> <li>• <b>#iiDateTime=</b></li> </ul>
Capture	Capture instrument responses on screen to file, to save real-time data or use for diagnostics. File has .cap extension. Click Capture menu again to turn off capture. Capture status displays in Status bar.	—
Upload	Upload data stored in memory, in a format that Sea-Bird's data processing software can use. Uploaded data has .xml extension, and is then automatically converted to a .hex and a .xmlcon file that can be used in SBE Data Processing's Data Conversion module. Before using Upload: <b>stop logging</b> by sending <b>#iiStop</b> .	Several status commands and appropriate data upload command as applicable to user selection of range of data to upload (use Upload menu if you will be processing data with SBE Data Processing)
Tools	<ul style="list-style-type: none"> <li>• Diagnostics log - Keep a diagnostics log.</li> <li>• Convert .XML data file – Using Upload menu automatically does this conversion; tool is available if there was a problem with the automatic conversion.</li> <li>• Send script – Send XML script to MicroCAT. May be useful if you have a number of MicroCATs to program with same setup.</li> </ul>	-

**Note:**

SeatermV2 with version < 1.1 did not convert the uploaded .xml data file to a .hex and .xmlcon file. Convert .XML data file in the Tools menu was used to convert the .xml data file to a .cnv file, which could be processed in SBE Data Processing. We recommend that you update your SeatermV2 software to 1.1b or later.

\*See *Command Descriptions* in Section 4: *Deploying and Operating MicroCAT*.

3. If this is the first time Seaterm485 is being used, the configuration dialog box displays:

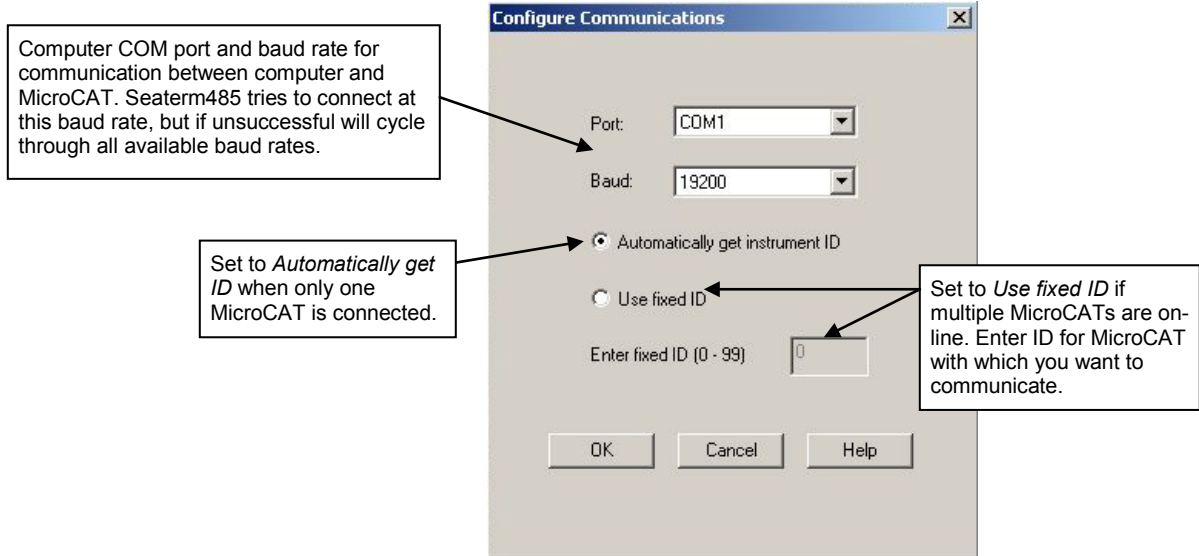

Make the desired selections, and click OK.

4. Seaterm485 tries to automatically connect to the MicroCAT. The connection attempt varies, depending on the configuration setting the last time Seaterm485 was used:

- If Seaterm485 was set to *Automatically get instrument ID* the last time it was used – Seaterm485 sends **id?** and waits for a response from the MicroCAT. Once the ID response is received, Seaterm485 sends **#iiGetHD**, using the ID provided by the MicroCAT.
- If Seaterm485 was set to *Use fixed ID* the last time it was used – Seaterm485 sends **#iiGetHD**, using the fixed ID that was entered the last time the software was used.

Seaterm485 then fills the Send Commands window with the correct list of commands for your MicroCAT.

**If there is no communication (no response to **id?** and/or no response to **#iiGetHD**):**

- A. In the Communications menu, select *Configure*. The Configure Communications dialog box appears. Select the Comm port and baud rate for communication. Note that the factory-set baud rate is documented on the Configuration Sheet. If using a fixed ID, verify that the designated ID is correct for the MicroCAT with which you want to communicate. Click OK.
- B. In the Communications menu, select *Connect* (if *Connect* is grayed out, select *Disconnect and reconnect*). Seaterm485 will attempt to connect at the baud specified in Step A, but if unsuccessful will then cycle through all other available baud rates.
- C. If there is still no communication, check cabling between the computer and MicroCAT, and try to connect again.
- D. If there is still no communication, repeat Step A with a different comm port and/or different fixed ID, and try to connect again.

**Notes:**

- For reliable operation, all commands **may** need to be preceded with two **@** characters to clear the MicroCAT's communication buffers. Seaterm485 precedes all automatically generated commands with **@@**.  
*Example* (query for MicroCAT ID):  
**@@id?**
- **#iiGetHD** provides factory-set data such as instrument type, serial number and firmware version.
- Seaterm485's baud rate must be the same as the MicroCAT baud rate (set with **#iiBaudRate=**). MicroCAT baud is factory-set to 9600, but can be changed by the user (see *Command Descriptions* in *Section 4: Deploying and Operating MicroCAT*). Other communication parameters – 8 data bits, 1 stop bit, and no parity – cannot be changed.
- Set to *Use fixed ID* to designate the appropriate MicroCAT if there are multiple MicroCATs on the RS-485 line. If desired, use *Automatically get instrument ID* if there is only 1 MicroCAT on the RS-485 line. Note that the ID is stored in the MicroCAT's EEPROM and can be changed so that multiple MicroCATs on a single RS-485 line each have a unique ID. See the Configuration Sheet for the factory-set ID.

Taking a look at the Send Commands window:

**Note:**  
The Send Commands window indicates *SBE37SM* because the 37-SMP uses the same firmware as the 37-SM.

These commands are **not** preceded by #ii prefix.

These commands are preceded by #ii prefix, directing them to a specific MicroCAT.

Click on desired command description in list.

Help box describes selected command in more detail.

Enter any command arguments (such as starting and ending sample number for upload) in these boxes.

Click Execute when ready to send selected command.

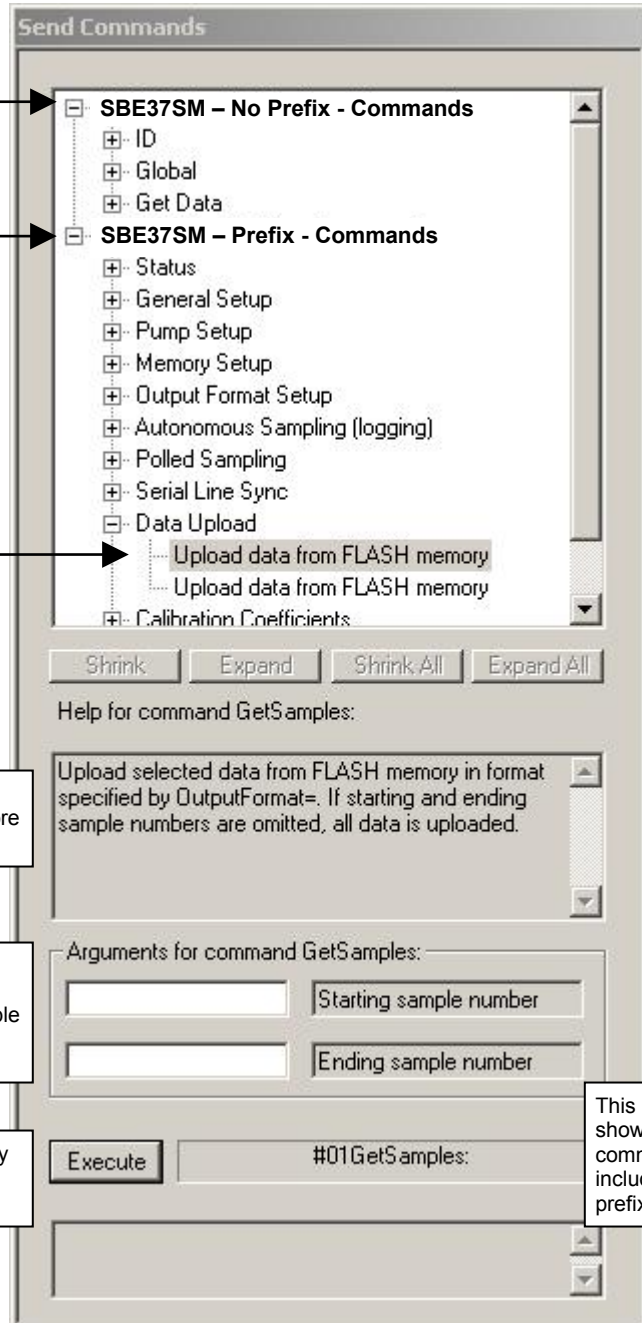

You can use the Send Commands window to send commands, or simply type the commands in the Command/Data Echo area if desired.

**Notes:**

- You may need to send the **#iiStop** command (type **#iiStop** and press the Enter key) to interrupt sampling, depending on how the instrument was set up the last time it was used. You may need to send **#iiStop** several times to get the MicroCAT to respond.
- The status display indicates **SBE37-SM** because the 37-SMP uses the same firmware as the 37-SM.
- The MicroCAT has a timeout algorithm. If it does not receive a command or sample data for 2 minutes, it powers down its communication circuits, placing it in quiescent (sleep) state and drawing minimal current. If the system does not appear to respond, select **Connect** in the Communications menu to reestablish communications, send two **@** characters, or press any key to reestablish communications.

**CAUTION:**

The MicroCAT **always** runs the pump in response to polled sampling commands (**#iiTS**, etc.), regardless of the conductivity frequency from the last sample and the setting for **#iiMinCondFreq**.

**Do not run the pump dry.** The pump is water lubricated; running it without water will damage it. If briefly testing your system with polled sampling commands in dry conditions, orient the MicroCAT to provide an upright U-shape for the plumbing. Then fill the inside of the pump head with water via the pump exhaust tubing. This will provide enough lubrication to prevent pump damage during brief testing.

**Note:**

**If more than one MicroCAT is on-line when you set the ID, all MicroCATs will be set to the same ID.**

5. Display MicroCAT status information by typing **#iiDS** (**ii** = MicroCAT ID) and pressing the Enter key. The display looks like this:

```
SBE37-SM 485 V 3.0h SERIAL NO. 0011 20 Oct 2010 08:49:08
vMain = 8.08, vLith = 3.08
samplenum = 0, free = 559240
not logging, never started
sample interval = 30 seconds
data format = converted engineering
sync mode = no
pump installed = yes, minimum conductivity frequency = 3000.0
RS485TxDelay = 25
RS485RxDelay = 25
```

6. Command the MicroCAT to take a sample by typing **#iiTS** (**ii** = MicroCAT ID) and pressing the Enter key. The display looks like this (if optional pressure sensor installed, **#iiOutputFormat=1** [data format = converted engineering], and not outputting salinity, sound velocity, density, or depth):

```
01, 03709999, 23.7658, 0.00019, 0.062,
20 Oct 2010, 08:50:08
```

where        01 = MicroCAT ID  
               03709999 = MicroCAT serial number  
               23.7658 = temperature in degrees Celsius  
               0.00019 = conductivity in S/m  
               0.062 = pressure in decibars  
               20Oct 2010 = date  
               08:50:08 = time

These numbers should be reasonable; i.e., room temperature, zero conductivity, barometric pressure (gauge pressure), current date and time (shipped from the factory set to Pacific Daylight or Standard Time).

7. Each MicroCAT on an RS-485 line must have a unique ID for communicating with the computer. Set the ID as described below, first verifying that only one MicroCAT is on-line before you set the ID:
  - A. Set the MicroCAT ID by typing **\*ID=ii** (**ii** = user-assigned ID number) and pressing the Enter key.
  - B. The computer responds by requesting verification, requiring you to again type **\*ID=ii** and press the Enter key.
  - C. Record the ID for future reference.
  - D. If you have Seaterm485 configured to *Use fixed id* – Select **Configure** in the Communications menu. In the Configure Communications dialog box, enter the new fixed ID and click OK.
  - E. Select **Disconnect and reconnect** in the Communications menu. Seaterm485 should connect to the MicroCAT, using its new ID.
8. Send other commands as desired.
9. Command the MicroCAT to go to sleep (quiescent state) by typing **PwrOff** and pressing the Enter key.

The MicroCAT is ready for programming and deployment.

# Section 4:

## Deploying and Operating MicroCAT

This section includes:

- System operation
- Sampling modes with example sets of operation commands
- Cable length limitations for real-time data transmission
- Cable termination
- Detailed command descriptions
- Data formats
- Optimizing data quality / deployment orientation
- Deploying and recovering the MicroCAT
- Uploading and processing data from the MicroCAT's memory

---

### Operation Description

A command prefix (**#ii**) directs commands to a MicroCAT with the same ID (ii = ID). Global commands do not require a prefix and are recognized by all MicroCATs attached to the RS-485 interface.

There is a user-programmable delay (**#iiRxDelay=**, default 25 milliseconds) after the MicroCAT receives a command, until the transmitter is enabled. Similarly, there is a user-programmable delay (**#iiTxDelay=**, default 25 milliseconds) after the MicroCAT transmits a reply until the transmitter is disabled. These built-in delays prevent transmissions and responses from interfering with each other.

**Note:**

In autonomous sampling and serial line sync modes, the pump runs only if the conductivity frequency from the last sample was greater than the minimum conductivity frequency for running the pump (**#iiMinCondFreq=**). Checking the conductivity frequency prevents the pump from running in air for long periods of time, which could damage it. See *Command Descriptions* for details on setting the minimum conductivity frequency.

The MicroCAT's integral pump runs for 1.0 second before each sample. The pump flushes the previously sampled water from the conductivity cell and brings a new water sample quickly into the cell. Water does not freely flow through the conductivity cell between samples, minimizing fouling.

## Sampling Modes

The MicroCAT has three basic sampling modes for obtaining data:

- Polled Sampling – On command, the MicroCAT runs the pump, takes one sample, and transmits the data.
- Autonomous Sampling – At pre-programmed intervals, the MicroCAT wakes up, runs the pump, samples, stores data in memory, and goes to sleep.
- Serial Line Synchronization – In response to a pulse on the serial line, the MicroCAT wakes up, runs the pump, samples, stores data in memory, transmits the data (if **#iiTxSyncMode=Y**), and goes to sleep.

Commands can be used in various combinations to provide a high degree of operating flexibility.

Descriptions and examples of the sampling modes follow for a system with three MicroCATs (IDs 01, 02, and 03) online. Note that the MicroCATs' response to each command is not shown in the examples. Review the operation of the basic sampling modes and the commands described in *Command Descriptions* before setting up your system.

### CAUTION:

**Do not run the pump dry.** The pump is water lubricated; running it without water will damage it. If briefly testing your system in dry conditions, orient the MicroCAT to provide an upright U-shape for the plumbing. Then fill the inside of the pump head with water via the pump exhaust tubing. This will provide enough lubrication to prevent pump damage during brief testing.

### Polled Sampling

On command, the MicroCAT runs the pump for 1.0 second and then takes one sample of data. Output of data to the computer and storing of data in the MicroCAT's FLASH memory is dependent on the particular command used.

Note that the pump runs automatically in response to a polled sampling command, regardless of the setting for the minimum conductivity frequency (**#iiMinCondFreq=**).

*Example: Polled Sampling* (user input in bold)

Wake up all MicroCATs. Globally set current date and time to September 1, 2008 9 am. For each MicroCAT: set up to output salinity. After all parameters are entered, verify setup. Send power-off command to all MicroCATs.

(Select *Connect* in Seaterm485's Communications menu to connect and wake up all MicroCATs.)

**DATEIME=09012008090000**

**#01OUTPUTSAL=Y**

**#01GETCD** (to verify setup)

(repeat **#iiOUTPUTSAL=Y** through **#iiGETCD** for MicroCATs 02 and 03)

**PWROFF**

To take **samples that are synchronized**: Wake up all MicroCATs. Simultaneously command all MicroCATs to take a sample, command each MicroCAT to transmit sample data to computer. Send power-off command to all MicroCATs.

(Select *Connect* in Seaterm485's Communications menu to connect and wake up all MicroCATs.)

**GDATA** (All MicroCAT pumps run for 1.0 second, and all MicroCATs take a sample.)

**DATA01**

**DATA02**

**DATA03**

**PWROFF**

(Repeat this process at periodic intervals as desired.)

To take **samples that are not synchronized**: Wake up all MicroCATs. Command each MicroCAT to take a sample and send sample data to computer. Send power-off command to all MicroCATs.

(Select *Connect* in Seaterm485's Communications menu to connect and wake up all MicroCATs.)

**#01TS** (Pump for MicroCAT 01 runs for 1.0 second, and MicroCAT 01 takes a sample.)

**#02TS** (Pump for MicroCAT 02 runs for 1.0 second, and MicroCAT 02 takes a sample.)

**#03TS** (Pump for MicroCAT 03 runs for 1.0 second, and MicroCAT 03 takes a sample.)

**PWROFF**

(Repeat this process at periodic intervals as desired.)

## Autonomous Sampling (Logging commands)

### Notes:

- If the FLASH memory is filled to capacity, autonomous sampling stops (i.e., the MicroCAT does not overwrite the data in memory).
- Use **#iiStop** to:
  - stop logging.
  - stop waiting to start logging (after **#iiStartLater** has been sent).
 Once **#iiStop** is sent, the MicroCAT will accept all commands again.

The MicroCAT samples data at pre-programmed intervals, defined by **#iiSampleInterval**. For each sample, the MicroCAT wakes up, the pump runs for 1.0 second (if the conductivity frequency from the last sample was greater than **#iiMinCondFreq**=), the MicroCAT samples and stores the data in its FLASH memory, and the MicroCAT goes to sleep (enters quiescent state). Logging is started with **#iiStartNow** or **#iiStartLater**, and is stopped with **#iiStop**. **#iiSL** can be used to obtain the last data sample without interrupting data acquisition.

The MicroCAT has a *lockout* feature to prevent unintended interference with sampling. If the MicroCAT is logging or is waiting to start logging (**#iiStartLater** has been sent, but logging has not started yet), the MicroCAT will only accept: **GData**, **PwrOff**, **Dataii**, **ID?**, **#iiGetCD**, **#iiGetSD**, **#iiGetCC**, **#iiGetEC**, **#iiGetHD**, **#iiDS**, **!iiDS**, **#iiDC**, **#iiTS**, **#iiTSR**, **#iiTSH**, **#iiSL**, **#iiSLT**, and **#iiStop**.

*Example: Autonomous Sampling* (user input in bold)

Wake up all MicroCATs. Globally set date and time for all MicroCATs to 05 September 2008, 12:00:00. For each MicroCAT: initialize logging to overwrite previous data in memory; set up to sample every 20 seconds; and start on 10 September 2008 at 12:00:00. After all parameters are entered, verify setup. Send power-off command to MicroCATs – system will automatically wake up and go to sleep for each sample.

(Select *Connect* in Seaterm485's Communications menu to connect and wake up all MicroCATs.)

**DATETIME=09052008120000**

**#01INITLOGGING**

**#01SAMPLEINTERVAL=20**

**#01STARTDATETIME=09102008120000**

**#01STARTTLATER**

**#01GETCD** (to verify setup)

(repeat **#iiINITLOGGING** through **#iiGETCD** for MicroCATs 02 and 03)

**PWROFF**

After logging begins, send global command to each MicroCAT to take a sample. Then send command to each MicroCAT to transmit data, and go to sleep:

(Select *Connect* in Seaterm485's Communications menu to connect and wake up all MicroCATs.)

**GDATA** (each pump runs for 1 second, and each MicroCAT takes a sample.)

**DATA01**

**DATA02**

**DATA03**

**PWROFF**

When ready to upload all data to computer, wake up all MicroCATs, stop sampling, upload data, and go to sleep:

(Select *Connect* in Seaterm485's Communications menu to connect and wake up all MicroCATs.)

**#01STOP**

(Click Upload menu – Seaterm485 leads you through screens to define data to be uploaded and where to store it.)

(Repeat **#iiSTOP** and upload for MicroCATs 02 and 03.)

**PWROFF**



## Serial Line Synchronization (Serial Line Sync)

### Notes:

- Use **#iiGetCD** or **#iiDS** to view Serial Line Sync enable/disable status.
- If the FLASH memory is filled to capacity, serial line sync sampling can continue, but additional data is not written to memory (i.e., the MicroCAT does not overwrite the data in memory).

Serial Line Sync allows a simple pulse (or a single character) on the RS-485 line to initiate a sample. This mode provides easy integration with ADCPs or current meters, which can synchronize MicroCAT sampling with their own without drawing on their battery or memory resources.

If serial line sync mode is enabled (**#iiSyncMode=Y**), sending a pulse (for example, by pressing any key) causes the MicroCAT to wake up, run the pump for 1.0 second (if the conductivity frequency from the last sample was greater than **#iiMinCondFreq**), take a sample, store the data in FLASH memory, transmit the data (if **#iiTxSyncMode=Y**), and go to sleep. Note that data sampled via serial line sync mode cannot be transmitted real-time for systems with more than one MicroCAT on-line, because all of the MicroCATs will attempt to respond at the same time.

To disable serial line sync mode, press the Esc key twice within 3 seconds of sending a pulse.

*Example: Serial Line Sync* (user input in bold)

Wake up all MicroCATs. Globally set current date and time to September 1, 2008 9 am. For each MicroCAT: initialize logging to overwrite previous data in memory; enable serial line sync mode, disable transmission of real-time data. After all parameters are entered, verify setup. Send power-off command.

(Select *Connect* in Seaterm485's Communications menu to connect and wake up all MicroCATs.)

**DATEIME=09012008090000**

**#01INITLOGGING**

**#01SYNCMODE=Y**

**#01TXSYNCMODE=N**

**#01GETCD** (to verify setup)

(Repeat **#iiINITLOGGING** through **#iiGETCD** for MicroCATs 02 and 03.)

**PWROFF**

Take samples using serial line sync mode:

(Send a pulse [press any key] to wake up, run pump for 1.0 second, take 1 sample, store data in memory, go to sleep.)

(Repeat this process at periodic intervals as desired.)

When ready to upload all data to computer, wake up all MicroCATs, disable serial line sync, upload data, and power down:

(Send a pulse [press any key]. All MicroCATs wake up, run pump for 1.0 second, take sample, store data in memory.)

(Within 3 seconds, press Esc key twice to disable serial line sync.)

(Press Enter key.)

**#01GETCD** (to verify MicroCAT is communicating)

(Click Upload menu – Seaterm485 leads you through screens to define data to be uploaded and where to store it)

(Repeat **#iiGETCD** and upload for MicroCATs 02 and 03)

**PWROFF**

## Real-Time Data Acquisition

### Note:

If using external power, see *External Power* in *Section 2: Description of MicroCAT* for power limitations on cable length.

The MicroCAT can transmit data over up to 1200 meters of twisted pair wire cable, 26 AWG or smaller gauge (larger diameter).

If acquiring real-time data, click the Capture menu in Seaterm485 before you begin sampling. The data displayed in Seaterm485 will be saved to the designated file. Process the data as desired. Note that this real-time data file **cannot be processed by SBE Data Processing, as it does not have the required headers and format.** To process data with SBE Data Processing, upload the data from the MicroCAT's memory.

## Cable Termination

The MAX3471 transceivers used in the MicroCAT are designed for bi-directional data communications on multi-point bus transmission lines. MAX3471 is optimized for use in un-terminated buses used in low-power systems. Termination is probably not necessary; if needed, refer to the Maxim data sheet for MAX3471.

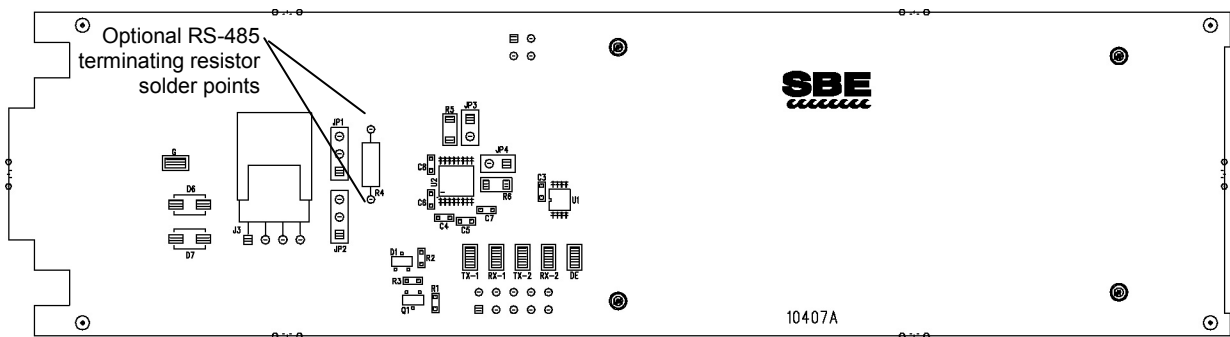

## Timeout Description

The MicroCAT has a timeout algorithm. If the MicroCAT does not receive a command for 2 minutes, it powers down its communication circuits to prevent exhaustion of the batteries. **To re-establish control, select *Connect* in Seaterm485's Communications menu, send two @ characters, or press any key.**

---

## Command Descriptions

This section describes commands and provides sample outputs. See *Appendix III: Command Summary Table* for a summarized command list.

When entering commands:

**Note:**

For reliable operation, all commands **may** need to be preceded with two @ characters. *Example* (status command for MicroCAT 01):  
@@#01DS

- Input commands to the MicroCAT in upper or lower case letters, and register commands by pressing the Enter key. Note that commands are shown with a mix of upper and lower case for ease in reading (for example, **#iiInitLogging**), but do not need to be entered that way.
- The MicroCAT sends an error message if an invalid command is entered.
- If a new command is not received within 2 minutes after the completion of a command, the MicroCAT returns to the quiescent (sleep) state.
- If in quiescent state, re-establish communications by selecting *Connect* in Seaterm485's Communications menu, sending two @ characters, or pressing any key.
- The MicroCAT responds only to **GData, PwrOff, Dataii, ID?, #iiGetCD, #iiGetSD, #iiGetCC, #iiGetEC, #iiGetHD, #iiDS, !iiDS, #iiDC, #iiTS, #iiTSR, #iiTSH, #iiSL, #iiSLT, and #iiStop** while sampling autonomously (**#iiStartNow** has been sent). If you wake the MicroCAT while it is sampling (for example, to send **#iiDS** to check on progress), it temporarily stops sampling. Autonomous sampling resumes when it goes back to sleep (either by sending **PwrOff** or after the 2-minute timeout).
- The MicroCAT responds only to **GData, PwrOff, Dataii, ID?, #iiGetCD, #iiGetSD, #iiGetCC, #iiGetEC, #iiGetHD, #iiDS, !iiDS, #iiDC, #iiTS, #iiTSR, #iiTSH, #iiSL, #iiSLT, and #iiStop** while waiting to start autonomous sampling (**#iiStartLater** has been sent). To send any other commands, send **#iiStop**, send the desired commands to modify the setup, and then send **#iiStartLater** again.

---

**MicroCAT ID Commands**

---

**Only one MicroCAT can be online when sending these commands.**

<b>ID?</b>	Get MicroCAT ID (ID = ii, where ii= 0-99).
<b>*ID=ii</b>	Set MicroCAT ID to <b>ii</b> , where ii= 0-99. <b>*ID=ii</b> must be sent twice, because computer requests verification. <b>If more than one MicroCAT is online when sending *ID=ii, all MicroCATs online will be set to same ID.</b>

**Note:**

**GData** causes all MicroCATs to sample at the same time. Because of the large sampling turn-on transient (0.5 Amps), if you use this command while *externally powering* more than one MicroCAT from the same power source, the power source must be able to supply 0.5 Amps for each MicroCAT simultaneously. See *External Power* in *Section 2: Description of MicroCAT* for power calculations.

**CAUTION:**

The MicroCAT **always** runs the pump in response to **GData** or a polled sampling command (**#iiTS**, **#iiTSH**, etc.), regardless of the conductivity frequency from the last sample and the setting for **#iiMinCondFreq**.

**Do not run the pump dry.** The pump is water lubricated; running it without water will damage it. If briefly testing your system with the **GData** command in dry conditions, orient the MicroCAT to provide an upright U-shape for the plumbing. Then fill the inside of the pump head with water via the pump exhaust tubing. This will provide enough lubrication to prevent pump damage during brief testing.

---

**Global Commands**

---

<b>DateTime=mmddyyyhhmmss</b>	Set real-time clock month, day, year, hour, minute, and second for <b>all</b> MicroCATs.
<b>GData</b>	Command <b>all</b> MicroCATs to run pump for 1.0 second and get one sample. Data is held in buffer until receiving <b>Dataii</b> . Data is <b>not</b> stored in FLASH memory.
<b>PwrOff</b>	Quit session and place <b>all</b> MicroCATs in quiescent (sleep) state. Main power is turned off. Data logging and memory retention are not affected.

**Note:**

In Seaterm485, to save data to a file, click the Capture menu before getting data.

---

**Get Data Command**

---

<b>Dataii</b>	Get data obtained with <b>GData</b> from MicroCAT with ID = ii.
---------------	---

All remaining commands are preceded by **#ii** (ii= MicroCAT ID [0-99]).

---

### Status Command

---

#### #iiGetCD

Get and display configuration data, which includes parameters related to MicroCAT setup. Most of these parameters can be user-input/modified. List below includes, where applicable, command used to modify parameter:

- Device type, Serial number
- Optional pressure sensor installed?
- Reference pressure to use in calculations if no pressure sensor installed (only appears if pressure sensor not installed)  
[**#iiReferencePressure=**]
- Pump installed  
[**#iiSetPumpInstalled=Y**]?  
Always yes for 37-SMP
- Minimum conductivity frequency for pump turn-on [**#iiMinCondFreq=**]
- Output data format [**#iiOutputFormat=**]
- Output salinity with each sample  
[**#iiOutputSal=**]?
- Output sound velocity with each sample  
[**#iiOutputSV=**]?
- Output depth with each sample  
[**#iiOutputDepth=**]?
- Latitude for depth calculation  
[**#iiLatitude=**]
- Output density with each sample  
[**#iiOutputDensity=**]?
- Interval between samples for autonomous sampling [**#iiSampleInterval=**]
- Serial sync mode enabled  
[**#iiSyncMode=**]?
- Transmit real-time data in serial line sync mode [**#iiTxSyncMode=**]?
- RS-485 transmitter enable delay  
[**#iiRxDelay=**]
- RS-485 transmitter disable delay  
[**#iiTxDelay=**]

#### Notes:

- All the status responses indicate *SBE37-SM* because the 37-SMP uses the same firmware as the 37-SM. The internal pump is applicable to the 37-SMP only.
- **#iiGetCD** output does not include calibration coefficients. To display calibration coefficients, use the **#iiGetCC** command.

*Example:* MicroCAT with a pressure sensor, with ID=03 (user input in bold, command used to modify parameter in parentheses).

#### #03GETCD

```

<ConfigurationData DeviceType = 'SBE37SM-RS485' SerialNumber = '03709999>
  <PressureInstalled>yes</PressureInstalled>
  <PumpInstalled>yes</PumpInstalled>
  <MinCondFreq>3000.0</MinCondFreq>
  <SampleDataFormat>raw Decimal</SampleDataFormat>
  <OutputSalinity>yes</OutputSalinity>
  <OutputSV>yes</OutputSV>
  <OutputDepth>yes</OutputDepth>
  <Latitude>0.0</Latitude>
  <OutputDensity>yes</OutputDensity>
  <SampleInterval>15</SampleInterval>
  <SyncMode>no</Syncmode>
  <TxSyncMode>no</TxSyncmode>
  <Rs485RxDelay>25</Rs485RxDelay>
  <Rs485TxDelay>25</Rs485TxDelay>
</ConfigurationData>

```

(inclusion of optional pressure sensor set at factory)  
[**#iiSetPumpInstalled=Y**; only valid setting for 37-SMP]  
[**#iiMinCondFreq=**]  
[**#iiOutputFormat=**]  
[**#iiOutputSalinity=**]  
[**#iiOutputSV=**]  
[**#iiOutputDepth=**]  
[**#iiLatitude=**]  
[**#iiOutputDensity=**]  
[**#iiSampleInterval=**]  
[**#iiSyncMode=**]  
[**#iiTxSyncMode=**]  
[**#iiRxDelay=**]  
[**#iiTxDelay=**]

**Status Commands** (*continued*)**#iiGetSD**

Get and display status data, which contains data that changes while deployed.

List below includes, where applicable, command used to modify parameter:

- Device type, Serial number
- Date and time [**DateTime=** or **#iiDateTime=**] in ISO8601-2000 extended format (yyyy – mm-ddThh:mm:ss)
- Number of recorded events in event counter [reset with **#iiResetEC**]
- Voltages – main battery voltage and back-up lithium battery voltage
- Memory – [reset with **#iiInitLogging**]
  - Number of bytes in memory
  - Number of samples in memory
  - Number of additional samples that can be placed in memory
  - Length (number of bytes) of each sample
- Logging status – yes or no (to indicate whether it is currently logging data); if applicable, reason that logging has stopped

*Example:* MicroCAT with ID=03 (user input in bold, command used to modify parameter in parentheses)

**#03getsd**

```
<StatusData DeviceType = 'SBE37SM-RS485' SerialNumber = '03709999'>
  <DateTime>2010-10-20T00:48:32</DateTime> [DateTime= or #iiDateTime=]
  <EventSummary numEvents = '0'> [can clear with #iiResetEC=]
  <Power>
    <vMain> 7.41</vMain>
    <vLith> 3.16</vLith>
  </Power>
  <MemorySummary>
    <Bytes>0</Bytes>
    <Samples>0</Samples> [can clear with #iiInitLogging]
    <SamplesFree>559240</SamplesFree> [can clear with #iiInitLogging]
    <SampleLength>15</SampleLength>
  </MemorySummary>
  <AutonomousSampling>no, stop command</AutonomousSampling> [#iiStartNow or #iiStartLater, #iiStop]
</StatusData>
```

**Status Commands (continued)****Note:**

Dates shown are when calibrations were performed.

**#iiGetCC**

Get and display calibration coefficients, which are initially factory-set and should agree with Calibration Certificates shipped with MicroCAT.

Example: MicroCAT with a pressure sensor with ID=03 (user input in bold, command used to modify parameter in parentheses)

**#03getcc**

```

<CalibrationCoefficients DeviceType = 'SBE37SM-RS485' SerialNumber = '03709999'>
  <Calibration format = 'TEMP1' id = 'Temperature'>
    <SerialNum>03709999</SerialNum>
    <CalDate>04-Oct-10</CalDate>                                [#iiTCalDate=]
    <A0>6.947802e-05</A0>                                       [#iiTA0=]
    <A1>2.615233e-04</A1>                                       [#iiTA1=]
    <A2>-1.265233e-06</A2>                                       [#iiTA2=]
    <A3>1.310479e-07</A3>                                       [#iiTA3=]
  </Calibration>
  <Calibration format = 'WBCOND0' id = 'Conductivity'>
    <SerialNum>03709999</SerialNum>
    <CalDate>04-Oct-10</CalDate>                                [#iiCCalDate=]
    <G>-1.009121e+00</G>                                       [#iiCG=]
    <H>1.410162e-01</H>                                       [#iiCH=]
    <I>-2.093167e-04</I>                                       [#iiCI=]
    <J>3.637053e-05</J>                                       [#iiCJ=]
    <PCOR>-9.570000e-08</PCOR>                                       [#iiCTCor=]
    <TCOR>3.250000e-06</TCOR>                                       [#iiCPCor=]
    <WBOTC>1.954800e-05</WBOTC>                                       [#iiCWBOTC=]
  </Calibration>
  <Calibration format = 'STRAIN0' id = 'Pressure'>
    <SerialNum>2478619</SerialNum>
    <CalDate>01-Oct-10</CalDate>                                [#iiPCalDate=]
    <PA0>1.729067e+00</PA0>                                       [#iiPA0=]
    <PA1>1.415754e-01</PA1>                                       [#iiPA1=]
    <PA2>1.246912e-08</PA2>                                       [#iiPA2=]
    <PTCA0>2.243971e+00</PTCA0>                                       [#iiPTCA0=]
    <PTCA1>1.055267e+00</PTCA1>                                       [#iiPTCA1=]
    <PTCA2>-2.276308e-02</PTCA2>                                       [#iiPTCA2=]
    <PTCB0>1.003849e+02</PTCB0>                                       [#iiPTCB0=]
    <PTCB1>1.014510e-02</PTCB1>                                       [#iiPTCB1=]
    <PTCB2>-2.057110e-04</PTCB2>                                       [#iiPTCB2=]
    <PTEMPA0>5.669780e+01</PTEMPA0>                                       [#iiPTempA0=]
    <PTEMPA1>-5.474043e-02</PTEMPA1>                                       [#iiPTempA1=]
    <PTEMPA2>1.267908e-05</PTEMPA2>                                       [#iiPTempA2=]
    <POFFSET>0.000000e+00</POFFSET>                                       [#iiPOffset= (decibars)]
    <PRANGE>0.000000e+00</PRANGE>                                       [#iiPRange= (psi)]
  </Calibration>
</CalibrationCoefficients>

```

**Status Commands** (*continued*)**#iiGetEC**

Get and display event counter data, which can help to identify root cause of a malfunction. Event counter records number of occurrences of common timeouts, power-on resets, etc. Can be cleared with **#iiResetEC**. Possible events that may be logged include:

- WDT reset – unexpected reset
- PON reset - power cycled on (each time power is applied)
- ErrorADC12TimeOut – response delayed from A/D converter that measures main power and back-up lithium battery power
- ErrorUART0TimeOut – timeout for transmitter to finish transmitting previous character
- ErrorAD7714TimeOut – response delayed from temperature and pressure A/D converter
- ErrorInvWakeUpFlag – unexpected wakeup
- ErrorFLASHTimeOut – problem with writing data to FLASH memory
- Alarm long - time to take next sample is too far in future
- Alarm short - woke up MicroCAT to send a command while logging, and missed taking a sample
- LoggingRestartNoAlarm – no sample taken for 8 hours while logging, restart logging
- LoggingRestartPON – power cycled while logging, logging restarted

*Example:* MicroCAT with ID=03 (user input in bold, command used to modify parameter in parentheses)

**#03getec**

```
<EventCounters DeviceType = 'SBE37SM-RS485' SerialNumber = '03709999'>
  <EventSummary numEvents = '0' /> [can clear with #iiResetEC]
</EventCounters>
```

**#iiResetEC**

Delete all events in event counter (number of events displays in **#iiGetSD** response, and event details display in **#iiGetEC** response).



**Status Commands** (*continued*)**#iiGetHD**

Get and display hardware data, which is fixed data describing MicroCAT:

- Device type, Serial number
- Manufacturer
- Firmware version
- Firmware date
- PCB assembly number
- Manufacture date
- Sensor types and serial numbers

*Example:* MicroCAT with ID=03 (user input in bold, command used to modify parameter in parentheses)

**#03gethd**

```
<HardwareData DeviceType = 'SBE37SM-RS485' SerialNumber = '03709999'>
  <Manufacturer>Sea-Bird Electronics, Inc.</Manufacturer>
  <FirmwareVersion>3.0h</FirmwareVersion>
  <FirmwareDate>22 June 2010 9:30</FirmwareDate>
  <PCBAssembly>41609A</PCBAssembly>
  <PCBAssembly>41610A</PCBAssembly>
  <PCBAssembly>41611B</PCBAssembly>
  <MfgDate>28 May 2008</MfgDate>
  <FirmwareLoader>SBE 37 FirmwareLoader V 1.0</FirmwareLoader>
  <InternalSensors>
    <Sensor id = 'Temperature'>
      <type>temperature-1</type>
      <SerialNumber>03709999</SerialNumber>
    </Sensor>
    <Sensor id = 'Conductivity'>
      <type>conductivity-1</type>
      <SerialNumber>03709999</SerialNumber>
    </Sensor>
    <Sensor id = 'Pressure'>
      <type>strain-0</type>
      <SerialNumber>2478619</SerialNumber>
    </Sensor>
  </InternalSensors>
</HardwareData>
```

[**#iiSetPCBAssembly1=**]  
[**#iiSetPCBAssembly2=**]  
[**#iiSetPCBAssembly3=**]  
[**#iiSetMfgDate=**]  
  
[**#iiSetPressureInstalled=**]

**Status Commands** (*continued*)**Notes:**

- The **#iiDS** response contains similar information as the combined responses from **#iiGetSD** and **#iiGetCD**, but in a different format.
- An alternate form of this command (with the same output) is **!iiDS**.

**#iiDS**

Display operating status and setup.

List below includes, where applicable, command used to modify parameter.

- firmware version, serial number, date and time [**DateTime=** or **#iiDateTime=**]
- Main battery voltage and back-up lithium battery voltage
- Number of samples in memory [**#iiSampleNumber=**] and available sample space in memory
- Logging status (logging; not logging, stop command, waiting to start at . . . , low battery, out of memory, or never started; or unexpected mode)
- Sample interval time [**#iiSampleInterval=**]
- Output data format [**#iiOutputFormat=**]
- Output salinity with each sample [**#iiOutputSal=**?]  
Only displays if set to yes
- Output sound velocity with each sample [**#iiOutputSV=**?]  
Only displays if set to yes
- Output depth with each sample [**#iiOutputDepth=**? Latitude for depth calculation [**#iiLatitude=**? (Only displays if output depth set to yes).
- Output density with each sample [**iiOutputDensity=**?]  
Only displays if set to yes
- Serial line sync mode enabled [**#iiSyncMode=**?]
- Transmit real-time data in serial line sync mode [**#iiTxSyncMode=**? Only displays if sync mode enabled
- Pump installed [**#iiSetPumpInstalled=Y**] (always installed in 37-SMP)?  
Minimum conductivity frequency for pump turn-on [**#iiMinCondFreq=**]
- Reference pressure to use in calculations if no pressure sensor installed (only appears if pressure sensor not installed) [**#iiReferencePressure=**]
- RS-485 transmitter disable delay [**#iiTxDelay=**]
- RS-485 transmitter enable delay [**#iiRxDelay=**]

*Example:* MicroCAT with a pressure sensor, with ID=03 (user input in bold, command used to modify parameter in parentheses).

**#03DS**

```

SBE37-SM 485 V 3.0h SERIAL NO. 0011 20 Oct 2010 08:49:08           [DateTime= or #iiDateTime=]
vMain = 8.08, vLith = 3.08
samplenumber = 77, free = 559163                                   [#iiSampleNumber=]
not logging, stop command                                         [#iiSampleInterval=]
sample interval = 15 seconds                                       [#iiOutputFormat=]
data format = converted engineering                                [#iiOutputSal=]
output salinity                                                    [#iiOutputSV=]
output sound velocity                                             [#iiOutputDensity=]
output density                                                     [#iiOutputDepth=, #iiLatitude=]
output depth, latitude = 0.0                                       [#iiSyncMode=]
sync mode = no                                                     [#iiSetPumpInstalled=Y; #iiMinCondFreq=]
pump installed = yes, minimum conductivity frequency = 3000.00   [#iiTxDelay=]
RS485TxDelay = 25                                                 [#iiRxDelay=]
RS485RxDelay = 25

```

**Status Commands** (*continued*)**Notes:**

- The **#iiDC** and **#iiGetCC** responses contain the same information, but in different formats.
- Dates shown are when calibrations were performed.

**#iiDC**

Display calibration coefficients, which are initially factory-set and should agree with Calibration Certificates shipped with MicroCAT.

*Example:* MicroCAT with a pressure sensor, with ID=03 (user input in bold, command used to modify parameter in parentheses).

**#03DC**

SBE37SM-RS485 V 3.0h 9999

temperature: 04-oct-10

TA0 = 6.947802e-05

TA1 = 2.615233e-04

TA2 = -1.265233e-06

TA3 = 1.310479e-07

conductivity: 04-oct-10

G = -1.036689e+00

H = 1.444342e-01

I = -3.112137e-04

J = 3.005941e-05

CPCOR = -9.570001e-08

CTCOR = 3.250000e-06

WBOTC = 1.968100e-05

pressure S/N 2478619, range = 2901 psia, 03-oct-10

PA0 = 0.000000e+00

PA1 = 0.000000e+00

PA2 = 0.000000e+00

PTCA0 = 0.000000e+00

PTCA1 = 0.000000e+00

PTCA2 = 0.000000e+00

PTCB0 = 0.000000e+00

PTCB1 = 0.000000e+00

PTCB2 = 0.000000e+00

PTEMPA0 = 0.000000e+00

PTEMPA1 = 0.000000e+00

PTEMPA2 = 0.000000e+00

POFFSET = 0.000000e+00

[#iiTCalDate=]

[#iiTA0=]

[#iiTA1=]

[#iiTA2=]

[#iiTA3=]

[#iiCCalDate=]

[#iiCG=]

[#iiCH=]

[#iiCI=]

[#iiCJ=]

[#iiCPCor=]

[#iiCTCor=]

[#iiCWBOTC=]

[#iiPRange=(psi), #iiPCalDate=]

[#iiPA0=]

[#iiPA1=]

[#iiPA2=]

[#iiPTCA0=]

[#iiPTCA1=]

[#iiPTCA2=]

[#iiPTCB0=]

[#iiPTCB1=]

[#iiPTCB2=]

[#iiPTempA0=]

[#iiPTempA1=]

[#iiPTempA2=]

[#iiPOffset=(decibars)]

---

**General Setup Commands**

---

**Notes:**

- The MicroCAT's baud rate (set with **#iiBaudRate=**) must be the same as Seaterm485's baud rate (set in the Communications menu).
- **#iiBaudRate=** must be sent twice. After the first entry, the MicroCAT changes to the new baud, and then waits for the command to be sent again at the new baud (In Seaterm485's Communications menu, select *Configure*. In the dialog box, select the new baud rate and click OK. Then retype the command.). This prevents you from accidentally changing to a baud that is not supported by your computer. If the MicroCAT does not receive the command again at the new baud, it reverts to the previous baud rate.

**#iiBaudRate=x**

x= baud rate (600, 1200, 2400, 4800, 9600, 19200, 38400, 57600, or 115200). Check capability of your computer and terminal program before increasing baud rate.  
**Command must be sent twice to change rate.**

**#iiRxDelay=x**

x= delay after MicroCAT receives a command until transmitter is enabled.  
 Range 0 – 500 milliseconds;  
 default 25 milliseconds.

**#iiTxDelay=x**

x= delay after MicroCAT transmits a reply until transmitter is disabled.  
 Range 0 – 500 milliseconds;  
 default 25 milliseconds.

**#iiDateTime=****mmddyyyyhhmmss**

Set real-time clock month, day, year, hour, minute, second.

*Example:* Set current date and time for MicroCAT with ID=03 to 10 January 2009 12:00:00 (user input in bold).

**#03DATETIME=01102009120000**

**#iiOutputExecutedTag=x**

x=**Y**: Display XML Executing and Executed tags. Executed tag displays at end of each command response; Executing tag displays one or more times if MicroCAT response to command requires additional time.

x=**N**: Do not.

*Example:* Set MicroCAT with ID=03 to output Executed and Executing tags (user input in bold).

**#03outputexecutedtag=y**

<Executed/>**#03getcd**

. . . (**#03GetCD** response)

<Executed/>

(Note: <Executed/> tag at end of command response takes place of S> prompt.)

**#iiReferencePressure=x**

x = reference pressure (gauge) in decibars. MicroCAT without installed pressure sensor uses this reference pressure in conductivity (and optional salinity, sound velocity, depth, and density) calculations. Entry ignored if MicroCAT includes pressure sensor.

---

### Pump Setup Commands

---

The SBE 37-SMP MicroCAT has an integral pump that is water lubricated; running it *dry* for an extended period of time will damage it. To prevent the pump from running dry while sampling in autonomous or serial line sync mode, the MicroCAT checks the raw conductivity frequency (Hz) from the last sample against the user-input minimum conductivity frequency (**#iiMinCondFreq=**). If the raw conductivity frequency is greater than **#iiMinCondFreq**, it runs the pump for 1.0 second before taking the sample; otherwise it does not run the pump.

If the minimum conductivity frequency is too close to the *zero conductivity frequency* (from the MicroCAT Calibration Sheet), the pump may turn on when the MicroCAT is in air, as a result of small drifts in the electronics. Some experimentation may be required to control the pump, particularly in fresh water applications.

**CAUTION:**

The MicroCAT **always** runs the pump in response to **GData** or a polled sampling command (**#iiTS**, **#iiTSH**, etc.), regardless of the conductivity frequency from the last sample and the setting for **#iiMinCondFreq=**.

**#iiMinCondFreq=x**

x= minimum conductivity frequency (Hz) to enable pump turn-on for autonomous or serial line sync mode sampling, to prevent pump from running before MicroCAT is in water. Pump does not run when conductivity frequency drops below **#iiMinCondFreq=**. MicroCAT Configuration Sheet lists uncorrected (raw) frequency output at 0 conductivity.

For salt water and estuarine applications, typical value (and factory-set default) for **#iiMinCondFreq=** (zero conductivity frequency + 500 Hz).

For fresh water applications, typical value for **#iiMinCondFreq=** (zero conductivity frequency + 5 Hz).

**CAUTION:**

**Do not run the pump dry.** The pump is water lubricated; running it without water will damage it. If briefly testing your system with the **#iiPumpOn** command in dry conditions, orient the MicroCAT to provide an upright U-shape for the plumbing. Then fill the inside of the pump head with water via the pump exhaust tubing. This will provide enough lubrication to prevent pump damage during brief testing.

**#iiPumpOn**

Turn pump on for testing purposes. Used to test pump or to run it to remove sediment from inside conductivity cell.

**Pump runs continuously during test, drawing current.** Send **#iiPumpOff** to stop test.

Note that:

1. MicroCAT does **not** check minimum conductivity frequency when user sends **#iiPumpOn**.
2. **#iiPumpOn** has no effect on pump operation while sampling.

**#iiPumpOff**

Turn pump off if it was turned on with **#iiPumpOn**. Note that **#iiPumpOff** has no effect on pump operation while sampling.

**Note:**

If the FLASH memory is filled to capacity, autonomous sampling stops (i.e., the MicroCAT does not overwrite the data in memory).

**Note:**

**Do not send #iiInitLogging or #iiSampleNumber=0 until all data has been uploaded.** These commands do not delete the data; they just reset the data pointer. **If you accidentally send one of these commands before uploading,** recover the data as follows:

1. Set **#iiSampleNumber=x**, where **x** is your estimate of number of samples in memory.
2. Upload data. If **x** is more than actual number of samples in memory, data for non-existent samples will be bad, random data. Review uploaded data file carefully and delete any bad data.
3. If desired, increase **x** and upload data again, to see if there is additional valid data in memory.

**Notes:**

- See *Data Formats* after the command descriptions for complete details.
- The MicroCAT does not store salinity, sound velocity, depth, or density in memory if those parameters are enabled. It calculates and outputs the values real-time or as data is uploaded; therefore, outputting these parameters has no effect on the number of samples that can be stored in memory.
- Salinity, sound velocity, depth, and/or density can also be calculated in SBE Data Processing, from data uploaded from the MicroCAT's memory.

**Memory Setup Commands****#iiInitLogging**

Initialize logging – after all previous data has been uploaded, initialize logging before starting to sample again to make entire memory available for recording. **#iiInitLogging** sets sample number (**#iiSampleNumber=**) to 0 (sampling will start with sample 1). **Command must be sent twice to initialize logging.** If not set to 0, data will be stored after last recorded sample. **Do not send #iiInitLogging until all existing data has been uploaded.**

**#iiSampleNumber=x**

**x**= sample number for last sample in memory. **Command must be sent twice to set sample number.** **#iiSampleNumber=0** is equivalent to **#iiInitLogging**. **Do not send #iiSampleNumber=0 until all existing data has been uploaded.**

**Output Format Setup Commands****#iiOutputFormat=x**

**x=0:** output raw decimal data.

**x=1** (default): output converted decimal data.

**x=2:** output converted decimal data in XML.

**x=3:** output converted decimal data, alternate format.

**#iiOutputSal=x**

**x=Y:** Calculate and output salinity (psu) with each sample. Only applies if **#iiOutputFormat=1, 2, or 3.**

**x=N** (default): Do not.

**#iiOutputSV=x**

**x=Y:** Calculate and output sound velocity (m/sec) with each sample, using Chen and Millero formula (UNESCO Technical Papers in Marine Science #44). Only applies if **#iiOutputFormat=1, 2, or 3.**

**x=N** (default): Do not.

**#iiOutputDepth=x**

**x=Y:** Calculate and output depth (meters) with each sample. Only applies if **#iiOutputFormat=1, 2, or 3.**

**x=N** (default): Do not.

**#iiOutputDensity=x**

**x=Y:** Calculate and output local density with each sample, based on salinity, temperature, and pressure. Only applies if **#iiOutputFormat=1, 2, or 3.**

Note: Local density = Sigma (s,t,p) - 1000

**x=N** (default): Do not.

**#iiLatitude=x**

**x**= latitude (degrees) to use in depth calculation. Applicable only if **#iiOutputDepth=Y.**

---

**Autonomous Sampling (Logging) Commands**

---

Logging commands direct the MicroCAT to run the pump and sample data at pre-programmed intervals, and store the data in its FLASH memory. Pump operation is dependent on the setting for **#iiMinCondFreq=**.

**Notes:**

- In Seaterm485, to save data to a file (if transmitting occasional samples while logging), click the Capture menu before beginning logging.
- If the FLASH memory is filled to capacity, autonomous sampling stops (i.e., the MicroCAT does not overwrite the data in memory).
- If the MicroCAT is sampling and the battery voltage is less than 6.15 volts for 5 consecutive scans, the MicroCAT halts logging.

**#iiSampleInterval=x**

**x=** interval between samples (6 – 21,600 seconds). When commanded to start sampling with **#iiStartNow** or **#iiStartLater**, MicroCAT takes measurement (running pump for 1.0 second before each measurement), stores data in FLASH memory, and goes to sleep (enters quiescent state) at **x** second intervals.

**#iiStartNow**

Start logging now, at rate defined by **#iiSampleInterval**. Data is stored in FLASH memory.

**#iiStartDateTime=mmddyyhhmmss**

Set delayed logging start month, day, year, hour, minute, second.

**Notes:**

- After receiving **#iiStartLater**, the MicroCAT displays `not logging: waiting to start` in reply to **#iiDS**. Once logging has started, the reply displays `logging`.
- If the delayed start time has already passed when **#iiStartLater** is received, the MicroCAT executes **#iiStartNow**.
- If the delayed start date and time is more than 30 days in the future when **#iiStartLater** is received, the MicroCAT assumes that the user made an error in setting the delayed start date and time, and it executes **#iiStartNow**.

**#iiStartLater**

Start logging at time set with delayed start date and time command, at rate defined by **#iiSampleInterval**. Data is stored in FLASH memory. If you need to change MicroCAT setup after **#iiStartLater** has been sent (but before logging has started), send **#iiStop**, change setup as desired, and then send **#iiStartLater** again.

*Example:* Program MicroCAT with ID=03 to start logging on 20 July 2009 12:00:00 (user input in bold).

```
#03STARTDATETIME=07202009120000
#03STARTLATER
```

**Note:**

You may need to send **#iiStop** several times to get the MicroCAT to respond. This is most likely to occur if sampling with a small **#iiSampleInterval**.

**#iiStop**

Stop logging (that was started with **#iiStartNow** or **#iiStartLater**) or stop waiting to start logging (if **#iiStartLater** was sent but logging has not begun yet). Press Enter key before entering **#iiStop**. **#iiStop** must be sent before uploading data from memory.

**CAUTION:**

The MicroCAT **always** runs the pump in response to **GData** or a polled sampling command (**#iiTS**, **#iiTSH**, etc.), regardless of the conductivity frequency from the last sample and the setting for **#iiMinCondFreq**.

**Do not run the pump dry.** The pump is water lubricated; running it without water will damage it. If briefly testing your system with a polled sampling command in dry conditions, orient the MicroCAT to provide an upright U-shape for the plumbing. Then fill the inside of the pump head with water via the pump exhaust tubing. This will provide enough lubrication to prevent pump damage during brief testing.

**Note:**

The MicroCAT has a buffer that stores the most recent data sample. Unlike data in the FLASH memory, data in the buffer is erased upon removal or failure of power.

---

**Polled Sampling Commands**

---

These commands are used to request a sample from the MicroCAT. Data from these commands is **not** stored in FLASH memory, except where noted.

<b>#iiTS</b>	Run pump for 1.0 second, take sample, store data in buffer, and output data.
<b>#iiTSR</b>	Run pump for 1.0 second, take sample, store data in buffer, and output data in raw decimal form (regardless of <b>#iiOutputFormat</b> ).
<b>#iiTSH</b>	Run pump for 1.0 second, take sample, store data in buffer (do not output data).
<b>#iiTSS</b>	Run pump for 1.0 second, take sample, store data in buffer and in <b>FLASH memory</b> , and output data. Note: MicroCAT ignores this command if sampling data ( <b>#iiStartNow</b> or <b>#iiStartLater</b> has been sent).
<b>#iiTSn:x</b>	Run pump continuously while taking <b>x</b> samples and outputting data. Note: MicroCAT ignores this command if sampling data ( <b>#iiStartNow</b> or <b>#iiStartLater</b> has been sent).
<b>#iiSL</b>	Output last sample stored in buffer.
<b>#iiSLT</b>	Output last sample stored in buffer. Then run pump for 1.0 second, take new sample, and store data in buffer (do not output data from new sample).

---

**Serial Line Sync Commands**

---

If serial line sync mode is enabled (**#iiSyncMode=Y**):

When a simple pulse (or a single character) is transmitted on the RS-485 line, the MicroCAT wakes up, runs the pump for 1.0 second, takes a sample, stores data in FLASH memory, transmits data (if **#iiTxSyncMode=Y**), and powers down. Pump operation is dependent on the setting for **#iiMinCondFreq**. Serial line sync mode is disabled by pressing the Enter key twice within 3 seconds of sending a pulse.

<b>#iiSyncMode=x</b>	<b>x=Y</b> : Enable serial line sync mode. <b>x=N</b> : Disable serial line sync mode.
<b>#iiTxSyncMode=x</b>	<b>x=Y</b> : Transmit real-time data when in serial line sync mode. Note that data sampled via serial line sync mode cannot be transmitted real-time for systems with more than one MicroCAT on-line, because all of the MicroCATs will attempt to respond at the same time. <b>x=N</b> : Do not transmit real-time data when in serial line sync mode.

**Notes:**

- In Seaterm485, to save data to a file (if transmitting data), click the Capture menu.
- If the FLASH memory is filled to capacity, serial line sync sampling can continue, but additional data is not written to memory (i.e., the MicroCAT does not overwrite the data in memory).
- See *Sampling Modes* for complete details on the operation of serial line synchronization.



---

**Data Upload Commands**

---

Send **#iiStop** before uploading data.

**Notes:**

- **Use Seaterm485's Upload menu to upload data that will be processed by SBE Data Processing.** Manually entering a data upload command does not produce data with the required header information and required format for processing by our software. These commands are included here for reference for users who are writing their own software.
- **If not using the Upload menu -** To save data to a file, click the Capture menu before entering a data upload command.
- See *Data Formats*.

**#iiGetSamples:b,e**

Upload data from scan **b** to scan **e**, in format defined by **#iiOutputFormat=**. First sample is number 1. As data is uploaded, screen first displays  
 start time =  
 start sample number =  
 These are start time and starting sample number for last set of logged data; can be useful in determining what data to review.

**#iiDDb,e**

Upload data from scan **b** to scan **e**, in alternate converted decimal form (**#iiOutputFormat=3**) (regardless of user setup for **#iiOutputFormat=**). First sample is number 1. As data is uploaded, screen first displays  
 start time =,  
 start sample number =.  
 These are start time and starting sample number for last set of logged data; can be useful in determining what data to review.

*Example:* Upload samples 1 to 200 for MicroCAT with ID=03 (user input in bold).

(Click Capture menu and enter desired filename in dialog box)

**#03GETSAMPLES : 1 , 200**

or

**#03DD1 , 200**

---

**Calibration Coefficients Commands**

---

Calibration coefficients are initially factory-set and should agree with Calibration Certificates shipped with the MicroCAT.

**Note:**

F = floating point number  
S = string with no spaces

*Temperature*

#iiTCalDate=S	S=Temperature calibration date
#iiTA0=F	F=Temperature A0
#iiTA1=F	F=Temperature A1
#iiTA2=F	F=Temperature A2
#iiTA3=F	F=Temperature A3

*Conductivity*

#iiCCalDate=S	S=Conductivity calibration date
#iiCG=F	F=Conductivity G
#iiCH=F	F=Conductivity H
#iiCI=F	F=Conductivity I
#iiCJ=F	F=Conductivity J
#iiWBOTC=F	F=Conductivity wbotc
#iiCTCor=F	F=Conductivity ctcor
#iiCPCor=F	F=Conductivity cpcor

*Pressure*

#iiPCalDate=S	S=Pressure calibration date
#iiPA0=F	F=Pressure A0
#iiPA1=F	F=Pressure A1
#iiPA2=F	F=Pressure A2
#iiPTCA0=F	F=Pressure ptca0
#iiPTCA1=F	F=Pressure ptca1
#iiPTCA2=F	F=Pressure ptca2
#iiPTCB0=F	F=Pressure ptcb0
#iiPTCB1=F	F=Pressure ptcb1
#iiPTCB2=F	F=Pressure ptcb2
#iiPTempA0=F	F=Pressure temperature a0
#iiPTempA1=F	F=Pressure temperature a1
#iiPTempA2=F	F=Pressure temperature a2
#iiPOffset=F	F=Pressure offset (decibars)

---

**Hardware Configuration Commands**

---

The following commands are used to set pump and pressure sensor configuration, manufacturing date, and PCB assembly numbers **at the factory**. Do not modify in the field.

**Notes:**

- The 37-SM and 37-SMP use the same firmware. The internal pump is applicable to the 37-SMP only.
- If you set #iiSetPumpInstalled=N, the MicroCAT will not operate the pump while sampling. **This is not recommended during deployment.** The U-shape plumbing restricts un-pumped flow through the conductivity cell, so a new sample of water will not be flushed through the cell for each measurement if the pump is turned off.

#iiSetPumpInstalled=Y (pump is always installed for 37-SMP)

#iiSetPressureInstalled= (pressure sensor is optional, and is factory installed)

#iiSetMfgDate=  
#iiSetPCBAssembly1=  
#iiSetPCBAssembly2=  
#iiSetPCBAssembly3=

## Data Formats

### Notes:

- Time is the time at the **start** of the sample.
- The MicroCAT's pressure sensor is an absolute sensor, so its **raw** output includes the effect of atmospheric pressure (14.7 psi). As shown on the Calibration Sheet, Sea-Bird's calibration (and resulting calibration coefficients) is in terms of psia. However, when outputting pressure in **decibars**, the MicroCAT outputs pressure relative to the ocean surface (i.e., at the surface the output pressure is 0 decibars). The MicroCAT uses the following equation to convert psia to decibars:  

$$\text{pressure (db)} = [\text{pressure (psia)} - 14.7] * 0.689476$$

Each scan ends with a carriage return <CR> and line feed <LF>.

- **#iiOutputFormat=0**: raw decimal data, intended for diagnostic use at Sea-Bird  
 tttttt, cccc.ccc, pppppp, vvvv, dd mmm yyyy, hh:mm:ss

#### where

tttttt = temperature A/D counts.

cccc.ccc = conductivity frequency (Hz).

pppppp = pressure sensor pressure A/D counts; sent only if optional pressure sensor installed.

vvvv = pressure sensor pressure temperature compensation A/D counts; sent only if optional pressure sensor installed.

dd mmm yyyy = day, month, year.

hh:mm:ss = hour, minute, second.

Note that salinity, sound velocity, depth, and density are not sent, regardless of the setting for those parameters. All data is separated with a comma and a space.

*Example:* Response to **Dataii** command for MicroCAT with ID=03, pressure sensor is installed, **#iiOutputFormat=0**:

524276, 2886.656, 785053, 2706, 20 Oct 2010, 09:01:34

(temperature, conductivity, pressure sensor pressure, pressure sensor temperature compensation, date, time)

- **#iiOutputFormat=1** (default): converted decimal data  
 ii, nnnnnnnn, tttt.tttt, ccc.cccccc, ppppp.ppp, dddd.ddd, ssss.ssss,  
 vvvvv.vvv, rrr.rrrr, dd mmm yyyy, hh:mm:ss

#### where

ii = MicroCAT ID (0 – 99); sent only in response to **Dataii** or polled sampling command (not sent in response to data upload command).

nnnnnnnn = MicroCAT serial number; sent only in response to **Dataii** or polled sampling command (not sent in response to data upload command).

tttt.tttt = temperature (°C, ITS-90).

ccc.cccccc = conductivity (S/m).

ppppp.ppp = pressure (decibars); sent only if optional pressure sensor installed.

dddd.ddd = depth (meters); sent only if **#iiOutputDepth=Y**

ssss.ssss = salinity (psu); sent only if **#iiOutputSal=Y**.

vvvvv.vvv = sound velocity (m/s); sent only if **#iiOutputSV=Y**.

rrr.rrrr = local density (kg/m<sup>3</sup>); sent only if **#iiOutputDensity=Y**.

dd mmm yyyy = day, month, year.

hh:mm:ss = hour, minute, second.

Leading zeros are suppressed, except for one zero to the left of the decimal point. All data is separated with a comma; serial number, date, and time are also preceded by a space.

*Example:* Response to **Dataii** command for MicroCAT with ID=03, pressure sensor is installed, **#iiOutputFormat=1**, **#iiOutputDepth=Y**, **#iiOutputSal=Y**, **#iiOutputSV=Y**, **#iiOutputDensity=Y**:

03, 03709999, 8.5796, 0.15269, 531.316, 527.021, 1.1348, 1451.478, 3.2486,  
 20 Oct 2010, 09:01:44

(ID, serial number, temperature, conductivity, pressure, depth, salinity, sound velocity, local density, date, time)

**Note:**

For ease in reading, the data structure is shown with each XML tag on a separate line. However, there are no carriage returns or line feeds between tags (see example below).

- **#iiOutputFormat=2:** converted decimal data in XML

```
<?xml version="1.0"?>
<datapacket>
<hdr>
<mfg>Sea-Bird</mfg>
<model>37sm</model>
<id>ii</id>
<sn>nnnnnnnn</sn>
</hdr>
<data>
<t1>tt.ttt</t1>
<c1>cc.ccccc</c1>
<p1>pppp.ppp </p1>
<dm>dddd.ddd</dm>
<sal>sss.ssss</sal>
<sv>vvvv.vvv</sv>
<sr>rrr.rrr</sr>
<dt>yyyy-mm-ddThh:mm:ss</dt>
</data>
</datapacket>
```

where

ii = MicroCAT ID (0 – 99).

nnnnnnnn = MicroCAT serial number.

tt.ttt = temperature (°C, ITS-90).

cc.ccccc = conductivity (S/m).

pppp.ppp = pressure (decibars); sent only if optional pressure sensor installed.

dddd.ddd = depth (meters); sent only if **#iiOutputDepth=Y**.

sss.ssss = salinity (psu); sent only if **#iiOutputSal=Y**.

vvvv.vvv = sound velocity (m/s); sent only if **#iiOutputSV=Y**.

rrr.rrr = local density (kg/m<sup>3</sup>); sent only if **#iiOutputDensity=Y**.

yyyy-mm-ddThh:mm:ss = year, month, day, hour, minute, second.

Leading zeros are suppressed, except for one zero to the left of the decimal point.

*Example:* Sample data output when pressure sensor is installed, **#iiOutputFormat=2**, **#iiOutputDepth=Y**, **#iiOutputSal=Y**, **#iiOutputSV=Y**, **#iiOutputDensity=Y**:

```
<?xml version="1.0"?><datapacket><hdr><mfg>Sea-Bird</mfg><model>37SM</model><id>03</id>
<sn>03709999</sn></hdr><data><t1> 8.5796</t1><c1> 0.15269</c1><p1> 531.316</p1>
<dm> 527.021</dm><sal> 1.1348</sal><sv>1451.478</sv><sr> 3.2486</sr>
<dt>2010-10-20T09:01:44</dt></data></datapacket> CRLF
(ID, serial number, temperature, conductivity, pressure, depth, salinity, sound velocity, local density, date and time)
```

**Note:**

This format is identical to the format from an SBE 37-SMP with **firmware < 3.0** and **#iiFormat=1**. It is provided for compatibility with systems programmed for those older instruments.

- **#iiOutputFormat=3**: converted decimal data, *alternate*  
ii, nnnnn,ttt.tttt,cc.cccccc, pppp.ppp, dddd.ddd, sss.ssss, vvvv.vvv, rrr.rrrr,  
dd mmm yyyy, hh:mm:ss

where

ii = MicroCAT ID (0 – 99); sent only in response to **Dataii** (not sent in response to polled sampling command or data upload command).

nnnnn = MicroCAT serial number (5 digits, omits the 037 prefix); sent only in response to **Dataii** or polled sampling command (not sent in response to data upload command).

ttt.tttt = temperature (°C, ITS-90).

cc.cccccc = conductivity (S/m).

pppp.ppp = pressure (decibars); sent only if optional pressure sensor installed.

dddd.ddd = depth (meters); sent only if **#iiOutputDepth=Y**.

sss.ssss= salinity (psu); sent only if **#iiOutputSal=Y**.

vvvv.vvv = sound velocity (meters/second); sent only if **#iiOutputSV=Y**.

rrr.rrrr = local density (kg/m<sup>3</sup>); sent only if **#iiOutputDensity=Y**.

dd mmm yyyy = day, month, year.

hh:mm:ss = hour, minute, second.

Leading zeros are suppressed, except for one zero to the left of the decimal point. There is a comma but no space before temperature and before conductivity. All other data is separated with a comma and a space.

*Example:* Response to **Dataii** command for MicroCAT with ID=03, pressure sensor is installed, **#iiOutputFormat=3**, **#iiOutputDepth=Y**, **#iiOutputSal=Y**, **#iiOutputSV=Y**, **#iiOutputDensity=Y**:

```
03, 09999, 8.5796, 0.15269, 531.316, 527.021, 1.1348, 1451.478, 3.2486,
20 Oct 2010, 09:01:44
(ID, serial number, temperature, conductivity, pressure, depth, salinity, sound velocity, local density, date, time)
```

## Optimizing Data Quality / Deployment Orientation

### Note:

A pump clogged with sediment results in poor flushing, causing poor quality data.

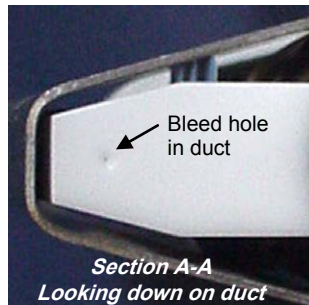
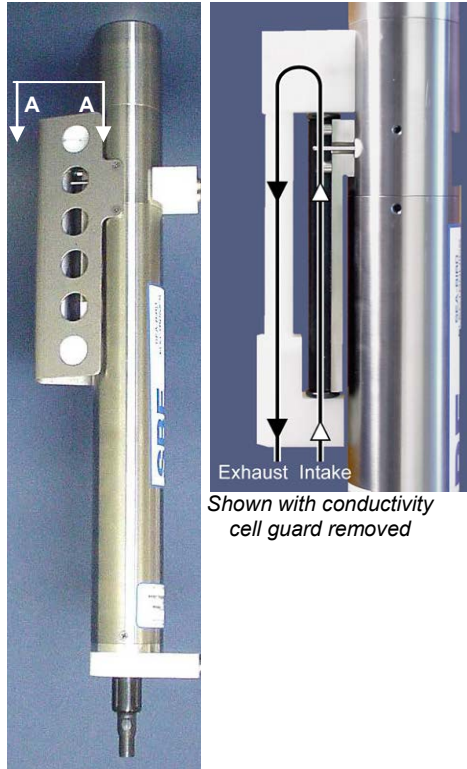

### Background Information

Sea-Bird's general recommendation is to deploy the MicroCAT with the plumbing in an **inverted** U-shape, to minimize the ingestion of sediment. A small bleed hole in the duct provides a way for air to exit the plumbing, so that the pump will prime and operate. In considering the effect of air on the pump, it can be instructive to look at the amount of air in the water column:

- **Case 1:** The top ~2 meters of the water column may contain a continuous supply of bubbles injected into the system by breaking waves. In this area, the ability to continuously eliminate air from the system, throughout the deployment, is of prime concern.
- **Case 2:** The next ~30 meters of the water column is not typically affected by bubbles from breaking waves. *Without a bleed hole*, it could take a few days to weeks after deployment for the air to clear out of the system in an inverted U-shape. However, once the air was bled, no more air would be injected into the plumbing.
- **Case 3:** Below ~30 meters, *without a bleed hole*, it could take only a few hours to a day for the air to clear out of the system in an inverted U-shape. As in Case 2, once the air was bled, no more air would be injected into the plumbing.

The bleed hole, while providing a way for air to exit the plumbing, also provides a little more ventilation; this ventilation will cause a slight decrease in the concentration of anti-foulant in the water held in the plumbing between samples. In our judgment, and the experience of customers, the risk of poor data due to sediment accumulation is usually greater than the risk of slightly reduced effectiveness of the anti-foulant, or is at least a reasonable trade-off.

### Deployment Recommendations

- **Most deployments** – Deploy the MicroCAT with the plumbing in an **inverted** U-shape (as shown in the photos), allowing air to exit the plumbing through the bleed hole.
- **Deployments where severe bio-fouling is the main concern and sediment is not an issue** –
  - Case A:* You need accurate data immediately upon deployment - Plug the bleed hole. Deploy the MicroCAT with the plumbing in an **upright** U-shape, providing maximum bio-foul protection but leaving the MicroCAT vulnerable to ingestion of sediment.
  - Case B:* You can skip some initial data, allowing time for trapped air to dissolve into the water and the pump to prime properly – **Plug the bleed hole**. Deploy the MicroCAT with the plumbing in an **inverted** U-shape, providing maximum bio-foul protection as well as protection from the ingestion of sediment. This deployment method will provide good data within a day if the deployment is deeper than ~30 meters. Eliminate scans associated with the initial deployment by evaluating the conductivity data; minimal changes in conductivity are an indication that pump flow is not correct because air in the plumbing has prevented the pump from priming.
- **Deployments where air bubbles are the main concern and sediment is not an issue - Plug the bleed hole.** Deploy the MicroCAT with the plumbing in an **upright** U-shape. This orientation provides better bleeding of air from the plumbing than can be achieved with the small bleed hole, but leaves the MicroCAT vulnerable to ingestion of sediment.
- **Deployments where (for mounting reasons) the preferred orientation is horizontal** – Sea-Bird does not recommend horizontal mounting, because sediment can accumulate in the conductivity cell, resulting in very poor quality conductivity data. **As a minimum, incline the MicroCAT 10 degrees above the horizontal** to prevent sediment accumulation and provide proper pump operation.

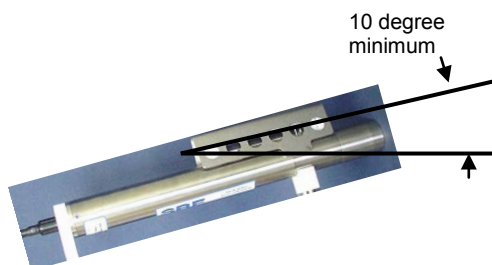

## Setup for Deployment

1. Install new batteries (see *Section 5: Routine Maintenance and Calibration*) or ensure the existing battery pack has enough capacity to cover the intended deployment.
2. Program the MicroCAT for the intended deployment (see *Section 3: Preparing MicroCAT for Deployment* for connection information; see information in this section on commands and sampling modes):
  - A. Ensure all data has been uploaded, and then send **#iiInitLogging** to make the entire memory available for recording.  
If **#iiInitLogging** is not sent, data will be stored after the last recorded sample.
  - B. Set the date and time. Date and time can be set globally for all MicroCATs online (**DateTime=**) or individually for each MicroCAT (**#iiDateTime=**). To synchronize autonomous sampling for a system with multiple MicroCATs online, set the date and time globally with all MicroCATs online (see *Autonomous Sampling* in this section for details on synchronization).
  - C. Establish the setup and logging parameters.
  - D. If the system will have multiple MicroCATs online, verify that Seaterm485 is set to *Use fixed ID* to allow use of Seaterm485's Send Commands window:
    - (1) In the Communications menu, select *Configure*.
    - (2) Click on *Use fixed ID*. Enter the MicroCAT's ID.
    - (3) Click OK.
  - E. Use **one** of the following sequences to initiate logging:
    - **#iiStartNow** to start logging now, taking a sample every **#iiSampleInterval** seconds.
    - **#iiStartDateTime=** and **#iiStartLater** to start logging at the specified date and time, taking a sample every **#iiSampleInterval** seconds.
    - **#iiSyncMode=Y** to place the MicroCAT in serial line sync mode, so that a simple pulse (or a single character) on the RS-485 line will initiate a sample.

## Deployment

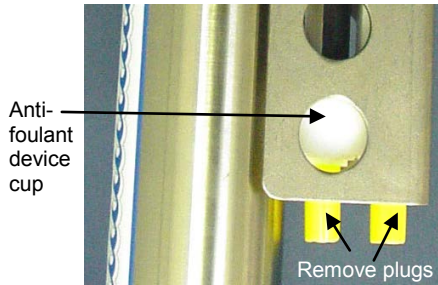

**CAUTION:**  
Do not use WD-40 or other petroleum-based lubricants, as they will damage the connectors.

Dummy plug or I/O cable connector (as applicable)

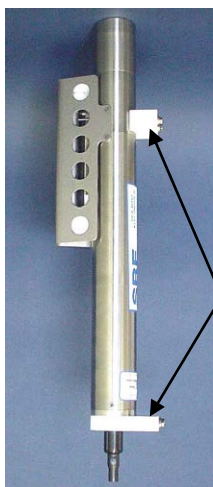
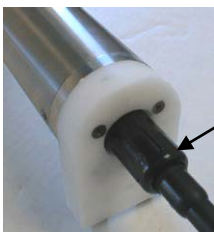
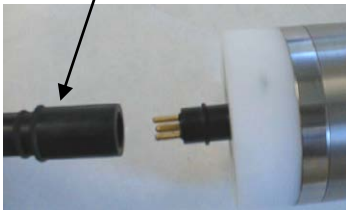

**For most applications, deploy in orientation shown (connector at bottom)**

Standard mounting clamp and guide – loosen hardware to separate clamp/guide halves and mount on mooring cable

The MicroCAT comes standard with a pre-installed Sea-Bird wire mounting clamp and guide.

1. New MicroCATs are shipped with AF24173 Anti-Foulant Devices and protective plugs pre-installed.
  - A. Remove the protective plugs, if installed, from the anti-foulant device cup. **The protective plugs must be removed prior to deployment or pressurization.** If the plugs are left in place during deployment, the sensor will not register conductivity. If left in place during pressurization, the cell may be destroyed.
  - B. Verify that the anti-foulant device cup contains AF24173 Anti-Foulant Devices (see *Section 5: Routine Maintenance and Calibration*).
2. Install the dummy plug or I/O cable:
  - A. Lightly lubricate the inside of the dummy plug or cable connector with silicone grease (DC-4 or equivalent).
  - B. **Standard Connector** (shown in photos) - Install the dummy plug or cable connector, aligning the raised bump on the side of the plug/connector with the large pin (pin 1 - ground) on the MicroCAT. Remove any trapped air by *burping* or gently squeezing the plug/connector near the top and moving your fingers toward the end cap. **OR**  
**MCBH Connector** – Install the plug/cable connector, aligning the pins.
  - C. Place the locking sleeve over the plug/connector. Tighten the locking sleeve finger tight only. **Do not overtighten the locking sleeve and do not use a wrench or pliers.**
3. Attach the mounting clamp and guide to the mooring cable. See *Optimizing Data Quality / Deployment Orientation* for deployment recommendations.
4. Verify that the hardware and external fittings are secure.
5. If desired, connect the MicroCAT to the computer and/or an external power supply. (See *Test Setup* in *Section 3: Preparing MicroCAT for Deployment*.)
6. If using Seaterm485 to view real-time data, click the Capture menu. Enter the desired capture file name in the dialog box, and click Save. Data displayed in Seaterm485 will be saved to the designated .cap file. The .cap file **cannot be processed by Sea-Bird software, as it does not have the required headers and format.**
7. Deploy the MicroCAT.



## Recovery

**WARNING!**

**If the MicroCAT stops working while underwater, is unresponsive to commands, or shows other signs of flooding or damage, carefully secure it away from people until you have determined that abnormal internal pressure does not exist or has been relieved.** Pressure housings may flood under pressure due to dirty or damaged o-rings, or other failed seals. When a sealed pressure housing floods at great depths and is subsequently raised to the surface, water may be trapped at the pressure at which it entered the housing, presenting a danger if the housing is opened before relieving the internal pressure. Instances of such flooding are rare. However, a housing that floods at 5000 meters depth holds an internal pressure of more than 7000 psia, and has the potential to eject the end cap with lethal force. A housing that floods at 50 meters holds an internal pressure of more than 85 psia; this force could still cause injury.

If you suspect the MicroCAT is flooded, point it in a safe direction away from people, and loosen the bulkhead connector very slowly, at least 1 turn. This opens an o-ring seal under the connector. Look for signs of internal pressure (hissing or water leak). If internal pressure is detected, let it bleed off slowly past the connector o-ring. Then, you can safely remove the end cap.

1. Rinse the conductivity cell with fresh water. (See *Section 5: Routine Maintenance and Calibration* for cell cleaning and storage.)
2. Reinsert the protective plugs in the anti-foulant device cup.
3. If the batteries are exhausted, new batteries must be installed before the data can be extracted. Stored data will not be lost as a result of exhaustion or removal of batteries. See *Section 5: Routine Maintenance and Calibration* for replacement of batteries.
4. If immediate redeployment is not required, you can leave the MicroCAT with batteries in place and in a quiescent state (**PwrOff**). Because the quiescent current required is only 30 microAmps, the batteries can be left in place without significant loss of capacity (less than 6% loss per year).

## Uploading and Processing Data

**Note:**

Data may be uploaded during deployment or after recovery. If uploading after recovery, wire the MicroCAT as described in *Power and Communications Test and Setting MicroCAT ID* in *Section 3: Preparing MicroCAT for Deployment*.

1. Double click on **SeatermV2.exe**. The main screen appears.
2. In the Instruments menu, select *SBE 37 RS485*. **Seaterm485** opens.
3. Seaterm485 tries to automatically connect to the MicroCAT. The connection attempt varies, depending on the configuration setting the last time Seaterm485 was used.
  - If Seaterm485 was set to *Automatically get instrument ID* the last time it was used – Seaterm485 sends **id?** and waits for a response from the MicroCAT. Once the ID response is received, Seaterm485 sends **#iiGetHD**, using the ID provided by the MicroCAT.
  - If Seaterm485 was set to *Use fixed ID* the last time it was used – Seaterm485 sends **#iiGetHD**, using the fixed ID that was entered the last time the software was used.

Seaterm485 then fills the Send Commands window with the correct list of commands for your MicroCAT.

**If there is no communication (no response to id? and/or no response to #iiGetHD):**

- A. In the Communications menu, select *Configure*. The Configure Communications dialog box appears. Select the Comm port and baud rate for communication. If using a fixed ID, verify that the designated ID is correct for the MicroCAT with which you want to communicate. Click OK.
- B. In the Communications menu, select *Connect* (if *Connect* is grayed out, select *Disconnect and reconnect*). Seaterm485 will attempt to connect at the baud specified in Step A, but if unsuccessful will then cycle through all other available baud rates.
- C. If there is still no communication, check cabling between the computer and MicroCAT, and try to connect again.
- D. If there is still no communication, repeat Step A with a different comm port and/or different fixed ID, and try to connect again.

**Note:**

For reliable operation, all commands **may** need to be preceded with two @ characters  
*Example* (MicroCAT with ID=01):  
 @@#01STOP

**Note:**

You may need to send **#iiStop** several times to get the MicroCAT to respond.

4. If sampling autonomously, command the MicroCAT to stop logging by pressing any key, typing **#iiStop** (ii=MicroCAT ID), and pressing the Enter key.
5. Display MicroCAT status information by typing **#iiDS** and pressing the Enter key. The display looks like this:

```
SBE37-SM 485 V 3.0h SERIAL NO. 0011 20 Oct 2010 08:49:08
vMain = 8.08, vLith = 3.08
samplenum = 32, free = 559208
not logging, stop command
sample interval = 30 seconds
data format = converted engineering
sync mode = no
pump installed = yes, minimum conductivity frequency = 3000.0
RS485TxDelay = 25
RS485RxDelay = 25
```

Verify that the status is **not logging**.

6. Click the Upload menu to upload stored data. Seaterm485 responds as follows:
  - A. Seaterm485 sends **#iiGetSD** and displays the response. **#iiGetSD** provides information on the instrument status, and number of samples in memory.
  - B. In the Save As dialog box, enter the desired upload file name and click Save. The upload file has a .XML extension
  - C. An Upload Data dialog box appears:

**Note:**  
If binary upload is selected, Seaterm485 uploads the data in binary and then converts it to ASCII text, resulting in a data file that is identical to one uploaded in ASCII text.

Select number of bytes uploaded in each block. Seaterm485 uploads data in blocks, and calculates a checksum at end of each block. If block fails checksum verification, Seaterm485 tries to upload block of data again, cutting block size in half.

Defines data upload type and range:

- All data as a single file – All data is uploaded into 1 file.
- By scan number range – Enter beginning scan (sample) number and total number of scans. All data within range is uploaded into 1 file.
- By address range – Enter beginning byte number and total number of bytes. Note that first byte in memory is byte 0. All data within range is uploaded into 1 file.

To change upload file name selected in Step B above, click Browse to navigate to desired upload file path and name. Upload file has a .xml extension. After Seaterm485 uploads data into .xml data file, it creates .hex data file and .xmlcon configuration file that are compatible with SBE Data Processing. These files are placed in same directory as .xml data file, and have same name (but different extensions).

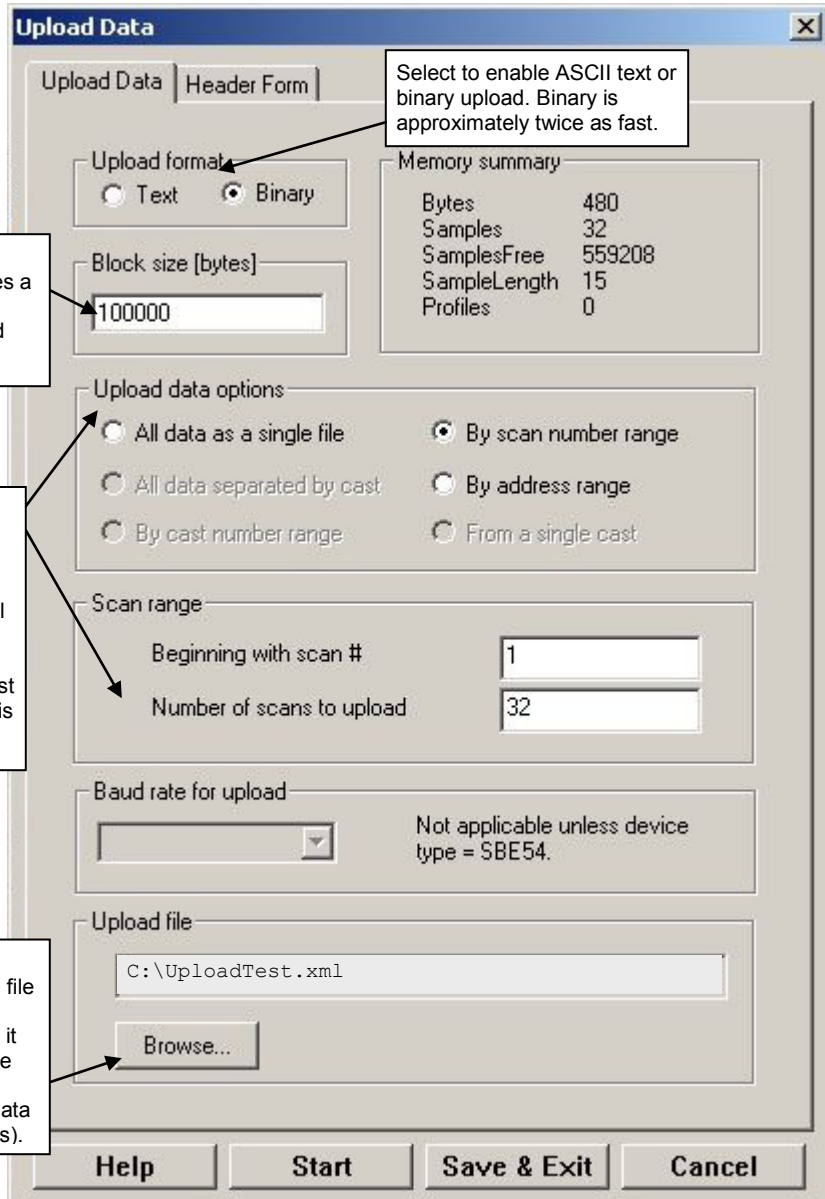

Make the desired selections.

## 7. Click the Header Form tab to customize the header:

Defines header information included with uploaded data:

- Prompt for header information – As data is uploaded, user is prompted to fill out user-defined header form.
- Include default header form in upload file – User-defined default header form included in upload file. User is not prompted to add any information when data is uploaded.
- Don't include default header form in upload file – Header information not included in upload file.

The entries are free form, 0 to 12 lines long. This dialog box establishes:

- the header prompts that appear for the user to fill in when uploading data, if *Prompt for header information* was selected
- the header included with the uploaded data, if *Include default header form in upload file* was selected

Enter the desired header/header prompts.

8. Click Start; the Status bar at the bottom of the window displays the upload progress:
  - A. Seaterm485 sends several status commands providing information regarding the number of samples in memory, calibration coefficients, etc., and writes the responses to the upload .xml file.
  - B. **If you selected *Prompt for header information in the Upload Data dialog box*** – a dialog box with the header form appears. Enter the desired header information, and click OK. Seaterm485 writes the header information to the upload .xml file.
  - C. Seaterm485 sends the data upload command, based on your selection of upload range in the Upload Data dialog box, and writes the data to the upload .xml file.
  - D. From the information in the .xml file, Seaterm485 creates a .hex data file and .xmlcon configuration file that are compatible with SBE Data Processing for processing and plotting the data. These files are placed in the same directory as the .xml data file and have the same name (but different extensions).

**Note:**

SeatermV2 with version < 1.1 did not convert the uploaded .xml data file to a .hex and .xmlcon file. *Convert .XML data file* in the Tools menu was used to convert the .xml data file to a .cnv file, which could be processed in SBE Data Processing. We recommend that you update your SeatermV2 software to 1.1b or later.

**Notes:**

- Ensure all data has been uploaded from the MicroCAT by reviewing the data in SBE Data Processing.
- If you do not run Data Conversion now, you can run it later by opening SBE Data Processing.
- See the SBE Data Processing manual and/or Help for details.

9. After the data has been uploaded, Seaterm485 prompts you to run SBE Data Processing’s Data Conversion module if desired. Data Conversion converts the .hex (raw data) file to a .cnv file, which can then be processed by other modules in SBE Data Processing.

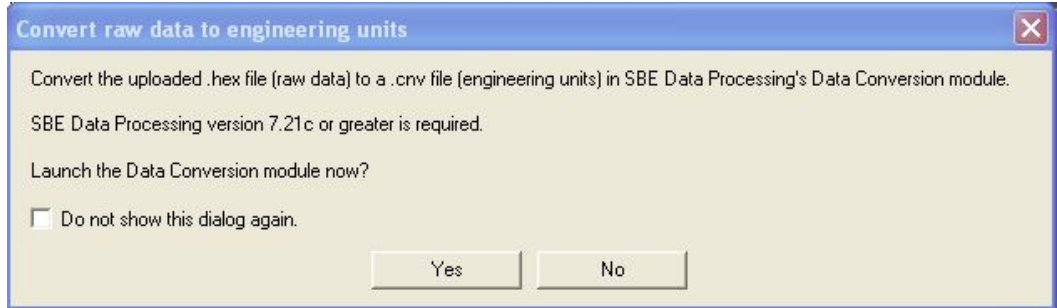

- A. If you click Yes, Seaterm485 opens SBE Data Processing’s Data Conversion module, and fills in the appropriate instrument configuration (.xmlcon) file and data (.hex) file on the File Setup tab.

Location to store all setup information. Default is directory with SeatermV2 application data, when Data Conversion is launched from Seaterm485.

Instrument configuration (.xmlcon) file location, which is created by Seaterm485, and contains MicroCAT’s calibration coefficients (see dialog box below).

Directory and file name for raw data (.hex) file created by Seaterm485 from uploaded data.

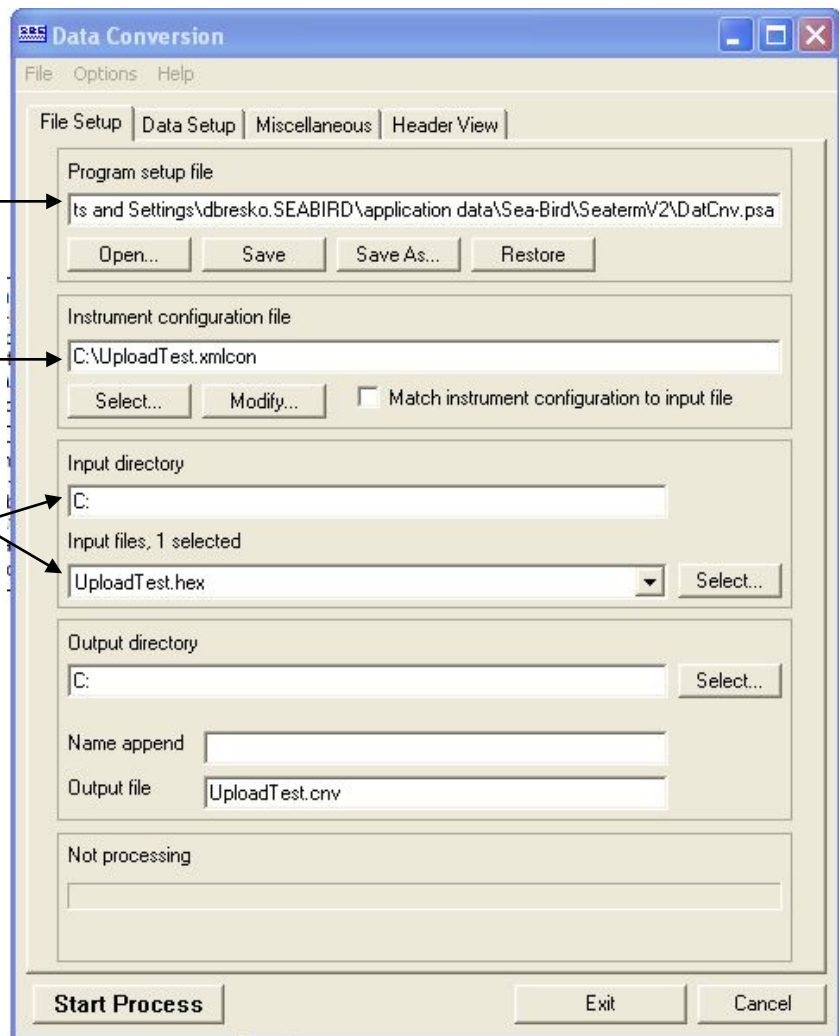

The Configuration dialog box (which appears if you click *Modify* on the File Setup tab) looks like this:

The screenshot shows the 'Configuration for the SBE 37 Microcat' dialog box. It includes the following elements and callouts:

- Configuration file opened:** UploadTest.xmlcon
- Sample interval seconds:** 10. Callout: Time between scans. Must agree with MicroCAT setup (#iiSampleInterval=); see reply from #iiGetCD or #iiDS.
- Sensors:**
  - Pressure sensor
  - Oxygen sensor. Callout: Indicates whether MicroCAT includes integrated dissolved oxygen sensor (37-SMP-IDO, SIP-IDO, or IMP-IDO only).
- Deployment pressure dbar:** 100. Callout: Indicates if MicroCAT includes optional pressure sensor. If no pressure sensor included, deployment pressure is used to calculate conductivity (and derived variables such as salinity and sound velocity). Value shown is based on #iiReferencePressure= that was programmed into MicroCAT; you can change this value in .xmlcon file, if you have updated deployment depth information.
- Deployment latitude:** 0. Callout: Latitude is used to calculate local gravity (to calculate salt water depth). If enabled, software uses input latitude in calculation. If disabled, software uses Latitude on Miscellaneous tab of Data Conversion. Enter latitude for your deployment.
- Use deployment latitude in depth calculations:**
- Sensor Table:**

Channel	Sensor
1. Count	Temperature
2. Frequency	Conductivity

  - Callout: Double click on sensor to view and/or modify calibration coefficients, which are based on calibration coefficients that were programmed into MicroCAT.

Buttons at the bottom: Report..., Help..., Exit, Cancel, Modify..., Save As..., Save, Open..., New.

The settings in the .xmlcon file created by Seaterm485 are based on the setup of the MicroCAT.

- Review the deployment latitude, and modify as needed.
- If your MicroCAT does not have a pressure sensor, review the deployment pressure, and modify as needed.

Click Save if you made any changes, and then click Exit.

B. Click on the Data Setup tab.

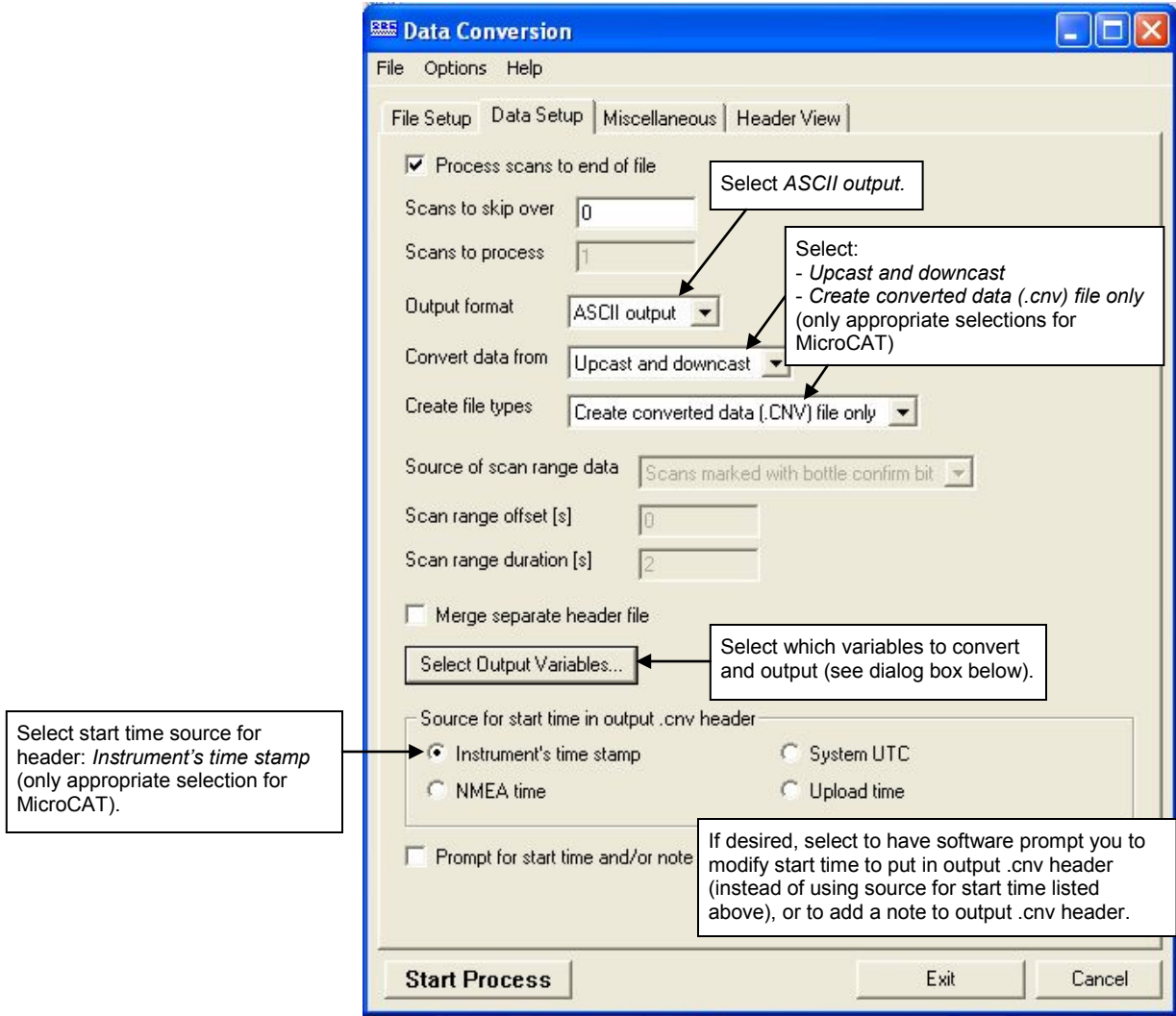

The Select Output Variables dialog box (which appears when you click *Select Output Variables* on the Data Setup tab) looks like this:

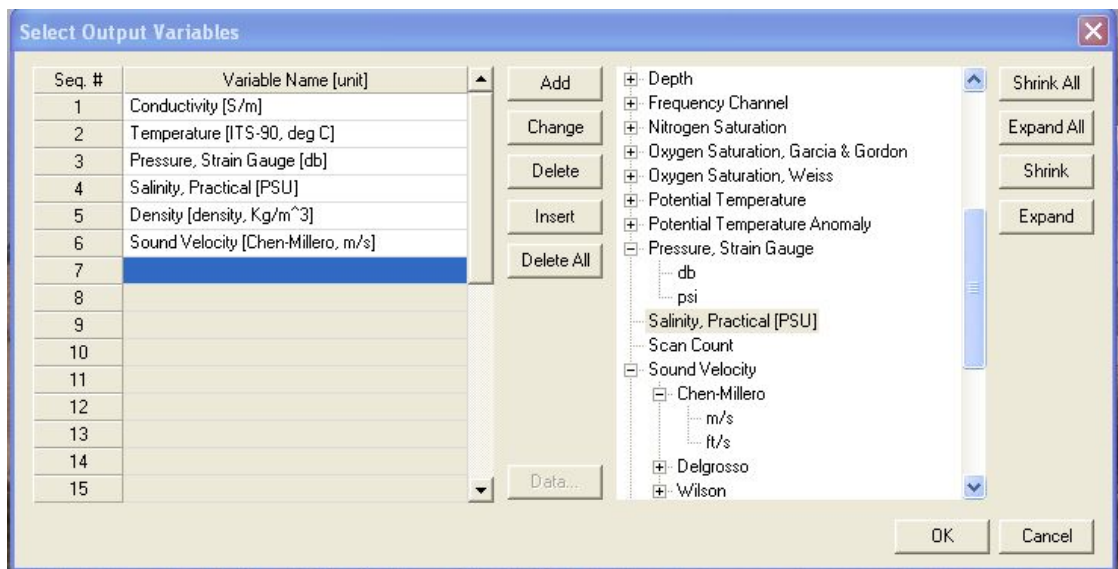

Select Temperature, Conductivity, and Pressure (optional), as well as desired derived variables such as salinity, sound velocity, etc. Click OK.

C. At the bottom of the Data Conversion dialog box, click Start Process to convert the .hex file to a .cnv file.

10. Once the data is converted to a .cnv file, use the other SBE Data Processing modules as desired:

- Derive module - Calculate additional derived variables.
- Sea Plot module - Plot data.

**Notes:**

To prepare for re-deployment:

1. After all data has been uploaded, send **#iiInitLogging**. If this command is not sent, new data will be stored after the last recorded sample, preventing use of the entire memory capacity.

2. Do *one* of the following:

- Send **PwrOff** to put the MicroCAT in quiescent (sleep) state until ready to redeploy. The quiescent current is only 30 microAmps, so the batteries can be left in place without significant loss of capacity.
- Use **#iiStartNow** to begin logging immediately.
- Set a date and time for logging to start using **#iiStartDateTime=** and **#iiStartLater**.



# Section 5: Routine Maintenance and Calibration

This section reviews corrosion precautions, connector mating and maintenance, conductivity cell cleaning and storage, plumbing maintenance, plastic housing handling instructions, replacement of batteries, pressure sensor maintenance, replacement of AF24173 Anti-Foulant Devices, and sensor calibration. The accuracy of the MicroCAT is sustained by the care and calibration of the sensors and by establishing proper handling practices.

---

## Corrosion Precautions

Rinse the MicroCAT with fresh water after use and prior to storage.

All exposed metal is titanium; other materials are plastic. No corrosion precautions are required, but avoid direct electrical connection of the MicroCAT housing to mooring or other dissimilar metal hardware.

---

## Connector Mating and Maintenance

**Note:**

See *Application Note 57: Connector Care and Cable Installation*.

Clean and inspect the connectors, cable, and dummy plug before every deployment and as part of your yearly equipment maintenance. Inspect connectors that are unmated for signs of corrosion product around the pins, and for cuts, nicks or other flaws that may compromise the seal.

**CAUTION:**

**Do not use WD-40** or other petroleum-based lubricants, as they will damage the connectors.

When remating:

1. Lightly lubricate the inside of the dummy plug/cable connector with silicone grease (DC-4 or equivalent).
2. **Standard Connector** - Install the plug/cable connector, aligning the raised bump on the side of the plug/cable connector with the large pin (pin 1 - ground) on the MicroCAT. Remove any trapped air by *burping* or gently squeezing the plug/connector near the top and moving your fingers toward the end cap. **OR**  
**MCBH Connector** – Install the plug/cable connector, aligning the pins.
3. Place the locking sleeve over the plug/cable connector. Tighten the locking sleeve finger tight only. **Do not overtighten the locking sleeve and do not use a wrench or pliers.**

Verify that a cable or dummy plug is installed on the MicroCAT before deployment.

## Conductivity Cell Maintenance

### CAUTIONS:

- **Do not put a brush or any object inside the conductivity cell to clean it.** Touching and bending the electrodes can change the calibration. Large bends and movement of the electrodes can damage the cell.
- **Do not store the MicroCAT with water in the conductivity cell.** Freezing temperatures (for example, in Arctic environments or during air shipment) can break the conductivity cell if it is full of water.

The MicroCAT's conductivity cell is shipped dry to prevent freezing in shipping. Refer to *Application Note 2D: Instructions for Care and Cleaning of Conductivity Cells* for conductivity cell cleaning procedures and cleaning materials.

- The Active Use (after each cast) section of the application note is not applicable to the MicroCAT, which is intended for use as a moored instrument.

To rinse or fill the conductivity cell and pump exhaust plumbing:

- Place Tygon tubing in the end of the anti-foulant device cap on the conductivity cell.
- Hold or clamp the MicroCAT with the intake and exhaust up, so that the plumbing in a U-shape.
- Pour the water or solution through the Tygon, conductivity cell, and pump exhaust plumbing with a syringe or wash bottle.

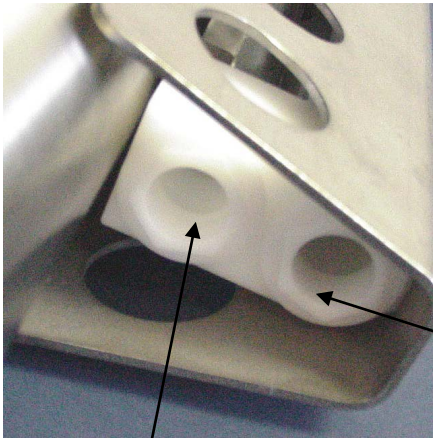

Anti-foulant device cap for conductivity cell intake

Anti-foulant device cap for pump exhaust plumbing

## Plumbing Maintenance



Before each deployment, clean the bleed hole with 0.4 mm diameter wire, 13 mm long (0.016 inch diameter wire, 0.5 inches long) (you can use #26 AWG wire), and blow through it to ensure it is open. A clogged bleed hole can trap air, preventing the pump from functioning properly; this will affect the data quality.

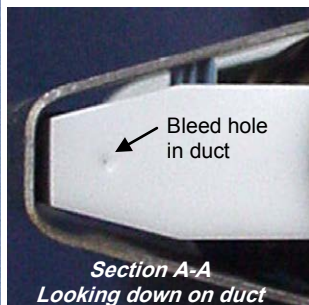

## Handling Instructions for Plastic *ShallowCAT* Option



See detail below

Hex screw securing battery / connector end cap (one each side)



Detail - Battery/connector end cap

The MicroCAT's standard 7000-meter titanium housing offers the best durability with a modest amount of care. The *ShallowCAT* option, substitution of a 250-meter plastic housing, saves money and weight. However, more care and caution in handling is required. To get the same excellent performance and longevity for the plastic-housing version:

- The MicroCAT's battery end cap is retained by two screws through the side of the housing. The screw holes are close to the end of the housing. Particularly in a cold environment, where plastic is more brittle, the potential for developing a crack around the screw hole(s) is greater for the plastic housing than for the titanium housing. Observe the following precautions –
  - When removing the end cap (to replace the batteries and/or to access the electronics), be careful to avoid any impact in this area of the housing.
  - When reinstalling the end cap, do not use excess torque on the screws. Sea-Bird recommends tightening the screws to 15 inch-lbs. Alternatively, tighten the screws finger-tight, and then turn each screw an additional 45 degrees.
- A plastic housing is more susceptible to scratches than a titanium housing. Do not use screwdrivers or other metal tools to pry off the end cap.
  - Of primary concern are scratches on O-ring mating and sealing surfaces. Take extra precaution to avoid a scraping contact with these surfaces when replacing batteries and/or re-seating the end cap.
  - Also take care to keep the O-ring lubricated surfaces clean – avoid trapping any sand or fine grit that can scratch the critical sealing surfaces. If the O-ring lubricant does accumulate any material or grit that can cause a leak or make a scratch, it must be carefully cleaned and replaced with fresh, clean lubricant (Parker Super O Lube).
  - Shallow, external scratches are cosmetic only, and will not affect the performance of the MicroCAT. However, deep external scratches can become points of weakness for deep deployments or fracture from impact during very cold weather.
- If you remove the screws securing the conductivity cell guard to the housing (not typically done by the customer), follow the same precautions as described above for removing and replacing the battery end cap.

See *Battery Installation* in *Section 3: Preparing MicroCAT for Deployment* and *Appendix II: Electronics Disassembly / Reassembly* for detailed step-by-step procedures for removing the MicroCAT's end cap.

## Replacing Batteries

### Notes:

- For details and photos, see *Installing Batteries* in *Section 3: Preparing MicroCAT for Deployment*.
- Battery pack cover plate color may vary.
- Batteries must be removed before returning the MicroCAT to Sea-Bird. Do not return used batteries to Sea-Bird when shipping the MicroCAT for repair.

1. Remove the 2 screws holding the modem end cap to the MicroCAT housing, and remove the end cap.
2. Loosen the captured screw holding the battery pack in the housing, and remove the battery pack from the housing.
3. Place the handle in an upright position. Unscrew the red cover plate from the top of the battery pack assembly.
4. Roll the 2 O-rings on the outside of the pack out of their grooves.
5. Remove the existing batteries. Install new batteries, positive end (+) first.
6. Roll the O-rings into place in the grooves on the side of the battery pack.
7. Place the handle in an upright position. Reinstall the battery pack cover plate.
8. Replace the battery pack assembly in the housing, and secure the assembly with the captured screw. Plug in the Molex connector, and reinstall the MicroCAT end cap.

## Pressure Sensor (optional) Maintenance

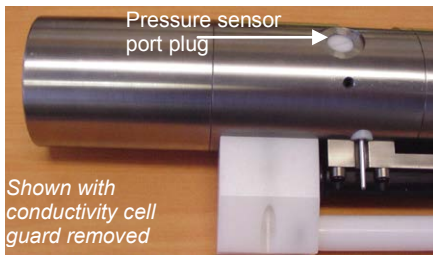

The pressure port plug has a small vent hole to allow hydrostatic pressure to be transmitted to the pressure sensor inside the instrument, while providing protection for the pressure sensor, keeping most particles and debris out of the pressure port.

Periodically (approximately once a year) inspect the pressure port to remove any particles, debris, etc:

1. Unscrew the pressure port plug from the pressure port.
2. Rinse the pressure port with warm, de-ionized water to remove any particles, debris, etc.
3. Replace the pressure port plug.

### CAUTION:

**Do not put a brush or any object in the pressure port.** Doing so may damage or break the pressure sensor.

## Replacing Anti-Foulant Devices – Mechanical Design Change

The AF24173 Anti-Foulant Devices are installed in an anti-foulant device cup that attaches to the conductivity cell intake and the pump exhaust. Details are provided below on replacing the AF24173 Anti-Foulant Devices. This page provides the mechanical details for the SBE 37-SMP MicroCAT. The following page, which was developed for a MicroCAT that does not include an integral pump, provides the precautions and handling details.

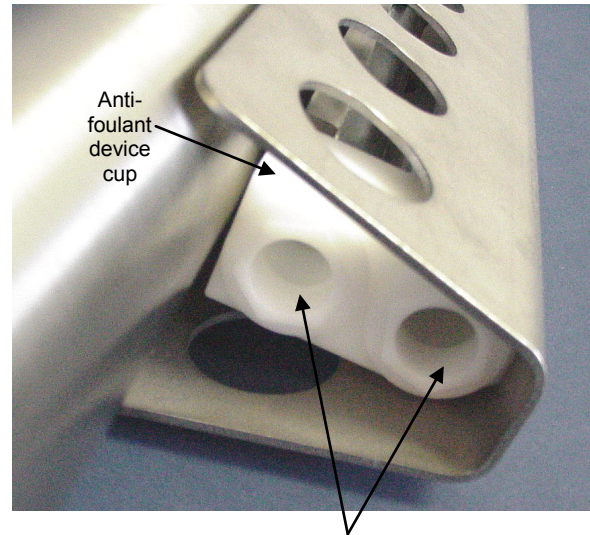
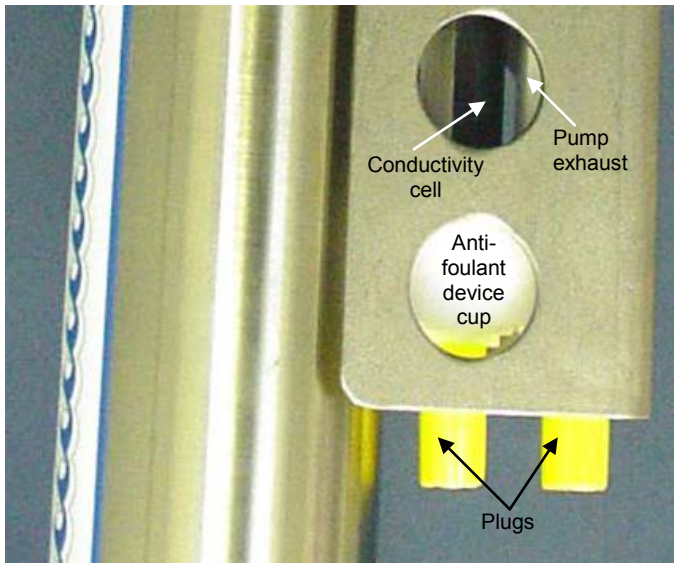

Anti-foulant device caps  
(plugs removed)

### CAUTION:

The anti-foulant device cup is attached to the guard and connected with tubing to the cell. **Removing the guard without disconnecting the cup from the guard will break the cell.** If the guard must be removed:

1. Remove the two screws connecting the anti-foulant device cup to the guard.
2. Remove the four Phillips-head screws connecting the guard to the housing and sensor end cap.
3. Gently lift the guard away.

## Replacing Anti-Foulant Devices (SBE 37-SI, SM, IM)



AF24173  
Anti-Foulant  
Device

The MicroCAT has an anti-foulant device cup and cap on each end of the cell. New MicroCATs are shipped with an Anti-Foulant Device and a protective plug pre-installed in each cup.

### **WARNING!**

**AF24173 Anti-Foulant Devices contain bis(tributyltin) oxide. Handle the devices only with rubber or latex gloves. Wear eye protection. Wash with soap and water after handling.**

**Read precautionary information on product label (see Appendix IV) before proceeding.**

**It is a violation of US Federal Law to use this product in a manner inconsistent with its labeling.**

**Wearing rubber or latex gloves**, follow this procedure to replace each Anti-Foulant Device (two):

1. Remove the protective plug from the anti-foulant device cup;
2. Unscrew the cap with a  $\frac{5}{8}$ -inch socket wrench;
3. Remove the old Anti-Foulant Device. If the old device is difficult to remove:
  - Use needle-nose pliers and carefully break up material;
  - If necessary, remove the guard to provide easier access.

Place the new Anti-Foulant Device in the cup;

4. Rethread the cap onto the cup. Do not over tighten;
5. If the MicroCAT is to be stored, reinstall the protective plug. **Note that the plugs must be removed prior to deployment or pressurization.** If the plugs are left in place during deployment, the cell will not register conductivity. If left in place during pressurization, the cell may be destroyed.

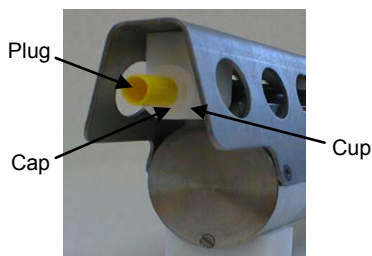
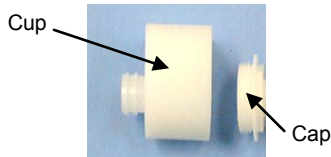

### **CAUTION:**

Anti-foulant device cups are attached to the guard and connected with tubing to the cell. **Removing the guard without disconnecting the cups from the guard will break the cell.** If the guard must be removed:

1. Remove the two screws connecting each anti-foulant device cup to the guard.
2. Remove the four Phillips-head screws connecting the guard to the housing and sensor end cap.
3. Gently lift the guard away.

## Sensor Calibration

### Notes:

- Batteries must be removed before returning the MicroCAT to Sea-Bird. Do not return used batteries to Sea-Bird when shipping the MicroCAT for recalibration or repair.
- Please remove AF24173 Anti-Foulant Devices from the anti-foulant device cup before returning the MicroCAT to Sea-Bird. Store them for future use. See *Replacing Anti-Foulant Devices* for removal procedure.

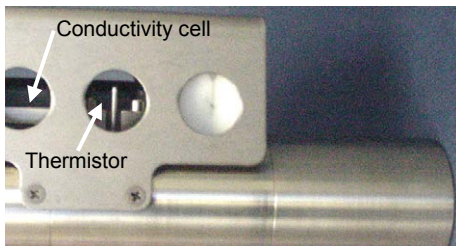

Sea-Bird sensors are calibrated by subjecting them to known physical conditions and measuring the sensor responses. Coefficients are then computed which may be used with appropriate algorithms to obtain engineering units. The conductivity, temperature, and optional pressure sensors on the MicroCAT are supplied fully calibrated, with coefficients printed on their respective Calibration Certificates (see back of manual). These coefficients have been stored in the MicroCAT's EEPROM.

We recommend that MicroCATs be returned to Sea-Bird for calibration.

### Conductivity Sensor Calibration

The conductivity sensor incorporates a fixed precision resistor in parallel with the cell. When the cell is dry and in air, the sensor's electrical circuitry outputs a frequency representative of the fixed resistor. This frequency is recorded on the Calibration Certificate and should remain stable (within 1 Hz) over time.

The primary mechanism for calibration drift in conductivity sensors is the fouling of the cell by chemical or biological deposits. Fouling changes the cell geometry, resulting in a shift in cell constant.

Accordingly, the most important determinant of long-term sensor accuracy is the cleanliness of the cell. We recommend that the conductivity sensors be calibrated before and after deployment, but particularly when the cell has been exposed to contamination by oil slicks or biological material.

### Temperature Sensor Calibration

The primary source of temperature sensor calibration drift is the aging of the thermistor element. Sensor drift will usually be a few thousandths of a degree during the first year, and less in subsequent intervals. Sensor drift is not substantially dependent upon the environmental conditions of use, and — unlike platinum or copper elements — the thermistor is insensitive to shock.

## Pressure Sensor (optional) Calibration

The optional strain-gauge pressure sensor is a mechanical diaphragm type, with an initial static error band of 0.05%. Consequently, the sensor is capable of meeting the MicroCAT's 0.10% error specification with some allowance for aging and ambient-temperature induced drift.

Pressure sensors show most of their error as a linear offset from zero. A technique is provided below for making small corrections to the pressure sensor calibration using the *offset* (**#iiPOffset=**) calibration coefficient term by comparing MicroCAT pressure output to readings from a barometer.

Allow the MicroCAT to equilibrate in a reasonably constant temperature environment for at least 5 hours before starting. Pressure sensors exhibit a transient change in their output in response to changes in their environmental temperature. Sea-Bird instruments are constructed to minimize this by thermally decoupling the sensor from the body of the instrument. However, there is still some residual effect; allowing the MicroCAT to equilibrate before starting will provide the most accurate calibration correction.

### Note:

The MicroCAT's pressure sensor is an absolute sensor, so its **raw** output (**#iiOutputFormat=0**) includes the effect of atmospheric pressure (14.7 psi). As shown on the Calibration Sheet, Sea-Bird's calibration (and resulting calibration coefficients) is in terms of psia. However, when outputting pressure in **engineering units**, the MicroCAT outputs pressure relative to the ocean surface (i.e., at the surface the output pressure is 0 decibars). The MicroCAT uses the following equation to convert psia to decibars:

$$\text{Pressure (db)} = [\text{pressure (psia)} - 14.7] * 0.689476$$

1. Place the MicroCAT in the orientation it will have when deployed.
2. In Seaterm485:
  - A. Set the pressure offset to 0.0 (**#iiPOffset=0**).
  - B. Set the output format to converted decimal (**#iiOutputFormat=1**), so the pressure output will be in decibars.
  - C. Send **#iiTSn:100** to take 100 samples and transmit data.
3. Compare the MicroCAT output to the reading from a good barometer at the same elevation as the MicroCAT's pressure sensor port. Calculate *offset* = barometer reading – MicroCAT reading
4. Enter the calculated offset (positive or negative) in the MicroCAT's EEPROM, using **#iiPOffset=** in Seaterm485.

### Offset Correction Example

Absolute pressure measured by a barometer is 1010.50 mbar. Pressure displayed from MicroCAT is -2.5 dbars.

Convert barometer reading to dbars using the relationship: mbar \* 0.01 = dbar

Barometer reading = 1010.50 mbar \* 0.01 = 10.1050 dbar

The MicroCAT's internal calculations output gage pressure, using an assumed value of 14.7 psi for atmospheric pressure. Convert MicroCAT reading from gage to absolute by adding 14.7 psia to the MicroCAT's output:

-2.5 dbars + (14.7 psi \* 0.689476 dbar/psia) = -2.5 + 10.13 = 7.635 dbars

Offset = 10.1050 – 7.635 = + 2.47 dbars

Enter offset in MicroCAT.

For demanding applications, or where the sensor's air ambient pressure response has changed significantly, calibration using a dead-weight generator is recommended. The pressure sensor port uses a <sup>7</sup>/<sub>16</sub>-20 straight thread for mechanical connection to the pressure source. Use a fitting that has an O-ring tapered seal, such as Swagelok-200-1-4ST, which conforms to MS16142 boss.



# Section 6: Troubleshooting

This section reviews common problems in operating the MicroCAT, and provides the most common causes and solutions.

---

## Problem 1: Unable to Communicate with MicroCAT

If `#iiOutputExecutedTag=N`, the `S>` prompt indicates that communications between the MicroCAT and computer have been established. Before proceeding with troubleshooting, attempt to establish communications again by selecting *Connect* in the Communications menu in Seaterm485, sending two `@` characters, or pressing any key several times.

**Cause/Solution 1:** The I/O cable connection may be loose. Check the cabling between the MicroCAT and computer for a loose connection.

**Cause/Solution 2:** The instrument communication settings may not have been entered correctly in Seaterm485. Verify the settings in the Configure Communications dialog box (Communications menu -> *Configure*). The settings should match those on the instrument Configuration Sheet.

**Cause/Solution 3:** The I/O cable between the MicroCAT and computer may not be the correct one.

---

## Problem 2: No Data Recorded

**Cause/Solution 1:** The memory may be full; once the memory is full, no further data will be recorded. Verify that the memory is not full using `#iiGetSD` or `#iiDS` (*free = 0* or *1* if memory is full). Sea-Bird recommends that you upload all previous data before beginning another deployment. Once the data is uploaded, send `#iiInitLogging` to reset the memory. After the memory is reset, `#iiGetSD` or `#iiDS` will show *samples = 0*.

---

## Problem 3: Unreasonable T, C, or P Data

The symptom of this problem is a data file that contains unreasonable values (for example, values that are outside the expected range of the data).

**Cause/Solution 1:** A data file with unreasonable (i.e., out of the expected range) values for temperature, conductivity, or pressure may be caused by incorrect calibration coefficients in the MicroCAT. Send `#iiGetCC` to verify the calibration coefficients in the MicroCAT match the instrument Calibration Certificates. Note that calibration coefficients do not affect the raw data stored in MicroCAT memory.

- If you have not yet overwritten the memory with new data, you can correct the coefficients and then upload the data again.
- If you have overwritten the memory with new data, you can manually correct the coefficients in the `.xmlcon` configuration file, and then reprocess the data in SBE Data Processing's Data Conversion module.

**Cause/Solution 2:** Minimal changes in **conductivity** are an indication that the pump flow is not correct. Poor flushing can have several causes:

- Air in the plumbing may be preventing the pump from priming. This can result from:
  - A clogged air bleed hole; clean the air bleed hole (see *Plumbing Maintenance* in *Section 5: Routine Maintenance and Calibration*).
  - Incorrect orientation for a shallow deployment in a location with breaking waves; see *Optimizing Data Quality / Deployment Orientation* in *Section 4: Deploying and Operating MicroCAT*.
- The pump may be clogged by sediment. Using a wash bottle, flush the plumbing to attempt to dislodge the sediment. If the sediment is impacted and you cannot flush it, return the MicroCAT to Sea-Bird for servicing. To minimize ingestion of sediment for future deployments, see *Optimizing Data Quality / Deployment Orientation* in *Section 4: Deploying and Operating MicroCAT*.
- The pump may not be turning on before each sample, if **#iiMinCondFreq=** is set too high. See *Command Descriptions* in *Section 4: Deploying and Operating MicroCAT* for details.

---

## Problem 4: Salinity Spikes

Salinity is a function of conductivity, temperature, and pressure, and must be calculated from C, T, and P measurements made on the same parcel of water. Salinity is calculated and output by the 37-SMP if **#iiOutputSal=Y**. Alternatively, salinity can be calculated in SBE Data Processing's Data Conversion module from the data uploaded from memory (.hex file) or in SBE Data Processing's Derive module from the converted (.cnv) file.

[*Background information:* Salinity spikes in **profiling** (i.e., moving, fast sampling) instruments typically result from misalignment of the temperature and conductivity measurements in conditions with sharp gradients. This misalignment is often caused by differences in response times for the temperature and conductivity sensors, and can be corrected for in post-processing if the T and C response times are known.]

In **moored**, pumped instruments such as the 37-SMP MicroCAT, the pump flushes the conductivity cell at a faster rate than the environment changes, so the T and C measurements stay closely synchronized with the environment (i.e., even slow or varying response times are not significant factors in the salinity calculation). More typical causes of salinity spikes in a moored 37-SMP include:

**Cause/Solution 1:** Severe external bio-fouling can restrict flow through the conductivity cell to such an extent that the conductivity measurement is significantly delayed from the temperature measurement.

**Cause/Solution 2:** For a MicroCAT moored at shallow depth, differential solar heating can cause the actual temperature inside the conductivity cell to differ from the temperature measured by the thermistor. Salinity spikes associated mainly with daytime measurements during sunny conditions may be caused by this phenomenon.

**Cause/Solution 3:** For a MicroCAT moored at shallow depth, air bubbles from breaking waves or spontaneous formation in supersaturated conditions can cause the conductivity cell to read low of correct.

# Glossary

**Battery pack** – 12 AA lithium batteries in a battery holder that connects 2 cells in series and each series string in parallel. Battery pack uses:

- Saft LS 14500, AA, 3.6 V and 2.45 Amp-hours each (www.saftbatteries.com) (**recommended**),
- Tadiran TL-4903, AA, 3.6 V and 2.4 Amp-hours each (www.tadiran.com), or
- Electrochem 3B0064/BCX85, AA, 3.9 V and 2.0 Amp-hours each (www.electrochemsolutions.com)

**Fouling** - Biological growth in the conductivity cell during deployment.

**MicroCAT (SBE 37)** – High-accuracy conductivity, temperature, and optional pressure Recorder/Sensor. A number of models are available:

- 37-IM (**I**nductive **M**odem, internal battery and memory)
- 37-IMP (**I**nductive **M**odem, internal battery and memory, integral **P**ump)
- 37-IMP-IDO (**I**nductive **M**odem, internal battery and memory, integral **P**ump, **I**ntegral **D**issolved **O**xygen)
- 37-SM (**S**erial interface, internal battery and **M**emory)
- 37-SMP (**S**erial interface, internal battery and **M**emory, integral **P**ump)
- 37-SMP-IDO (**S**erial interface, internal battery and **M**emory, integral **P**ump, **I**ntegral **D**issolved **O**xygen)
- 37-SI (**S**erial **I**nterface, memory, no internal battery) \*
- 37-SIP (**S**erial **I**nterface, integral **P**ump, memory, no internal battery) \*
- 37-SIP-IDO (**S**erial **I**nterface, integral **P**ump, **I**ntegral **D**issolved **O**xygen, memory, no internal battery)

The SM, SMP, SMP-IDO, SI, SIP, and SIP-IDO are available with RS-232 (standard) or RS-485 (optional) interface.

\* Note: Version 3.0 and later of the 37-SI and 37-SIP include memory; earlier versions did not include memory.

**PCB** – Printed Circuit Board.

**Note:**

All Sea-Bird software listed was designed to work with a computer running Windows 2000/XP. Extensive testing has not shown any compatibility problems when using the software with a computer running Windows Vista or Windows 7 (32-bit).

**SBE Data Processing** - Sea-Bird's Win 2000/XP data processing software, which calculates and plots temperature, conductivity, and optional pressure, and derives variables such as salinity, sound velocity, density, depth, etc.

**Scan** - One data sample containing temperature, conductivity, optional pressure, and date and time, as well as optional derived variables (salinity, sound velocity, depth, density).

**SEASOFT V2**– Sea-Bird's complete Win 2000/XP software package, which includes software for communication, real-time data acquisition, and data analysis and display. SEASOFT V2 includes *Seaterm V2* and *SBE Data Processing*.

**SeatermV2** – Win 2000/XP terminal program *launcher*, which launches the appropriate terminal program for the selected instrument (Seaterm485 for this MicroCAT).

**Seaterm485** – Win 2000/XP terminal program used with Sea-Bird instruments that communicate via an RS-485 interface, and that were developed or redesigned in 2006 and later. The common feature of these instruments is the ability to output data in XML. The current list of instruments supported by Seaterm485 includes: SBE 16*plus* V2 (RS-485 interface, version 2 or later firmware), SBE 37-SM / SMP / SI / SIP (all RS-485 interface, all version 3 or later firmware), and SBE 37-SMP-IDO / SIP-IDO (all RS-485 interface).

**Super O-Lube** – Silicone lubricant used to lubricate O-rings and O-ring mating surfaces. Super O-Lube can be ordered from Sea-Bird, but should also be available locally from distributors. Super O-Lube is manufactured by Parker Hannifin ([www.parker.com/ead/cm2.asp?cmid=3956](http://www.parker.com/ead/cm2.asp?cmid=3956))

**TCXO** - Temperature Compensated Crystal Oscillator.

**Triton X100** - Reagent grade non-ionic surfactant (detergent), used for cleaning the conductivity cell. Triton can be ordered from Sea-Bird, but should also be available locally from chemical supply or laboratory products companies. Triton is manufactured by Mallinckrodt Baker ([www.mallbaker.com/changecountry.asp?back=/Default.asp](http://www.mallbaker.com/changecountry.asp?back=/Default.asp)).

# Appendix I: Functional Description

## Sensors

The MicroCAT embodies the same sensor elements (3-electrode, 2-terminal, borosilicate glass cell, and pressure-protected thermistor) previously employed in our modular SBE 3 and SBE 4 sensors and in the SEACAT and SEACAT *plus* family.

**Note:**

Pressure ranges are expressed in meters of deployment depth capability.

The MicroCAT's optional strain-gauge pressure sensor is available in the following pressure ranges: 20, 100, 350, 600, 1000, 2000, 3500, and 7000 meters. Compensation of the temperature influence on pressure offset and scale is performed by the MicroCAT's CPU.

---

## Sensor Interface

Temperature is acquired by applying an AC excitation to a hermetically sealed VISHAY reference resistor and an ultra-stable aged thermistor with a drift rate of less than 0.002°C per year. A 24-bit A/D converter digitizes the outputs of the reference resistor and thermistor (and optional pressure sensor).

AC excitation and ratiometric comparison using a common processing channel avoids errors caused by parasitic thermocouples, offset voltages, leakage currents, and reference errors.

Conductivity is acquired using an ultra-precision Wien-Bridge oscillator to generate a frequency output in response to changes in conductivity.

---

## Real-Time Clock

To minimize power and improve clock accuracy, a temperature-compensated crystal oscillator (TCXO) is used as the real-time-clock frequency source. The TCXO is accurate to  $\pm 1$  minute per year (0 °C to 40 °C).

# Appendix II: Electronics Disassembly/Reassembly

## Disassembly

### CAUTION:

See *Section 5: Routine Maintenance and Calibration* for handling instructions for the plastic *ShallowCAT* housing.

1. Remove the end cap and battery pack following instructions in *Section 3: Preparing MicroCAT for Deployment*. **Do not remove the titanium guard!**
2. The electronics are on a sandwich of three rectangular PCBs. These PCBs are assembled to a bulkhead that can be seen at the bottom of the battery compartment. To remove the PCB assembly:
  - A. Use a long screwdriver (#1 screwdriver) to remove the Phillips-head screw at the bottom of the battery compartment. The Phillips-head screw is a 198mm (7.8 in.) threaded rod with Phillips-head.
  - B. Pull out the PCB assembly using the PVC pylon (post with Molex connector). The assembly will pull away from the 10-position edge connector used to connect to the sensors.

## Reassembly

### Note:

If the rod will not tighten, the PCBs have not fully mated or are mated in reverse.

### Note:

Before delivery, a desiccant package is inserted in the housing and the electronics chamber is filled with dry Argon gas. These measures help prevent condensation. To ensure proper functioning:

1. Install a new desiccant bag each time you open the electronics chamber. If a new bag is not available, see *Application Note 71: Desiccant Use and Regeneration (drying)*.
2. If possible, dry gas backfill each time you open the housing. If you cannot, wait at least 24 hours before redeploying, to allow the desiccant to remove any moisture from the housing.

Note that opening the battery compartment does not affect desiccation of the electronics.

1. Sight down into the MicroCAT housing to find the hole into which the Phillips-head screw threads. The hole is at the bottom of the housing, next to the edge connector. The small-diameter brass sleeve between two of the PCBs guides the screw into the hole. Align this sleeve with the hole.
2. Guide the PCB assembly into the housing and push the assembly until the edge connector is fully inserted. A gentle resistance can be felt during the last 3 mm ( $1/8$  inch) of insertion as the PCB assembly mates to the edge connector.
3. Drop the Phillips-head screw into the hole and tighten gently.
4. If it is difficult to align the cards, obtain a 305mm (12 in.) length of 6-32 threaded rod.
  - A. Thread the end of this rod into the hole at the bottom of the housing (next to the edge connector).
  - B. Slide the PCB assembly's small diameter brass sleeve down the rod. The rod will help guide the assembly into the proper position.
  - C. Push the assembly until the edge connector is fully inserted. After the PCB assembly has been fully inserted, remove the rod.
  - D. Drop the Phillips-head screw into the hole and tighten gently.
5. Reinstall the battery pack and end cap following instructions in *Section 3: Preparing MicroCAT for Deployment*.

# Appendix III: Command Summary

**Note:**  
See *Command Descriptions* in Section 4: *Deploying and Operating MicroCAT* for detailed information and examples.

CATEGORY	COMMAND	DESCRIPTION
MicroCAT ID Commands	ID?	Get MicroCAT ID (ID = ii, where ii= 0-99).
	*ID=ii	Set MicroCAT ID to ii, where ii= 0-99. Must be sent twice, because computer responds by requesting verification.
Global	DateTime= mmddyyyyhhmmss	Set clock month, day, year, hour, minute, second.
	GData	Command <b>all</b> MicroCATs to run pump for 1.0 second and get 1 sample. MicroCATs hold data in buffer until receiving <b>Dataii</b> . Data is not stored in FLASH memory.
	PwrOff	Enter quiescent (sleep) state. Main power turned off, but data logging and memory retention unaffected.
Get Data	Dataii	Get data obtained with <b>GData</b> from MicroCAT with ID=ii.
Status	#iiGetCD	Get and display configuration data.
	#iiGetSD	Get and display status data.
	#iiGetCC	Get and display calibration coefficients.
	#iiGetEC	Get and display event counter data.
	#iiResetEC	Reset event counter.
	#iiGetHD	Get and display hardware data.
	#iiDS or !iiDS #iiDC	Get and display status and configuration data. Get and display calibration coefficients.
General Setup	#iiBaudRate=x	x= baud rate (600, 1200, 2400, 4800, 9600, 19200, 38400, 57600, or 115200). Default 9600. Must be sent twice.
	#iiRxDelay=x	x= delay after MicroCAT receives command until transmitter is enabled (1 – 500 msec). Default 25 msec.
	#iiTxDelay=x	x= delay after MicroCAT transmits reply until transmitter is disabled (1 – 500 msec). Default 25 msec
	#iiDateTime= mmddyyyyhhmmss	Set clock month, day, year, hour, minute, second.
	#iiOutputExecutedTag =x	x=Y: Display XML Executing and Executed tags. x=N: Do not.
	#iiReferencePressure =x	x= reference pressure (gauge) in decibars (used for conductivity calculation when MicroCAT does not have pressure sensor).
Pump Setup	#iiMinCondFreq=	x= minimum conductivity frequency (Hz) to enable pump turn-on for autonomous or serial line sync mode sampling.
	#iiPumpOn	Turn pump on for testing or to remove sediment.
	#iiPumpOff	Turn pump off, if turned on with <b>#iiPumpOn</b> .

CATEGORY	COMMAND	DESCRIPTION
Memory Setup	<b>#iiInitLogging</b>	Initialize logging to make entire memory available for recording.
	<b>#iiSampleNumber=x</b>	x= sample number for last sample in memory. <b>#iiSampleNumber=0</b> equivalent to <b>#iiInitLogging</b> .
Output Format Setup	<b>#iiOutputFormat=x</b>	x=0: output raw decimal data. x=1: output converted decimal data x=2: output converted decimal data in XML. x=3: output converted decimal data, alternate format.
	<b>#iiOutputSal=x</b>	x=Y: Calculate and output salinity (psu). x=N: Do not.
	<b>#iiOutputSV=x</b>	x=Y: Calculate and output sound velocity (m/sec). x=N: Do not.
	<b>#iiOutputDepth=x</b>	x=Y: Calculate and output depth (meters). x=N: Do not.
	<b>#iiOutputDensity=x</b>	x=Y: Calculate and output local density. x=N: Do not.
	<b>#iiLatitude=x</b>	x= latitude (degrees) to use in depth calculation.
Autonomous Sampling (Logging)	<b>#iiSampleInterval=x</b>	x= interval (seconds) between samples (6 - 21600). When commanded to start sampling with <b>#iiStartNow</b> or <b>#iiStartLater</b> , MicroCAT runs pump for 1.0 second, takes sample, stores data in FLASH memory, and powers down at x second intervals.
	<b>#iiStartNow</b>	Start logging now.
	<b>#iiStartDateTime=mmddyyyyhmmss</b>	Delayed logging start: month, day, year, hour, minute, second.
	<b>#iiStartLater</b>	Start logging at delayed logging start time.
	<b>#iiStop</b>	Stop logging or stop waiting to start logging. Press Enter key before entering command. Must send <b>#iiStop</b> before uploading data.
Polled Sampling	<b>#iiTS</b>	Run pump for 1.0 second, take sample, store in buffer, output data.
	<b>#iiTSR</b>	Run pump for 1.0 second, take sample, store in buffer, output raw decimal data (regardless of setting for <b>#iiOutputFormat=</b> )
	<b>#iiTSH</b>	Run pump for 1.0 second, take sample, store in buffer (do not output).
	<b>#iiTSS</b>	Run pump for 1.0 second, take sample, store in buffer and in FLASH memory, output data.
	<b>#iiTSn:x</b>	Run pump continuously while taking x samples and outputting data.
	<b>#iiSL</b>	Output last sample stored in buffer.
	<b>#iiSLT</b>	Output last sample stored in buffer, then run pump for 1.0 second, take new sample, and store in buffer (do not output data from new sample).
Serial Line Sync Mode	<b>#iiSyncMode=x</b>	x=Y: Enable serial line sync mode. When a simple pulse (or a single character) is transmitted, MicroCAT wakes up, runs pump for 1.0 second, takes sample, stores data in FLASH memory, transmits data (if <b>#iiTxSyncMode=Y</b> ), and powers down. Disable serial line sync mode by pressing Enter key twice within 3 seconds of sending pulse. x=N: Disable serial line sync mode.
	<b>#iiTxSyncMode=x</b>	x=Y: Transmit real-time data when in serial line sync mode. x=N: Do not.



**Note:**  
**Use Seaterm485's Upload menu to upload data that will be processed by SBE Data Processing.**  
 Manually entering a data upload command does not produce data with the required header information for processing by SBE Data Processing.

CATEGORY	COMMAND	DESCRIPTION
<b>Data Upload</b> (send #iiStop before sending upload command)	#iiGetSamples=b,e	Upload scan <b>b</b> to scan <b>e</b> , in format defined by #iiOutputFormat=.
	#iiDDb,e	Upload scan <b>b</b> to scan <b>e</b> , in alternate converted decimal form (#iiOutputFormat=3) (regardless of setting for #iiOutputFormat=).
<b>Coefficients</b> (F=floating point number; S=string with no spaces)	#iiTCalDate=S	S=Temperature calibration date.
	#iiTA0=F	F=Temperature A0.
	#iiTA1=F	F=Temperature A1.
	#iiTA2=F	F=Temperature A2.
	#iiTA3=F	F=Temperature A3.
	#iiCCalDate=S	S=Conductivity calibration date.
	#iiCG=F	F=Conductivity G.
	#iiCH=F	F=Conductivity H.
	#iiCI=F	F=Conductivity I.
	#iiCJ=F	F=Conductivity J.
	#iiWBOTC=F	F=Conductivity wbotc.
	#iiCTCor=F	F=Conductivity ctcor.
	#iiCPCor=F	F=Conductivity cpcor.
	#iiPCalDate=S	S=Pressure calibration date.
	#iiPA0=F	F=Pressure A0.
	#iiPA1=F	F=Pressure A1.
	#iiPA2=F	F=Pressure A2.
	#iiPTCA0=F	F=Pressure ptca0.
	#iiPTCA1=F	F=Pressure ptca1.
	#iiPTCA2=F	F=Pressure ptca2.
#iiPTCB0=F	F=Pressure ptcb0.	
#iiPTCB1=F	F=Pressure ptcb1.	
#iiPTCB2=F	F=Pressure ptcb2.	
#iiPTempA0=F	F=Pressure temperature a0.	
#iiPTempA1=F	F=Pressure temperature a1.	
#iiPTempA2=F	F=Pressure temperature a2.	
#iiPOffset=F	F=Pressure offset (decibars).	
<b>Hardware Configuration</b>	<i>Factory Settings – do not modify in the field</i>	
	#iiSetPumpInstalled=Y	(only valid setting for 37-SMP)
	#iiSetPressureInstalled=	
	#iiSetMfgDate=	
	#iiSetPcbAssembly1=, #iiSetPcbAssembly2=, #iiSetPcbAssembly3=	

# Appendix IV: AF24173 Anti-Foulant Device

*AF24173 Anti-Foulant Devices supplied for user replacement are supplied in polyethylene bags displaying the following label:*

## AF24173 ANTI-FOULANT DEVICE

FOR USE ONLY IN SEA-BIRD ELECTRONICS' CONDUCTIVITY SENSORS TO CONTROL THE GROWTH OF AQUATIC ORGANISMS WITHIN ELECTRONIC CONDUCTIVITY SENSORS.

### ACTIVE INGREDIENT:

Bis(tributyltin) oxide.....	53.0%
OTHER INGREDIENTS: .....	<u>47.0%</u>
Total.....	100.0%

### DANGER

See the complete label within the Conductivity Instrument Manual for Additional Precautionary Statements and Information on the Handling, Storage, and Disposal of this Product.

Net Contents: Two anti-foulant devices

Sea-Bird Electronics, Inc.  
13431 NE 20<sup>th</sup> Street  
Bellevue, WA 98005

EPA Registration No. 74489-1  
EPA Establishment No. 74489-WA-1

# AF24173 Anti-Foulant Device

FOR USE ONLY IN SEA-BIRD ELECTRONICS' CONDUCTIVITY SENSORS TO CONTROL THE GROWTH OF AQUATIC ORGANISMS WITHIN ELECTRONIC CONDUCTIVITY SENSORS.

**ACTIVE INGREDIENT:**

Bis(tributyltin) oxide.....	53.0%
OTHER INGREDIENTS: .....	47.0%
Total.....	100.0%

**DANGER**

See Precautionary Statements for additional information.

<b>FIRST AID</b>	
If on skin or clothing	<ul style="list-style-type: none"> <li>• Take off contaminated clothing.</li> <li>• Rinse skin immediately with plenty of water for 15-20 minutes.</li> <li>• Call a poison control center or doctor for treatment advice.</li> </ul>
If swallowed	<ul style="list-style-type: none"> <li>• Call poison control center or doctor immediately for treatment advice.</li> <li>• Have person drink several glasses of water.</li> <li>• Do not induce vomiting.</li> <li>• Do not give anything by mouth to an unconscious person.</li> </ul>
If in eyes	<ul style="list-style-type: none"> <li>• Hold eye open and rinse slowly and gently with water for 15-20 minutes.</li> <li>• Remove contact lenses, if present, after the first 5 minutes, then continue rinsing eye.</li> <li>• Call a poison control center or doctor for treatment advice.</li> </ul>
<b>HOT LINE NUMBER</b>	
<b>Note to Physician</b>	Probable mucosal damage may contraindicate the use of gastric lavage.
Have the product container or label with you when calling a poison control center or doctor, or going for treatment. For further information call National Pesticide Telecommunications Network (NPTN) at 1-800-858-7378.	

Net Contents: Two anti-foulant devices

Sea-Bird Electronics, Inc.  
 13431 NE 20<sup>th</sup> Street  
 Bellevue, WA 98005

EPA Registration No. 74489-1  
 EPA Establishment No. 74489-WA-1

## PRECAUTIONARY STATEMENTS

### HAZARD TO HUMANS AND DOMESTIC ANIMALS

#### DANGER

**Corrosive** - Causes irreversible eye damage and skin burns. Harmful if swallowed. Harmful if absorbed through the skin or inhaled. Prolonged or frequently repeated contact may cause allergic reactions in some individuals. Wash thoroughly with soap and water after handling.

#### PERSONAL PROTECTIVE EQUIPMENT

##### USER SAFETY RECOMMENDATIONS

Users should:

- Remove clothing immediately if pesticide gets inside. Then wash thoroughly and put on clean clothing.
- Wear protective gloves (rubber or latex), goggles or other eye protection, and clothing to minimize contact.
- Follow manufacturer's instructions for cleaning and maintaining PPE. If no such instructions for washables, use detergent and hot water. Keep and wash PPE separately from other laundry.
- Wash hands with soap and water before eating, drinking, chewing gum, using tobacco or using the toilet.

#### ENVIRONMENTAL HAZARDS

Do not discharge effluent containing this product into lakes, streams, ponds, estuaries, oceans, or other waters unless in accordance with the requirements of a National Pollutant Discharge Elimination System (NPDES) permit and the permitting authority has been notified in writing prior to discharge. Do not discharge effluent containing this product to sewer systems without previously notifying the local sewage treatment plant authority. For guidance contact your State Water Board or Regional Office of EPA. This material is toxic to fish. Do not contaminate water when cleaning equipment or disposing of equipment washwaters.

#### PHYSICAL OR CHEMICAL HAZARDS

Do not use or store near heat or open flame. Avoid contact with acids and oxidizers.

#### DIRECTIONS FOR USE

It is a violation of Federal Law to use this product in a manner inconsistent with its labeling. For use only in Sea-Bird Electronics' conductivity sensors. Read installation instructions in the applicable Conductivity Instrument Manual.

### **STORAGE AND DISPOSAL**

**PESTICIDE STORAGE:** Store in original container in a cool, dry place. Prevent exposure to heat or flame. Do not store near acids or oxidizers. Keep container tightly closed.

**PESTICIDE SPILL PROCEDURE:** In case of a spill, absorb spills with absorbent material. Put saturated absorbent material to a labeled container for treatment or disposal.

**PESTICIDE DISPOSAL:** Pesticide that cannot be used according to label instructions must be disposed of according to Federal or approved State procedures under Subtitle C of the Resource Conservation and Recovery Act.

**CONTAINER HANDLING:** Nonrefillable container. Do not reuse this container for any other purpose. Offer for recycling, if available.

# Appendix V: Replacement Parts

Part Number	Part	Application Description	Quantity in MicroCAT
50441	AA Saft Lithium battery set (12)	Power MicroCAT	1
801542	AF24173 Anti-Foulant Device	Bis(tributyltin) oxide device inserted in anti-foulant device cup	1 (set of 2)
233542	Anti-foulant device cup	Holds 2 AF24173 Anti-Foulant Devices	1
233540	Anti-foulant device cap	Secures AF24173 Anti-Foulant Device in cup	2
30984	Plug	Seals end of anti-foulant cap when not deployed, keeping dust and aerosols out of conductivity cell during storage	2
30411	Triton X-100	Octyl Phenol Ethoxylate – Reagent grade non-ionic cleaning solution for conductivity cell (supplied in 100% strength; dilute as directed)	1
30507	Parker 2-206N674-70 O-ring	O-ring between end of conductivity cell and anti-foulant device cup	2
60049	Spare hardware/O-ring kit for 37-SM / -SMP with titanium housing	Assorted hardware and O-rings, including: <ul style="list-style-type: none"> <li>• 30900 Bolt, 1/4-20 x 2" hex head, titanium (secures mounting clamp)</li> <li>• 30633 Washer, 1/4" split ring lock, titanium (for 30900)</li> <li>• 30634 Washer 1/4" flat, titanium (for 30900)</li> <li>• 31019 O-ring Parker 2-008 N674-70 (for 30900, retains mounting clamp hardware)</li> <li>• 31040 Screw, 8-32 x 1 FH, titanium (secures cable guide base to connector end cap)</li> <li>• 30860 Screw, 6-32 x 1/2 FH, titanium (secures cable clamp half to flat area of sensor end cap)</li> <li>• 30544 Screw 8-32 x 1/2 FH, titanium (secures cell guard to housing)</li> <li>• 30859 Screw, 8-32 x 3/8" FH, titanium (secures housing to connector end cap)</li> <li>• 30857 Parker 2-033E515-80 O-ring (connector end cap and sensor end cap O-ring)</li> <li>• 31749 Hex key, 7/64 inch, long arm (secures battery pack in housing with captured screw)</li> <li>• 31322 O-ring Parker 2-130 N674-70 (for grooves on side of battery pack)</li> <li>• 30858 O-ring Parker 2-133 N674-70 (for battery pack cover plate)</li> </ul>	-

*Continued on next page*

Continued from previous page

Part Number	Part	Application Description	Quantity in MicroCAT
60053	Spare hardware/O-ring kit for 37-SM / -SMP with plastic housing	Assorted hardware and O-rings, including: <ul style="list-style-type: none"> <li>• 30900 Bolt, 1/4-20 x 2" hex head, titanium (secures mounting clamp)</li> <li>• 30633 Washer, 1/4" split ring lock, titanium (for 30900)</li> <li>• 30634 Washer 1/4" flat, titanium (for 30900)</li> <li>• 31019 O-ring Parker 2-008 N674-70 (for 30900, retains mounting clamp hardware)</li> <li>• 31040 Screw, 8-32 x 1 FH, titanium (secures cable guide base to connector end cap)</li> <li>• 30860 Screw, 6-32 x 1/2 FH, titanium (secures cable clamp half to flat area of sensor end cap)</li> <li>• 30544 Screw 8-32 x 1/2 FH, titanium (secures cell guard to housing)</li> <li>• 31755 Cap screw, 8-32 x 1/4" SH, titanium (secures connector end cap to housing)</li> <li>• 31516 Hex key, 9/64 inch long arm (for installing 31755)</li> <li>• 30857 Parker 2-033E515-80 O-ring (connector end cap and sensor end cap O-ring)</li> <li>• 31749 Hex key, 7/64 inch, long arm (secures battery pack in housing with captured screw)</li> <li>• 31322 O-ring Parker 2-130 N674-70 (for grooves on side of battery pack)</li> <li>• 30858 O-ring Parker 2-133 N674-70 (for battery pack cover plate)</li> </ul>	-
801385	4-pin RMG-4FS to 9-pin DB-9S I/O cable with power leads, 2.4 m (8 ft) *	From MicroCAT to computer	1
801206	4-pin MCIL-4FS (wet-pluggable connector) to 9-pin DB-9S I/O cable with power leads, 2.4 m (8 ft)	From MicroCAT to computer	1
171888	25-pin DB-25S to 9-pin DB-9P cable adapter	For use with computer with DB-25 connector	1
17046.1	4-pin RMG-4FS dummy plug with locking sleeve *	For when cable not used	1
171398.1	4-pin MCDC-4F (wet-pluggable connector) dummy plug, with locking sleeve	For when cable not used	1
17043	Locking sleeve for RMG cable	Locks cable/plug in place	1
171192	Locking sleeve for MCIL cable	Locks cable/plug in place	1

\* For standard XSG-type connector.

# Appendix VI: Manual Revision History

Manual Version	Date	Description
001	04/03	<ul style="list-style-type: none"> <li>Initial release.</li> </ul>
002	04/04	<ul style="list-style-type: none"> <li>Add description of flow path u-shape and necessary orientation.</li> <li>Add information about pump: Pump comes on when acquisition microcontroller turns on, not communication microcontroller. Do not send global acquisition commands if externally powering with multiple units – too much power surge.</li> <li>MicroCAT can transmit data over up to 1200 m of 26 AWG twisted pair wire cable.</li> <li>Update external power specification to 12-24 instead of 9-24 VDC, to prevent draining batteries.</li> <li>Add information on total cable resistance and on transient current needed for pump turn-on, for optional external power.</li> <li>Reference pressure line appears in <b>DS</b> reply only if no pressure sensor installed.</li> <li>Add more information about limitations on shipping lithium batteries.</li> <li>Add information in test section about setting ID.</li> <li>Add information on wiring termination for RS-485.</li> </ul>
003	06/04	<ul style="list-style-type: none"> <li>Acquisition Firmware 2.3: new board layout, new power specifications.</li> <li>Update power consumption / cable length calculations.</li> <li>Add <b>!iTXDelay=</b> and <b>!iRXDelay=</b> commands.</li> <li>Add information in test section about setting ID.</li> <li>Add more information on disabling serial line sync mode.</li> </ul>
004	05/05	<ul style="list-style-type: none"> <li>Add 600 m Druck pressure sensor.</li> <li>Update cleaning recommendations to correspond to revised application note 2D.</li> <li>Update AF24173 Anti-Foulant Device appendix to current label.</li> <li>Add troubleshooting section.</li> <li>Update battery shipping precautions.</li> <li>Add details on how to process MicroCAT data in SBE Data Processing's Derive module.</li> <li>Add caution about not running pump dry.</li> </ul>
005	05/06	<ul style="list-style-type: none"> <li>Update wet-pluggable connector information.</li> <li>Add more information to Recovery Warning.</li> </ul>
006	12/06	<ul style="list-style-type: none"> <li>Incorporate new bleed hole, change orientation recommendation.</li> <li>Add option for 250 m plastic housing.</li> <li>Add more explanation of ncycles in status response.</li> <li>Update pressure port maintenance – SBE no longer putting silicon oil in port.</li> </ul>
007	06/07	<ul style="list-style-type: none"> <li>Add handling precautions for plastic housing.</li> </ul>
008	06/08	<ul style="list-style-type: none"> <li>Update for Version 3 firmware changes: many commands changed, power specifications changed, pump operation changed.</li> <li>Add deployment recommendation that 37-SMP should be inclined <math>\geq 10</math> degrees from horizontal.</li> <li>Change stability specification for pressure to per year instead of per month.</li> <li>Update connector maintenance information for consistency with application note 57.</li> <li>Add information that <b>POffset</b> is in decibars.</li> </ul>
009	07/08	<ul style="list-style-type: none"> <li>Update battery installation procedure, specifications, endurance, and shipping instructions for new battery packs (12 AA lithium cells).</li> </ul>
010	08/08	<ul style="list-style-type: none"> <li>Acquisition Firmware revision 3.0c: <ul style="list-style-type: none"> <li>- Add new output format to match format available from firmware &lt; 3.0. <b>DDb,e</b> now uploads data in this new format.</li> <li>- If <b>StartLater</b>&gt;90 days in future, does <b>StartNow</b>.</li> </ul> </li> <li>Manufacturing change: for plastic housing, 2 phillips-head screws at connector end cap end and 1 at sensor end cap end are replaced with hex screws. 9/64" allen wrench shipped with instrument.</li> </ul>
011	01/09	<ul style="list-style-type: none"> <li>Update for SeatermV2 terminal program.</li> <li>Add information about compatibility with Vista.</li> <li>Correction: Add PTempA0, PTempA1, PTempA2 to calibration coefficient commands.</li> </ul>

Continued on next page



*Continued from previous page*

012	01/10	<ul style="list-style-type: none"> <li>• Acquisition Firmware 3.0f: changed <b>#iiOutputFormat=3</b> so that it does not send ii (ID) in response to polled sampling command, providing compatibility with firmware &lt; 3.0. This makes the current firmware fully compatible with systems set up for firmware &lt; 3.0.</li> <li>• Add information to description for serial line sync mode when transmitting real-time: can only have 1 MicroCAT on line, or replies collide.</li> <li>• Change Seasoft-Win32 to Seasoft V2, update file name to SeasoftV2_date.exe.</li> <li>• SBE Data Processing 7.20a: Add information about .xmlcon file.</li> <li>• Add CE mark.</li> <li>• Update SBE address.</li> <li>• Update anti-foul label in Appendix with new Container Handling requirement and new address.</li> </ul>
013	07/10	<ul style="list-style-type: none"> <li>• Acquisition Firmware 3.0h: Fixed bug related to <b>StartDateTime=</b>. Previously, when <b>StartLater</b> was sent, register ignored month in <b>StartDateTime</b>, and started at the next day and time corresponding to the day and time (example: if it is July 1 and you set it to start on August 15, it ignored the August part of the date, and started on July 15). Documentation said could be started 90 days out, but this actually limited it to 30 days out. Now, it provides a message saying it will start logging in 5 seconds if the start date is more than 30 days out.</li> <li>• Add 60053 spares kit for plastic housing.</li> </ul>
014	10/10	<ul style="list-style-type: none"> <li>• Update for changes to SeatermV2 version 1.1 (upload now converts .xml file to .hex and .xmlcon files, which are used in Data Conversion to convert to .cnv file for further processing).</li> <li>• Remove references to Druck pressure sensors (pressure sensors can be supplied by other manufacturers).</li> </ul>
015	03/11	<ul style="list-style-type: none"> <li>• SeatermV2 1.1b changes: <ul style="list-style-type: none"> <li>- Update upload procedure, Seaterm232 now automatically starts SBE Data Processing after upload.</li> <li>- Update SeatermV2 Instruments list screen capture.</li> </ul> </li> <li>• Add information about compatibility with Windows 7.</li> </ul>

# Index

---

## A

Air bleed hole · 46, 58  
 Anti-Foulant Device · 74  
   removal before shipping to Sea-Bird · 63  
   replacing · 61, 62  
 Autonomous sampling · 24, 39

---

## B

Batteries · 10, 47  
   description · 14  
   endurance · 12  
   installing · 14  
   replacing · 60  
   shipping precautions · 7  
 Baud command · 36  
 Bleed hole · 46, 58

---

## C

Cable length · 13, 26  
 Cable termination · 26  
 Calibration · 63  
 Calibration coefficients · 42  
 Cleaning · 58  
 Clock · 10  
 Command summary · 71  
 Commands  
   autonomous sampling · 39  
   baud · 36  
   calibration coefficients · 42  
   communications · 36  
   data format · 38  
   data upload · 41, 50  
   date and time · 28, 36  
   descriptions · 27  
   general setup · 36  
   get data · 28  
   global · 28  
   hardware configuration · 42  
   logging · 39  
   memory setup · 38  
   MicroCAT ID · 28  
   output format · 38  
   polled sampling · 40  
   pressure sensor · 42  
   pump setup · 37, 42  
   serial line sync · 40  
   status · 29  
   upload · 50  
 Communication defaults · 19  
 Communications setup commands · 36  
 Conductivity cell · 69  
   cleaning · 58  
 Conductivity sensor calibration · 63  
 Connector · 11, 57  
 Corrosion precautions · 57

---

## D

Data commands · 28  
 Data Conversion · 53  
 Data format · 38, 43  
 Data processing · 9, 16, 50, 53  
 Data upload · 41, 50  
 Date and time · 28, 36  
 Deployment · 46  
   installation · 48  
   preparing for · 14  
   setup · 47  
 Deployment orientation · 9, 11, 48  
 Derive · 53  
 Description · 8  
 Dimensions · 11

---

## E

Electronics disassembly/reassembly · 70  
 End cap · 11, 57  
 External power · *See* Power, external

---

## F

Flooded instrument · 49  
 Format  
   data · 43  
 Functional description · 69

---

## G

Global commands · 28  
 Glossary · 67  
 Guard  
   removal · 61, 62

---

## H

Hardware configuration · 42

---

## I

ID · 17, 28  
 Initializing memory · 38

---

## L

Limited liability statement · 2  
 Logging · 24, 39

---

## M

Maintenance · 57  
 Manual revision history · 80  
 Memory · 10  
 Memory setup · 38  
 Modes · *See* Sampling modes  
 Mounting · 46

---

**O**

Operation description · 22  
 Orientation · 46  
 Output format · 38, 43

---

**P**

Parker Super O-Lube · 68  
 Parts  
   replacement · 78  
 Plastic housing  
   handling · 59  
 Plumbing  
   maintenance · 58  
 Polled sampling · 23, 40  
 Power · 13  
   external · 10, 13  
 Pressure sensor · 69  
   maintenance · 60  
 Pressure sensor calibration · 64  
 Pressure sensor setup · 42  
 Processing data · 50  
 Pump · 9, 10, 11, 39, 46, 48  
 Pump setup · 42  
 Pump setup commands · 37

---

**Q**

Quick start · 5

---

**R**

Real-time setup  
   cable length · 26  
 Recovery · 49  
   uploading data · 50  
 Replacement parts · 78  
 Revision history · 80

---

**S**

Sample timing · 12  
 Sampling modes · 23  
   autonomous · 24, 39  
   logging · 24, 39  
   polled · 23, 40  
   serial line sync · 25, 40  
 SBE Data Processing · 9, 16, 53  
 Sea Plot · 53  
 SEASOFT · 9, 16  
 Seaterm485 · 9, 16, 17, 50  
 SeatermV2 · 9, 16, 17, 50  
 Sensors · 10  
 Serial line sync · 25, 40  
 Setup commands · 36  
 ShallowCAT  
   handling · 59  
 Shipping precautions · 7  
 Software · 9, 16  
 Specifications · 10  
 Status commands · 29  
 Storage · 58  
 Super O-Lube · 68  
 System description · 8

---

**T**

Temperature sensor calibration · 63  
 Terminal program · 9, 16, 17, 50  
 Termination · 26  
 Testing · 16  
 Thermistor · 69  
 Timeout description · 27  
 Triton · 68  
 Troubleshooting · 65

---

**U**

Unpacking MicroCAT · 6  
 Upload · 41  
 Uploading data · 50

---

**V**

Versions · 80

---

**W**

Wiring · 16