

# SBE 48 Hull Temperature Sensor

---

*With RS-232 Serial Interface*

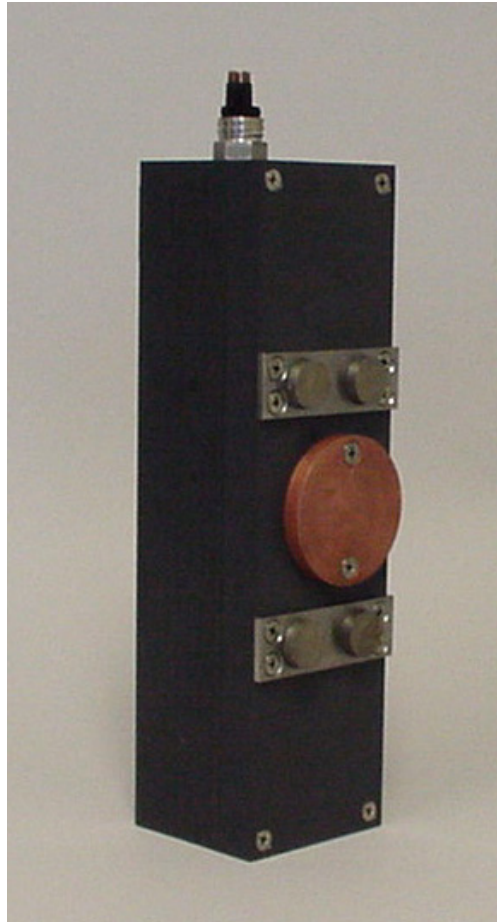

**Note: NEW ADDRESS**  
as of January 18, 2010

## **User's Manual**

---

Sea-Bird Electronics, Inc.  
13431 NE 20<sup>th</sup> Street  
Bellevue, Washington 98005 USA  
Telephone: 425/643-9866  
Fax: 425/643-9954  
E-mail: seabird@seabird.com  
Website: www.seabird.com

**Manual Version #004, 07-24-08**  
**Firmware Version 2.0**

# Limited Liability Statement

Extreme care should be exercised when using or servicing this equipment. It should be used or serviced only by personnel with knowledge of and training in the use and maintenance of oceanographic electronic equipment.

SEA-BIRD ELECTRONICS, INC. disclaims all product liability risks arising from the use or servicing of this system. SEA-BIRD ELECTRONICS, INC. has no way of controlling the use of this equipment or of choosing the personnel to operate it, and therefore cannot take steps to comply with laws pertaining to product liability, including laws which impose a duty to warn the user of any dangers involved in operating this equipment. Therefore, acceptance of this system by the customer shall be conclusively deemed to include a covenant by the customer to defend, indemnify, and hold SEA-BIRD ELECTRONICS, INC. harmless from all product liability claims arising from the use or servicing of this system.

# Table of Contents

<b>Section 1: Introduction</b> .....	<b>4</b>
About this Manual .....	4
How to Contact Sea-Bird .....	4
Quick Start .....	4
Unpacking SBE 48.....	5
Shipping Precautions .....	6
<b>Section 2: Description of SBE 48</b> .....	<b>7</b>
System Description .....	7
Specifications.....	8
Dimensions and Connector .....	9
Sample Timing.....	10
Battery Endurance.....	10
<b>Section 3: Preparing SBE 48 for Deployment</b> .....	<b>11</b>
Installing Software.....	11
Power and Communications Test .....	11
<b>Section 4: Deploying and Operating SBE 48</b> .....	<b>16</b>
Sampling Modes .....	16
Polled Sampling (Operating commands) .....	16
Autonomous Sampling (Logging commands) .....	17
Serial Line Sync.....	18
Baud Rate and Cable Length .....	19
Command Descriptions.....	19
Data Output Formats.....	27
Setup for Deployment.....	27
Deployment.....	28
Uploading Data .....	29
<b>Section 5: Routine Maintenance and Calibration</b> .....	<b>34</b>
Corrosion Precautions.....	34
Sensor Calibration.....	34
Replacing Battery .....	35
<b>Glossary</b> .....	<b>36</b>
<b>Appendix I: Functional Description</b> .....	<b>37</b>
Sensor .....	37
Sensor Interface .....	37
Real-Time Clock.....	37
Memory.....	37
<b>Appendix II: Plot39 Data Plotting Program</b> .....	<b>39</b>
<b>Appendix III: Command Summary</b> .....	<b>40</b>
<b>Appendix IV: Replacement Parts</b> .....	<b>42</b>
<b>Index</b> .....	<b>43</b>

# Section 1: Introduction

This section includes contact information, Quick Start procedure, photos of a standard SBE 48 shipment, and shipping precautions.

---

## About this Manual

This manual is to be used with the SBE 48 Hull Temperature Sensor.

It is organized to guide the user from installation through operation and data collection. We've included detailed specifications, command descriptions, maintenance and calibration information, and helpful notes throughout the manual.

Sea-Bird welcomes suggestions for new features and enhancements of our products and/or documentation. Please e-mail any comments or suggestions to [seabird@seabird.com](mailto:seabird@seabird.com).

---

## How to Contact Sea-Bird

Sea-Bird Electronics, Inc.  
1808 136<sup>th</sup> Place Northeast  
Bellevue, Washington 98005 USA  
Telephone: 425-643-9866                      Fax: 425-643-9954  
E-mail: [seabird@seabird.com](mailto:seabird@seabird.com)                      Website: <http://www.seabird.com>

Business hours:  
Monday-Friday, 0800 to 1700 Pacific Standard Time  
(1600 to 0200 Universal Time)  
Except from April to October, when we are on *summer time*  
(1500 to 0000 Universal Time)

---

## Quick Start

Follow these steps to get a Quick Start using the SBE 48. The manual provides step-by-step details for performing each task:

1. Test Power and Communications (*Section 3: Preparing SBE 48 for Deployment*).
2. Deploy the SBE 48 (*Section 4: Deploying and Operating SBE 48*):
  - A. Install a new battery if necessary (*Section 5: Routine Maintenance and Calibration*).
  - B. Ensure all data has been uploaded, and then set **SampleNum=0** to make entire memory available for recording if desired.
  - C. Set date and then time.
  - D. Establish logging parameters.
  - E. Set SBE 48 to start logging now or in the future.
  - F. Install dummy plug or I/O cable, and locking sleeve.
  - G. Using magnets on housing, mount SBE 48 on inside of ship's hull below the waterline.

## Unpacking SBE 48

Shown below is a typical SBE 48 shipment.



SBE 48



I/O Cable



25-pin to 9-pin adapter  
(for use with computer  
with DB-25 connector)



SBE 48 User Manual



Software, and Electronic Copies of  
Software Manuals and User Manual

## Shipping Precautions

**WARNING!**

**Do not ship spare batteries by passenger aircraft.**

The SBE 48 was shipped from the factory with the lithium battery inside the instrument. When shipped in this manner, the lithium battery is **not** considered Dangerous/Hazardous Goods, and may be shipped via commercial aircraft (those governed by DOT or IATA, including passenger airlines, or cargo carriers such as FedEx, DHL, UPS, etc.) if no more than the one battery required to operate the instrument is included in the shipment (i.e., no spares are included). For international shipments, the airway bill must include the phrase, "Non Restricted Per Special Provision A45".

**Note:**

Remove the battery before returning the SBE 48 to Sea-Bird. Do not return the used battery to Sea-Bird when shipping the SBE 48 for repair or recalibration.

All setup information is preserved in EEPROM when the battery is removed.

**IMPORTANT NOTE:**

**Do not ship spare lithium batteries via passenger aircraft.** Refer to *Lithium Battery Shipping Guidelines* for background information on the applicable regulations as well as Sea-Bird's interpretation of those regulations, how they apply to the batteries in our equipment, and how we package and label our equipment.

# Section 2: Description of SBE 48

This section describes the functions and features of the SBE 48, including specifications, dimensions, sample timing, and battery endurance.

---

## System Description

The SBE 48 is a high-accuracy temperature recorder with non-volatile memory, designed for shipboard determination of sea surface temperature. Installed with magnets just below the water line, the SBE 48's temperature sensor is in contact with the **inside** of the ship's hull. The SBE 48's internal battery runs the real-time clock and can be used to power the SBE 48 for very short deployments; external power is recommended for typical deployments.

The SBE 48 retains the temperature sensor used in the SBE 39 Temperature Recorder. The SBE 48's thermistor has a long history of exceptional accuracy and stability (typical drift is less than 0.002 °C per year).

The SBE 48 communicates directly with a computer via a standard RS-232 interface. Baud rates of 1200 to 38,400 are user-selectable. Setup and extraction of data from the SBE 48 is done via an I/O data cable plugged into an external connector. Calibration coefficients stored in EEPROM allow the SBE 48 to transmit data in engineering units.

Commands can be sent to the SBE 48 to provide status display, data acquisition setup, data retrieval, and diagnostic tests. User-selectable operating modes include:

- **Polled sampling** – The SBE 48 takes one sample and sends the data to the computer. Polled sampling is useful for testing.
- **Autonomous sampling** – There are two types of Autonomous sampling.
  - *Interval sampling*: At pre-programmed intervals, the SBE 48 wakes up, samples, stores data in memory, and powers off (enters quiescent state).
  - *Continuous sampling*: The SBE 48 continuously samples and stores data in memory, and does not power off between samples.

The SBE 48 also calculates a running average of up to 120 temperature samples, which can be transmitted while logging data.

- **Serial Line Sync** - A pulse on the serial line causes the SBE 48 to wake up, sample, store data in memory, and power off. This mode provides easy integration with other instruments that can synchronize SBE 48 sampling with their own.

Future upgrades and enhancements to the SBE 48 firmware can be easily installed in the field through a computer serial port and the external connector on the SBE 48, without the need to return the SBE 48 to Sea-Bird.

The SBE 48 is supplied with a powerful Win 2000/XP software package, SEASOFT-Win32, which includes:

- **SEATERM** - terminal program for easy communication and data retrieval.
- **Plot39** - program for plotting data from an SBE 48 or SBE 39.
- **SBE Data Processing** – program includes many post-processing modules; modules applicable to the SBE 48 are ASCII Out (export files for other programs) and Sea Plot (plot data).

### Notes:

- Help files provide detailed information on the use of SEATERM, Plot39, and SBE Data Processing.
- A separate software manual on CD-ROM contains detailed information on the use of SBE Data Processing.

## Specifications

<b>Measurement Range</b>	-5 to +35 °C
<b>Initial Accuracy</b>	0.002 °C
<b>Typical Stability</b>	0.0002 °C per month
<b>Resolution</b>	0.0001 °C
<b>Sensor Calibration</b>	+1 to +32 °C
<b>Memory</b>	64 Mbyte non-volatile FLASH memory (32,900,000 bytes usable)
<b>Data Storage</b>	Converted temperature: 3 bytes per sample. Time: 4 bytes per sample. Memory space (temperature and time): 4,700,000 samples.
<b>Real-Time Clock</b>	32,768 Hz TCXO accurate to ±1 minute/year
<b>Internal Battery</b>	9-volt lithium battery (unrestricted) - runs real-time clock; can also be used to power SBE 48, if external power is not supplied
<b>External Power</b>	8 - 16 VDC. The SBE 48 is typically deployed with external power. The internal lithium battery is diode-OR'd with the external source, so power will be drawn from whichever voltage source is higher.
<b>Current</b>	<i>Quiescent Current:</i> 10 microamps <i>Current Consumption (per sample):</i> 0.018 Amp-second <i>Current Consumption (continuous sampling):</i> 15 milliAmps
<b>Battery Endurance</b>	Running clock only: 5 to 10 years Providing power for logging: 180,000 samples
<b>Materials</b>	PVC housing
<b>Weight</b>	2.3 kg (5 lbs)

**Note:**

If the SBE 48 is logging data and the voltage is less than 6.25 volts for 10 consecutive scans, the SBE 48 halts logging and displays a low battery indication in the data.



## Dimensions and Connector

*Dimensions in millimeters (inches)*

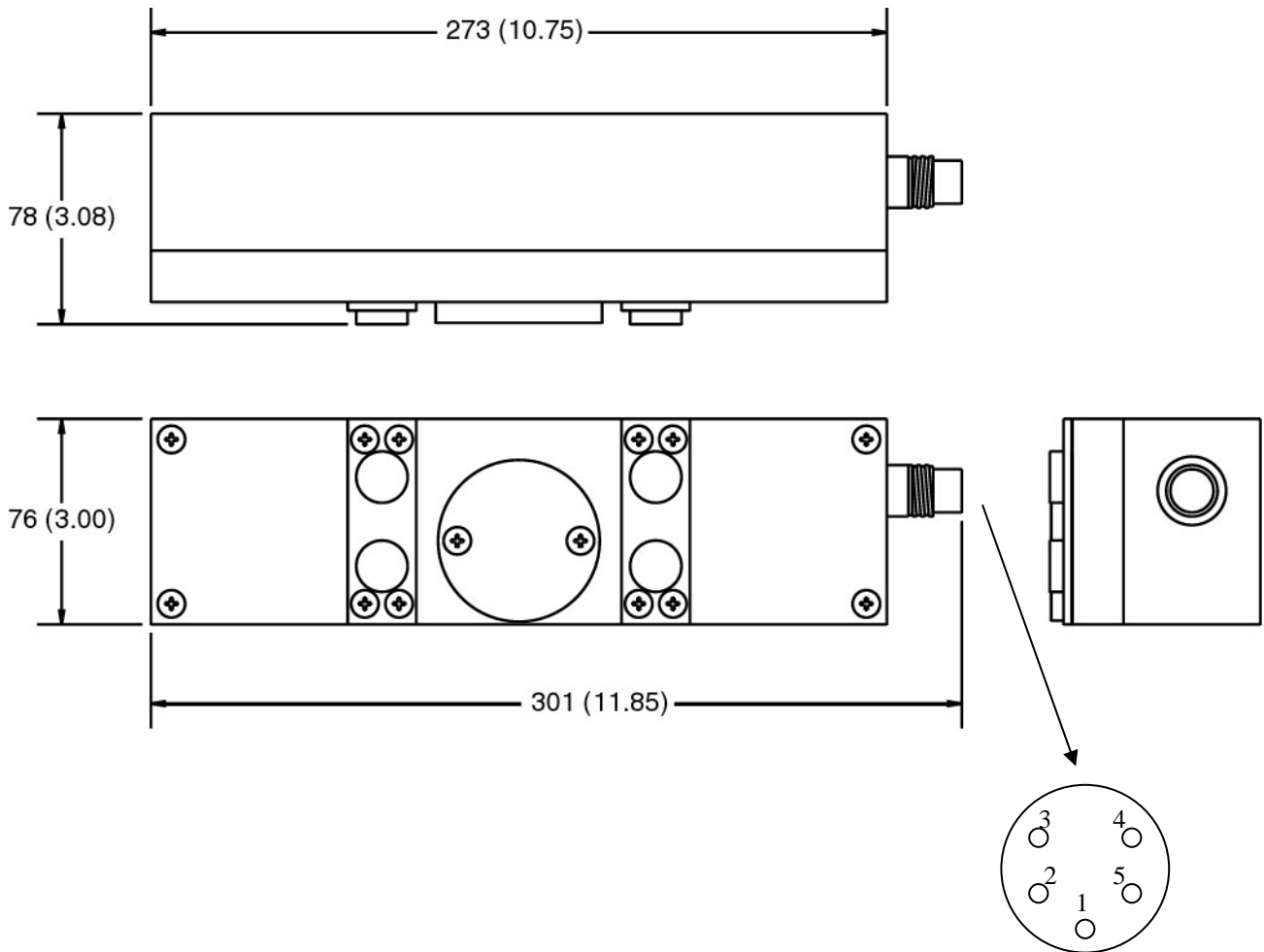

Pin	Description
1	Ground
2	Transmit: RS-232C transmit data from SBE 48 to computer
3	Power: 8 - 16 VDC external power
4	Receive: RS-232C receive data transmitted from computer
5	Shield

## Sample Timing

**Note:**

Sampling time shown does not include time to transmit real-time data, which is dependent on baud rate.

Time required to transmit data =  
 (# of characters \* 10 bits/character) / baud

This corresponds to 0.28 seconds at 1200 baud to 0.01 seconds at 38400 baud.

Minimum timing between samples is dependent on whether real-time output is provided (**TxRealTime=**).

The table below provides the approximate interval between samples if the SBE 48 is set up for continuous sampling:

Real-Time Output?	Time (seconds)
No ( <b>TxRealTime=N</b> )	0.80
Yes ( <b>TxRealTime=Y</b> )	1.00

## Battery Endurance

**Notes:**

- If the SBE 48 is logging data and the battery voltage is less than 6.25 volts for ten consecutive scans, the SBE 48 halts logging and displays a low battery indication in the data.
- **See Specifications above for data storage limitations.**

Battery capacity is as follows:

- **Standard lithium battery** - nominal capacity is 1.2 amp-hours. For planning purposes, use a conservative value of 1.1 amp-hours.
- **Duracell MN1604 alkaline battery** - nominal capacity is 0.4 amp-hours. For planning purposes, use a conservative value of 0.3 amp-hours.

Current consumption is as follows:

- Sampling (acquisition) current for *continuous, autonomous sampling* is 15 milliAmps.
- Sampling (acquisition) current for *polled sampling; interval, autonomous sampling; or serial line sync sampling* is 18 milliAmp-seconds/sample
- Quiescent current is 10 microAmps (0.09 AH per year).

So, battery endurance is dependent on the application. An example is shown below for two sampling schemes.

*Example 1:* SBE 48 is set up to sample autonomously every 5 minutes (12 samples/hour). How long can it be deployed with a lithium battery?

Sampling current consumption = 18 milliamp-seconds/sample = 0.018 amp-seconds/sample

In 1 hour, sampling current consumption = 12 \* 0.018 amp-seconds/sample = 0.216 amp-seconds/hour

Quiescent current = 10 microamps = 0.01 mA = 0.00001 amps

In 1 hour, quiescent current consumption = 0.00001 mA \* 3600 seconds/hour = 0.036 amp-seconds/hour

Current consumption / hour = 0.216 + 0.036 = 0.252 amp-seconds/hour

Capacity = (1.1 amp-hours \* 3600 seconds/hr) / (0.252 amp-seconds/hour) = 15714 hours = 654 days = 1.7 years

Total number of samples = 15714 hours \* 12 samples/hour = 188,000 samples

*Example 2:* SBE 48 is set up to sample continuously. How long can it be deployed with a lithium battery?

Sampling current consumption = 15 milliamps = 0.015 amps

Capacity = (1.1 amp-hours) / (0.015 amps) = 73 hours

# Section 3:

## Preparing SBE 48 for Deployment

This section describes installing software and the pre-check procedure for preparing the SBE 48 for deployment.

### Installing Software

Sea-Bird recommends the following minimum system requirements for SEASOFT-Win32: Pentium 90 CPU, 64 Mbyte RAM, Windows 98 or later.

If not already installed, install SEATERM and other Sea-Bird software programs on your computer using the supplied software CD:

**Note:**

It is possible to use the SBE 48 without SEATERM by sending direct commands from a dumb terminal or terminal emulator, such as Windows HyperTerminal.

1. Insert the CD in your CD drive.
2. Double click on **Seasoft-Win32.exe**.
3. Follow the dialog box directions to install the software.

The default location for the software is c:\Program Files\Sea-Bird. Within that folder is a sub-directory for each program. The installation program allows you to install the desired components. Install all the components, or just install SEATERM for now.

### Power and Communications Test

**Note:**

Sea-Bird ships the SBE 48 with a 9-volt lithium battery installed. See *Section 5: Routine Maintenance and Calibration* for details on replacing the battery.

The power and communications test will verify that the system works, prior to deployment.

#### Test Setup

1. Install the I/O cable connector (see *Dimensions and Connector* in *Section 2: Description of SBE 48*):
  - A. Lightly lubricate the sides of the rubber prongs on the SBE 48 bulkhead connector with silicone grease (DC-4 or equivalent).
  - B. Install the cable connector, aligning the holes with the five pins on the SBE 48's bulkhead connector.
  - C. Place the locking sleeve over the connector. Tighten the locking sleeve finger tight only. **Do not overtighten the locking sleeve and do not use a wrench or pliers.**
  - D. Connect the I/O cable connector to your computer's serial port.
  - E. Connect the I/O cable connector's red (+) and black (-) wires to a power supply (8 - 16 VDC).

**CAUTION:**

**Do not use WD-40** or other petroleum-based lubricants, as they will damage the connector.

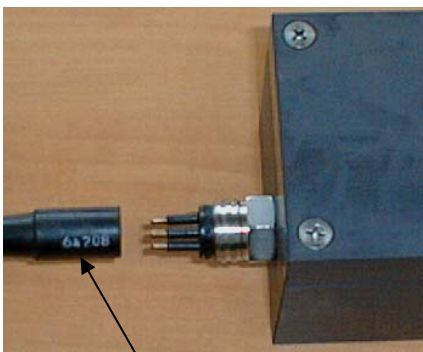

I/O cable connector

## Test

### Notes:

- See SEATERM's Help files.
- The SBE 48 is not available in the list of instrument types. **Select the SBE 39 as the instrument type.**

1. Double click on SeaTerm.exe. If this is the first time the program is used, the setup dialog box appears:

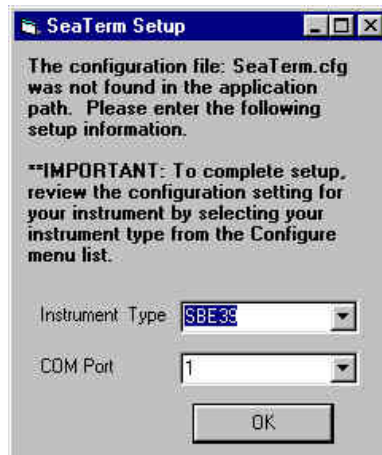

Select the instrument type (**SBE 39**) and the computer COM port for communication with the instrument. Click OK.

2. The main screen looks like this:

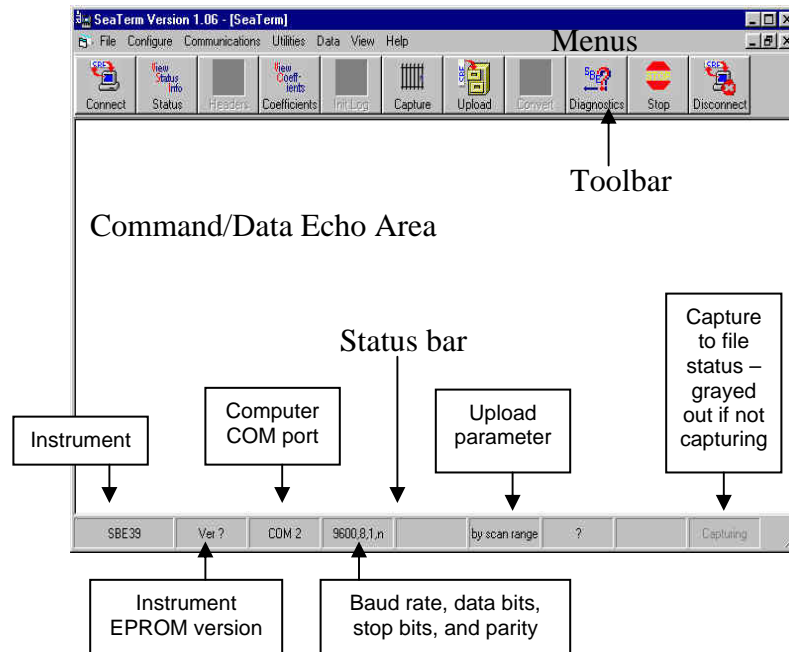

### Note:

There is at least one way, and as many as three ways, to enter a command:

- Manually type a command
- Use a menu to automatically generate a command
- Use a Toolbar button to automatically generate a command

### Note:

Once the system is configured and connected (Steps 3 and 4 below), to update the Status bar:

- on the Toolbar, click Status; or
- from the Utilities menu, select Instrument Status.

SEATERM sends the status command; the response displays in the Data Echo Area, and the Status bar is updated.

- **Menu** – Contains tasks and frequently executed instrument commands.
- **Toolbar** – Contains buttons for frequently executed tasks and instrument commands. All tasks and commands accessed through the Toolbar are also available in the Menu. To display or hide the Toolbar, select View Toolbar in the View menu. Grayed out Toolbar buttons are not applicable.
- **Command/Data Echo Area** – Echoes a command executed using a Menu or Toolbar button, as well as the instrument's response. Additionally, a command can be manually typed in this area, from the available commands for the instrument. Note that the instrument must be *awake* for it to respond to a command (use Connect on the Toolbar to wake up the instrument).
- **Status bar** – Provides status information. To display or hide the Status bar, select View Status bar in the View menu.

Following are the Toolbar buttons applicable to the SBE 48:

<b>Toolbar Button</b>	<b>Description</b>	<b>Equivalent Command*</b>
Connect	Re-establish communications with SBE 48. Computer responds with S> prompt. SBE 48 <i>goes to sleep</i> after 2 minutes without communication from computer have elapsed.	(press Enter key)
Status	Display instrument setup and status (logging, number of samples in memory, etc.).	<b>DS</b>
Coefficients	Display calibration coefficients.	<b>DC</b>
Capture	Capture instrument responses on screen to file; useful for diagnostics. File has .cap extension. Press Capture again to turn off capture. Capture status displays in Status bar.	—
Upload	Upload data stored in SBE 48's memory, in format to allow for post-processing by Plot39 or SBE Data Processing. Uploaded data has .asc extension. Before using Upload: <ul style="list-style-type: none"> <li>• Configure upload and header parameters in Configure menu.</li> <li>• If Autonomous Sampling: Send <b>Stop</b> command to stop logging.</li> </ul>	<b>DDb,e</b> (use Upload button if you will be post-processing data with Plot39 or SBE Data Processing)
Convert	Convert uploaded .asc data file to a .cnv data file, which can then be processed by SBE Data Processing.	—
Diagnostics	Perform one or more diagnostic tests on SBE 48. Diagnostic test(s) accessed in this manner are non-destructive—they do not write over any existing instrument settings.	<b>DS, DC, TS, and TSR</b>
Stop	Interrupt and end current activity, such as logging, uploading, or diagnostic test.	—
Disconnect	Free computer COM port used to communicate with SBE 48. COM port can then be used by another program.	—

\*See *Command Descriptions* in Section 4: *Deploying and Operating SBE 48*.

3. In the Configure menu, select **SBE 39**. The dialog box looks like this:

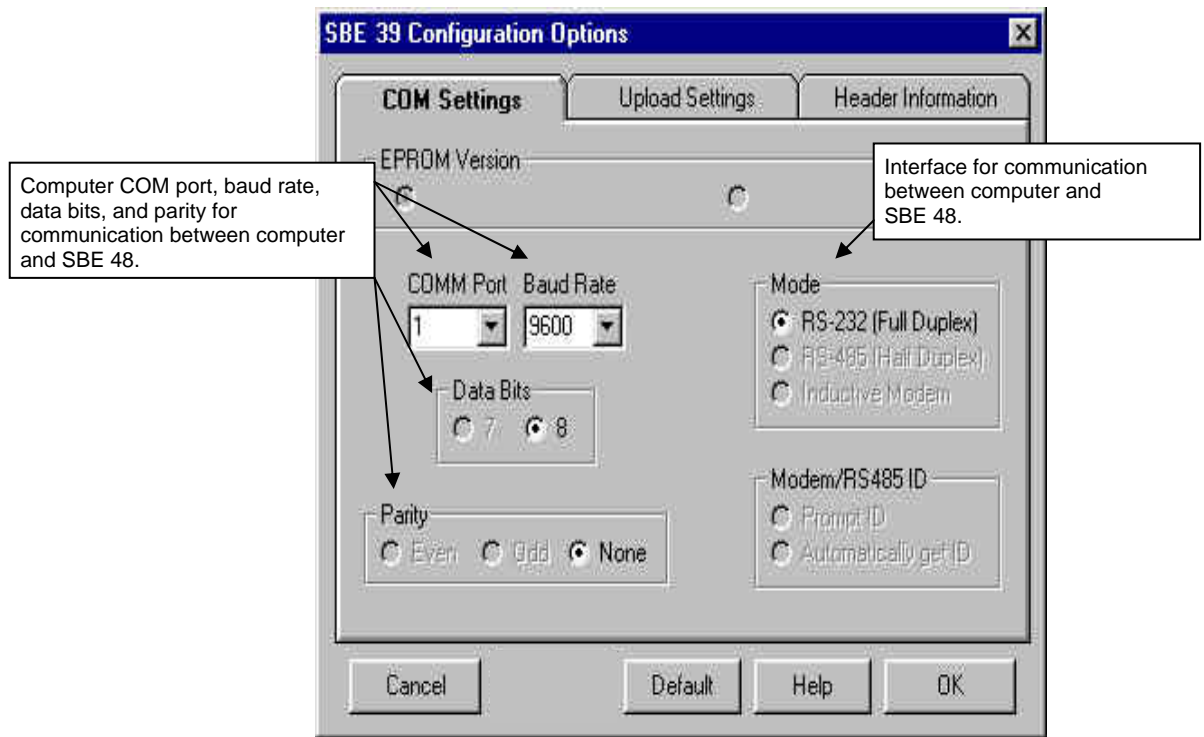

**Notes:**

- SEATERM's baud rate must be the same as the SBE 48's baud rate (set with **Baud=**). **Baud=** is factory-set to 9600, but can be changed by the user (see *Command Descriptions* in *Section 4: Deploying and Operating SBE 48*).
- When you click OK, SEATERM saves the Configuration Options settings to the SeaTerm.ini file in your Windows directory. SeaTerm.ini contains the last saved settings for **each** instrument. When you open SEATERM and select the desired instrument (SBE 37, 39, etc.) in the Configure menu, the Configuration Options dialog box shows the last saved settings for that instrument.

Make the selections in the Configuration Options dialog box:

- **COMM Port:** COM 1 through COM 10, as applicable
- **Baud Rate:** 9600 (documented on front cover of this manual)
- **Data Bits:** 8
- **Parity:** None
- **Mode:** RS-232 (Full Duplex)

Click OK to save the settings.

4. In the Communications menu, select *Options / Cycle baud when connecting*.
5. Click Connect on the Toolbar. SEATERM tries to connect to the SBE 48 at the baud set in Step 3. If it cannot, it cycles through all other possible baud rates to try to connect. When it connects, the display looks like this:

```
SBE 48
S>
```

This shows that correct communications between the computer and the SBE 48 has been established.

If the system does not respond as shown above:

- Click Connect again.
- Verify the correct instrument was selected in the Configure menu and the settings were entered correctly in the Configuration Options dialog box. Note that the baud rate's factory setting is documented on the front cover of this manual.
- Check cabling between the computer and the SBE 48.

6. Display SBE 48 status information by clicking Status on the Toolbar. The display looks like this:

**Note:**

The SBE 48 has a 2 minute timeout algorithm designed to:

- restore control to the computer if an illegal command is sent
- conserve power if too much time elapses between commands

If the system does not appear to respond, click Connect on the Toolbar to reestablish communications.

```
SBE 48 V 2.0 SERIAL NO. 0916 08 Aug 2008 08:49:09
battery voltage = 7.5
logging not started
sample interval = 30 seconds
number of samples to average = 60
samplenumber = 89, free = 4699778
serial sync mode disabled
real-time output disabled
binary upload includes time
temperature =19.48 deg C
```

7. Command the SBE 48 to take a sample by typing **TS** and pressing the Enter key. The display looks like this:

```
23.7658, 08 Aug 2008, 08:50:23
```

where 23.7658 = temperature in degrees Celsius  
08 Aug 2008 = date  
08:50:23 = time

These numbers should be reasonable; i.e., room temperature, current date and time (factory-programmed to Pacific Daylight or Standard Time; can be changed by user).

8. Command the SBE 48 to go to sleep (quiescent state) by typing **QS** and pressing the Enter key.

The SBE 48 is ready for programming and deployment.

# Section 4: Deploying and Operating SBE 48

This section provides discussions and instructions on:

- System operation
- Example sets of operation commands for each operating mode
- Real-time data acquisition
- Detailed command descriptions
- Data output formats
- Deployment
- Uploading data
- Processing data

---

## Sampling Modes

The SBE 48's user-selectable sampling modes for obtaining data include:

- Polled Sampling
- Autonomous Sampling - Interval and Continuous
- Serial Line Synchronization

Commands can be used in various combinations to provide a high degree of operating flexibility.

Descriptions and examples of the sampling modes follow. Note that the SBE 48's response to each command is not shown in the examples. Review the operation of the sampling modes and the commands described in *Command Descriptions* before setting up your system.

### Polled Sampling (Operating commands)

The SBE 48 takes one sample of data and sends the data to the computer. Storing of data in the SBE 48's FLASH memory is dependent on the particular command used.

*Example:* (user input in bold)

Establish communication with SBE 48. Command SBE 48 to take a sample and send converted data to computer (do not store data in memory). Send power-off command to SBE 48.

(Click Connect on Toolbar to wake up)

S>**TS**

S>**QS**



## Autonomous Sampling (Logging commands)

There are two types of Autonomous sampling:

- *Interval sampling*: At pre-programmed intervals, the SBE 48 wakes up, samples data and stores it in FLASH memory, and powers-off (enters quiescent state). The sampling interval is set with **Interval=**.
- *Continuous sampling*: The SBE 48 samples data continuously and stores it in FLASH memory, and does not power-off between samples. Continuous sampling is established by setting **Interval=0**. If not transmitting real-time output, the SBE 48 takes a sample at approximately 0.8-second intervals; if transmitting real-time data, the SBE 48 takes a sample at approximately 1.0-second intervals.

Logging is started with **StartNow** or **StartLater**, and is stopped with **Stop**. Transmission of real-time data to the computer is dependent on **TxRealTime=**.

**Note:**

Use **Stop** to:

- stop logging
- stop waiting to start logging (after **StartLater** has been sent)

*Example: Autonomous Sampling - Interval Sampling* (user input in bold)  
Establish communication. Set sample number to 0 to overwrite previous data in memory. Set up to sample every 10 seconds, store data in memory, and not transmit real-time data to computer. Set up to automatically start on 10 January 2009 at 12:00:00. Verify setup. Send power-off command to SBE 48 after all parameters are entered - system will automatically wake up and power down for each sample.

(Click Connect on Toolbar to wake up)

```
S>SAMPLENUM=0
S>INTERVAL=10
S>TXREALTIME=N
S>STARTMMDDYY=011009
S>STARTRHHMMSS=120000
S>STARTLATER
S>DS      (verify setup)
S>QS
```

When ready to upload all data to computer, establish communication with SBE 48, stop sampling, and upload data. Send power-off command.

(Click Connect on Toolbar to wake up)

(Press Enter key to get S> prompt)

```
S>STOP
```

(Click Upload on Toolbar – program leads you through screens to define data to be uploaded and where to store it)

```
S>QS
```

*Example: Autonomous Sampling - Continuous Sampling*

Same as above, but set **INTERVAL=0**.

## Serial Line Sync

Serial Line Sync allows a simple pulse on the RS-232 line to initiate a sample. This mode provides easy integration with other instruments that can synchronize SBE 48 sampling with their own, without drawing on their battery or memory resources.

If this mode is enabled (**SyncMode=Y**) and the SBE 48 is powered down, setting the RS-232 RX line high (3 –10 VDC) for 1 to 1000 milliseconds wakes up the SBE 48 and executes the following sequence:

- Take sample
- Store sample in FLASH memory
- Output real-time data if **TxRealTime=Y**

The SBE 48 then checks the RS-232 line:

- **Mark State** (RS-232 RX line less than 0.5 volts)  
SBE 48 immediately powers down. Serial line sync mode remains enabled (**SyncMode=Y**).
- **Space State** (RS-232 RX line greater than 3 volts)  
SBE 48 monitors the RS-232 line for 100 milliseconds:
  - If line remains in space state - SBE 48 disables serial line sync mode (**SyncMode=N**) at end of time. Once serial line sync mode is disabled, you can communicate with the SBE 48 using the full range of commands (operating, logging, upload commands, etc.).
  - If line returns to mark state - SBE 48 immediately powers down. Serial line sync mode remains enabled (**SyncMode=Y**).

**Note:**

If running **SEATERM**, select *Send 5 second break* in the Communications menu to hold the RS-232 RX line in space state for 5 seconds. This will cause the SBE 48 to exit Serial Line Sync Mode.

In summary, to disable serial line sync after taking a sample, put the RS-232 line in space state (greater than 3 volts) for 100 milliseconds.

*Example: Serial Line Sync Mode* (user input in bold)

Establish communication. Set sample number to 0 to overwrite previous data in memory. Do not transmit real-time data to computer. Enable serial line sync mode. Verify setup. Send power-off command.

(Click Connect on Toolbar to wake up)

```
S>SAMPLENUM=0
S>TXREALTIME=N
S>SYNCSMODE=Y
S>DS      (to verify setup)
S>QS
```

Take samples using serial line sync mode:

(Set RS-232 RX line high [3-10 VDC] for 1-1000 milliseconds. SBE 48 takes sample and stores data in memory. Within 100 milliseconds, set RS-232 RX line to mark state [less than 0.5 volts]; SBE 48 powers down.) (Repeat this process at periodic intervals as desired.)

When ready to upload all data to computer, disable serial line sync mode, and then upload data and power down:

(Set RS-232 RX line high [3-10 VDC] for 1-1000 milliseconds. SBE 48 takes sample and stores data in memory)  
(Select *Send 5 second break* in Communications menu to disable serial line sync mode.)

(Press Enter key to get S> prompt.)

```
S>DS      (to verify SBE 48 is communicating)
```

(Click Upload on Toolbar – program leads you through screens to define data to be uploaded and where to store it)  
S>**QS**

## Baud Rate and Cable Length

### Notes:

- Set **TxRealTime=Y** to transmit real-time data for autonomous sampling or serial line sync mode.
- Set baud rate with **Baud=**. See *Command Descriptions* in *Section 4: Deploying and Operating SBE 48* for command details.

The length of cable that the SBE 48 can drive for transmitting real-time data is dependent on the baud rate. The allowable combinations are:

Maximum Cable Length (meters)	Maximum Baud Rate
800	1200
400	2400
200	4800
100	9600
50	19200
25	38400

If acquiring real-time data, click Capture on SEATERM's Toolbar before you begin sampling. The data displayed in SEATERM will be saved to the designated file. Process the data as desired. Note that this real-time data file **cannot be processed by Plot39 or SBE Data Processing, as it does not have the required headers and format.** To process data with Plot39 or SBE Data Processing, upload the data from the SBE 48's memory.

## Command Descriptions

This section describes commands and provides sample outputs. See *Appendix III: Command Summary* for a summarized command list.

When entering commands:

- Input commands to the SBE 48 in upper or lower case letters and register commands by pressing the Enter key.
- The SBE 48 sends `? CMD` if an invalid command is entered.
- If the system does not return an `S>` prompt after executing a command, press the Enter key to get the `S>` prompt.
- If a new command is not received within 2 minutes after the completion of a command, the SBE 48 returns to the quiescent (sleep) state to prevent exhaustion of its battery.
- If in quiescent state, re-establish communications by clicking Connect on the Toolbar or pressing the Enter key to get an `S>` prompt.

**Status Command****DS**

Display status and setup parameters.  
Equivalent to Status on Toolbar.

List below includes, where applicable, command used to modify parameter.

- firmware version, serial number, date and time [**MMDDYY=** and **HHMMSS=**]
- input power voltage
- logging status (logging not started, logging data, not logging: waiting to start at ... , not logging: received stop command, not logging: low battery, or unknown status)
- sample interval time [**Interval=**]
- number of samples to average (running average) [**NAvg=**]
- number of samples in memory, available sample space in memory
- serial line sync mode status [**SyncMode=**]
- real-time output status [**TxRealTime=**]
- binary upload includes time? [**BinaryTime=**]
- current temperature

*Example:* (user input in bold, command used to modify parameter in parentheses).

S>>**DS**

SBE48 V 2.0 SERIAL NO. 4355 24 Jul 2008 08:49:08

[**MMDDYY=** and **HHMMSS=**]

battery voltage = 7.5

logging not started

sample interval = 20 seconds

[**Interval=**]

number of samples to average = 60

[**NAvg=**]

samplenumber = 89, free = 4699778

serial sync mode disabled

[**SyncMode=**]

real-time output disabled

[**TxRealTime=**]

binary upload includes time

[**BinaryTime=**]

temperature = 19.48 deg C

## Setup Commands

**Notes:**

- **DDMMYY=** and **MMDDYY=** are equivalent. Either can be used to set the date.
- **Always set both date and then time.** If a new date is entered but not a new time, the new date will not be saved. If a new time is entered without first entering a new date, the date will reset to the last date it was set for with **MMDDYY=** or **DDMMYY=**.
- If the battery has been removed, date and time must be reset.
- If the SBE 48 is logging or waiting to start logging (**StartLater** command has been set), it will not allow the user to reset date or time.

**Note:**

The SBE 48's baud (set with **Baud=**) must be the same as SEATERM's baud (set in Configure menu).

**Notes:**

- **TxRealTime=** applies to autonomous (continuous or interval sampling) and serial line sync mode.
- To capture real-time data to a file, do this *before* starting logging:
  - A. Click Toolbar's Capture button.
  - B. Enter desired file name in dialog box. *Capture* status displays in status bar at bottom of screen.

**Note:**

See *Sampling Modes* for details on serial line synchronization.

**Note:**

**Do not send SampleNum=0 until all data has been uploaded.** **SampleNum=0** does not delete data; it just resets the data pointer. **If you accidentally send this command before uploading,** see *Memory in Appendix I: Functional Description* for a discussion of how to recover the data.

**MMDDYY=mmddyy**

Set real-time clock month, day, year. Must be followed by **HHMMSS=** to set time.

**DDMMYY=ddmmyy**

Set real-time clock day, month, year. Must be followed by **HHMMSS=** to set time.

**HHMMSS=hmmss**

Set real-time clock hour, minute, second.

*Example:* Set current date and time to 10 January 2009 12:00:00 (user input in bold).

S>**MMDDYY=011009**

S>**HHMMSS=120000**

or

S>**DDMMYY=100109**

S>**HHMMSS=120000**

**Baud=x**

x= baud rate (1200, 2400, 4800, 9600, 19200, 38400). Default 9600.

**NAvg=x**

x= number of scans in running average (1 - 120). Running average is reset to 0 when **StartNow** or **StartLater** is sent.

**TxRealTime=x**

x=Y: Output real-time data to computer. Data is transmitted immediately after it is sampled. **This does not affect storing data to FLASH memory, but slightly increases current consumption and increases amount of time needed to sample (and then transmit) data.**

x=N: Do not.

**SyncMode=x**

x=Y: Enable Serial Line Sync Mode. When RS-232 RX line is high (3-10 VDC) for 1 to 1000 milliseconds, SBE 48 takes a sample, stores data in FLASH memory, transmits real-time data (if **TxRealTime=Y**), and powers down.

x=N: Do not.

**SampleNum=x**

x= sample number for first sample when sampling begins. After all previous data has been uploaded from SBE 48, set sample number to 0 before starting to sample to make entire memory available for recording. If not set to 0, data will be stored after last recorded sample.

**QS**

Quit session and place SBE 48 in quiescent (sleep) state. Main power is turned off. Autonomous sampling and memory retention are unaffected, with one exception: If **Interval=0** (continuous sampling), do not send **QS** after sending **StartNow** (**QS** puts SBE 48 to sleep, preventing further logging).

**Autonomous Sampling (Logging) Commands****Note:**

If the SBE 48 is logging data and the voltage is less than 6.25 volts for ten consecutive scans, the SBE 48 halts logging and sets the logging status to low battery.

Autonomous sampling commands direct the SBE 48 to sample data at pre-programmed intervals and store the data in its FLASH memory.

**Note:**

Sampling time shown does not include time to transmit real-time data, which is dependent on baud rate.

Time required to transmit data =  
(# of characters \* 10 bits/character) / baud

This corresponds to 0.28 seconds at 1200 baud to 0.01 seconds at 38400 baud.

**Interval=x**

**x**= interval (seconds) between samples (0, or 3 to 32767). When commanded to start sampling with **StartNow** or **StartLater**, SBE 48 takes a sample, stores data in FLASH memory, transmits real-time data (if **TxRealTime=Y**), and powers down at **x** second intervals.

If **x=0**, SBE 48 samples continuously without powering down between samples. Approximate interval between samples:

Output	Time (seconds)
Not real-time ( <b>TxRealTime=N</b> )	0.80
Real-time ( <b>TxRealTime=Y</b> )	1.00

**Note:**

If **Interval=0** (continuous sampling), do not send **QS** after sending **StartNow**. **QS** puts the SBE 48 to sleep, preventing further logging.

**StartNow**

Start logging now. Running average is reset to 0. Data is stored in FLASH memory. Data is transmitted real-time if **TxRealTime=Y**.

**StartMMDDYY=mmddyy**

Set delayed logging start month, day, year. Must be followed by **StartHHMMSS=** to set delayed start time.

**Note:**

**StartDDMMYY=** and **StartMMDDYY=** are equivalent. Either can be used to set the delayed start date.

**StartDDMMYY=ddmmyy**

Set delayed logging start day, month, year. Must be followed by **StartHHMMSS=** to set delayed start time.

**StartHHMMSS=hmmss**

Set delayed logging start hour, minute, second.

**StartLater**

Start logging at time set with delayed start date and time commands. Running average is reset to 0. Data is stored in FLASH memory. Data is transmitted real-time if **TxRealTime=Y**.

**Notes:**

- After receiving **StartLater**, the SBE 48 displays not logging: waiting to start in reply to **DS**. Once logging has started, the **DS** reply indicates logging data.
- If the delayed start time has already passed when **StartLater** is received, the SBE 48 executes **StartNow**.

*Example:* Program SBE 48 to start logging on 20 January 2009 12:00:00 (user input in bold).

```
S>STARTMMDDYY=012009
S>STARTHHMMSS=120000
S>STARTLATER
```

or

```
S>STARTDDMMYY=200109
S>STARTHHMMSS=120000
S>STARTLATER
```

**Autonomous Sampling (Logging) Commands** *(continued)*

<b>SA</b>	Transmit running average of temperature data.
<b>SAQS</b>	Transmit running average of temperature data, and <b>turn power off</b> (put SBE 48 in quiescent state).
<b>Stop</b>	Stop logging (started with <b>StartNow</b> or <b>StartLater</b> ) or stop waiting to start logging (if <b>StartLater</b> was sent but logging has not begun yet). Press Enter key to get S> prompt before entering <b>Stop</b> . <b>Stop</b> must be sent before uploading data using Upload on the Toolbar, Upload Data in the Data menu, or <b>DDb,e</b> or <b>DBb,e</b> .

**Note:**

You may need to send **Stop** several times to get the SBE 48 to respond. This is most likely to occur if sampling continuously or with a small **Interval** and transmitting real-time data (**TxRealTime=Y**).

**Polled Sampling Commands**

These commands are used by an external controller to request a sample from the SBE 48.

<b>TS</b>	Take sample and transmit converted data. Data is <b>not</b> stored in FLASH memory. Do not send if SBE 48 is logging data.
<b>TSR</b>	Take sample and transmit raw data. Data is <b>not</b> stored in FLASH memory. Do not send if SBE 48 is logging data.
<b>SLT</b>	Transmit converted data from last sample from buffer, and then take new sample. Data is <b>not</b> stored in FLASH memory. Do not send if SBE 48 is logging data.
<b>SLTR</b>	Transmit raw data from last sample from buffer, and then take new sample. Data is <b>not</b> stored in FLASH memory. Do not send if SBE 48 is logging data.
<b>TSS</b>	Take sample, <b>store in FLASH memory</b> , transmit converted data, and <b>turn power off</b> . Do not send if SBE 48 is logging data.
<b>TSSOn</b>	Take sample, <b>store in FLASH memory</b> , and transmit converted data. Do not send if SBE 48 is logging data.
<b>SL</b>	Transmit converted data from last sample from buffer.

**Note:**

The SBE 48 has a buffer that stores the most recent data sample. Unlike data in the FLASH memory, data in the buffer is erased upon removal or failure of power.

---

**Data Upload Commands**

---

Send **Stop** before uploading data.

*ASCII Upload:***DDb,e**

Upload data **in ASCII** from scan **b** to scan **e**. First scan is number 1. If **DDb** is sent, only scan **b** is uploaded. If **DD** is sent, all scans in memory are uploaded.

As data uploads, the screen first displays `start time =`, `sample interval =`, and `start sample number =`. These are start time, sample interval, and starting sample number for the last set of logged data, which can be useful in determining what data to review.

**Notes:**

- Manually entering **DDb,e** or **DBb,e** does not produce data with the required header information for processing by Plot39 or SBE Data Processing. **Use Upload on the Toolbar or Upload Data in the Data menu to upload data that will be processed by Plot39 or SBE Data Processing.** SEATERM checks the setting on the Upload Settings tab in the Configuration dialog box to determine whether to upload in ASCII or binary format.
- To save data to a file, click Capture on the Toolbar before entering **DDb,e** or **DBb,e**.
- See *Data Output Formats* after these *Command Descriptions*.

*Example:* Upload data from memory (user input in bold).

(Click Capture on Toolbar and enter the desired filename in the dialog box before beginning upload.)

```
S>DD1 , 200    (Upload scans 1 through 200)
S>DD1         (Upload scan 1)
S>DD          (Upload all scans in memory)
```

*Binary Upload:*

Binary upload, useful for large data sets, is faster than ASCII upload.

SEATERM uploads the data in binary and then converts to ASCII engineering units, **resulting in a .asc file with the same format as from an ASCII upload**. SEATERM uses the following relationships to convert the binary data back to ASCII engineering units:

$$t = (T / \text{tscale}) - \text{toffset}$$

$$\text{time (binary)} = \text{seconds since 1980}$$

where

- `tscale` and `toffset` are factory-programmed into the SBE 48
- `T` is a binary representation of temperature
- `t` is temperature in ASCII engineering units

**DBb,e**

Upload data **in binary** from scan **b** to scan **e**. First scan is number 1. If **DBb** is sent, only scan **b** is uploaded. If **DB** is sent, all scans in memory are uploaded.

As data uploads, screen first displays `start time =`, `sample interval =`, and `start sample number =`. These are start time, sample interval, and starting sample number for last set of logged data, which can be useful in determining what data to review.

*Example:* Upload data from memory (user input in bold).

(Click Capture on Toolbar and enter desired filename in dialog box before beginning upload.)

```
S>DB1 , 200    (Upload scans 1 through 200)
S>DB1         (Upload scan 1)
S>DB          (Upload all scans in memory)
```



**Data Upload** Commands (continued)**Note:**

**BinaryTime=** has no effect on the standard ASCII upload.

**BinaryTime=x**

**Applies to binary data upload only.**

**x=Y:** Upload date and time for every scan from memory.

**x=N:** Upload date and time from memory only for scan at beginning of each block of data (350 scans/block), reducing time required for upload. SEATERM uses **Interval=** to calculate and insert date and time for each scan within block. If SBE 48 did not sample at correct interval, any discrepancy will be apparent by comparing *calculated* time for last scan in a data block to *uploaded* time for first scan in following data block.

**Do not set BinaryTime=N if Interval=0 (continuous sampling);** SEATERM will insert **same** date and time for every scan in block.

**\*DB**

Display binary upload parameters.

Each parameter is separated by a comma and a space. List below includes, where applicable, command used to modify parameter.

- Sample interval time [**Interval=**]
- Type

Type	BinaryTime=
0	N
2	Y

- Tscale and toffset - factory-programmed parameters used to convert binary data from SBE 48 back to ASCII engineering units

---

**Testing Commands**

---

Data obtained with these commands is **not** stored in FLASH memory.

**TT** Measure temperature for 100 samples or until Esc key is pressed, output converted data.

**TTR** Measure temperature for 100 samples or until Esc key is pressed, output raw data.

---

**Calibration Coefficients Commands**

---

**Notes:**

- Date shown is when calibration was performed. Calibration coefficients are initially factory-set and should agree with Calibration Certificates shipped with SBE 48.
- See individual Coefficient Commands below for definitions of the data in the example.

**DC** Display calibration coefficients.  
Equivalent to Coefficients on Toolbar.

*Example:* Display coefficients for an SBE 48 (user input in bold).

```

S>DC
SBE48 v 2.0    0916
temperature:   28-jul-09
TA0 = -9.420702e-05
TA1 =  2.937924e-04
TA2 = -3.739471e-06
TA3 =  1.909551e-07

```

The individual Coefficient Commands listed below are used to modify a particular coefficient or date:

**Note:**

F = floating point number  
S = string with no spaces

**TCalDate=S**

**S**= Temperature calibration date.

**TA0=F**

**F**= Temperature A0.

**TA1=F**

**F**= Temperature A1.

**TA2=F**

**F**= Temperature A2.

**TA3=F**

**F**= Temperature A3.

## Data Output Formats

The SBE 48 transmits data in engineering units (except in response to **TSR** and **SLTR**, which request raw data). The exact format of the output varies, as described below.

### Notes:

- Each line of output is followed by a carriage return and line feed.
- Leading zeros for temperature output are suppressed, except for one zero to the left of the decimal point (for example, a temperature of 0.1034).

- Output to SEATERM after Sending Polled Sampling Command (**TS, SL, SLT, TSS, TSSOn**) -  
ttt.tttt, dd mmm yyyy, hh:mm:ss
- Output to SEATERM if Transmitting Real-Time Data (**TxRealTime=Y**) -  
# ttt.tttt, dd mmm yyyy, hh:mm:ss
- Output to SEATERM after Manually Sending Data Upload Command (**DDb,e**) -  
ttt.tttt, dd mmm yyyy, hh:mm:ss
- Output to SEATERM after Manually Sending Binary Data Upload Command (**DDb,e**) - not usable
- Output to **.asc** file after Sending Data Upload Command with Upload on Toolbar or Upload Data in Data menu -  
ttt.tttt, dd mmm yyyy, hh:mm:ss  
Note: This applies to ASCII as well as binary upload

Where:

**t** = temperature (degrees Celsius, ITS-90)

**hh:mm:ss** = hour, minute, second

**dd mmm yyyy** = day, month, year

The month is a 3-character alphabetic abbreviation (jan, feb, mar, etc.)

## Setup for Deployment

1. If not providing external power, install a new battery or ensure the existing battery has enough capacity to cover the intended deployment. See *Section 2: Description of SBE 48* for battery endurance specifications and *Section 5: Routine Maintenance and Calibration* for details on battery replacement.
2. Program the SBE 48 for the intended deployment (see *Section 3: Preparing SBE 48 for Deployment* for connection information; see information in this section on commands and sampling modes):
  - A. Ensure all data has been uploaded, and then set **SampleNum=0** to make the entire memory available for recording. If **SampleNum** is not reset to 0, data will be stored after the last recorded sample.
  - B. Set the date and then time.
  - C. Establish the setup and sampling parameters.
  - D. Use **one** of the following sequences to initiate logging:
    - **StartNow** to start logging now, taking a sample every **Interval=** seconds.
    - **StartMMDDYY=**, **StartHHMMSS=**, and **StartLater** to start logging at the specified date and time, taking a sample every **Interval=** seconds.
    - **SyncMode=Y** to place the SBE 48 in serial line sync mode, so that a simple pulse on the RS-232 line will initiate a sample.

### Notes:

- If the battery has been removed, date and then time must be reset.
- **It is always necessary to set both date and then time.**

### Note:

If **Interval=0**, the SBE 48 samples continuously, without powering down between samples.

## Deployment

### CAUTION:

**Do not use WD-40** or other petroleum-based lubricants, as they will damage the connectors.

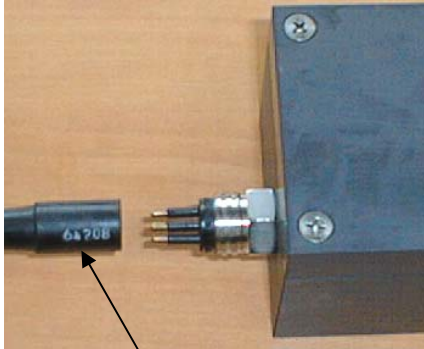

I/O cable connector

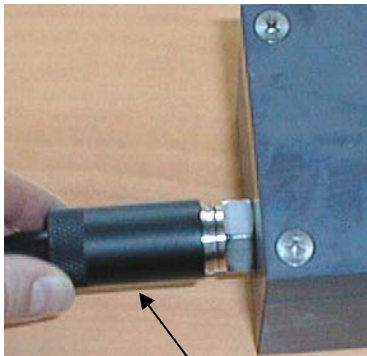

Locking sleeve

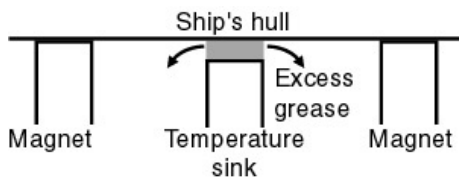
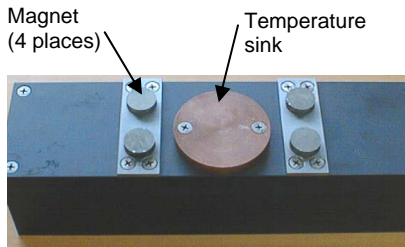

1. Install the I/O cable connector:
  - A. Lightly lubricate the sides of the rubber prongs on the SBE 48 bulkhead connector with silicone grease (DC-4 or equivalent).
  - B. Install the cable connector, aligning the holes with the five pins on the SBE 48's bulkhead connector.
  - C. Place the locking sleeve over the connector. Tighten the locking sleeve finger tight only. **Do not overtighten the locking sleeve and do not use a wrench or pliers.**
  - D. Connect the I/O cable connector to your computer's serial port. A 9-to-25 pin adapter is supplied for use if your computer has a 25-pin serial port.
  - E. Connect the I/O cable connector's red (+) and black (-) wires to a power supply (8 - 16 VDC).
  
2. Generously coat the temperature sink with heat sink grease.
  
3. Mount the SBE 48 on the inside of the ship's hull, using the magnets. Excess heat sink grease should squeeze out the side of the temperature sink.
  - **If excess grease does not squeeze out the side, the temperature sink may not be in good contact with the hull.** Remove the SBE 48 from the hull, apply more heat sink grease, and remount.

## Uploading Data

**Note:**

While uploading data, `Warning: Low Battery Voltage` may be displayed. Follow **one** of these procedures to continue uploading:

- Connect power to the I/O connector red and black wires, to provide external power. This prevents loss of clock information and data in the 256 byte cache buffer. Once external power is in place, you can replace the internal battery without loss of clock information or data.
- Remove the internal battery and install a new one. The momentary loss of power resets the clock, preventing analysis of any clock drift, and erases the 256 byte cache buffer data (most recently recorded data, corresponding to 36 data samples).

Note that all but the most recent data is stored in non-volatile FLASH memory, which is not affected by loss of power. See *Section 5: Routine Maintenance and Calibration* for replacement of the internal battery. See *Memory* in *Appendix I: Functional Description* for a discussion of the cache buffer.

1. If not already installed, install the I/O cable connector and connect it to an external power supply and to your computer's serial port. See *Power and Communications Test* in *Section 3: Preparing SBE 48 for Deployment*.

2. Double click on `SeaTerm.exe`. The display shows the main screen.

**Note:**

Set up **Upload Settings**, **Header Information**, and/or **Header Form** (Steps 3 through 5):

- The first time you upload data, and
- If you want to change upload or header parameters.

3. In the Configure menu, select **SBE 39**. Click on the Upload Settings tab. The dialog box looks like this:

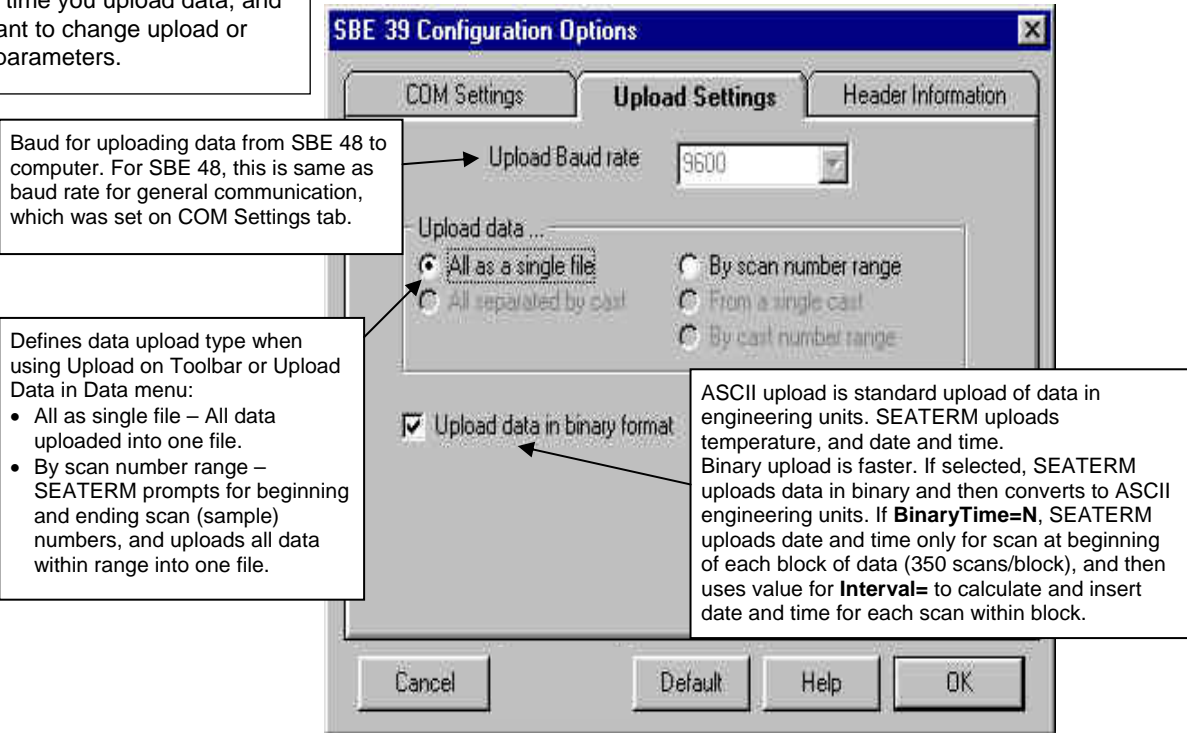

Make the selection for Upload Settings.

4. Click on the Header Information tab. The dialog box looks like this:

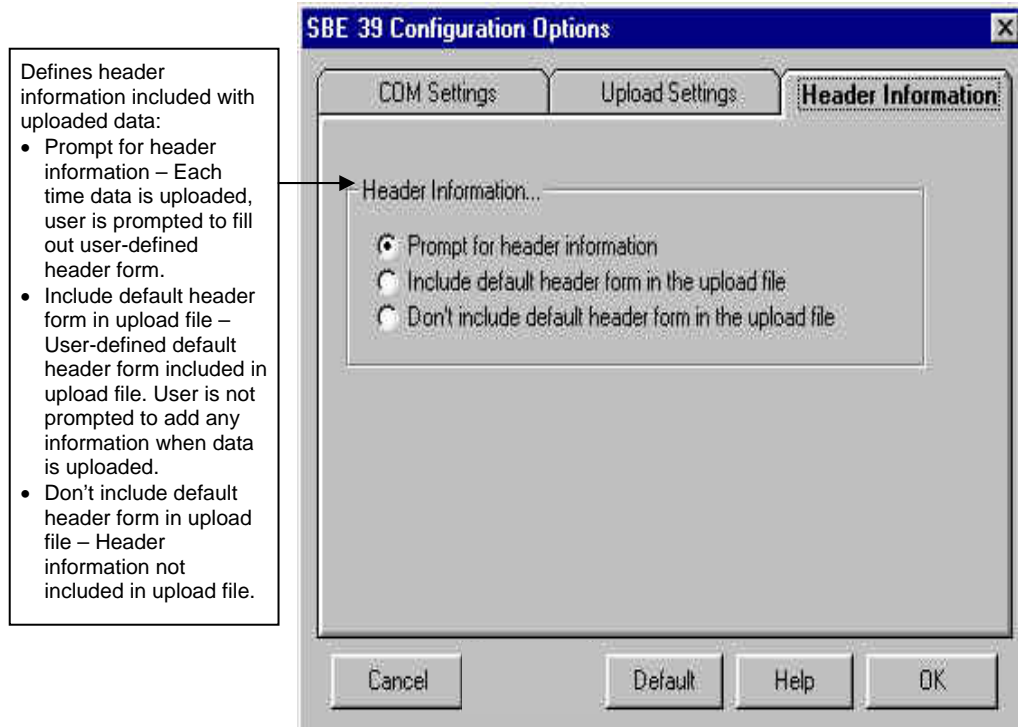

Select the desired header information option. Click OK to save the settings.

5. In the Configure menu, select Header Form to customize the header. The dialog box looks like this (default prompts are shown):

The entries are free form, 0 to 12 lines long. This dialog box establishes:

- the header prompts that appear for the user to fill in when uploading data, if *Prompt for header information* was selected in the Configuration Options dialog box (Step 4)
- the header included with the uploaded data, if *Include default header form in upload file* was selected in the Configuration Options dialog box (Step 4)

Enter the desired header/header prompts. Click OK.

6. Click Connect on the Toolbar to begin communications with the SBE 48. The display looks like this:

```
SBE 48
S>
```

This shows that correct communications between the computer and the SBE 48 has been established.

If the system does not respond as shown above:

- Click Connect again.
  - Check cabling between the computer and the SBE 48.
  - Verify the correct instrument (**SBE 39**) was selected and the COM settings were entered correctly in the Configure menu.
7. If sampling autonomously, command the SBE 48 to stop logging by pressing the Enter key and sending **Stop**.

8. Display SBE 48 status information by clicking Status on the Toolbar. The display looks like this:

```
SBE 48 V 2.0 SERIAL NO. 0916 08 Aug 2008 08:49:09
battery voltage = 7.5
not logging: received stop command
sample interval = 30 seconds
number of samples to average = 60
samplenumber = 10000, free = 4689867
serial sync mode disabled
real-time output disabled
binary upload includes time
temperature =19.48 deg C
```

9. Click Upload on the Toolbar to upload stored data. SEATERM responds as follows:

- A. SEATERM sends the status (**DS**) command, displays the response, and writes the command and response to the upload file. **DS** provides you with information regarding the number of samples in memory as well as the instrument setup.
- B. **If you selected *By scan number range in the Configuration Options dialog box (Configure menu)*** – a dialog box requests the range. Enter the desired value(s), and click OK.
- C. SEATERM sends the calibration coefficients (**DC**) command, displays the response, and writes the command and response to the upload file. **DC** displays the SBE 48's calibration coefficients.
- D. **If you selected *Prompt for header information in the Configuration Options dialog box (Configure menu)*** – a dialog box with the header form appears. Enter the desired header information, and click OK.
- E. In the Open dialog box, enter the desired upload file name and click OK. The upload file has a .asc extension.
- F. SEATERM sends the data upload command (**DDb,e** or **DBb,e**, depending on your selection of ASCII or binary upload on the Upload Settings tab of the Configuration Options dialog box).
- G. When the data has been uploaded, SEATERM shows the S> prompt.

**Note:**

Binary upload is supported only for SBE 48 with firmware version 2.0 and later. SEATERM automatically checks the firmware version before it begins upload; if you selected binary upload but the SBE 48 firmware does not support it, SEATERM performs an ASCII upload instead.



10. Ensure all data has been uploaded from the SBE 48 by reviewing the data. Sea-Bird provides two options for reviewing/processing the data:
- A. Use **Plot39** to plot the ASCII (.asc) data (see *Appendix II: PLOT39 Data Plotting Program* for details), **OR**
  - B. Use **SEATERM's Convert** utility to convert the .asc file to a .cnv file that can be used by SBE Data Processing. SBE Data Processing includes many post-processing modules; **the only modules applicable to the SBE 48 include ASCII OUT and Sea Plot.**
    - 1) In SEATERM, click Convert on the Toolbar. The Convert dialog box appears.
      - Enter the input (.asc) file name and the desired output (.cnv) file name; file names must include the path.
      - In processing the data, date and time is converted to Julian Day with five significant digits. As the default, Convert does not reset the Julian Day to 0 when rolling over from December 31 to January 1. If desired, click *Start new year at Julian time 0* to reset the Julian Day to 0 on January 1.
      - The *Convert pressure to depth* box is not applicable to the SBE 48 - an SBE 48 does not have a pressure sensor.
    - 2) After the data is converted, use SBE Data Processing to process the .cnv data. See the software manual on CD-ROM or Help files for details.

**Notes:**

To prepare the SBE 48 for re-deployment:

1. After all data has been uploaded, send **SampleNum=0**. If this command is not sent, new data will be stored after the last recorded sample, preventing use of the entire memory capacity.
2. Do *one* of the following:
  - Send **QS** to put the SBE 48 in quiescent (sleep) state until ready to redeploy. Leaving the SBE 48 with the battery in place and in quiescent state retains the date and time. The quiescent current is only 10 microamps, so the battery can be left in place without significant loss of capacity.
  - Use **StartNow** to begin logging immediately.
  - Set a time and date for logging to start using **StartMMDDYY=** or **StartDDMMYY=**, **StartHHMMSS=**, and **StartLater**.

# Section 5: Routine Maintenance and Calibration

This section reviews corrosion precautions, sensor calibration, and replacement of the battery. The SBE 48's accuracy is sustained by the care and calibration of the sensor and by establishing proper handling practices.

---

## Corrosion Precautions

When used as described in this manual, the SBE 48 is not exposed to seawater. No corrosion precautions are required.

---

## Sensor Calibration

Sea-Bird sensors are calibrated by subjecting them to known physical conditions and measuring the sensor responses. Coefficients are then computed, which may be used with appropriate algorithms to obtain engineering units. The temperature sensor on the SBE 48 is supplied fully calibrated, with coefficients printed on the Calibration Certificate (see back of manual). These coefficients have been stored in the SBE 48's EEPROM.

We recommend that the SBE 48 be returned to Sea-Bird for calibration.

The primary source of temperature sensor calibration drift is the aging of the thermistor element. Sensor drift will usually be a few thousandths of a degree during the first year, and less in subsequent intervals. Sensor drift is not substantially dependent upon the environmental conditions of use, and — unlike platinum or copper elements — the thermistor is insensitive to shock.

## Replacing Battery

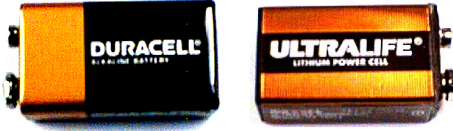

Sea-Bird ships the SBE 48 with a 9-volt lithium battery installed. Leave the battery in place when storing the SBE 48 (quiescent current is only 10 microamps). If the SBE 48 is supplied with external power, the battery only powers the real-time clock and should last for five to ten years. However, **replace the battery yearly to prevent battery leakage** (which could damage the SBE 48).

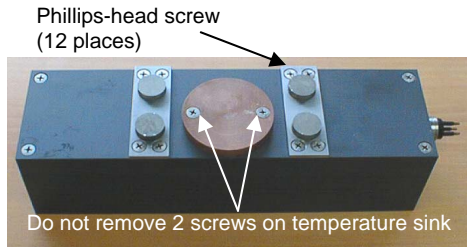

Follow the instructions below to change the battery. Use a 9-volt lithium or alkaline battery. See *Shipping Precautions* in *Section 1: Introduction* for details on shipping lithium batteries.

1. Remove the cover and electronics from the housing:
  - A. Wipe the outside of the cover and housing dry, being careful to remove any water at the seam between them.
  - B. Remove the twelve Phillips-head screws (around the perimeter of the cover) that secure the cover to the SBE 48. Carefully remove the cover and electronics - the connector is electrically connected to the electronics with a Molex connector.
  - C. Remove any water from the cover O-ring and mating surfaces with a lint-free cloth or tissue.

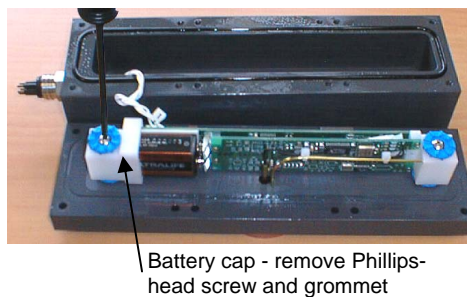

2. Replace the battery:
  - A. Remove the Phillips-head screw and grommet on the white battery cap.

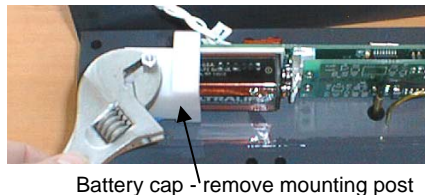

- B. Remove the mounting post on the battery cap.

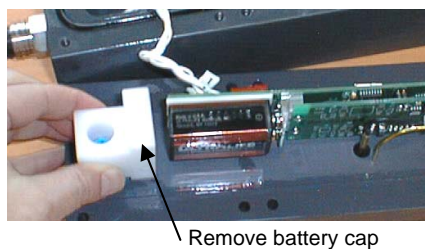

- C. Pull the battery cap off the battery.
  - D. Unsnap the old battery and replace with the new one. (The circuit is reverse polarity protected. Accidental contact will not harm the SBE 48).
  - E. Reinstall the battery cap with grommets (top and bottom), mounting post, and Phillips-head screw.

### Note:

Before delivery, a desiccant package is placed in the housing, and the electronics chamber is filled with dry Argon gas. These measures help prevent condensation. To ensure proper functioning:

1. Install a new desiccant bag each time you open the housing. If a new bag is not available, see *Application Note 71: Desiccant Use and Regeneration (drying)*.
2. If possible, dry gas backfill each time you open the housing. If you cannot, wait at least 24 hours before redeploying, to allow the desiccant to remove any moisture from the housing.

3. Reinstall the electronics and cover:
  - A. Remove the old desiccant bag and replace with a new one.
  - B. Remove any water from the O-ring and mating surfaces with a lint-free cloth or tissue. Inspect the O-ring and mating surfaces for dirt, nicks, and cuts. Clean as necessary. Apply a light coat of O-ring lubricant (Parker Super O Lube) to O-ring and mating surfaces.
  - C. Carefully fit the cover onto the housing.
  - D. Install the twelve Phillips-head screws to secure the cover to the housing.

# Glossary

**Battery** – 9-volt lithium or alkaline transistor battery

**Convert** – Toolbar button in SEATERM to convert ASCII (.asc) data uploaded from the SBE 48 with SEATERM to .cnv format. When converted to .cnv format, SBE Data Processing can be used to analyze and display data.

**PCB** – Printed Circuit Board.

**Plot39** – Sea-Bird’s Win 95/98/NT/2000/XP software for plotting SBE 48 (and SBE 39) data.

**SBE 48** – High-accuracy temperature recorder.

**SBE Data Processing** – Sea-Bird’s Win 2000/XP data processing software, which calculates and plots temperature and derived variables. The only modules in SBE Data Processing that can be used with SBE 48 .cnv data are ASCII Out and Sea Plot.

**Scan** – One data sample containing temperature and date and time.

**SEASOFT-Win32** – Sea-Bird’s complete Win 2000/XP software package, which includes software for communication, real-time data acquisition, and data analysis and display. SEASOFT-Win32 includes **SEATERM**, SeatermAF, SEASAVE, **SBE Data Processing**, and **Plot39**.

**SEATERM** – Sea-Bird’s Win 95/98/NT/2000/XP software used to communicate with the SBE 48. The SBE 48 is not available in SEATERM’s Configure menu; **select the SBE 39 as the instrument type**.

# Appendix I: Functional Description

## Sensor

The SBE 48 includes the same temperature sensor element (pressure-protected thermistor) previously employed in Sea-Bird's modular SBE 3 sensor, SEACAT family, and SBE 39.

---

## Sensor Interface

Temperature is acquired by applying an AC excitation to a hermetically sealed VISHAY reference resistor and an ultra-stable aged thermistor with a drift rate of less than 0.002°C per year. A 24-bit A/D converter digitizes the outputs of the reference resistor and thermistor. AC excitation and ratiometric comparison using a common processing channel avoids errors caused by parasitic thermocouples, offset voltages, leakage currents, and reference errors.

---

## Real-Time Clock

To minimize power and improve clock accuracy, a temperature-compensated crystal oscillator (TCXO) is used as the real-time-clock frequency source. The TCXO is accurate to  $\pm 1$  minute per year (0 °C to 40 °C).

---

## Memory

### Data

The SBE 48 has a 64 MB FLASH memory for data storage (32,900,000 bytes usable). FLASH memory is non-volatile, and data in the memory is not lost as a result of depletion or removal of the battery. Because FLASH is written to a *page* (256 bytes) at a time, data is first accumulated in a 256-byte cache buffer. When the cache is full, its contents are transferred to FLASH memory. The cache is volatile, and thus depends on battery power. That is why an SBE 48 with depleted battery will lose its most recently stored data unless an external power supply is used (see *Uploading Data* in *Section 4: Deploying and Operating SBE 48*).

The data upload process integrates the data from the FLASH memory and the cache. **SampleNum=** controls the memory pointers that manage this process. Setting **SampleNum=0** resets the pointer in the FLASH memory and in the cache memory, causing the SBE 48 to overwrite existing data. It is important not to change **SampleNum=** until all data has been uploaded.

If **SampleNum** is inadvertently set to 0 before data is uploaded, and you wish to upload data, the following conditions apply:

<b>Was additional data logged after SampleNum= was changed?</b>	<b>User then returns SampleNum= to:</b>	<b>Description of Uploaded Data</b>
<b>No</b>	Original value	All data (data in FLASH as well as data in cache) uploads correctly.
<b>No</b>	Estimated value larger than original value	All data in FLASH uploads correctly. Data in cache is corrupted (minimum of 0 and maximum of 36 scans).
<b>Yes &lt; 256 bytes of new data (36 scans)</b>	Original value	Old data in FLASH uploads correctly. Old data in cache is corrupted. First scan of new data in cache is corrupted; remaining scans of new data in cache upload correctly.
<b>Yes &gt; 256 bytes of new data (36 scans)</b>	Original value	Old data in FLASH is overwritten with new data. Old data in cache is corrupted. If new data set is smaller than old set, a portion of old set can be recovered; scan bridging old and new data is corrupted. First scan of new data in cache is corrupted; remaining scans of new data in cache upload correctly.

### Timekeeping

Time is stored in volatile memory. If power is removed, the clock resets to 1 January 1980. Upon restoration of power, the clock resumes normal operation.

### Settings

Calibration coefficients and setup and operating parameters (**Baud=**, **SampleNum=**, **Interval=**, etc.) are written to EEPROM and are non-volatile. These settings do not change if power is removed.

# Appendix II: Plot39 Data Plotting Program

## Notes:

- Pressure plot shown in the figure is not applicable to the SBE 48.
- Help files provide detailed information on the use of Plot39.

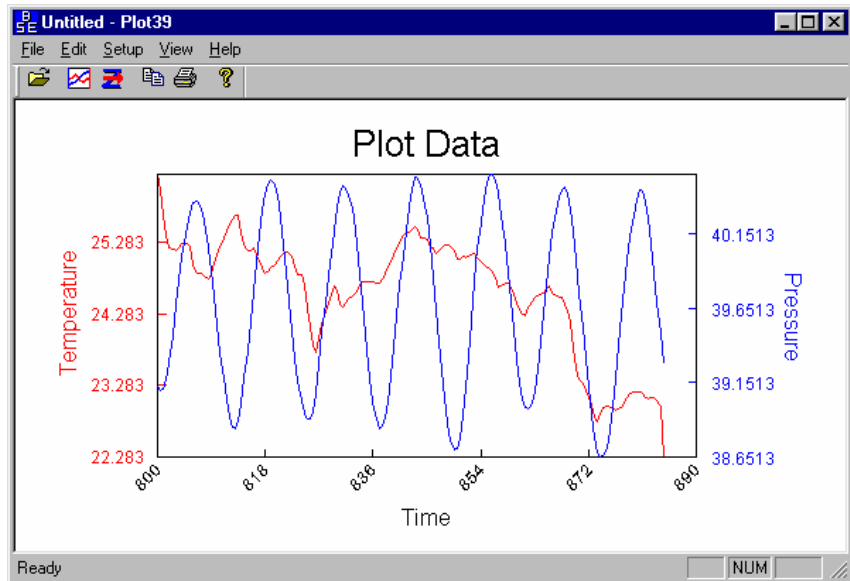

Plot39 is used to plot ASCII data (.asc file) that has been uploaded from the SBE 48. Plot39:

- Plots the data in color. The plot can be saved as a graphic file for presentation.
- Improves display speed with data culling. Plot39 plots every Nth data value, where N is dependent on the number of data values to be displayed and the width of the display rectangle in pixels.
- Allows axis and font sizes to be easily changed.
- Allows a section of a plot to be magnified to reveal more detail.

If not already installed, install Plot39 and other Sea-Bird software programs on your computer using the supplied software CD:

1. Insert the CD in your CD drive.
2. Double click on **Seasoft-Win32.exe**.
3. Follow the dialog box directions to install the software.

The default location for the software is c:\Program Files\Sea-Bird. Within that folder is a sub-directory for each program. The installation program allows you to install the desired components. Install all the components, or just install Plot39 for now.

# Appendix III: Command Summary

**Note:**

See *Command Descriptions* in Section 4: *Deploying and Operating SBE 48* for detailed information and examples.

CATEGORY	COMMAND	DESCRIPTION
	<b>DS</b>	Display status and setup parameters.
<b>Setup</b>	<b>MMDDYY=mmddy</b>	Set real-time clock month, day, year. Must follow with <b>HHMMSS=</b> .
	<b>DDMMYY=ddmmy</b>	Set real-time clock day, month, year. Must follow with <b>HHMMSS=</b> .
	<b>HHMMSS=hmmss</b>	Set real-time clock hour, minute, second.
	<b>Baud=x</b>	x= baud rate (1200, 2400, 4800, 9600, 19200, 38400). Default 9600.
	<b>NAvg=x</b>	x= number of scans in running average (1 - 120).
	<b>TxRealTime=x</b>	x=Y: Output real-time data to computer. Does not affect storing data to memory, but slightly increases current consumption. x=N: Do not.
	<b>SyncMode=x</b>	x=Y: Enable Serial Line Sync Mode. When RS-232 RX line is high (3-10 VDC) for 1 - 1000 milliseconds, SBE 48 takes a sample, stores data in FLASH memory, transmits real-time data (if <b>TxRealTime=Y</b> ), and powers down. x=N: Do not.
	<b>SampleNum=x</b>	x= sample number for first sample when sampling begins. After all previous data has been uploaded, set to 0 before starting to log to make entire memory available for recording. If not reset to 0, data is stored after last sample.
	<b>QS</b>	Enter quiescent (sleep) state. Data logging and memory retention unaffected.
<b>Autonomous Sampling (Logging)</b>	<b>Interval=x</b>	x= interval (seconds) between samples (0, or 3 - 32767). When commanded to start sampling with <b>StartNow</b> or <b>StartLater</b> , SBE 48 takes sample, stores data in FLASH memory, transmits real-time data (if <b>TxRealTime=Y</b> ), and powers down at x second intervals. If x=0, SBE 48 samples continuously without powering down between samples.
	<b>StartNow</b>	Start logging now. Reset running average to 0.
	<b>StartMMDDYY=mmddy</b>	Delayed logging start: month, day, year. Must follow with <b>StartHHMMSS=</b> .
	<b>StartDDMMYY=ddmmy</b>	Delayed logging start: day, month, year. Must follow with <b>StartHHMMSS=</b> .
	<b>StartHHMMSS=hmmss</b>	Delayed logging start: hour, minute, second.
	<b>StartLater</b>	Start logging at delayed logging start time. Reset running average to 0.
	<b>SA</b>	Transmit running average of data.
	<b>SAQS</b>	Transmit running average of data, and <b>turn power off</b> .
	<b>Stop</b>	Stop logging or stop waiting to start logging. Press Enter key to get S> prompt before entering <b>Stop</b> . Must send <b>Stop</b> before uploading data.



CATEGORY	COMMAND	DESCRIPTION
<b>Polled Sampling</b>  *Do not send these commands if SBE 48 is logging data.	<b>TS *</b>	Take sample and transmit converted data. Data not stored in FLASH memory.
	<b>TSR *</b>	Take sample and transmit raw data. Data not stored in FLASH memory.
	<b>SLT *</b>	Transmit converted data from last sample from buffer, and then take new sample. Data not stored in FLASH memory.
	<b>SLTR *</b>	Transmit raw data from last sample from buffer, and then take new sample. Data not stored in FLASH memory.
	<b>TSS *</b>	Take sample, store data in FLASH memory, transmit converted data, and turn power off.
	<b>TSSOn *</b>	Take sample, store data in FLASH memory, and transmit converted data.
	<b>SL</b>	Transmit converted data from last sample from buffer.
<b>Data Upload</b>	<b>DDb,e</b>	Upload data in <b>ASCII</b> from scan <b>b</b> to scan <b>e</b> . Send <b>Stop</b> before sending <b>DDb,e</b> .
	<b>DBb,e</b>	Upload data in <b>binary</b> from scan <b>b</b> to <b>e</b> . Send <b>Stop</b> before sending <b>DBb,e</b> .
	<b>BinaryTime=x</b>	<b>Applies to binary data upload only.</b> <b>x=Y</b> : Upload date and time for every scan from memory. <b>x=N</b> : Upload date and time only for beginning scan in each data block; use <b>Interval=</b> to calculate and insert date and time for all other scans.
	<b>*DB</b>	Display binary upload parameters.
<b>Testing</b>	<b>TT</b>	Measure temperature for 100 samples or until Esc key is pressed, output converted data.
	<b>TTR</b>	Measure temperature for 100 samples or until Esc key is pressed, output raw data
<b>Coefficients</b> (F=floating point number; S=string with no spaces)  Date shown is when calibration was performed. Calibration coefficients are initially factory-set and should agree with Calibration Certificates shipped with SBE 48.	<b>DC</b>	Display calibration coefficients; all coefficients and date listed below are included. Use individual commands below to modify a particular coefficient or date.
	<b>TCalDate=S</b>	S=Temperature calibration date.
	<b>TA0=F</b>	F=Temperature A0.
	<b>TA1=F</b>	F=Temperature A1.
	<b>TA2=F</b>	F=Temperature A2.
	<b>TA3=F</b>	F=Temperature A3.

**Note:**  
Use Upload on the Toolbar or Upload Data in the Data menu to upload data that will be processed by Plot39 or SBE Data Processing. Manually entering the data upload command does not produce data with the required header information for processing by our software. This command is included here for reference for users who are writing their own software.

# Appendix IV: Replacement Parts

Part Number	Part	Application Description	Quantity in SBE 48
30845	Screw, 10-24 x 1 <sup>1</sup> / <sub>4</sub> " flat-head, Phillips-head, stainless steel	Secure cover to housing at corners and at magnet mounting bars	12
30144	Screw, 6-32 x 7/16" truss, Phillips-head, stainless steel	Secure Battery / PCB end caps	2
31109	Grommets	Isolate PCB from mounting posts	4
31111	Spacer, 6-32 x 1 <sup>3</sup> / <sub>8</sub> " hex, aluminum	Mounting post for Battery/PCB end caps	2
31121	O-ring, 2-263N674-70, Parker	Seal between cover and housing	1
22074	Battery, 9-volt lithium, UltraLife U9VL (standard)	Power SBE 48	1
22039	Battery, 9-volt alkaline, Duracell MN 1604 (optional)	Power SBE 48	1
801431	5-pin to 9-pin I/O cable with power leads, 2.4 m (8 ft) long	From SBE 48 to computer	1
171888	25-pin DB-25S to 9-pin DB-9P cable adapter	For use with computer with DB-25 connector	1

# Index

---

## A

About Sea-Bird · 4

---

## B

Batteries  
   endurance · 10  
   shipping precautions · 6  
 Battery · 8, 27  
   replacing · 35  
 Baud rate · 19

---

## C

Cable length · 19  
 Calibration · 34  
 Clock · 8, 37  
 Command summary · 40  
 Commands  
   autonomous sampling · 22  
   calibration coefficients · 26  
   data upload · 24  
   descriptions · 19  
   logging · 22  
   polled sampling · 23  
   setup · 21  
   status · 20  
   testing · 26  
 Communication defaults · 14  
 Connector · 9  
 Convert .asc to .cnv · 33  
 Corrosion precautions · 34

---

## D

Data output formats · 27  
 Data plotting · 39  
 Deployment  
   installation · 28  
   preparing for · 11  
   setup · 27  
 Description · 7  
 Desiccant · 35  
 Dimensions · 9

---

## F

Format  
   data output · 27  
 Functional description · 37

---

## G

Glossary · 36

---

## L

Limited liability statement · 2

---

## M

Maintenance · 34  
 Memory · 8, 37  
 Modes · *See* Sampling modes

---

## P

Parts  
   replacement · 42  
 Plot39 · 7, 11, 33, 39

---

## Q

Quick start · 4

---

## R

Replacement parts · 42

---

## S

Sample timing · 10  
 Sampling modes · 16  
   autonomous · 17  
   polled · 16  
   serial line sync · 18  
 SBE Data Processing · 7, 11, 33  
 SEASOFT-Win32 · 7, 11  
 SEATERM · 7, 11, 12, 29  
   main screen · 12  
   toolbar buttons · 13  
 Sensor · 8, 37  
 Shipping precautions · 6  
 Software · 7, 11  
 Specifications · 8  
 System description · 7

---

## T

Testing · 11

---

## U

Unpacking SBE 48 · 5  
 Uploading data · 29