

SBE 49 FastCAT

*Conductivity, Temperature, and Pressure Sensor
with RS-232 Interface*



*If deploying vertically, intended for deployment in orientation shown
(sensors at top) for proper pump operation*

User's Manual

Sea-Bird Electronics, Inc.
13431 NE 20th Street
Bellevue, Washington 98005 USA
Telephone: +1 425-643-9866
Fax: +1 425-643-9954
seabird@seabird.com
www.seabird.com

Manual Version #016, 03/18/14
Firmware Version 1.3a and later
Seasave V7 Version 7.23.2 and later
SBE Data Processing Version 7.23.2 and later



Limited Liability Statement

Extreme care should be exercised when using or servicing this equipment. It should be used or serviced only by personnel with knowledge of and training in the use and maintenance of oceanographic electronic equipment.

SEA-BIRD ELECTRONICS, INC. disclaims all product liability risks arising from the use or servicing of this system. SEA-BIRD ELECTRONICS, INC. has no way of controlling the use of this equipment or of choosing the personnel to operate it, and therefore cannot take steps to comply with laws pertaining to product liability, including laws which impose a duty to warn the user of any dangers involved in operating this equipment. Therefore, acceptance of this system by the customer shall be conclusively deemed to include a covenant by the customer to defend, indemnify, and hold SEA-BIRD ELECTRONICS, INC. harmless from all product liability claims arising from the use or servicing of this system.

Declaration of Conformity

Sea-Bird Electronics, Inc.
 13431 NE 20th Street, Bellevue, WA 98005 USA

DECLARATION OF CONFORMITY

Manufacturer's Name: Sea-Bird Electronics
Manufacturer's Address: 13431 NE 20th Street
 Bellevue, WA 98005, USA

The Authorized Representative located within the Community is:
 OTT MESSTECHNIK GmbH & Co.KG
 P.O.Box: 2140 / 87411 Kempten / Germany
 Ludwigstrasse 16 / 87437 Kempten
 Internet: <http://www.ott.com>
 Phone: +49 831 5617 – 100
 Fax: +49 831 5617 - 209

Device Description: Various Data Acquisition Devices and Sensors

Model Numbers:

3S	3F	3plus	4C	4M	5T	5P	5M	7
8	9plus	11plus	14	16plus V2	16plus-IM V2		17plus V2	18
19plus V2	21	25plus	26plus	27	29	32	32C	32SC
33	35	35RT	36	37-IMP	37-IM	37-SMP	37-SM	37-SIP
37-SI	38	39	39-IM	39plus	41	41CP	43	43F
44	45	49	50	52-MP	53BPR	54	55	56
63	SIM	ICC	IMM	PDIM	AFM	90488	90204	90402
90504	Glider Payload CTD		NiMH Battery Charger and Battery Pack					

Applicable EU Directives: Machinery Directive 98 / 37 /EC
 EMC Directive 2004 / 108 /EC
 Low Voltage Directive (73 / 23 /EEC) as amended by (93 / 68 /EEC)

Applicable Harmonized Standards:
 EN 61326-1:2006 Class A Electrical Equipment for Measurement, Control, and Laboratory Use, EMC Requirement – Part 1: General Requirements
 (EN 55011:2007 Group 1, Class A)
 EN 61010-1:2001, Safety Requirements for Electrical Equipments for Measurement, Control, and Laboratory Use – Part 1: General Requirements

Declaration based upon compliance to the Essential Requirements and Letter of Opinion from CKC Certification Services, LLC., Notified Body 0976

I, the undersigned, hereby declare that the equipment specified above conforms to the above European Union Directives and Standards.

Authorized Signature: 
 Name: Nordeen Larson
 Title of Signatory: President
 Date: 3 September 2013
 Place: Bellevue, WA

Table of Contents

Limited Liability Statement	2
Declaration of Conformity	3
Table of Contents	4
Section 1: Introduction	6
About this Manual	6
Quick Start	6
Unpacking FastCAT	7
Section 2: Description of FastCAT	8
System Description	8
Specifications.....	11
Dimensions and End Cap Connector	12
Cables and Wiring	13
Data I/O	14
Section 3: Power and Communications Test	15
Software Installation	15
Test Setup	15
Test	16
Section 4: Deploying and Operating FastCAT	20
Sampling Modes	20
Polled Sampling	21
Autonomous Sampling	22
Real-Time Data Corrections	24
Baud, Cable Length, and Data Transmission Rate.....	25
Power and Cable Length for FastCAT without Deck Unit	26
Command Descriptions.....	27
Data Output Formats.....	34
Optimizing Data Quality.....	36
Expelling Air from Plumbing for Optimal Pump Operation.....	36
Directing Exhaust away from Intake vs. Equalizing Bernoulli Pressures.....	37
Equalizing Pressures when Mounted on a Vehicle	38
Profiling Speed when Profiling from a Ship	38
Positioning Relative to Other Instruments and Package	38
Temperature Equilibration	38
Setup for Deployment	39
Deployment.....	40
Acquiring and Processing Data with Seasave and SBE Data Processing	41
Verifying Contents of Configuration (.xmlcon or .con) File	41
Acquiring Real-Time Data with Seasave.....	42
Processing Data with SBE Data Processing	43
Acquiring Real-Time Data with ROV, AUV, etc. for Processing by Sea-Bird Software	44
Recovery	45
Editing Raw Data File.....	46

Section 5: Routine Maintenance and Calibration	47
Corrosion Precautions.....	47
Connector Mating and Maintenance.....	47
Conductivity Cell Maintenance.....	48
Pressure Sensor Maintenance.....	48
O-Ring Maintenance.....	48
Handling Instructions for Plastic Housing.....	49
Replacing Optional Anti-Foulant Devices – Mechanical Design Change.....	50
Replacing Optional Anti-Foulant Devices (SBE 49).....	51
Sensor Calibration.....	53
Section 6: Troubleshooting	55
Problem 1: Unable to Communicate with FastCAT in Seaterm (terminal program).....	55
Problem 2: Seasave Data Acquisition is Cancelled – Timed Out.....	55
Problem 3: Unable to View Data in Seasave (Real-Time Data Acquisition program).....	55
Problem 4: Scan Length Error in SBE Data Processing.....	56
Problem 5: Unreasonable Data.....	56
Problem 6: Salinity Lower than Expected.....	56
Glossary	57
Appendix I: Functional Description and Circuitry	58
Sensors.....	58
Sensor Interface.....	58
Appendix II: Electronics Disassembly/Reassembly	59
Appendix III: Command Summary	60
Appendix IV: AF24173 Anti-Foulant Device	62
Appendix V: Real-Time Data Correction Algorithms	66
Aligning Data.....	66
Filtering Data.....	68
Applying Conductivity Cell Thermal Mass Correction to Data.....	68
Appendix VI: Replacement Parts	69
Appendix VI: Manual Revision History	72
Index	74

Section 1: Introduction

This section includes contact information, Quick Start procedure, and photos of a typical FastCAT shipment.

About this Manual

This manual is to be used with the SBE 49 FastCAT Profiler Conductivity, Temperature, and Pressure Sensor. It is organized to guide the user from installation through operation and data collection. We've included detailed specifications, command descriptions, maintenance and calibration information, and helpful notes throughout the manual.

Sea-Bird welcomes suggestions for new features and enhancements of our products and/or documentation. Please contact us with any comments or suggestions (seabird@seabird.com or 425-643-9866). Our business hours are Monday through Friday, 0800 to 1700 Pacific Standard Time (1600 to 0100 Universal Time) in winter and 0800 to 1700 Pacific Daylight Time (1500 to 0000 Universal Time) the rest of the year.

Quick Start

Follow these steps to get a Quick Start using the FastCAT. The manual provides step-by-step details for performing each task:

1. Test power and communications (*Section 3: Power and Communications Test*).
2. Deploy the FastCAT (*Section 4: Deploying and Operating FastCAT*):
 - A. Establish setup and sampling parameters.
 - B. Install I/O cable connector and locking sleeve. Connect other end of cable to computer/controller and to power supply.
 - C. Verify hardware and external fittings are secure.
 - D. Remove plugs from end of T-C Duct and pump exhaust.
 - E. Apply power.
 - If **AutoRun=Y**, FastCAT will start sampling automatically.
 - If **AutoRun=N**, send **Start** to start sampling.
 - F. Deploy FastCAT.

Unpacking FastCAT

Shown below is a typical FastCAT shipment.



SBE 49
FastCAT



I/O cable



Spare o-ring and hardware kit (includes tee exhaust for slow profiling applications)



Conductivity cell cleaning solution (Triton-X)



Conductivity cell filling and storage kit



Software, and Electronic Copies of Software Manuals and User Manual

Section 2: Description of FastCAT

This section describes the functions and features of the SBE 49 FastCAT, including specifications, dimensions, connector, and communications.

System Description

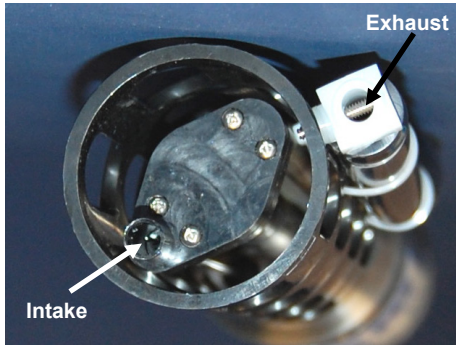

The SBE 49 FastCAT is an integrated CTD sensor intended for towed vehicle, ROV, AUV, or other autonomous profiling applications in marine or fresh-water environments at depths up to 350 meters (1150 feet) or 7000 meters (22,900 feet). The FastCAT's pump-controlled, TC-ducted flow minimizes salinity spiking, and its 16 Hz sampling provides very high spatial resolution of oceanographic structures and gradients.

The FastCAT's temperature thermistor and conductivity cell are the same as used in our premium 911*plus* CTD system. The strain-gauge pressure sensor is offered in eight full scale ranges from 20 to 7000 dbars. Sophisticated interface circuitry provides very high resolution and accuracy — entirely comparable to the 911*plus*.



The FastCAT is an easy-to-use, light, and compact instrument ruggedly made of titanium and other low-maintenance (plastic) materials; it is well suited to even the smallest vehicle. There are straightforward commands for continuous (full rate or averaged) or single sample acquisition. EEPROM-stored calibration coefficients permit data output in ASCII engineering units (degrees C, Siemens/m, decibars, Salinity [PSU], and sound velocity [m/sec]), or the user can select raw data output if desired.

The FastCAT is externally powered, and its data is telemetered by its RS-232C interface. The FastCAT has no memory or internal batteries, and does not support auxiliary sensor inputs.

The FastCAT samples in two modes:

- **Autonomous sampling** – The FastCAT runs continuously, sampling at sixteen scans per second (16 Hz). It can be set to average up to 255 samples, transmitting only the averaged data. Programmable real-time processing – aligning, filtering, and correcting data for conductivity cell thermal mass effects – provides high quality data for applications where post-processing is not feasible. The FastCAT can be programmed to begin autonomous sampling when power is applied or on command.
- **Polled sampling** – On command, the FastCAT takes one sample and transmits the data.

Note:

The FastCAT's pump is not designed to be used to pump water through other sensors. **Other sensors requiring pumped water need a separate pump.**

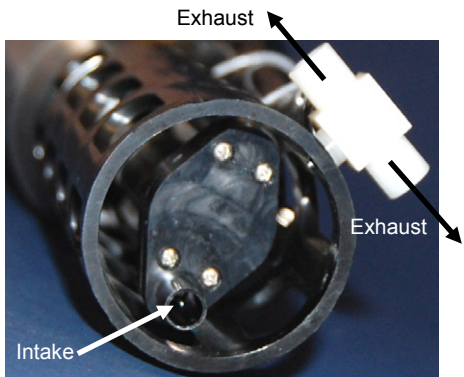

FastCAT with exhaust tee fitting

A FastCAT is supplied with:

- Plastic housing for depths to 350 meters (1150 feet) or titanium housing for depths to 7000 meters (22,900 feet)
- Strain-gauge pressure sensor
- Integrated T-C Duct
- Internal pump for flow-controlled conductivity and temperature response
- XSG or wet-pluggable MCBH 4-pin I/O bulkhead connector
- Straight pump exhaust fitting, providing high quality data for most applications
- Pump exhaust tee fitting, for slow profiling applications – tee fitting is included in spares kit that ships with FastCAT, and can be easily substituted for the straight pump exhaust fitting in the field. See **Optimizing Data Quality in Section 4: Deploying and Operating FastCAT for guidelines on use of the straight fitting vs. the tee fitting.**
- Optional anti-foulant device fitting and expendable Anti-Foulant Devices for long deployments

Notes:

- The SBE 32 Carousel is a 12-, 24-, or 36-bottle water sampler, available with bottle sizes up to 30 liters. The SBE 55 ECO is a 3- or 6-bottle water sampler with 4-liter bottles.
- Seasave also supports acquisition of data from a NMEA device connected directly to the computer (instead of the deck unit).
- SBE 33's NMEA interface was optional prior to 2010, and the Surface PAR interface was optional prior to 2012.

The FastCAT can be used with the following Sea-Bird equipment:

- **SBE 32 Carousel Water Sampler and SBE 33 Carousel Deck Unit OR SBE 55 ECO Water Sampler and SBE 33 Carousel Deck Unit** - The SBE 32 or SBE 55 provides +15 VDC power to the FastCAT. The CTD data from the FastCAT is converted into single-wire telemetry for transmission over long (10,000 meter [32,800 feet] sea cables). Bottles may be closed at any depth without interrupting CTD data via software control using the Seasave program or from the front panel of the SBE 33 Deck Unit. See the SBE 33 manual for system operating details.

SBE 55 Real-Time Operation

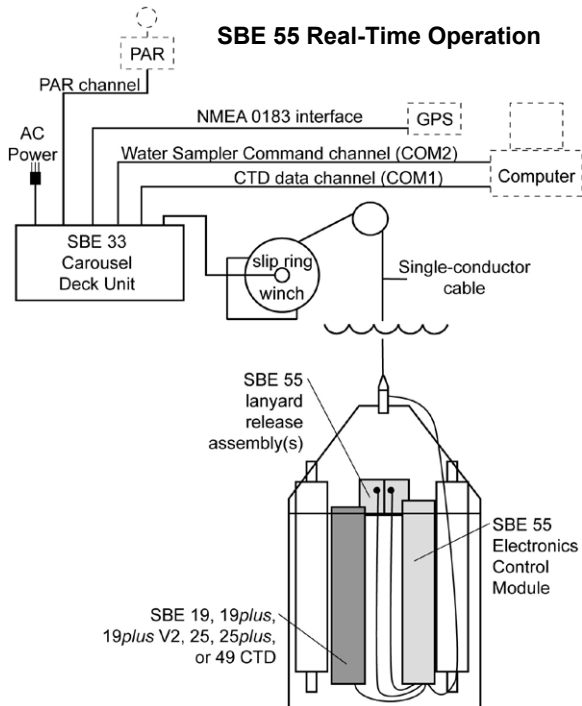

SBE 32 Real-Time Operation

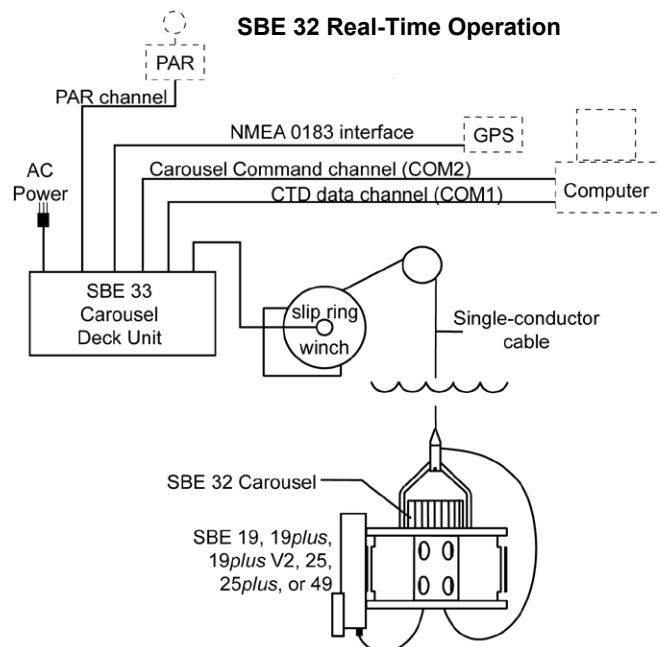

Note:

SBE 36's Surface PAR interface was optional prior to 2012.

SBE 36 CTD Deck Unit and Power Data Interface Module (PDIM) -

These items provide power and real-time data handling capability over single-conductor sea cables using the same method employed in the SBE 32 / SBE 33. The PDIM is a small pressure housing that is mounted on or near the FastCAT. It provides +15VDC power to the FastCAT and interfaces two-way RS-232 communications from the FastCAT to the telemetry used on the sea cable. See the SBE 36 / PDIM manual for system operating details.

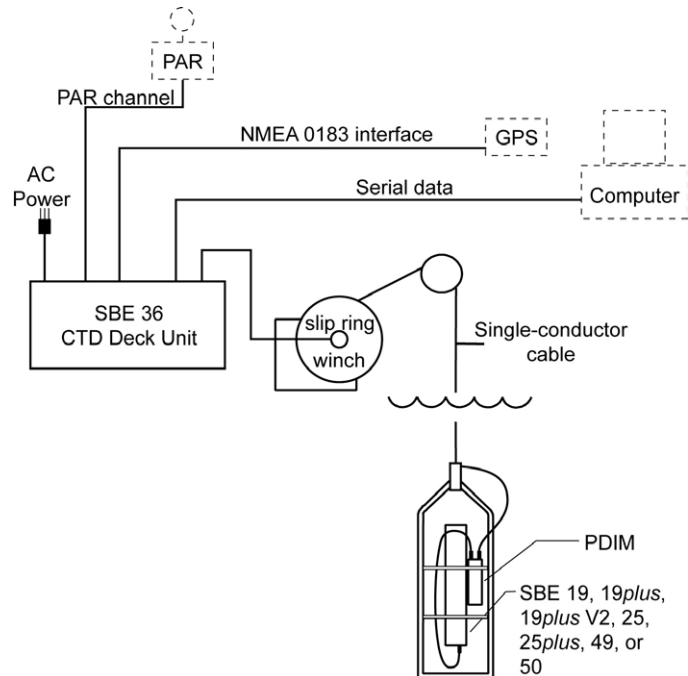
**Notes:**

- Help files provide detailed information on the software.
- Separate software manuals on CD provide detailed information on Seasave V7 and SBE Data Processing.
- Sea-Bird supplies the current version of our software when you purchase an instrument. As software revisions occur, we post the revised software on our FTP site. See our website (www.seabird.com) for the latest software version number, a description of the software changes, and instructions for downloading the software from the FTP site.

The FastCAT is supplied with a powerful Windows software package, Seasoft V2, which includes:

- **Seaterm** - terminal program for instrument setup and communication.
- **Seasave V7** - program for real-time acquisition and display of data. Seasave can be used for real-time data acquisition only if the FastCAT is directly connected to the computer (not connected to an AUV, ROV, etc.).
- **SBE Data Processing** - program for calculation and plotting of conductivity, temperature, pressure, and derived variables such as salinity and sound velocity.

Specifications

	Temperature (°C)	Conductivity (S/m)	Strain-Gauge Pressure
Measurement Range	-5 to +35	0 to 9	0 to full scale range: 20 / 100 / 350 / 600 / 1000 / 2000 / 3500 / 7000 meters (expressed in meters of deployment depth capability)
Initial Accuracy	± 0.002	±0.0003	± 0.1% of full scale range
Typical Stability	0.0002 per month	0.0003 per month	0.05% of full scale range per year
Resolution	0.0001	0.00005 (oceanic waters; resolves 0.4 ppm in salinity) 0.00007 (high salinity waters; resolves 0.4 ppm in salinity) 0.00001 (fresh waters; resolves 0.1 ppm in salinity)	0.002% of full scale range
Sensor Calibration (measurement outside these ranges may be at slightly reduced accuracy due to extrapolation errors)	+1 to +32	0 to 9; physical calibration over the range 2.6 to 6 S/m, plus zero conductivity (air)	Ambient pressure to full scale range in 5 steps
Power Requirements	0.75 Amps at 9-24 VDC Turn-on transient: 750 mA Sampling and transmitting data (includes pump): 390 mA at 9 V 285 mA at 12 V 180 mA at 19 V		
Housing Material & Depth Rating	Titanium (3AL/2.5V) - 7000 m (22,900 ft) Plastic - 350 m (1150 ft)		
Weight	<i>Titanium Housing</i> - <i>In air:</i> 2.7 kg (6 lbs) <i>In water:</i> 1.4 kg (3 lbs) <i>Plastic Housing</i> - <i>In air:</i> 1.8 kg (4 lbs) <i>In water:</i> 0.5 kg (1 lb)		

CAUTION:

See Section 5: Routine Maintenance and Calibration for handling instructions for the plastic housing.

Dimensions and End Cap Connector

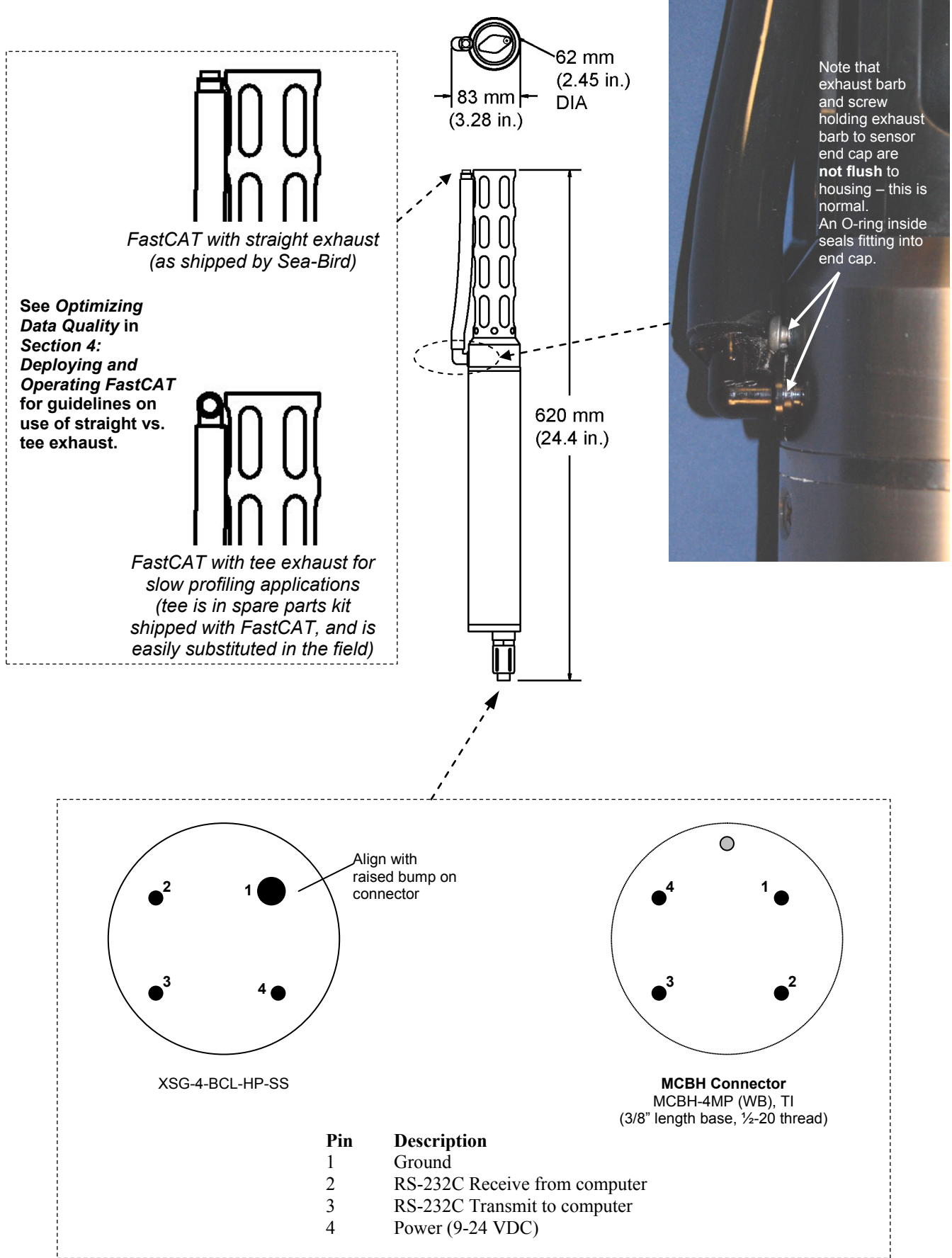

Cables and Wiring

RMG Connector Cable Wiring -- DN 32277

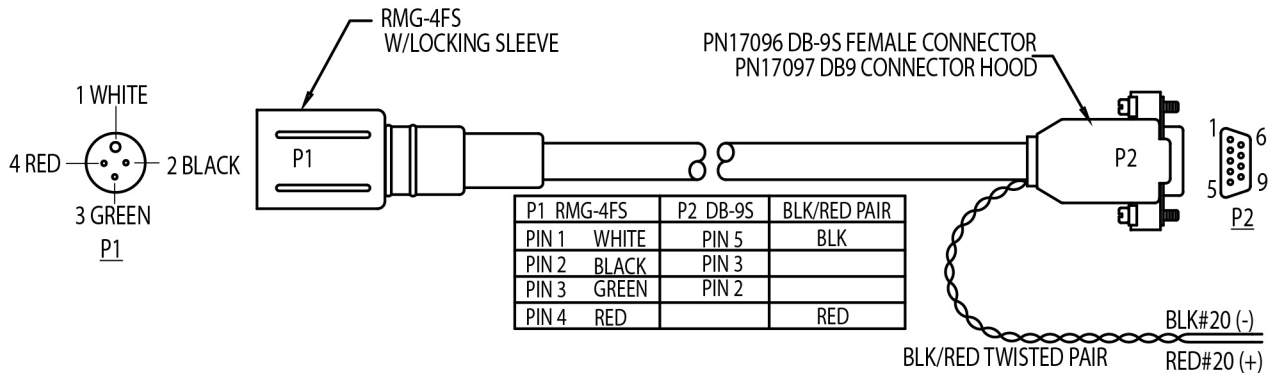

MCIL Wet-Pluggable Connector Cable Wiring -- DN 32366

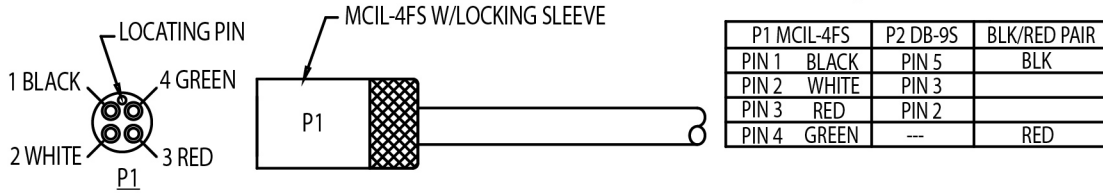

XSG Connector Wiring -- DN 32534

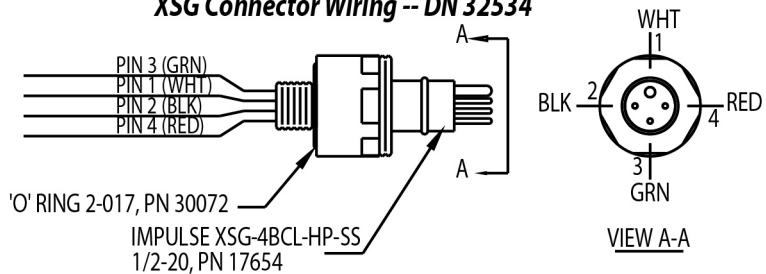

BULKHEAD CONNECTOR	PCB PADS	FUNCTION
PIN 1 (WHT)	GND	COMMON
PIN 2 (BLK)	RX	RX FROM PC
PIN 3 (GRN)	TX	TX TO PC
PIN 4 (RED)	PWR	EXTERNAL PWR

MCBH Wet-Pluggable Connector Wiring -- DN 32534

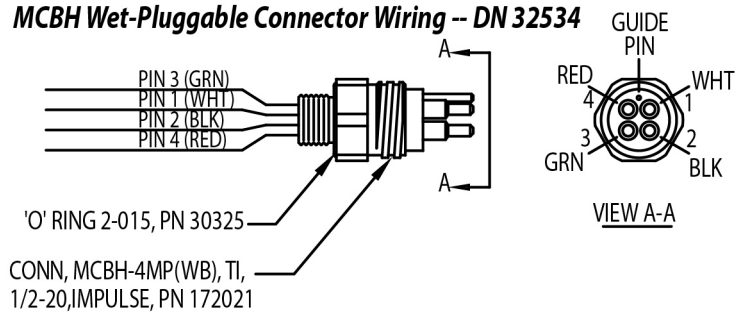

Data I/O

The FastCAT receives setup instructions and outputs data and diagnostic information via a three-wire RS-232C link, and is factory-configured for 9600 baud, 8 data bits, 1 stop bit, and no parity. FastCAT RS-232 levels are directly compatible with standard serial interface cards (IBM Asynchronous Communications Adapter or equal). The communications baud rate can be changed using the **Baud=** command (see *Section 4: Deploying and Operating FastCAT*).

Section 3:

Power and Communications Test

This section describes software installation and the pre-check procedure for preparing the FastCAT for deployment. The power and communications test will verify that the system works, prior to deployment.

Software Installation

Notes:

- Help files provide detailed information on the software. Separate software manuals on the CD provide details on Seasave V7 and SBE Data Processing.
- It is possible to use the FastCAT without Seaterm by sending direct commands from a dumb terminal or terminal emulator, such as Windows HyperTerminal.
- Sea-Bird supplies the current version of our software when you purchase an instrument. As software revisions occur, we post the revised software on our FTP site. See our website (www.seabird.com) for the latest software version number, a description of the software changes, and instructions for downloading the software from the FTP site.

Seasoft V2 was designed to work with a PC running Win XP Service pack 2 or later, Windows Vista, and Windows 7.

If not already installed, install Sea-Bird software programs on your computer using the supplied software CD:

1. Insert the CD in your CD drive.
2. Install software: Double click on **SeasoftV2.exe**. Follow the dialog box directions to install the software. The installation program allows you to install the desired components. Install all the components, or just install Seaterm (terminal program), Seasave V7 (real-time data acquisition), and SBE Data Processing (data processing).

The default location for the software is c:\Program Files\Sea-Bird. Within that folder is a sub-directory for each program.

Test Setup

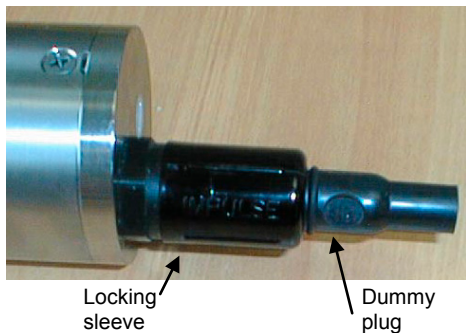

1. Remove the dummy plug and install the I/O cable:
 - A. By hand, unscrew the locking sleeve from the FastCAT's I/O connector. If you must use a wrench or pliers, be careful not to loosen the I/O connector instead of the locking sleeve.
 - B. Remove the dummy plug from the FastCAT's I/O connector by pulling the plug firmly away from the connector.
 - C. **XSG Connector** - Install the Sea-Bird I/O cable connector, aligning the raised bump on the side of the connector with the large pin (pin 1 - ground) on the FastCAT. **OR**
MCBH Connector – Install the cable connector, aligning the pins.
2. Connect the I/O cable connector to your computer's serial port.
3. Connect the I/O cable connector's red (+) and black (-) wires to a power supply (9-24 VDC). See *Section 2: Description of FastCAT*, for the connector details.

Test

Note:

See Seaterm's help files for detailed information.

1. Double click on SeaTerm.exe. If this is the first time the program is used, the setup dialog box may appear:



Select the instrument type (*SBE 49*) and the computer COM port for communication with the FastCAT. Click OK.

2. The main screen looks like this:

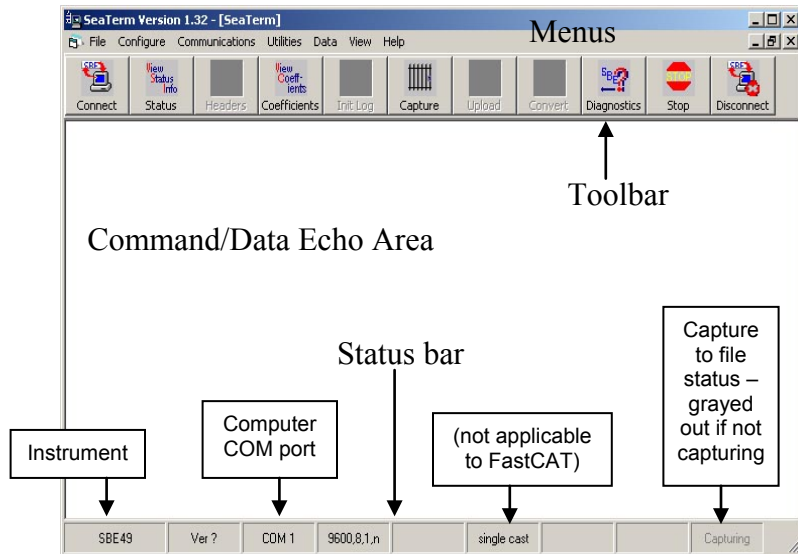

Note:

There is at least one way, and as many as three ways, to enter a command:

- Manually type a command in Command/Data Echo Area
- Use a menu to automatically generate a command
- Use a Toolbar button to automatically generate a command

Note:

Once the system is configured and connected (Steps 3 through 5 below), to update the Status bar:

- on the Toolbar, click Status; or
- from the Utilities menu, select Instrument Status.

Seaterm sends the status command, which displays in the Command/Data Echo Area, and updates the Status bar.

- Menu – Contains tasks and frequently executed instrument commands.
- Toolbar – Contains buttons for frequently executed tasks and instrument commands. All tasks and commands accessed through the Toolbar are also available in the Menu. To display or hide the Toolbar, select View Toolbar in the View menu. Grayed out Toolbar buttons are not applicable.
- Command/Data Echo Area – Echoes a command executed using a Menu or Toolbar button, as well as the instrument's response. Additionally, a command can be manually typed in this area, from the available commands for the instrument. Note that the instrument must be *awake* for it to respond to a command (use Connect on the Toolbar to wake up the instrument).
- Status bar – Provides status information. To display or hide the Status bar, select View Status bar in the View menu.

Following are the Toolbar buttons applicable to the FastCAT:

Toolbar Button	Description	Equivalent Command*
Connect	Re-establish communications with FastCAT. Computer responds with S> prompt.	(press Enter key)
Status	Display instrument setup and status (configuration and setup parameters, whether FastCAT is sampling, etc.).	DS
Coefficients	Display calibration coefficients.	DCal
Capture	Capture instrument responses on screen to file; useful for diagnostics. File has .cap extension. Capture status displays in Status bar. Press Capture again to turn off capture. As FastCAT has no internal memory, if you are using Seaterm to acquire data you must capture before sampling begins to save data for future review and processing. (Note: The .cap file does not have the required header information for processing by SBE Data Processing. Use Seasave to acquire data that will be processed by SBE Data Processing.)	—
Diagnostics	Perform one or more diagnostic tests on FastCAT. Diagnostic test(s) accessed in this manner are non-destructive – they do not write over any existing instrument settings.	DS, DCal, and TS
Stop	Interrupt and end current activity, such as sampling or diagnostic test.	(press Esc key or Ctrl C)
Disconnect	Free computer COM port used to communicate with FastCAT. COM port can then be used by another program.	—

*See *Command Descriptions* in *Section 4: Deploying and Operating FastCAT*.

- In the Configure menu, select *SBE 49*. The dialog box looks like this:

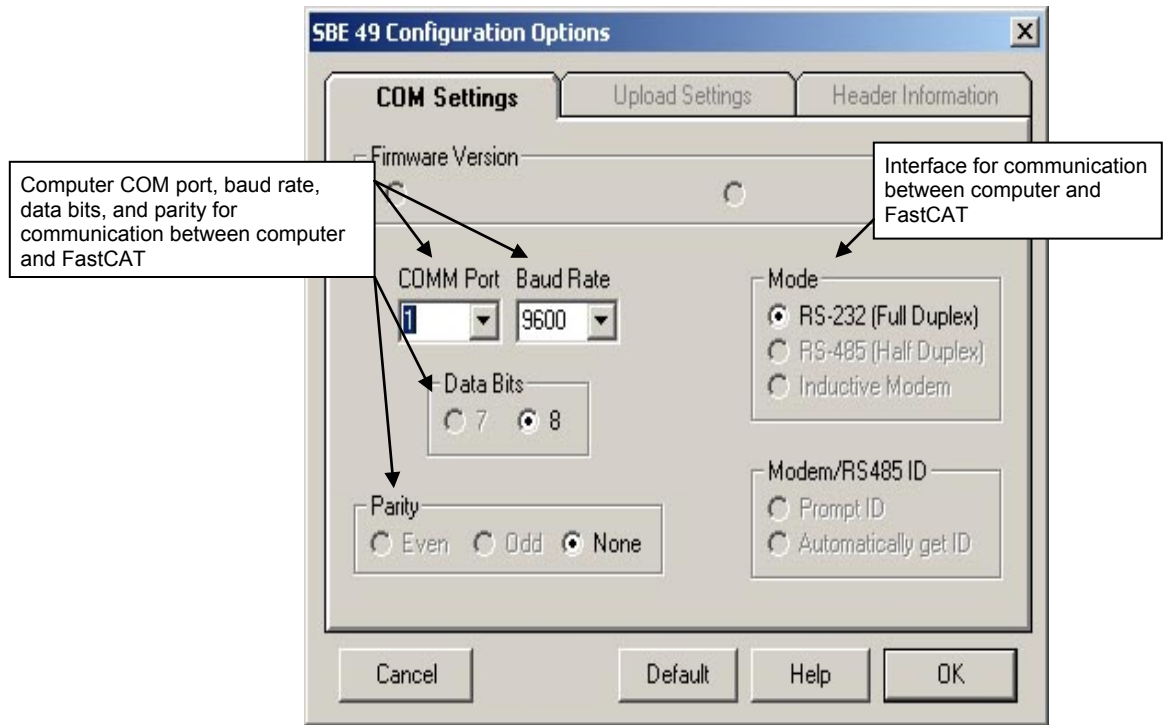

Note:

- Seaterm's baud rate must be the same as the FastCAT baud (set with **Baud=**). Baud is factory-set to 9600, but can be changed by the user (see *Command Descriptions* in *Section 4: Deploying and Operating FastCAT*).
- When you click OK, Seaterm saves the Configuration Options settings to the SeaTerm.ini file in your Windows directory. SeaTerm.ini contains the last saved settings for **each** instrument. When you open Seaterm and select the desired instrument (SBE 37, 49, etc.) in the Configure menu, the Configuration Options dialog box shows the last saved settings for that instrument.

Make the selections in the Configuration Options dialog box:

- COMM Port:** COM 1 through COM 10, as applicable
- Baud Rate:** 9600 (documented on Configuration Sheet in manual)
- Data Bits:** 8
- Parity:** None
- Mode:** RS-232 (Full Duplex)

Click OK to save the settings.

- In the Communications menu, select *Options / Cycle baud when connecting*.
- Click Connect on the Toolbar. Seaterm tries to connect to the FastCAT at the baud set in Step 3. If it cannot, it cycles through all other possible baud rates to try to connect. When it connects, the display looks like this:

S>

This shows that correct communications between the computer and the FastCAT has been established.

If the system does not respond with the S> prompt:

- Click Connect again.
- Verify the correct instrument was selected in the Configure menu and the settings were entered correctly in the Configuration Options dialog box. Note that the baud rate is documented on the Configuration Sheet in the manual.
- Check cabling between the computer and FastCAT.

6. Display FastCAT status information by clicking Status on the Toolbar. The display looks like this:

```
SBE 49 FastCAT V 1.3a SERIAL NO. 0055
number of scans to average = 1
pressure sensor = strain gauge, range = 1000.0
minimum cond freq = 3000, pump delay = 30 sec
start sampling on power up = no
output format = converted decimal
output salinity = no, output sound velocity = no
temperature advance = 0.0625 seconds
celltm alpha = 0.03
celltm tau = 7.0
real-time temperature and conductivity correction enabled for converted data
```

7. Command the FastCAT to take a sample by typing **TS** and pressing the Enter key. The display looks like this (with converted decimal output format, and no output salinity or sound velocity):

```
23.7658, 0.00019, 0.062
```

where 23.7658 = temperature in degrees Celsius
 0.00019 = conductivity in S/m
 0.062 = pressure in decibars

These numbers should be reasonable; i.e., room temperature, zero conductivity, barometric pressure (gauge pressure).

The FastCAT is ready for programming and deployment.

Section 4: Deploying and Operating FastCAT

Note:

Help files contain detailed information on software setup and use.

This section includes discussions of:

- Sampling modes, including pump operation and example commands
- Real-time data corrections
- Baud rate, cable length, and data transmission rate
- Power and cable length
- Command descriptions
- Data output formats
- Optimizing data quality –orientation, mounting, speed, use of straight vs tee exhaust fitting
- Setup for deployment
- Deployment
- Acquiring and processing FastCAT data
- Recovery - physical handling

Sampling Modes

The FastCAT has two sampling modes for obtaining data:

- Polled sampling
- Autonomous sampling

Descriptions and examples of the sampling modes follow. Note that the FastCAT's response to each command is not shown in the examples. Review the operation of the sampling modes and the commands described in *Command Descriptions* before setting up your system.

Polled Sampling

On command (**TS**), the FastCAT takes one sample and transmits the data real-time.

The pump does not turn on automatically for polled sampling (**MinCondFreq=** and **PumpDelay=** do not apply). To run the pump before taking a sample, send **PumpOn** to turn the pump on before sending **TS**. Send **PumpOff** to turn the pump off after taking the sample.

Example: Polled Sampling (user input in bold)

Apply power and wake up FastCAT. Set up to not start automatic autonomous sampling when power is applied, to output data in decimal engineering units format, and to output salinity and sound velocity as well as conductivity, temperature, and pressure. Verify setup with status command. Remove power.

(Apply power, then click Connect on Toolbar to wake up.)

S>**AUTORUN=N**

S>**OUTPUTFORMAT=3**

S>**OUTPUTSAL=Y**

S>**OUTPUTSV=Y**

S>**DS** (to verify setup)

(Remove power.)

When ready to take a sample, put FastCAT in water. Apply power and wake up FastCAT. Command FastCAT to turn pump on, take a sample, and turn pump off. Remove power. Repeat as desired.

(Apply power, then click Connect on Toolbar to wake up.)

S>**PUMPON**

S>**TS**

S>**PUMPOFF**

(Remove power.)

Autonomous Sampling

The FastCAT runs continuously, sampling data at 16 scans per second (16 Hz) and transmitting the data real-time. The FastCAT can be set to average up to 255 samples, transmitting only the averaged data. **AutoRun** defines how autonomous sampling starts and stops:

If	To Start Sampling	To Stop Sampling
AutoRun=Y	Turn on power.	<ul style="list-style-type: none"> • Turn off power, or • Send Stop, click Stop on Seaterm's Toolbar, or type Ctrl Z. (Stopping this way allows you to then send commands to check or modify the setup.)
AutoRun=N	Send Start .	

After the conductivity cell enters the water there is a user-programmable delay before pump turn-on so that all the air in the pump tubing can escape. If the pump motor turns on when there is air in the impeller housing, priming is uncertain and a proper flow rate cannot be ensured. **The cell inlet and pump outlet must not come above the water surface or the prime will be lost.**

- If prime is lost, stop sampling. Wait at least 5 seconds, then submerge the FastCAT completely, restart sampling, and wait for the pump delay time before beginning the profile.

Pump turn-on occurs when two user-programmable conditions have been met:

- **Raw conductivity frequency exceeds the minimum conductivity frequency (MinCondFreq=)**

Set the minimum conductivity frequency for pump turn-on above the instrument's *zero conductivity raw frequency* (shown on the FastCAT Configuration Sheet in the manual), to prevent the pump from turning on when the FastCAT is in air.

- For salt water and estuarine applications -
typical value = *zero conductivity raw frequency* + 500 Hz
- For fresh/nearly fresh water -
typical value = *zero conductivity raw frequency* + 5 Hz

If the minimum conductivity frequency is too close to the *zero conductivity raw frequency*, the pump may turn on when the FastCAT is in air as result of small drifts in the electronics. Some experimentation may be required, and in some cases it may be necessary to rely only on the pump turn-on delay time to control the pump. If so, set a minimum conductivity frequency lower than the *zero conductivity raw frequency*.

- **Pump turn-on delay time has elapsed (PumpDelay=)**

Set the pump turn-on delay time to allow time for the pump to fill with water after the FastCAT is submerged. Determine the turn-on delay by immersing the FastCAT (power off, not sampling). Measure the time needed to completely fill the pump exhaust tubing (by watching for when air bubbles stop coming out of the exhaust); 20 seconds is typical. Set the delay to approximately 1.5 times longer (30 seconds). When actually using the FastCAT, be sure to *soak* the instrument just under the surface for at least the time required for pump turn-on.

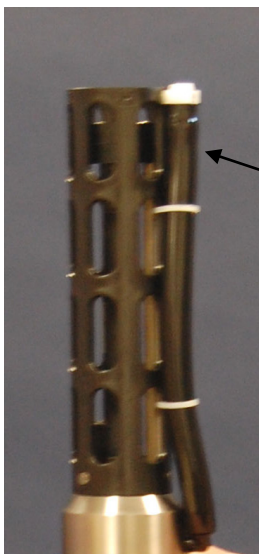

Pump exhaust tubing

Pump turn-off occurs when the conductivity frequency falls below the minimum conductivity frequency (**MinCondFreq=**).

Note:

Sea-Bird ships the FastCAT with **AutoRun=N** (it will not start sampling when power is applied). If you send **AutoRun=Y**, turn power off and then on again to start sampling, or send **Start**.

*Example 1: Autonomous Sampling Setup for **AutoRun=N** (user input in bold)*

Apply power and wake up FastCAT. Set up to average every 4 samples, and output data in raw hexadecimal format. Set up with a 60-second pump turn-on delay after pump enters water to ensure pump is primed before turning on. Verify setup with status command. Remove power.

(Apply power, then click Connect on Toolbar to wake up.)

S>**NAVG=4**

S>**OUTPUTFORMAT=0**

S>**PUMPDELAY=60**

S>**AUTORUN=N**

S>**DS** (to verify setup)

(Remove power.)

When ready to begin sampling:

(Apply power, then click Connect on Toolbar to wake up.)

S>**START**

(Put FastCAT in water, and allow to soak for at least time required for pump turn-on (**PUMPDELAY=60**) before beginning cast.)

When cast is complete, stop sampling.

S>**STOP**

*Example 2: Autonomous Sampling Setup for **AutoRun=Y** (user input in bold)*

Apply power. Set up to average every 4 samples, and output data in raw hexadecimal format. Set up with a 60-second pump turn-on delay after pump enters water to ensure pump is primed before turning on. Set up to start sampling upon power up. Verify setup with status command.

(Apply power, then click Connect on Toolbar to wake up.)

S>**NAVG=4**

S>**OUTPUTFORMAT=0**

S>**PUMPDELAY=60**

S>**AUTORUN=Y**

S>**DS** (to verify setup)

(Remove power.)

When ready to begin sampling:

(Apply power.)

(Put FastCAT in water, and allow to soak for at least time required for pump turn-on (**PumpDelay=60**) before beginning cast.)

When cast is complete, remove power or send **Stop** to stop sampling (send **Stop** if you want to view and/or modify FastCAT's setup immediately after you stop sampling).

Real-Time Data Corrections

Note:

Cell thermal mass corrections should not be applied to freshwater data. It can give bad results, due to the way the derivative dc/dT is calculated in regions where conductivity changes are very small. Currently, the SBE 49 firmware does not permit you to apply just aligning and filtering, without also applying cell thermal mass corrections.

Typical *post-processing* of CTD data includes the following:

- **Aligning data** – Data misalignment is caused by physical misalignment of sensors in depth, inherent time delay of sensor responses, and water transit time in a plumbing line. Aligning conductivity, temperature, and pressure (C, T, and P) ensures that derived parameters are calculated with measurements from the same parcel of water, eliminating *spiking* caused by misaligned values in areas with sharp gradients.
- **Filtering data** – Filtering matches the T and C sensor time constants.
- **Correcting for conductivity cell thermal mass** – The glass cell stores heat, causing water in the cell to be a different temperature than the temperature sensor measured a moment earlier. Removing thermal mass effects from measured conductivity provides improved results in areas with steep temperature gradients.

Performing these calculations in post-processing allows you to make adjustments to the measured data before calculating derived parameters. SBE Data Processing, part of our Seasoft suite, can perform this processing on recorded data, if a complete C, T, and P time series is recorded. However, the FastCAT, which samples and transmits data at 16 Hz, is frequently integrated with an AUV or ROV. The AUV/ROV may record data on command, with uneven time intervals between each recorded measurement. The lack of a true time series from the FastCAT for these applications prevents aligning, filtering, and correcting for cell thermal mass in post-processing.

Therefore, the FastCAT can be programmed to process data in real-time if sampling autonomously. This provides C, T, and P output that is already aligned, filtered, and corrected for cell thermal mass, and also provides calculated and output salinity and sound velocity (if applicable) based on these corrected values.

Notes:

- The FastCAT does not perform real-time corrections if the output format is raw hex or raw decimal (**OutputFormat=0** or **2**), even if **ProcessRealTime=Y**.
- See *Appendix V: Real-Time Data Correction Algorithms* for details.

If real-time corrections are enabled (**ProcessRealTime=Y**) and the output format is converted hex or decimal (**OutputFormat=1** or **3**), the FastCAT processes the data as follows:

1. Advance temperature by user-programmed amount (**TAdvance=**).
2. Filter temperature and conductivity with cosine filter and five-scan window.
3. Apply cell thermal mass correction to conductivity, with user-programmed values for alpha (**Alpha=**) and tau (**Tau=**).
4. Calculate averaged data (if **NAvg=** is greater than 1) based on corrected values of C, T, and P.
5. Calculate salinity (if **OutputSal=Y**) and sound velocity (if **OutputSV=Y**) based on corrected, averaged values of C, T, and P.

Example: Autonomous Sampling Setup for Real-Time Data Processing (user input in bold)

See either of the autonomous sampling examples above for general setup. Send the following commands to enable and establish parameters for real-time data processing: output converted decimal data, enable real-time data corrections, advance temperature 0.0625 seconds, and use alpha and tau of 0.03 and 7 respectively, for cell thermal mass correction.

```
S>OUTPUTFORMAT=3
S>PROCESSREALTIME=Y
S>TADVANCE=0.0625
S>ALPHA=0.03
S>TAU=7
```

Baud, Cable Length, and Data Transmission Rate

Without a Sea-Bird Deck Unit

Notes:

- Baud rate is set with **Baud=**.
- Real-time output rate is set with **NAvg=**.
- Output format is set with **OutputFormat=**.
See *Command Descriptions*.

The rate that real-time data can be transmitted from the FastCAT is dependent on the amount of data to be transmitted per scan and the serial data baud rate:

$$\text{Time required to transmit data} = \frac{\text{(number of characters * 10 bits/character)}}{\text{baud rate}}$$

where

Number of characters is dependent on included data and output format (see *Data Output Formats*). Add 2 to the number of characters shown in the output format, to account for the carriage return and line feed at the end of each scan. For decimal output (**OutputFormat=2 or 3**), include decimal points, commas, and spaces when counting characters.

Time required to transmit data must be less than the real-time output rate. Minimum baud rates are tabulated below for 16 Hz sampling (**NAvg=1**) and 8 Hz sampling (**NAvg=2**): (see *Examples* below for calculation examples)

NAvg	OutputFormat	Minimum Baud
1	0 or 1	4800
	2 or 3*	9600
2	0 or 1	2400
	2 or 3*	4800

* Including output of salinity and sound velocity.

The length of cable that the FastCAT can drive to transmit real-time data is also dependent on the baud rate. The allowable combinations are:

Maximum Cable Length (m)	1600	800	400	200	100	50	25
Maximum Baud	600	1200	2400	4800	9600	19200	38400

Example 1 - What is fastest rate you can transmit real-time data over 800 m with **OutputFormat=0** (raw hex data)?

With 800 meters of cable, the FastCAT requires a baud rate of 1200 or less.

Number of characters for **OutputFormat=0** (from *Data Output Formats*) =

$$6 (T) + 6 (C) + 6 (P) + 4 (P \text{ temperature compensation}) + 2 (\text{carriage return \& line feed}) = 24$$

Time required to transmit data = $(24 \text{ characters} * 10 \text{ bits/character}) / 1200 = 0.2 \text{ sec} > 0.0625 \text{ sec}$ (16 Hz, maximum sampling rate).

Therefore, set **NAvg=4**, averaging 4 measurements/sample and transmitting 1 sample every 0.25 seconds.

Example 2 – Same as above, but **OutputFormat=3** (engineering units in decimal), and **OutputSV=Y** and **OutputSal=Y** (calculated salinity and sound velocity along with pressure, temperature, and conductivity).

Number of characters for **OutputFormat=3** (from *Data Output Formats*) =

$$8 (T) + 2 (\text{comma \& space}) + 8 (C) + 2 (\text{comma \& space}) + 8 (P) + 2 (\text{comma \& space}) +$$

$$8 (\text{salinity}) + 2 (\text{comma \& space}) + 8 (\text{sound velocity}) + 2 (\text{carriage return \& line feed}) = 50$$

Time required to transmit data = $(50 \text{ characters} * 10 \text{ bits/character}) / 1200 = 0.42 \text{ sec} > 0.0625 \text{ sec}$ (16 Hz, maximum sampling rate).

Therefore, set **NAvg=7**, averaging 7 measurements/sample and transmitting 1 sample every 0.4375 seconds.

With a Sea-Bird Deck Unit

Set the FastCAT baud rate to 4800 if using the FastCAT with either of the following real-time data acquisition systems:

- SBE 36 CTD Deck Unit and PDIM
- SBE 33 Carousel Deck Unit and SBE 32 Carousel Water Sampler **OR**
SBE 33 Carousel Deck Unit and SBE 55 ECO Water Sampler

The data telemetry link can drive 10,000 meters of cable while accepting 4800 baud serial data. The relationship between transmission rate, amount of data transmitted, and baud rate is as described above for a FastCAT without a Deck Unit.

Example – FastCAT with SBE 36 and PDIM. What is fastest rate you can transmit data over 800 m with **OutputFormat=0** (raw hex data, which is the required output format for use with the Deck Unit)?

With a Deck Unit, the FastCAT requires a baud rate of 4800.

Number of characters for **OutputFormat=0** (from *Data Output Formats*) =

$$6 (T) + 6 (C) + 6 (P) + 4 (P \text{ temperature compensation}) + 2 (\text{carriage return \& line feed}) = 24$$

Time required to transmit data = $(24 \text{ characters} * 10 \text{ bits/character}) / 4800 = 0.05 \text{ sec} < 0.0625 \text{ sec}$ (16 Hz, maximum sampling rate).

Therefore, set **NAvg=1**, providing 16 Hz data (1 sample every 0.0625 seconds).

Power and Cable Length for FastCAT without Deck Unit

On the ship, cables longer than 3 meters should be installed inside an earthed metal conduit by a qualified electrician. This minimizes the potential for external signals to disrupt communication and ensures that high voltage lines (such as the sea cable) are sufficiently protected. Cables shorter than 3 meters can be used without shielding when installing or bench testing the instrument.

Note:

Common wire resistances:

Gauge	Resistance (ohms/foot)
12	0.0016
14	0.0025
16	0.0040
18	0.0064
19	0.0081
20	0.0107
22	0.0162
24	0.0257
26	0.0410
28	0.0653

There are two issues to consider:

- Limiting the communication IR loss to 1 volt **if transmitting real-time data**; higher IR loss will cause the instrument to transmit data that does not meet the RS-232 communication standard.
- Supplying enough power at the power source so that sufficient power is available at the instrument after considering IR loss from the turn-on transient.

Each issue is discussed below.

Limiting IR Loss to 1 Volt

The limit to cable length is typically reached when the maximum current during **communication** times the power common wire resistance is more than 1 volt.

$$V_{\text{limit}} = 1 \text{ volt} = IR_{\text{limit}}$$

$$\text{Maximum cable length} = R_{\text{limit}} / \text{wire resistance per foot}$$

where I = current required by FastCAT during communication.

The value for I varies, depending on the input voltage –

- 390 mA at 9 V
- 285 mA at 12 V
- 180 mA at 19 V

See *Specifications* in *Section 2: Description of FastCAT*.

Example – For 12 volt power supply and 20 gauge wire, what is the maximum distance to transmit power to the FastCAT when considering communication IR loss?

At 12 V, I = 0.285 Amps. For 20 gauge wire, resistance is 0.0107 ohms/foot.

$$R_{\text{limit}} = V_{\text{limit}} / I = 1 \text{ volt} / 0.285 \text{ Amps} = 3.5 \text{ ohms}$$

Therefore, maximum cable length is 3.5 ohms / 0.0107 ohms/foot = 327 feet = 100 meters.

Note that 100 meters < 800 meters (limit to distance FastCAT can transmit data at 1200 baud, as shown in example in *Baud, Cable Length, and Data Transmission Rate*), so cable is limited to 100 meters because of power constraints.

Alternatively, you can transmit data over 800 meters but provide a power source closer to the FastCAT.

Supplying Enough Power to FastCAT

Another consideration in determining maximum cable length is supplying enough power at the power source so that sufficient voltage is available, after IR loss in the cable (**from the 0.75 Amp turn-on transient, two-way resistance**), to power the FastCAT. Provide at least 9 volts, after IR loss.

$$V - IR \geq 9 \text{ volts}$$

where I = FastCAT turn-on transient (0.75 Amps; see *Specifications* in *Section 2: Description of FastCAT*).

Example 1 – For 20 gauge wire, what is maximum distance to transmit power to FastCAT if using 12 volt power source?

$$V - IR \geq 9 \text{ volts} \quad 12 \text{ volts} - (0.75 \text{ Amps}) * (0.0107 \text{ ohms/foot} * 2 * \text{cable length}) \geq 9 \text{ volts}$$

$$3 \text{ volts} \geq (0.75 \text{ Amps}) * (0.0107 \text{ ohms/foot} * 2 * \text{cable length}) \quad \text{Cable length} \leq 187 \text{ ft} = 57 \text{ meters}$$

Note that 57 meters < 100 meters (maximum distance when considering communication IR loss), so supplying enough power during power-on transient is controlling factor for this example. Using a different wire gauge would increase allowable cable length.

Example 2 – Same as above, but there are 4 FastCATs powered from same power supply.

$$V - IR \geq 9 \text{ volts} \quad 12 \text{ volts} - (0.75 \text{ Amps} * 4 \text{ FastCATs}) * (0.0107 \text{ ohms/foot} * 2 * \text{cable length}) \geq 9 \text{ volts}$$

$$3 \text{ volts} \geq (0.75 \text{ Amps} * 4 \text{ FastCATs}) * (0.0107 \text{ ohms/foot} * 2 * \text{cable length})$$

$$\text{Cable length} \leq 46 \text{ ft} = 14 \text{ meters (to FastCAT furthest from power source)}$$

Command Descriptions

This section describes commands and provides sample outputs.
See *Appendix III: Command Summary* for a summarized command list.

When entering commands:

- Input commands to the FastCAT in upper or lower case letters and register commands by pressing the Enter key.
- The FastCAT sends `?CMD` if an invalid command is entered.
- If the system does not return an `S>` prompt after executing a command, press the Enter key to get the `S>` prompt.
- Establish communications by pressing Connect on the Toolbar or the Enter key to get an `S>` prompt.
- If the FastCAT is transmitting data and you want to stop it, send **Stop**, click Stop on the Toolbar, or type Ctrl Z. Press the Enter key to get the `S>` prompt.
- The FastCAT responds only to **DS**, **DCal**, and **Stop** while sampling. If you interrupt the FastCAT while it is sampling (for example, to send **DS**), it will temporarily stop sampling. Sampling resumes after it responds to the command.

Entries made with the commands are permanently stored in the FastCAT and remain in effect until you change them.

Status Command

DS

Display operating status and setup parameters.
Equivalent to Status on Toolbar.

List below includes, where applicable, command used to modify parameter.

- firmware version, serial number
- number of scans to average [**NAvg=**]
- pressure sensor type and range [**PRange=**]
- minimum conductivity frequency for pump turn-on [**MinCondFreq=**] and pump turn-on delay [**PumpDelay=**]
- start autonomous sampling automatically when power applied [**AutoRun=**]?
- output format [**OutputFormat=**]
- output salinity [**OutputSal=**] and sound velocity [**OutputSV=**] with each sample? (only if **OutputFormat=3**)
- time to advance temperature to align with conductivity [**TAdvance=**]
- conductivity cell thermal mass alpha correction [**Alpha=**]
- conductivity cell thermal mass tau correction [**Tau=**]
- enable real-time corrections [**ProcessRealTime=**]?

Note:

If **ProcessRealTime=Y** but **OutputFormat=0** or **2** (output raw hexadecimal or raw decimal data), the status reply shows:
real-time temperature and conductivity correction enabled, not applied to raw data,
and the FastCAT does not perform real-time corrections.

Example: Status (DS) command (user input in bold; command used to modify parameter in parentheses)

```

S>DS
SBE 49 FastCAT V 1.3a SERIAL NO. 0055
number of scans to average = 1
pressure sensor = strain gauge, range = 1000.0
minimum cond freq = 3000, pump delay = 30 sec
start sampling on power up = no
output format = converted decimal
output salinity = yes, output sound velocity = yes
temperature advance = 0.0625 seconds
celltm alpha = 0.03
celltm tau = 7.0
real-time temperature and conductivity correction enabled for converted data

```

[NAvg=]
[PRange=]
[MinCondFreq=, PumpDelay=]
[AutoRun=]
[OutputFormat=]
[OutputSal=, OutputSV=]
[TAdvance=]
[Alpha=]
[Tau=]
[ProcessRealTime=]

Setup Commands

Notes:

- The FastCAT's baud rate (set with **Baud=**) must be the same as Seaterm's baud rate (set in the Configure menu).
- The minimum baud is dependent on sampling rate (**NAvg=**) and output format (**OutputFormat=**). See *Baud, Cable Length, and Data Transmission Rate* and *Data Output Formats*.

Note:

Sea-Bird's real-time data acquisition software (Seasave) requires data in raw hexadecimal (**OutputFormat=0**).

Before beginning a cast:

- If you will be using **Seasave** to view and save real-time data for future processing by SBE Data Processing - **You must set output format to raw hex.**
- If you will be using **Seaterm** to view and capture real-time data (cannot be processed by SBE Data Processing) - Set output format to converted decimal for ease in viewing data.

The FastCAT does not perform real-time corrections if the output format is raw hex or raw decimal (**OutputFormat=0** or **2**), even if **ProcessRealTime=Y**.

Baud=x

x= baud rate (1200, 2400, 4800, 9600, 19200, or 38400). Default 9600.

OutputFormat=x

x= 0: Output raw frequencies, A/D counts, and voltages in Hexadecimal form. **Must use this format for acquiring, viewing, and saving real-time data in Seasave. Seasave creates a data file that can be processed with SBE Data Processing** (see *Acquiring and Processing Real-Time Data with Seasave and SBE Data Processing*).

x= 1: Output converted (engineering units) data in Hexadecimal form.

x= 2: Output raw data in decimal form.

x= 3: Output converted (engineering units) data in decimal form. Must use this format to output salinity or sound velocity. If logging data to ROV, AUV, etc., use this format if you want to process saved data with SBE Data Processing (see *Acquiring Real-Time Data with ROV, AUV, etc. for Processing by Sea-Bird Software*). Default.

OutputSal=x

x= Y: Calculate and output salinity (psu). Only applies if **OutputFormat=3**. Default.

x= N: Do not calculate and output salinity.

OutputSV=x

x= Y: Calculate and output sound velocity (m/sec), using Chen and Millero formula (UNESCO Technical Papers in Marine Science #44). Only applies if **OutputFormat=3**. Default.

x= N: Do not calculate and output sound velocity.

SetDefaults**Note:**

See *Autonomous Sampling Commands* below for **NAvg=**, **MinCondFreq=**, **PumpDelay=**, **ProcessRealTime=**, **TAdvance=**, **Alpha=**, **Tau=**, and **AutoRun=** descriptions; these commands apply only to autonomous sampling.

Reset following to default values:

- **OutputFormat=3**
- **OutputSal=Y**
- **OutputSV=Y**
- **NAvg=1**
- **MinCondFreq=3000**
- **PumpDelay=30**
- **ProcessRealTime=Y**
- **TAdvance=0.0625**
- **Alpha=0.03**
- **Tau=7.0**
- **AutoRun=N**

Note:
 In Seaterm, to save real-time data to a file, click Capture on the Toolbar before beginning sampling.

Autonomous Sampling Commands

Autonomous sampling directs the FastCAT to sample data at 16 Hz and transmit the data real-time. The FastCAT can be set to average up to 255 samples, transmitting only the averaged data. **AutoRun** defines how autonomous sampling starts and stops:

IF	To Start Sampling	To Stop Sampling
AutoRun=N (default)	Send Start .	<ul style="list-style-type: none"> • Turn off power, or • Send Stop, click Stop on Seaterm’s Toolbar, or type Ctrl Z. (Stopping this way allows you to then send commands to check or modify the setup.)
AutoRun=Y	Turn on power.	

NAvg=x

x= number of samples to average (default 1, maximum 255). FastCAT samples at 16 Hz (every 0.0625 seconds) and averages **NAvg** samples; averaged data is transmitted real-time.

Example: If **NAvg=8**, FastCAT averages data from 8 samples (= 1 average/0.5 second) and transmits averaged data real-time.

MinCondFreq=x

x= minimum conductivity frequency (Hz) to enable pump turn-on, to prevent pump from turning on before FastCAT is in water. Pump stops when frequency drops below **MinCondFreq**.

FastCAT Configuration Sheet in manual lists uncorrected (raw) frequency output at 0 conductivity. Typical value (factory-set) for **MinCondFreq** for salt water and estuarine application is: (0 conductivity frequency + 500 Hz). Typical value for **MinCondFreq** for fresh water applications is: (0 conductivity frequency + 5 Hz). Default 3000 Hz.

PumpDelay=x

x= time (seconds) to wait after minimum conductivity frequency (**MinCondFreq**) is reached before turning pump on. Pump delay time allows time for tubing and pump to fill with water after FastCAT is submerged. Pump starts **PumpDelay** seconds after conductivity cell’s frequency output is greater than **MinCondFreq**. Default 30 seconds.

Autonomous Sampling Commands (*continued*)**Notes:**

- See *Real-Time Data Corrections* for detailed explanations of **ProcessRealTime=**, **TAdvance=**, **Alpha=**, and **Tau=**.
- If **ProcessRealTime=Y** but **OutputFormat=0** or **2** (output raw hex or raw decimal data), the status reply shows:

```
real-time temperature and
conductivity correction
enabled, not applied to raw
data,
and the FastCAT does not perform
real-time corrections.
```

ProcessRealTime=x

x= Y: Apply alignment, filtering, and conductivity cell thermal mass corrections to real-time data. Only applies if **OutputFormat=1** or **3**. Default.

x= N: Do not apply corrections to data.

TAdvance=x

x= Time to advance temperature data relative to conductivity and pressure data. Range 0 to 0.125 seconds; default 0.0625 seconds. Only applies if **ProcessRealTime=Y** and **OutputFormat=1** or **3**.

Alpha=x

x= Conductivity cell thermal mass alpha correction. Range 0.02 to 0.05; default 0.03. Only applies if **ProcessRealTime=Y** and **OutputFormat=1** or **3**.

Tau=x

x= Conductivity cell thermal mass tau correction. Range 5.0 to 10.0; default 7.0. Only applies if **ProcessRealTime=Y** and **OutputFormat=1** or **3**.

Note:

After you send **AutoRun=Y**, to start sampling immediately:

- turn power off and then on again, or
- send **Start**.

AutoRun=x

x=N: Wait for a command when power is applied. Default.

x=Y: Start autonomous sampling automatically when power is applied.

Start

Start autonomous sampling now (applicable if **AutoRun=N** or if you just sent **AutoRun=Y**).

Notes:

- You may need to send **Stop** several times to get the FastCAT to respond.
- You can also stop autonomous sampling by clicking the Stop key on the Toolbar, typing Ctrl Z, or removing power.

Stop

Stop autonomous sampling. Press Enter key to get **S>** prompt before entering **Stop**.

Polled Sampling Commands

PumpOn	Turn pump on. Use this command: <ul style="list-style-type: none"> • Before sending TS to obtain pumped conductivity data, or • To test pump.
PumpOff	Turn pump off.
TS	Take 1 sample and transmit data.

Testing Commands

Note:

Testing commands do not automatically turn the pump on. Thus, they report conductivity from essentially the same sample of water for all 100 samples, because the pump does not run and water does not freely flow through the conductivity cell. To get conductivity from fresh samples, send **PumpOn** before sending **TC** or **TCR**, and then send **PumpOff** when the test is complete.

The FastCAT takes and transmits data for 100 samples for each test. Press the Esc key or Stop on the Toolbar to stop a test.

TT	Measure temperature, transmit converted data.
TC	Measure conductivity, transmit converted data.
TP	Measure pressure, transmit converted data.
TTR	Measure temperature, transmit raw data.
TCR	Measure conductivity, transmit raw data.
TPR	Measure pressure, transmit raw data.

Coefficients Commands

DCal

Display calibration coefficients.
Equivalent to Coefficients on Toolbar.

Example: Display coefficients for FastCAT (user input in bold).

```
S>dcal
SBE 49 FastCAT V 1.3a SERIAL NO. 0055
temperature: 26-apr-01
  TA0 = -3.178124e-06
  TA1 = 2.751603e-04
  TA2 = -2.215606e-06
  TA3 = 1.549719e-07
  TOFFSET = 0.000000e+00
conductivity: 26-apr-01
  G = -9.855242e-01
  H = 1.458421e-01
  I = -3.290801e-04
  J = 4.784952e-05
  CPCOR = -9.570000e-08
  CTCOR = 3.250000e-06
  CSLOPE = 1.000000e+00
Pressure S/N = 023674, range = 1000 psia: 25-apr-01
  PA0 = -6.893561e-01
  PA1 = 1.567975e-02
  PA2 = -6.637727e-10
  PTCA0 = 5.246558e+05
  PTCA1 = -4.886082e+00
  PTCA2 = 1.257885e-01
  PTCB0 = 2.489275e+01
  PTCB1 = -8.500000e-04
  PTCB2 = 0.000000e+00
  PTEMPA0 = -6.634546e+01
  PTEMPA1 = 5.093069e+01
  PTEMPA2 = 1.886260e-01
  POFFSET = 0.000000e+00
```

Note:

F = floating point number
S = string with no spaces

Use the commands listed below to modify a particular coefficient or date:

Temperature

TCalDate=S	S=calibration date
TA0=F	F=A0
TA1=F	F=A1
TA2=F	F=A2
TA3=F	F=A3
TOffset=F	F=offset correction

Conductivity

CCalDate=S	S=calibration date
CG=F	F=G
CH=F	F=H
CI=F	F=I
CJ=F	F=J
CPCOR=F	F=pcor
CTCOR=F	F=tcor
CSlope=F	F=slope correction

Pressure

PCalDate=S	S=calibration date
PRange=F	F=sensor full scale range (psia)
POffset=F	F=offset correction (decibars)
PA0=F	F=A0
PA1=F	F=A1
PA2=F	F=A2
PTempA0=F	F=pressure temperature A0
PTempA1=F	F=pressure temperature A1
PTempA2=F	F=pressure temperature A2
PTCA0=F	F=pressure temperature compensation ptca0
PTCA1=F	F=pressure temperature compensation ptca1
PTCA2=F	F=pressure temperature compensation ptca2
PTCB0=F	F=pressure temperature compensation ptcb0
PTCB1=F	F=pressure temperature compensation ptcb1
PTCB2=F	F=pressure temperature compensation ptcb2

Data Output Formats

Note:

See *Baud, Cable Length, and Data Transmission Rate* for the interaction of output format, data transmission rate, baud rate, and cable length.

Output format is dependent on **OutputFormat** (=0, 1, 2, or 3). Each line of data is ended with a carriage return and line feed.

Notes:

- If you will be using Seasave to acquire real-time data, set **OutputFormat=0**.
- For real-time data processing, set **OutputFormat=1** or **3** and **ProcessRealTime=Y**.
- Our software uses the equations shown to perform these calculations; alternatively, use the equations to develop your own processing software. After the data is converted to A/D counts, frequencies, and volts, our software uses the sensor calibration coefficients and the equations on the sensor calibration sheets to convert to engineering units.
- The FastCAT's pressure sensor is an absolute sensor, so its **raw** output includes the effect of atmospheric pressure (14.7 psi). As shown on the Calibration Sheet, Sea-Bird's calibration (and resulting calibration coefficients) is in terms of psia. However, when outputting pressure in **engineering units**, the FastCAT outputs pressure relative to the ocean surface (i.e., at the surface the output pressure is 0 decibars). The FastCAT uses the following equation to convert psia to decibars:

$$\text{Pressure (db)} = [\text{pressure (psia)} - 14.7] * 0.689476$$

OutputFormat=0 (raw data in Hexadecimal)

Data is output in the order listed, with no spaces or commas between parameters. Shown with each parameter is the number of digits, and how to calculate the parameter from the data (use the decimal equivalent of the hex data in the equations).

1. Temperature A/D counts = ttttt
2. Conductivity frequency (Hz) = cccccc / 256
3. Pressure sensor pressure A/D counts = pppppp
4. Pressure sensor temperature compensation voltage = vvvv / 13,107

Example: example scan = tttttccccppppppvvvv = 0A53711BC7220C14C17D82

- Temperature = ttttt = 0A5371 (676721 decimal);
temperature A/D counts = 676721
- Conductivity = cccccc = 1BC722 (1820450 decimal);
conductivity frequency = 1820450 / 256 = 7111.133 Hz
- Pressure = pppppp = 0C14C1 (791745 decimal);
pressure A/D counts = 791745
- Pressure temperature compensation =
vvvv = 7D82 (32,130 decimal);
pressure temperature = 32,130 / 13,107 = 2.4514 volts

OutputFormat=1 (engineering units in Hexadecimal)

Data is output in the order listed, with no spaces or commas between the parameters. Shown with each parameter is the number of digits, and how to calculate the parameter from the data (use the decimal equivalent of the hexadecimal data in the equations).

Note that if **ProcessRealTime=Y**, the output data has been aligned, filtered, and corrected for cell thermal mass effects.

1. Temperature (°C, ITS-90) = (ttttt / 100,000) - 10
2. Conductivity (S/m) = (ccccc / 1,000,000) - 1
3. Pressure (decibars) = (ppppp / 1,000) - 100

Example: example scan = tttttccccppppp = 3385C40F42FE0186DE

- Temperature = ttttt = 3385C4 (3376580 decimal);
temperature (°C, ITS-90) = (3376580 / 100,000) - 10 = 23.7658
- Conductivity = cccccc = 0F42FE (1000190 decimal);
conductivity (S/m) = (1000190 / 1,000,000) - 1 = 0.00019
- Pressure = pppppp = 0186DE (100062 decimal);
pressure (decibars) = (100062 / 1,000) - 100 = 0.062

OutputFormat=2 (raw data in decimal)

Data is output in the order listed, with a comma followed by a space between each parameter. Shown with each parameter are the number of digits and the placement of the decimal point. Leading zeros are suppressed, except for one zero to the left of the decimal point.

1. Temperature A/D counts = ttttt
2. Conductivity frequency (Hz) = cccc.ccc
3. Pressure sensor pressure A/D counts = pppppp
4. Pressure sensor temperature compensation voltage = v.vvvv

Example: example scan = ttttt, cccc.ccc, pppppp, v.vvvv = 676721, 7111.133, 791745, 2.4514

- Temperature = ttttt = 676721;
temperature A/D counts = 676721
- Conductivity = cccc.ccc = 7111.133;
conductivity frequency = 7111.133 Hz
- Pressure = pppppp = 791745;
Pressure A/D counts = 791745
- Pressure temperature compensation = v.vvvv = 2.4514;
Pressure temperature = 2.4514 volts

OutputFormat=3 (engineering units in decimal)

Data is output in the order listed, with a comma followed by a space between each parameter. Shown with each parameter are the number of digits and the placement of the decimal point. Leading zeros are suppressed, except for one zero to the left of the decimal point.

Note that if **ProcessRealTime=Y**, the output data has been aligned, filtered, and corrected for cell thermal mass effects.

1. Temperature (°C, ITS-90) = ttt.tttt
2. Conductivity (S/m) = cc.ccccc
3. Pressure (decibars) = pppp.ppp
4. Salinity (psu) = sss.ssss (if **OutputSal=Y**)
5. Sound velocity (meters/second) = vvvv.vvv (if **OutputSV=Y**)

Example: FastCAT with **OutputSal=N**, **OutputSV=N**

example scan = ttt.tttt, cc.ccccc, pppp.ppp = 23.7658, 0.00019, 0.062

- Temperature = ttt.tttt = 23.7658;
temperature (°C, ITS-90) = 23.7658
- Conductivity = cc.ccccc = 0.00019;
conductivity (S/m) = 0.00019
- Pressure = pppp.ppp = 0.062;
pressure (decibars) = 0.062

Optimizing Data Quality

This section contains guidelines for obtaining the best quality data. Some of these guidelines may conflict with the goals of a particular application, but you should be aware of the tradeoffs of data quality vs. mission goals.

Expelling Air from Plumbing for Optimal Pump Operation

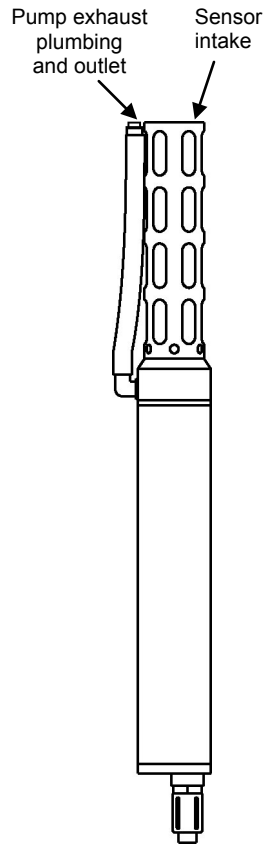

Upcast Data

If performing a **single vertical profile from above the surface**, and wanting to obtain **upcast** data, optimal orientation is vertical, sensors-up. This provides a U-shape to the system plumbing, allowing air to be quickly expelled during a brief soak period just below the surface, ensuring proper pump operation for the entire cast. If FastCAT is oriented so that air cannot be easily expelled, the top 10 meters of data is suspect because the pump may not be operating properly until the air bubbles are collapsed due to water pressure. This may not be an issue if performing a deep cast, because air bubbles will collapse long before upcast begins.

The U-shape and the FastCAT's good seals, combined with optimal pump operation, can prevent surface oils and other contaminants from getting into the plumbing and conductivity cell. **These oils and contaminants are the primary cause of calibration drift in conductivity sensors.** Pump operation to prevent intrusion of surface oils and contaminants follows:

1. On Deployment -
When not in use, store the FastCAT dry (see *Section 5: Routine Maintenance and Calibration*). Fill the cell with a 0.1% solution of Triton 1 hour before deployment. **Deploy the FastCAT without removing the Triton solution.** As the FastCAT breaks the surface, oils and other surface contaminants will *float* on the Triton solution at the intake and exhaust, preventing contaminants from getting into the plumbing and conductivity cell. Hold the FastCAT below the surface until the pump turns on, expelling the Triton solution and drawing in seawater.
2. On Recovery -
Turn off the pump before the FastCAT reaches the surface (if sampling autonomously, stop sampling to turn off the pump). Water will be held in the U-shaped plumbing. As the FastCAT breaks the surface, oils and other surface contaminants will *float* on the water at the intake and exhaust, preventing contaminants from getting into the plumbing and conductivity cell. Turn over the FastCAT when it is on deck, emptying the water from the conductivity cell and exhaust plumbing, so the oil floating on the intake and exhaust surfaces does not get into the system.

Downcast Data

If performing a **single vertical profile from above the surface**, and wanting to obtain **downcast** data, optimal orientation is horizontal, with the temperature sting at the bottom. This provides an upward path to the system plumbing, allowing air to be quickly expelled during a brief soak period just below the surface, ensuring proper pump operation for the entire cast. If the FastCAT is oriented so that air cannot be easily expelled, the top 10 meters of data is suspect because the pump may not be operating properly until the air bubbles are collapsed due to water pressure.

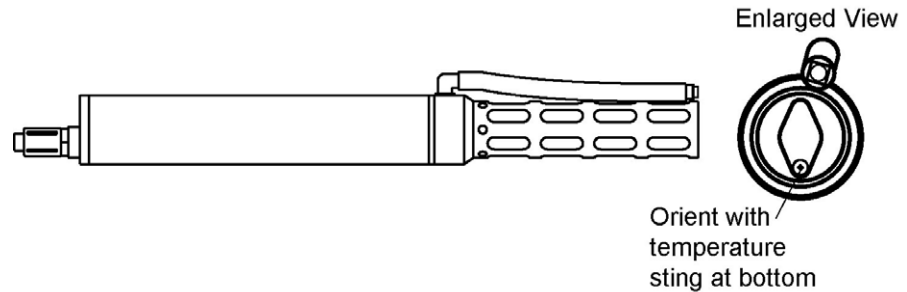

Upcast or Downcast Data, Many Profiling Cycles

For deployments where the FastCAT will be seeing many profiling cycles without breaking the surface, the issue of orientation for optimal pump performance may not be critical. The FastCAT may be taking many tens or hundreds of profiles, and only the data for the shallow part of the first profile would be affected by air in the plumbing. Examples of this type of deployment are a towing operation or a FastCAT deployed on an ROV or AUV.

Directing Exhaust away from Intake vs. Equalizing Bernoulli Pressures

It is important to direct the exhaust water away from the intake water. Exhaust water that mixes with / contaminates the intake water will cause errors in the temperature data, because the pump transfers heat to the exhaust water.

However, there is another consideration in determining how to direct the exhaust. For fast moving applications, it is important to equalize the Bernoulli pressures on the intake and exhaust by placing the intake and exhaust on the same plane, minimizing acceleration of water in the plumbing. Water acceleration in the plumbing overrides the constant flow provided by the pump, resulting in temperature and conductivity data that can be difficult to align because of changing flow rates.

- **For fast moving applications (> 0.5 m/sec):**

The potential for errors caused by mixing of intake and exhaust water are small compared to Bernoulli pressure errors at these speeds. The **straight** fitting (as shipped) minimizes Bernoulli pressure errors. In addition, at these speeds the exhaust flow will be *blown back* as the package moves forward, reducing the mixing of intake and exhaust waters.

- **For slow moving applications (< 0.5 m/sec):**

Bernoulli pressure errors are small compared to errors caused by mixing of the intake and exhaust water at these speeds. The **tee** fitting (as provided in the spares kit that ships with the FastCAT) directs the exhaust path perpendicular to the FastCAT axis, minimizing mixing of the intake and exhaust water.

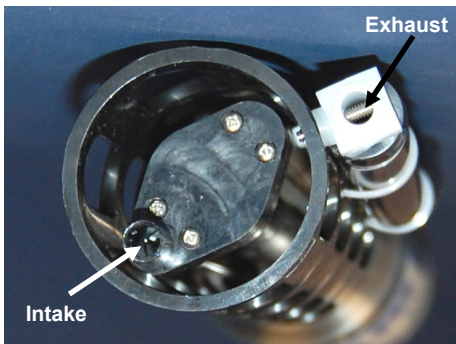

FastCAT with straight exhaust fitting

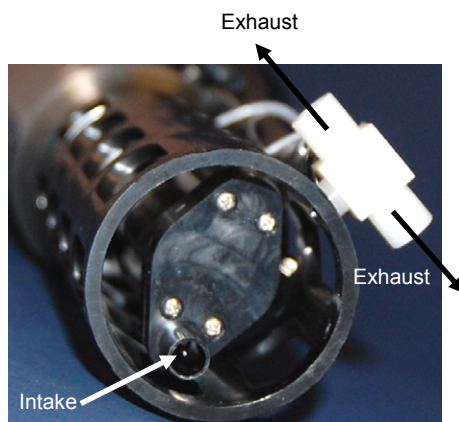

FastCAT with exhaust tee fitting

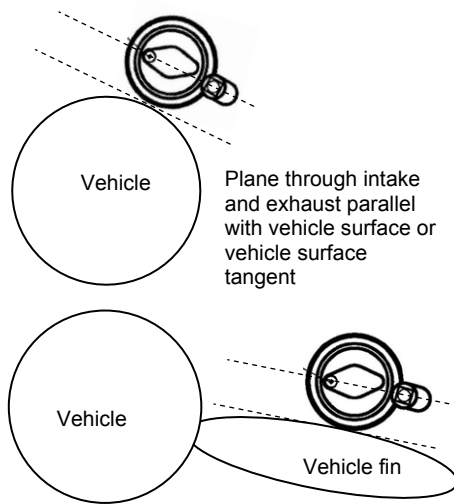

Equalizing Pressures when Mounted on a Vehicle

An object moving through water has a large pressure gradient around the vehicle and/or any major protuberances. As in the discussion of equalizing Bernoulli pressures with respect to the exhaust fitting, if the intake and exhaust *see* a different pressure, there will be acceleration of the water in the plumbing; acceleration in the plumbing overrides the constant flow provided by the pump, resulting in temperature and conductivity data that can be difficult to align because of changing flow rates.

Therefore, it is important to mount the FastCAT to the vehicle (AUV, ROV, etc.) so that the plane that passes through the axis of the intake and exhaust is parallel to the major surface that the FastCAT mounts to. Two examples of appropriate mounting schemes are shown at left.

Profiling Speed when Profiling from a Ship

A profiling speed of approximately 1 meter/second usually provides good quality data. However, the amount of ship motion, and the dynamic effect it has on data quality, must be considered as operating conditions change. In rough seas or other conditions (small boats) where the ship's dynamic motion is large, increase the profiling speed to as much as 2 to 3 meters/second to reduce dynamic errors (spiking) caused by the rapidly changing ascent/descent rate of the FastCAT (yo-yo effect).

In an unpumped CTD, slow profiling speeds can cause reduced flushing of the conductivity cell, and *salinity spiking* can be severe in areas of strong temperature gradients. **Since the FastCAT's pump creates and maintains a constant and optimum flow, the FastCAT can be raised slowly to give greater vertical resolution in the data**, especially on lakes or protected bays, or in other calm conditions. Adjust the ascent rate according to the amount of ship motion (i.e., sea state). On a very calm lake, 10 cm/second is feasible if used with a constant winch speed.

Spiking is sometimes seen in the derived values for salinity, density, or sound velocity. Spiking results largely from a response time mismatch of the conductivity and temperature sensors, especially when the profiling rate is non-uniform. The amount of spiking depends on the temperature gradient, and is much worse when coupled surface motion causes the instrument to stop - or even reverse - its descent. In the event of heavy ship motion, it may be worth letting the instrument *free-fall*. When very heavy seas cause severe ship motion and result in periodic reversals of the instrument descent, the data set can be greatly improved by removing scans taken when the pressure is not increasing.

Positioning Relative to Other Instruments and Package

Position the FastCAT so that other instruments and hardware do not thermally contaminate the water that flows past the sensors. Position the FastCAT forward of or at the front of the package.

Temperature Equilibration

Where water temperature is very different from the temperature at which the FastCAT has been stored, better results are obtained if the FastCAT is allowed to equilibrate to the water temperature at the surface (soak) for several minutes before beginning a profile. The reason is not that the electronics are temperature sensitive - they are not - but that the thermal influence of the instrument housing on the water entering the cell will be reduced. If the difference between water and storage temperature is extreme, allow more *soak time*.

Notes:

- The FastCAT performs real-time alignment of conductivity and temperature data if **ProcessRealTime=Y** and **OutputFormat=1** or **3**.
- See the SBE Data Processing Help files and/or manual for information on data processing modules that can align conductivity and temperature data, and correct data for the influences of ship motion and minimize salinity spiking.

Setup for Deployment

Program the FastCAT for the intended deployment using Seaterm (see *Command Descriptions*).

Note:

See *Acquiring and Processing Data with Seasave and SBE Data Processing*.

- Seasave, our real-time data acquisition program, generates a data file with data format and header information that is compatible with our SBE Data Processing post-processing software. If the FastCAT will be connected directly to the computer or to an SBE 33 or 36 Deck Unit and you will be using **Seasave** to acquire and view real-time data, you must set **OutputFormat=0** (output raw hexadecimal data).
- If the FastCAT will be connected directly to the computer and you will be using **Seaterm** to view real-time data, you must press Capture on the Toolbar to save the data to a .cap file. Note that Seaterm **does not** generate a data file that is compatible with SBE Data Processing. For ease in viewing data, set **OutputFormat=3** (output decimal engineering units).
- If the FastCAT will be connected to an **ROV, AUV**, etc., the vehicle must include a **data logger** for the FastCAT data. Typically, this data will not be in a format that is compatible with SBE Data Processing. However, if the data logger saves **all** the FastCAT data (complete time series) to a verbatim (unaltered) file, preserving the exact data format output by the FastCAT, the file can be processed with SBE Data Processing, after some additional file manipulation to add required header information. To generate a file that you can ultimately use in SBE Data Processing, you must set **OutputFormat=3** (output decimal engineering units).

Note:

See *Acquiring Real-Time Data with ROV, AUV, etc. for Processing by Sea-Bird Software*.

Deployment

CAUTIONS:

- Do not use WD-40 or other petroleum-based lubricants, as they will damage the connectors.
- For wet-pluggable MCBH connectors: **Silicone lubricants in a spray can** may contain ketones, esters, ethers, alcohols, or glycols in their propellant. **Do not use these sprays, as they will damage the connector.**

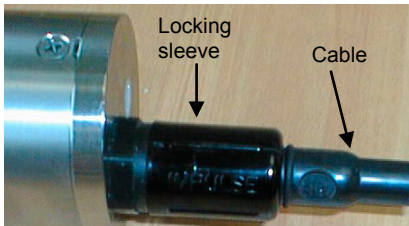

1. Install the data I/O cable on the FastCAT end cap:
 - A. Lightly lubricate the inside of the cable connector with silicone grease (DC-4 or equivalent).
 - B. **XSG Connector** - Install the cable connector, aligning the raised bump on the side of the cable connector with the large pin (pin 1 - ground) on the FastCAT. Remove any trapped air by *burping* or gently squeezing the connector near the top and moving your fingers toward the end cap. **OR**
MCBH Connector – Install the cable connector, aligning the pins.
 - C. Place the locking sleeve over the cable connector and tighten it finger tight only. **Do not overtighten the locking sleeve and do not use a wrench or pliers.**

2. Connect the I/O cable to the computer/controller.
3. Connect the I/O cable connector's red (+) and black (-) wires to a power supply (9-24 VDC).
4. Verify that the hardware and external fittings are secure.

Note:

See *Optimizing Data Quality* above for guidelines on use of the straight fitting vs. the tee fitting.

5. If plugs were placed on the end of the T-C Duct and exhaust fitting to keep dust, debris, etc. out of the conductivity cell during storage, remove the plugs.

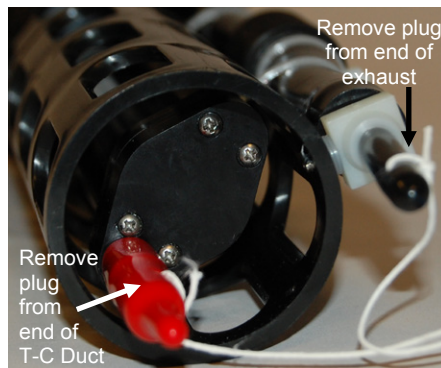

FastCAT with straight exhaust fitting, shown with plugs on

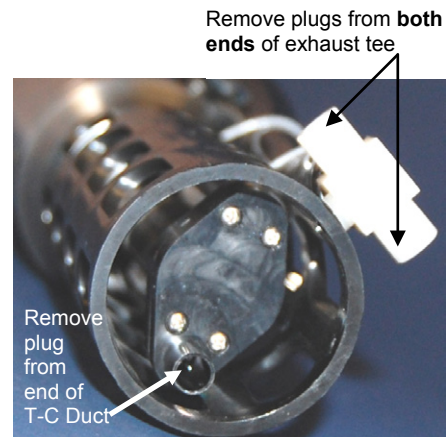

FastCAT with tee exhaust fitting, shown with plugs removed

6. Immediately prior to deployment, apply power and start sampling:
 - If **AutoRun=Y**, applying power started FastCAT sampling.
 - If **AutoRun=N**, send **Start** (in Seaterm).

Acquiring and Processing Data with Seasave and SBE Data Processing

Notes:

- Seasave and SBE Data Processing versions 7.20a introduced .xmlcon files (in XML format). Versions 7.20a and later allow you to open a .con or .xmlcon file, and to save it to a .con or .xmlcon file. Seasave and SBE Data Processing use the same file.
- A new or recalibrated CTD ships with a configuration file that reflects the current configuration as we know it. The file is named with the instrument serial number, followed by a .con extension. For example, for a CTD with serial number 2375, Sea-Bird names the file 2375.con. You may rename the file (but not the extension) if desired; this will not affect the results.

Verifying Contents of Configuration (.xmlcon or .con) File

Seasave, our real-time data acquisition and display program, and SBE Data Processing, our data processing software, require a configuration file, which defines the instrument – data output rate, and serial numbers, calibration dates, and calibration coefficients for the sensors (conductivity, temperature, and pressure). Seasave and SBE Data Processing use the information in the configuration file to interpret and process the raw data. **If the configuration file does not match the actual instrument configuration, the software will not be able to interpret and process data correctly.**

- Double click on Seasave.exe.
- Click Configure Inputs. On the Instrument Configuration tab, click *Open*. In the dialog box, select the .xmlcon or .con file and click Open.
- The configuration information appears on the Instrument Configuration tab. Click Modify to bring up a dialog box (shown below) to change the configuration and/or to view / modify calibration coefficients.
- Click *Save* or *Save As* to save any changes to the .xmlcon or .con file. Click Exit when done reviewing / modifying the configuration.

- NMEA** - Select if NMEA navigation device used, and select whether NMEA device is connected directly to Deck Unit (SBE 33 or 36) or to computer. You can also append NMEA depth data (3 bytes) and NMEA time data (4 bytes) after Lat/Lon data. Seasave adds current latitude, longitude, and universal time code to data header; appends NMEA data to every scan; and writes NMEA data to .nav file every time Ctrl F7 is pressed or Add to .nav File is clicked. Note: NMEA time can only be appended if NMEA device connected to computer.
- Surface PAR** – Select if using with deck unit connected to Surface PAR sensor. Seasave appends Surface PAR data to every scan. Adds 2 channels to Channel/Sensor table. See Application Note 47.

Configuration for the SBE 49 Fastcat CTD

Configuration file opened: None

Scans to average: 1

Number of samples to average per scan. FastCAT samples at 16 Hz (0.0625 seconds), averages data, and transmits averaged data real-time. Must agree with SBE 49 setup (**NAvg=**); see reply from DS.

NMEA position data added NMEA depth data added

NMEA device connected to deck unit NMEA time added

NMEA device connected to PC

Surface PAR voltage added

Scan time added

Select to have Seasave append time (seconds since January 1, 1970 GMT) to each data scan.

Channel	Sensor
1. Count	Temperature
2. Frequency	Conductivity
3. Count	Pressure, Strain Gauge

New to create new .xmlcon or .con file for this CTD.
Open to select different .xmlcon or .con file.
Save or **Save As** to save current .xmlcon or .con file settings.

Click a sensor and click **Modify** to change calibration coefficients for that sensor.

Buttons: Report... Help... Exit Cancel

Acquiring Real-Time Data with Seasave

Instructions below are for a FastCAT used without a Sea-Bird Deck Unit.

If using the FastCAT with the SBE 33 or 36 Deck Unit, see the applicable Deck Unit manual.

1. Start FastCAT sampling:
 - If **AutoRun=Y**: Turn on power. FastCAT will start sampling and transmitting data to the computer.
 - If **AutoRun=N**: Turn on power. Run Seaterm, command the FastCAT to start sampling (**Start**), click Seaterm's Disconnect button, and then close Seaterm.

Note that the data will not appear in Seasave until you tell Seasave to start real-time data acquisition below.

Note:

The baud rate between the FastCAT and computer (defined in Configure Inputs, on the Serial Ports tab) must match the baud rate set in the FastCAT with **Baud=**.

2. Double click on Seasave.exe.
3. Perform any desired setup in the Configure Inputs, Configure Outputs, and Display menus. .
4. In the Real-Time Data menu, select *Start*. The dialog box looks like this:

Data Archiving Options:

- **Begin archiving data immediately** to store raw (frequencies, A/D counts, and/or voltages) real-time data as soon as Start button is clicked and communication is established.
- **Begin archiving data when 'Start Archiving' command is sent** to control when data begins to be written to file. This allows you to eliminate scans associated with deploying CTD from ship deck and soaking instrument near surface (alternatively, remove these scans later in SBE Data Processing). If you make this selection, when you click Start button and communication is established, a dialog box with Start Archiving button appears. Click this button when ready to begin saving scans to file, or select Start Archiving in Real-Time Data menu.
- **Do not archive data for this cast** to not save data to a file. Real-time data will still appear in displays.

Configuration Options: Currently selected instrument configuration (.xmlcon or .con) file is shown, containing information on calibration coefficients for FastCAT's sensors. To modify input configuration (.xmlcon or .con file, serial ports, TCP/IP ports, and/or miscellaneous), click Configure Inputs. To modify outputs (serial data output, serial ports, shared file output, mark variables, TCP/IP output, TCP/IP ports, SBE 14 remote display, PC alarms, header form, and/or diagnostics), click Configure Outputs.

- **Timeout in seconds at startup:** Time allowed before first data scan is received from FastCAT. Seasave will *time out* and stop attempting to acquire data if data is not received from FastCAT within this time period.
- **Timeout in seconds between scans:** Maximum **gap** allowed between scans after first data scan is received from FastCAT. Seasave will *time out* and stop attempting to acquire data if data is not received from FastCAT within this time period (for example, if a shark bites cable and interrupts data acquisition, Seasave stops attempting to acquire data after this gap).

Start Real-Time Data Acquisition

Data Archiving Options

Begin archiving data immediately

Begin archiving data when 'Start Archiving' command is sent

Do not archive data for this cast

Output data [.HEX] file

C:\Documents and Settings\bdbresko\My Documents\test.hex

Select Output Data File Name

Click **Select Output Data File Name**. Save Archived Data As dialog box appears; browse to desired file location, enter desired file name, and click Save.

Configuration Options

Instrument configuration [.xmlcon or .con] file: (to change select Configure Inputs)

C:\Documents and Settings\bdbresko\My Documents\test.xmlcon

Configure Inputs Configure Outputs

Timeout in seconds at startup 60

Timeout in seconds between scans 20

Report Help Start Exit Cancel

5. In the Start Real-Time Data Acquisition dialog box, click *Start*.
 - A. If you selected *Begin archiving data immediately* or *Begin archiving data when 'Start Archiving' command is sent* above, and selected *Prompt for Header Information* in the Header Form setup (Configure Outputs), the Header Information dialog box appears. Fill in the desired header and click OK.
 - B. If you selected *NMEA position data added* in the .xmlcon or .con file, Seasave initializes NMEA communications.
 - C. If you selected *Check Scan Length* in the Options menu, Seasave checks the .xmlcon or .con file to verify that the scan length defined by the configuration file matches the FastCAT (i.e., inclusion of *Scan time added* and inclusion of NMEA is as defined in the file). If a *Scan length error* appears, verify that:
 - You are using the correct .xmlcon or .con configuration file.
 - The configuration file has been updated as necessary if you added or deleted NMEA.
 - D. Seasave sends a message: *Waiting for data . . . Seasave times out* if data is not received within *Timeout in seconds at startup*.
 - E. Real-time data then starts appearing in the screen displays.
6. To stop real-time data acquisition: In the Real-Time Data menu, select *Stop*.
7. Stop sampling:
 - If **AutoRun=Y**: Remove external power.
 - If **AutoRun=N**: Close Seasave, then open Seaterm and send **Stop**.

Processing Data with SBE Data Processing

Note:

See the SBE Data Processing manual and/or Help files.

1. In SBE Data Processing's File menu, select Data Conversion to convert the raw hex (.hex) data file to engineering units (.cnv file).
 - Data Conversion and some other processing modules require the instrument configuration (.xmlcon or .con) file for input. See *Verifying Contents of Configuration (.xmlcon or .con) File* above for a description of the configuration file, which is used in both Seasave and in SBE Data Processing.
2. The .cnv file can be further processed and plotted in SBE Data Processing's other modules.

Acquiring Real-Time Data with ROV, AUV, etc. for Processing by Sea-Bird Software

Note:

You can perform additional processing in SBE Data Processing even if you already aligned, filtered, and corrected for cell thermal mass using the FastCAT's real-time data processing capability (**ProcessRealTime=Y**). For example, you may want to remove *loops* caused by pressure reversals (ship heave), derive additional parameters such as density, bin average the data, or plot the data.

Sea-Bird's SBE Data Processing post-processing software typically converts a FastCAT .hex file from Seasave to a .cnv file, and then uses the .cnv file in all additional processing steps. A method to obtain data in the appropriate format for SBE Data Processing, when data is logged to an ROV, AUV, etc. instead of acquired with Seasave, is presented below. This method requires an ROV, AUV, etc. to save **all** the FastCAT data (complete time series) to a verbatim (unaltered) file, preserving the exact data format output by the FastCAT:

1. Verify that the FastCAT is set to **OutputFormat=3** (output decimal engineering units) and **AutoRun=Y** (begin sampling when power is applied).
2. Begin sampling (turn on power to FastCAT).
3. Stop sampling (turn off power to FastCAT).
4. Recover the FastCAT data file from the ROV, AUV, etc.
5. Open the data file with a text editor (such as Wordpad, Notepad, or Word). Delete any command lines (lines with S> prompt on them) and any lines with partial scans. Save the file as a text (.txt) file and close the file.
6. Rename the .txt file with a .asc extension (for example, test.rov was saved as test.txt, and then renamed as test.asc).
7. In SBE Data Processing's File menu, select ASCII In. Select the .asc file as the input file, and enter the desired output (.cnv) file name. On the Data Setup tab, enter the scan interval (0.0625 seconds for 16 Hz data, 0.125 seconds for 8 Hz data, etc.). Click Select Column Names, and select:
 - A. Column 1 - Temperature [ITS-90, deg C]
 - B. Column 2 - Conductivity [S/m]
 - C. Column 3 - Pressure, Strain Gauge [db]
 - D. Column 4 - Salinity [psu] (if **OutputSal=Y**)
 - E. Column 5 - Sound Velocity [Chen-Millero, m/s] (if **OutputSV=Y**)
 Click Start Process. ASCII In will create a .cnv file from the input .asc file and the information on the Data Setup tab.
8. Use other modules in SBE Data Processing to further process and plot the .cnv file as desired. Note that some processing modules require the instrument configuration (.xmlcon or .con) file as well as the data file for input. See *Verifying Contents of Configuration (.xmlcon or .con) File* in *Acquiring and Processing Data with Seasave and SBE Data Processing* above for a description of the configuration file, which is used in both Seasave and SBE Data Processing.

Note

If **OutputSal=N** and **OutputSV=Y**, select sound velocity for column 4.

Recovery

WARNING!

If the FastCAT stops working while underwater, is unresponsive to commands, or shows other signs of flooding or damage, carefully secure it away from people until you have determined that abnormal internal pressure does not exist or has been relieved. Pressure housings may flood under pressure due to dirty or damaged o-rings, or other failed seals. When a sealed pressure housing floods at great depths and is subsequently raised to the surface, water may be trapped at the pressure at which it entered the housing, presenting a danger if the housing is opened before relieving the internal pressure. Instances of such flooding are rare. However, a housing that floods at 5000 meters depth holds an internal pressure of more than 7000 psia, and has the potential to eject the end cap with lethal force. A housing that floods at 50 meters holds an internal pressure of more than 85 psia; this force could still cause injury.

If you suspect the FastCAT is flooded, point it in a safe direction away from people, and loosen the bulkhead connector very slowly, at least 1 turn. This opens an o-ring seal under the connector. Look for signs of internal pressure (hissing or water leak). If internal pressure is detected, let it bleed off slowly past the connector o-ring. Then, you can safely remove the end cap.

Rinse the conductivity cell with fresh water. (See *Section 5: Routine Maintenance and Calibration* for cell cleaning and storage.)

- Place Tygon tubing over the end of the T-C Duct. Pour the water through the Tygon, conductivity cell, and exhaust tubing with a syringe or wash bottle.

Editing Raw Data File

Sometimes users want to edit the raw .hex data file before beginning processing, to remove data at the beginning of the file corresponding to instrument *soak* time, remove blocks of bad data, edit the header, or add explanatory notes .

Editing the raw .hex file can corrupt the data, making it impossible to perform further processing using Sea-Bird software. Sea-Bird strongly recommends that you first convert the data to a .cnv file (using the Data Conversion module in SBE Data Processing), and then use other SBE Data Processing modules to edit the .cnv file as desired.

Note:

Although we provide this technique for editing a raw .hex file, **Sea-Bird's strong recommendation, as described above, is to always convert the raw data file and then edit the converted file.**

The procedure described below for editing a .hex data file has been found to work correctly on computers running Windows 98, 2000, and NT. **If the editing is not performed using this technique, SBE Data Processing may reject the edited data file and give you an error message.**

1. **Make a back-up copy of your .hex data file before you begin.**
2. Run **WordPad**. In the File menu, select Open. The Open dialog box appears. For *Files of type*, select *All Documents (*.*)*. Browse to the desired .hex file and click Open.
3. Edit the file as desired, **inserting any new header lines after the System Upload Time line**. Note that all header lines must begin with an asterisk (*), and *END* indicates the end of the header. An example is shown below (for an SBE 21), with the added lines in bold:

```
* Sea-Bird SBE 21 Data File:
* FileName = C:\Odis\SAT2-ODIS\oct14-19\oc15_99.hex
* Software Version Seasave Win32 v1.10
* Temperature SN = 2366
* Conductivity SN = 2366
* System Upload Time = Oct 15 1999 10:57:19
* Testing adding header lines
* Must start with an asterisk
* Place anywhere between System Upload Time & END of header
* NMEA Latitude = 30 59.70 N
* NMEA Longitude = 081 37.93 W
* NMEA UTC (Time) = Oct 15 1999 10:57:19
* Store Lat/Lon Data = Append to Every Scan and Append to .NAV
File When <Ctrl F7> is Pressed
** Ship:          Sea-Bird
** Cruise:        Sea-Bird Header Test
** Station:
** Latitude:
** Longitude:
*END*
```
4. In the File menu, select Save (**not Save As**). If you are running Windows 2000, the following message displays:
You are about to save the document in a Text-Only format, which will remove all formatting. Are you sure you want to do this?
Ignore the message and click *Yes*.
5. In the File menu, select Exit.

Section 5:

Routine Maintenance and Calibration

This section reviews corrosion precautions, connector mating and maintenance, conductivity cell storage and cleaning, pressure sensor maintenance, O-ring maintenance, plastic housing handling instructions, replacing optional AF24173 Anti-Foulant Devices, and sensor calibration. The accuracy of the FastCAT is sustained by the care and calibration of the sensors and by establishing proper handling practices.

Corrosion Precautions

Rinse the FastCAT with fresh water after use and prior to storage.

All exposed metal is titanium; other materials are plastic. No corrosion precautions are required, but direct electrical connection of the titanium to dissimilar metal hardware should be avoided.

Connector Mating and Maintenance

Note:

See *Application Note 57: Connector Care and Cable Installation*.

Clean and inspect connectors, cables, and dummy plugs before every deployment and as part of your yearly equipment maintenance. Inspect connectors that are unmated for signs of corrosion product around the pins, and for cuts, nicks or other flaws that may compromise the seal.

When remating:

1. Lightly lubricate the inside of the dummy plug/cable connector with silicone grease (DC-4 or equivalent).
2. **XSG Connector** - Install the plug/cable connector, aligning the raised bump on the side of the plug/cable connector with the large pin (pin 1 - ground) on the FastCAT. Remove any trapped air by *burping* or gently squeezing the plug/connector near the top and moving your fingers toward the end cap. **OR**
MCBH Connector – Install the plug/cable connector, aligning the pins.
3. Place the locking sleeve over the plug/cable connector. Tighten the locking sleeve finger tight only. **Do not overtighten the locking sleeve and do not use a wrench or pliers.**

CAUTIONS:

- **Do not use WD-40** or other petroleum-based lubricants, as they will damage the connectors.
- For wet-pluggable MCBH connectors: **Silicone lubricants in a spray can** may contain ketones, esters, ethers, alcohols, or glycols in their propellant. **Do not use these sprays, as they will damage the connector.**

Verify that a cable or dummy plug is installed before deployment.

Conductivity Cell Maintenance

CAUTIONS:

- **Do not put a brush or any object inside the conductivity cell to dry it or clean it.** Touching and bending the electrodes can change the calibration. Large bends and movement of the electrodes can damage the cell.
- **Do not store the FastCAT with water in the conductivity cell.** Freezing temperatures (for example, in Arctic environments or during air shipment) can break the cell if it is full of water.

The FastCAT's conductivity cell is shipped dry to prevent freezing in shipping. Refer to *Application Note 2D: Instructions for Care and Cleaning of Conductivity Cells* for conductivity cell cleaning procedures and cleaning materials.

Pressure Sensor Maintenance

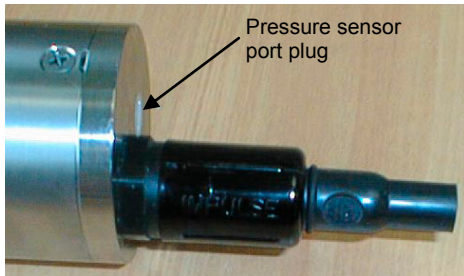

The pressure port plug has a small vent hole to allow hydrostatic pressure to be transmitted to the pressure sensor inside the instrument, while providing protection for the pressure sensor, keeping most particles and debris out of the pressure port.

Periodically (approximately once a year) inspect the pressure port to remove any particles, debris, etc:

1. Unscrew the pressure port plug from the pressure port.
2. Rinse the pressure port with warm, de-ionized water to remove any particles, debris, etc.
3. Replace the pressure port plug.

CAUTION:

Do not put a brush or any object in the pressure port. Doing so may damage or break the pressure sensor.

O-Ring Maintenance

Note:

For details on recommended practices for cleaning, handling, lubricating, and installing O-rings, see the *Basic Maintenance of Sea-Bird Equipment* module in the Sea-Bird training materials: www.seabird.com/training/TrainingHandouts.htm.

O-rings on the FastCAT are typically only disturbed if it is necessary to open the housing for diagnosis and/or repair of an electronics malfunction. Sea-Bird recommends that the O-rings be inspected and replaced approximately every 3 to 5 years.

Remove any water from the O-rings and mating surfaces in the housing with a lint-free cloth or tissue. Inspect O-rings and mating surfaces for dirt, nicks, and cuts. Clean or replace as necessary. Apply a light coat of O-ring lubricant (Parker Super O Lube) to O-rings and mating surfaces.

Handling Instructions for Plastic Housing

The FastCAT's 7000-meter titanium housing offers the best durability with a modest amount of care. A plastic housing saves money and weight. However, more care and caution in handling is required. To get the same excellent performance and longevity for the plastic-housing version, and if you need to access the electronics (not typically done by the customer), observe the following precautions:

- The FastCAT's end caps are retained by screws through the side of the housing. The screw holes are close to the end of the housing. Particularly in a cold environment, where plastic is more brittle, the potential for developing a crack around the screw hole(s) is greater for the plastic housing than for the titanium housing.
Observe the following precautions –
 - When removing end caps (to access the electronics), be careful to avoid any impact in this area of the housing.
 - When reinstalling end caps, do not use excess torque on the screws. Sea-Bird recommends tightening the screws to 15 inch-lbs. Alternatively, tighten the screws finger-tight, and then turn each screw an additional 45 degrees.
- A plastic housing is more susceptible to scratches than a titanium housing. Do not use screwdrivers or other metal tools to pry off the end caps.
 - Of primary concern are scratches on O-ring mating and sealing surfaces. Take extra precaution to avoid a scraping contact with these surfaces when re-seating the end cap.
 - Also take care to keep the O-ring lubricated surfaces clean – avoid trapping any sand or fine grit that can scratch the critical sealing surfaces. If the O-ring lubricant does accumulate any material or grit that can cause a leak or make a scratch, it must be carefully cleaned and replaced with fresh, clean lubricant (Parker Super O Lube).
 - Shallow, external scratches are cosmetic only, and will not affect the performance of the FastCAT. However, deep external scratches can become points of weakness for deep deployments or fracture from impact during very cold weather.

See *Appendix II: Electronics Disassembly / Reassembly* for detailed step-by-step procedures for removing the FastCAT's end caps.

Replacing Optional Anti-Foulant Devices – Mechanical Design Change



Dummy Anti-Foulant Device for intake fitting

The T-C Duct also serves as the anti-foulant device intake fitting. **In the typical configuration (no anti-foulant devices), the intake fitting is shipped with a dummy anti-foulant device (inert plastic) installed to reduce turbulence in the T-C Duct.**

As an option for moored applications, the FastCAT is supplied with an exhaust anti-foulant device fitting and AF24173 Anti-Foulant Devices.

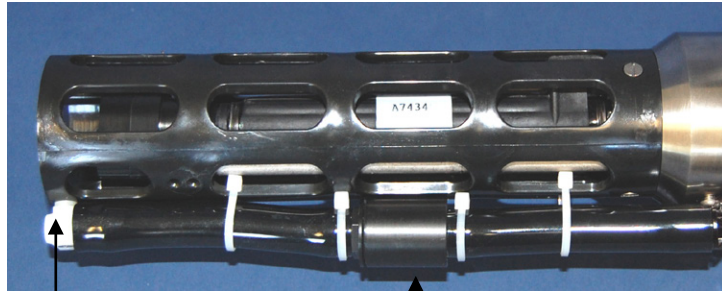
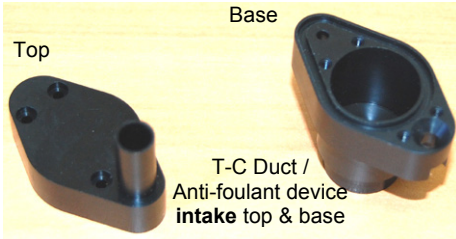

Straight exhaust shown; anti-foulant device fitting detail also applies to FastCAT with Tee exhaust.

Anti-foulant device exhaust cup & cap (optional)

The following two pages provide details on replacing the Anti-Foulant Devices. However, due to a change in the mechanical design of the T-C Duct assembly, Steps 1 – 4 and 7 – 9 in *Anti-Foulant Device in T-C Duct Assembly* are no longer applicable. See the revised details below:

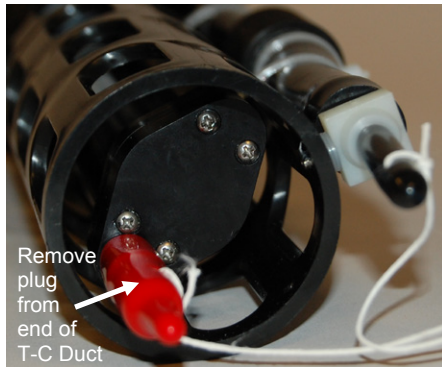

Remove plug from end of T-C Duct

Removing T-C Duct Top (replaces Steps 1 – 4)

- A. Remove the protective plug (if installed) from the end of the T-C duct.
- B. Remove the four small Phillips-head screws with o-rings securing the T-C Duct top to the T-C Duct base.
- C. Carefully pull the T-C Duct top straight out – **do not apply any sideways motion or you may damage the temperature sting.**

Replacing T-C Duct Top (replaces Steps 7 – 9)

- D. Carefully replace the T-C Duct top on the base, reinstalling the four small Phillips-head screws and O-rings.
- E. If the FastCAT is to be stored, reinstall the protective plug in the T-C duct. **Note that the plugs must be removed prior to deployment or pressurization.** If the plugs are left in place during deployment, the cell will not register conductivity. If left in place during pressurization, the cell may be destroyed.

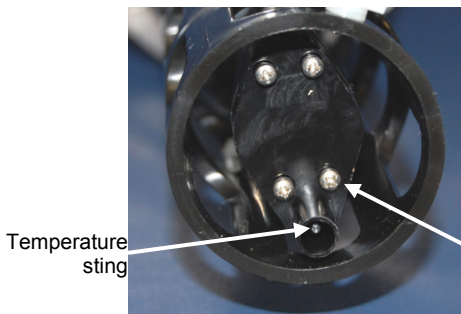

Temperature sting

Phillips-head screws (4) and O-rings, shown partially removed

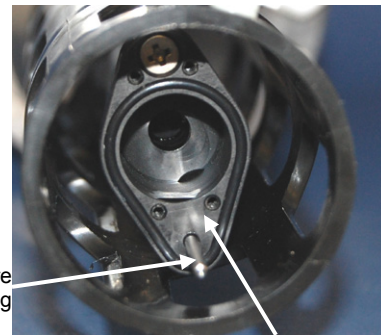

Temperature sting

T-C Duct Base remains attached and sealed to top of conductivity cell - do not remove

Replacing Optional Anti-Foulant Devices (SBE 49)



AF24173
Anti-Foulant
Device

WARNING!

AF24173 Anti-Foulant Devices contain bis(tributyltin) oxide. Handle the devices only with rubber or latex gloves. Wear eye protection. Wash with soap and water after handling.

Read precautionary information on product label (see Appendix IV) before proceeding.

It is a violation of US Federal Law to use this product in a manner inconsistent with its labeling.

As an option, the FastCAT is supplied with anti-foulant device fittings and Anti-Foulant Devices. The Anti-Foulant Devices are installed:

- in the T-C Duct assembly;
- in the anti-foulant device cup and cap (part of the external pump exhaust tubing).

Wearing rubber or latex gloves, follow this procedure to replace each Anti-Foulant Device (two):

Anti-Foulant Device in T-C Duct Assembly

1. Remove the large screw securing the T-C Duct to the mast.
2. Gently pull the T-C Duct straight out - you will feel some resistance as the seals disengage. **Do not twist the T-C Duct or apply any sideways motion, or you may damage the conductivity cell.**
3. Remove the two small Phillips-head screws securing the T-C Duct top to the T-C Duct base.
4. Pull the T-C Duct top off of the base.
5. Remove the old Anti-Foulant Device. If the old device is difficult to remove, use needle-nose pliers and carefully break up material.
6. Place the new Anti-Foulant Device in the T-C Duct base.
7. Replace the T-C Duct top on the base, reinstalling the two small Phillips-head screws.
8. **Carefully** slide the T-C Duct assembly over the temperature sting, aligning the large screw hole with the screw hole in the mast. Push the assembly onto the end of the conductivity cell - you will feel some resistance as the seals engage. **Do not twist the T-C Duct or apply any sideways motion, or you may damage the conductivity cell.**
9. Reinstall the large screw to secure the assembly to the mast.

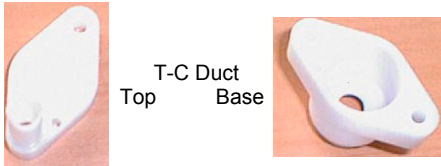

T-C Duct
Top Base

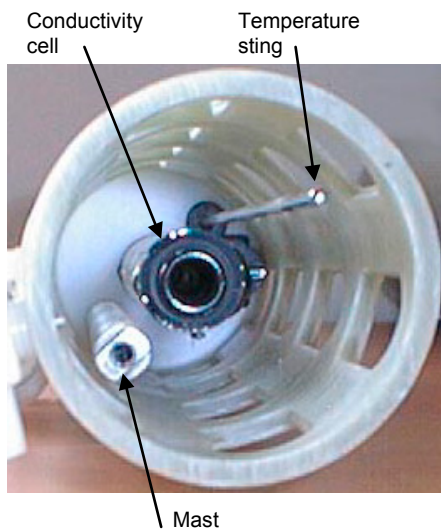

Anti-Foulant Device in Pump Exhaust Tubing

1. Carefully cut the cable tie securing the Tygon tubing to the anti-foulant device cap. Slip the Tygon tubing off of the anti-foulant device cap.
2. Unscrew the cap with a socket wrench.
3. Remove the old Anti-Foulant Device. If the old device is difficult to remove, use needle-nose pliers and carefully break up material.
4. Place the new Anti-Foulant Device in the cup.
5. Rethread the cap onto the cup. Do not over tighten.
6. Slip the Tygon tubing back onto the cap. Secure with a new cable tie.

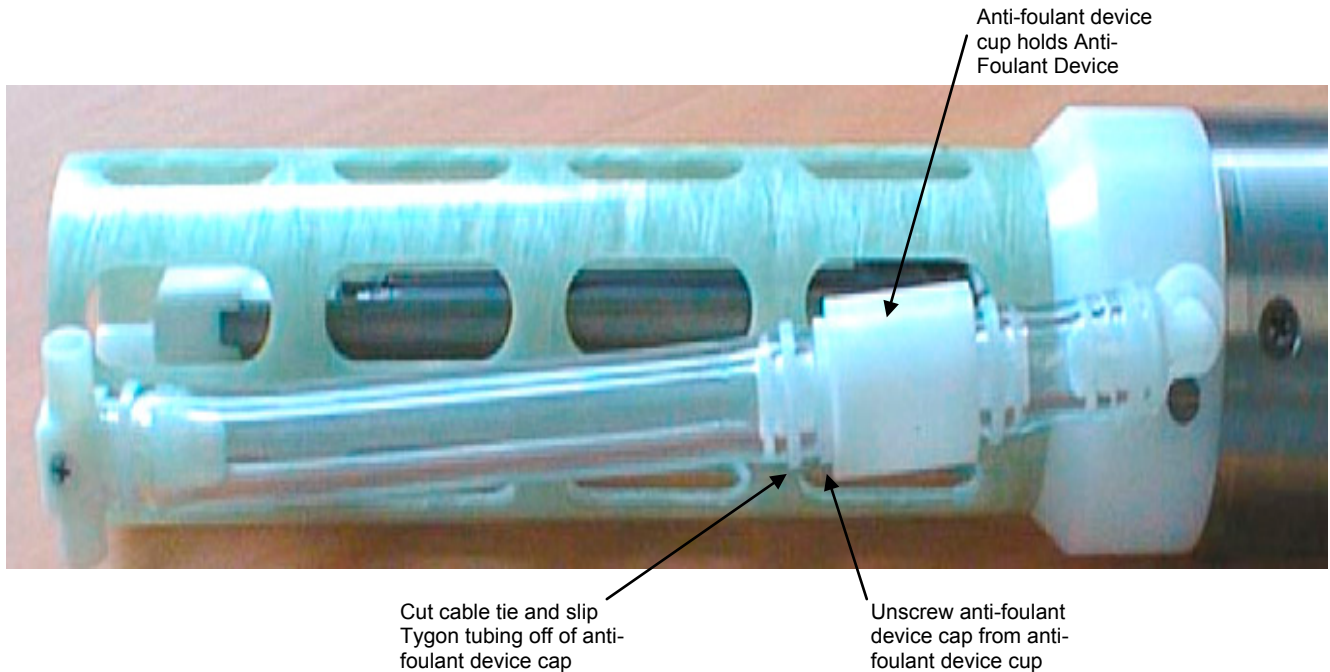

Sensor Calibration

Sea-Bird sensors are calibrated by subjecting them to known physical conditions and measuring the sensor responses. Coefficients are then computed, which may be used with appropriate algorithms to obtain engineering units. The conductivity, temperature, and pressure sensors on the FastCAT are supplied fully calibrated, with coefficients stored in EEPROM in the FastCAT and printed on their respective Calibration Certificates.

Note

After recalibration, Sea-Bird enters the new calibration coefficients in the FastCAT's EEPROM, and ships the instrument back to the user with Calibration Certificates showing the new coefficients. We also ship a new instrument configuration (.con) file, which includes the new coefficients.

We recommend that the FastCAT be returned to Sea-Bird for calibration.

Conductivity Sensor Calibration

The conductivity sensor incorporates a fixed precision resistor in parallel with the cell. When the cell is dry and in air, the sensor's electrical circuitry outputs a frequency representative of the fixed resistor. This frequency is recorded on the Calibration Certificate and should remain stable (within 1 Hz) over time.

The primary mechanism for calibration drift in conductivity sensors is the fouling of the cell by chemical or biological deposits. Fouling changes the cell geometry, resulting in a shift in cell constant.

Accordingly, the most important determinant of long-term sensor accuracy is the cleanliness of the cell. We recommend that the conductivity sensor be calibrated before and after deployment, but particularly when the cell has been exposed to contamination by oil slicks or biological material.

Temperature Sensor Calibration

The primary source of temperature sensor calibration drift is the aging of the thermistor element. Sensor drift will usually be a few thousandths of a degree during the first year, and less in subsequent intervals. Sensor drift is not substantially dependent upon the environmental conditions of use, and — unlike platinum or copper elements — the thermistor is insensitive to shock.

Pressure Sensor Calibration

The FastCAT's strain-gauge pressure sensor is capable of meeting the FastCAT's error specification with some allowance for aging and ambient-temperature induced drift.

Pressure sensors show most of their error as a linear offset from zero. A technique is provided below for making small corrections to the pressure sensor calibration using the *offset* (**POffset=**) calibration coefficient term by comparing FastCAT pressure output to readings from a barometer.

Allow the FastCAT to equilibrate (with power on) in a reasonably constant temperature environment for at least 5 hours before starting. Pressure sensors exhibit a transient change in their output in response to changes in their environmental temperature. Sea-Bird instruments are constructed to minimize this by thermally decoupling the sensor from the body of the instrument. However, there is still some residual effect; allowing the FastCAT to equilibrate before starting will provide the most accurate calibration correction.

Note:

The FastCAT's pressure sensor is an absolute sensor, so its **raw** output includes the effect of atmospheric pressure (14.7 psi). As shown on the Calibration Sheet, Sea-Bird's calibration (and resulting calibration coefficients) is in terms of psia. However, when outputting pressure in **engineering units**, the FastCAT outputs pressure relative to the ocean surface (i.e., at the surface the output pressure is 0 decibars). The FastCAT uses the following equation to convert psia to decibars:
 Pressure (db) =
 $[\text{pressure (psia)} - 14.7] * 0.689476$

1. Place the FastCAT in the orientation it will have when deployed.
2. In Seaterm:
 - A. Set the pressure offset to 0.0 (**POffset=0**).
 - B. Send **TP** to measure the FastCAT pressure 100 times and transmit converted data in engineering units (decibars).
3. Compare the FastCAT output to the reading from a good barometer at the same elevation as the FastCAT's pressure sensor.
 Calculate *offset* = barometer reading – FastCAT reading
4. Enter calculated offset (positive or negative):
 - In the FastCAT's EEPROM, using **POffset=** in Seaterm, **and**
 - In the configuration (.xmlcon or .con) file, using Seasave or SBE Data Processing.

Offset Correction Example

Absolute pressure measured by a barometer is 1010.50 mbar. Pressure displayed from FastCAT is -2.5 dbars. Convert barometer reading to dbars using the relationship: $\text{mbar} * 0.01 = \text{dbar}$
 Barometer reading = 1010.50 mbar * 0.01 = 10.1050 dbar
 The FastCAT's internal calculations and our processing software output gage pressure, using an assumed value of 14.7 psi for atmospheric pressure. Convert FastCAT reading from gage to absolute by adding 14.7 psia to the FastCAT's output:
 $-2.5 \text{ dbars} + (14.7 \text{ psi} * 0.689476 \text{ dbar/psia}) = -2.5 + 10.13 = 7.635 \text{ dbars}$
 Offset = 10.1050 – 7.635 = + 2.47 dbars
 Enter offset in FastCAT and in .xmlcon or .con file.

For demanding applications, or where the sensor's air ambient pressure response has changed significantly, calibration using a dead-weight generator is recommended. This provides more accurate results, but requires equipment that may not be readily available. The end cap's $7/16$ -20 straight thread permits mechanical connection to the pressure source. Use a fitting that has an O-ring tapered seal, such as Swagelok-200-1-4ST, which conforms to MS16142 boss.

Section 6: Troubleshooting

This section reviews common problems in operating the FastCAT, and provides the most likely causes and solutions.

Problem 1: Unable to Communicate with FastCAT in Seaterm (terminal program)

The `S>` prompt indicates that communications between the FastCAT and computer have been established. Before proceeding with troubleshooting, attempt to establish communications again by clicking Connect on Seaterm's toolbar or hitting the Enter key several times.

Cause/Solution 1: The I/O cable connection may be loose. Check the cabling between the FastCAT and computer for a loose connection.

Cause/Solution 2: The instrument type and/or communication settings may be entered incorrectly in Seaterm. Select *SBE 49* in the Configure menu and verify the settings in the Configuration Options dialog box. The settings should match those on the instrument Configuration Sheet in the manual.

Cause/Solution 3: You may be using the wrong cable. The I/O cable supplied with the FastCAT permits connection to standard 9-pin RS-232 interfaces.

- FastCAT pin 1 goes to DB-9 pin 5
- FastCAT pin 2 goes to DB-9 pin 3
- FastCAT pin 3 goes to DB-9 pin 2

See *Section 2: Description of FastCAT* for the connector details.

Problem 2: Seasave Data Acquisition is Cancelled – Timed Out

Cause/Solution 1: The I/O cable connection may be loose. Check the cabling between the FastCAT and computer for a loose connection.

Cause/Solution 2: Seasave may have incorrect communication settings. Connect to the FastCAT in Seaterm to find the correct communication settings and COM port (they appear in the Status bar at the bottom of the window once connected to the instrument). Then disconnect from Seaterm and open Seasave. Check that the communication settings and COM Ports selected on the Serial Ports tab (Configure Inputs or Configure Outputs) are correct.

Problem 3: Unable to View Data in Seasave (Real-Time Data Acquisition program)

Note:

If *Check scan length* is enabled in Seasave's Options menu, Seasave checks the data scan length against the expected length (based on the configuration file setup), and provides a warning that there is an error. Sea-Bird recommends using this setting.

Cause/Solution 1: If the scan length does not match the selected .xmlcon or .con configuration file (for example, the configuration file indicates that NMEA position data is added through a NMEA device connected to the computer, but you did not connect the NMEA device to the computer), **Seasave continues with real-time data acquisition (saving the raw data to a file for later processing), but does not show or plot data in the Seasave displays.** The data quality is not affected; you can correct the configuration file error in SBE Data Processing (post-processing), and process the data as required.

Problem 4: Scan Length Error in SBE Data Processing

Note:

To view the Diagnostics file, select *Diagnostics* in Data Conversion's Options menu. In the Diagnostics dialog box, click on *Display Log File*.

Cause/Solution 1: If the scan length in the data file does not match the selected .xmlcon or .con configuration file (for example, the configuration file indicates that NMEA position data was added, but the data file does not contain NMEA data), SBE Data Processing's Data Conversion module will not process the data. If you look in the Diagnostics file, you will see a *scan length error*. Check the configuration file against the header in the data file, and correct the configuration file as required.

Problem 5: Unreasonable Data

The symptom of this problem is data that contains unreasonable values (for example, values that are outside the expected range of the data).

Cause/Solution 1: Data with unreasonable values may be caused by:

- Incorrect calibration coefficients in the instrument's EEPROM (if looking at data output from the FastCAT in converted format). Verify the calibration coefficients in EEPROM match the instrument Calibration Certificates, using **DCal** in Seaterm.
- Incorrect calibration coefficients in the .xmlcon or .con configuration file (if looking at data in Seasave or SBE Data Processing). Verify the calibration coefficients in the configuration file match the instrument Calibration Certificates.

Problem 6: Salinity Lower than Expected

Cause/Solution 1: A fouled conductivity cell will report lower than correct salinity. Large errors in salinity indicate that the cell is extremely dirty, has something large lodged in it, or is broken. Proceed as follows:

1. Clean the conductivity cell as described in *Conductivity Cell Maintenance* in *Section 5: Routine Maintenance and Calibration*.
2. Remove larger droplets of water by blowing through the conductivity cell. **Do not use compressed air**, which typically contains oil vapor.
3. Running the FastCAT in air, use **TCR** in Seaterm to look at the raw conductivity frequency. It should be within 1 Hz of the zero conductivity value printed on the conductivity cell Calibration Sheet. If it is significantly different, the cell is probably damaged.

Glossary

Note:

All Sea-Bird software listed was designed to work with a computer running Windows XP service pack 2 or later, Windows Vista, or Windows 7.

FastCAT – High-accuracy conductivity, temperature, and pressure sensor.

Fouling – Biological growth in the conductivity cell during deployment.

PCB – Printed Circuit Board.

SBE Data Processing – Sea-Bird’s Win 2000/XP data processing software, which calculates temperature, conductivity, and pressure; derives variables such as salinity and sound velocity; and plots data.

Scan – One data sample containing temperature, conductivity, and pressure.

Seasave V7 – Sea-Bird’s Windows software used to acquire, convert, and display real-time or archived raw data.

Seasoft V2 – Sea-Bird’s complete Windows software package, which includes software for communication, real-time data acquisition, and data analysis and display. Seasoft V2 includes *Seaterm*, *Seasave V7*, *SBE Data Processing*.

Seaterm – Sea-Bird’s Windows terminal program used to communicate with the FastCAT.

Super O-Lube – Silicone lubricant used to lubricate O-rings and O-ring mating surfaces. Super O-Lube can be ordered from Sea-Bird, but should also be available locally from distributors. Super O-Lube is manufactured by Parker Hannifin (www.parker.com/ead/cm2.asp?cmid=3956).

Triton X-100 – Reagent grade non-ionic surfactant (detergent), used for cleaning the conductivity cell. Triton can be ordered from Sea-Bird, but should also be available locally from chemical supply or laboratory products companies. Triton is manufactured by Avantor Performance Materials (www.avantormaterials.com/commerce/product.aspx?id=2147509608).

Appendix I: Functional Description and Circuitry

Sensors

The SBE 49 embodies the same sensor elements (3-electrode, 2-terminal, borosilicate glass cell, and pressure-protected thermistor) previously employed in Sea-Bird's modular SBE 3 and SBE 4 sensors and in the SeaCAT and SeaCAT*plus*. The FastCAT uses three independent channels to digitize temperature, conductivity, and pressure concurrently.

The pressure sensor is a strain-gauge sensor.

Sensor Interface

Temperature is acquired by applying an AC excitation to a bridge circuit containing an ultra-stable aged thermistor with a drift rate of less than 0.002 °C per year. The other elements in the bridge are VISHAY precision resistors. A 24-bit A/D converter digitizes the output of the bridge. AC excitation and ratiometric comparison avoids errors caused by parasitic thermocouples, offset voltages, leakage currents, and reference errors.

Conductivity is acquired using an ultra-precision Wien-Bridge oscillator to generate a frequency output in response to changes in conductivity.

Strain-gauge pressure is acquired by applying an AC excitation to the pressure bridge. A 24-bit A/D converter digitizes the output of the bridge. AC excitation and ratiometric comparison avoids errors caused by parasitic thermocouples, offset voltages, leakage currents, and reference errors. A silicon diode embedded in the pressure bridge is used to measure the temperature of the pressure bridge. This temperature is used to perform offset and span corrections on the measured pressure signal.

Appendix II: Electronics Disassembly/Reassembly

Disassembly

CAUTION:

See *Section 5: Routine Maintenance and Calibration* for handling instructions for the plastic housing.

Remove screw (2 places)
Pry off end cap using screwdriver in slots



Remove screw (3 places)

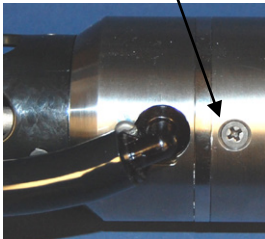

1. Remove the connector end cap:
 - A. Wipe the outside of the end cap and housing dry, being careful to remove any water at the seam between them.
 - B. Remove the 2 Phillips-head screws holding the connector end cap to the housing.
Note: For plastic-housing FastCATs shipped or retrofitted after July 2008, these are hex screws instead of Phillips-head screws. Sea-Bird ships the FastCAT with a 9/64-inch Allen wrench for these screws.
 - C. Using straight screwdrivers in the slots, carefully pry off the end cap. Note that the end cap and electronics are electrically connected with edge connectors, and **the end cap will not twist off**.
 - D. Remove any water from the O-rings and mating surfaces inside the housing with a lint-free cloth or tissue.
 - E. Be careful to protect the O-rings from damage or contamination.
2. Remove the housing:
 - A. Wipe the outside of the sensor end cap and housing dry, being careful to remove any water at the seam between them.
 - B. Remove the 3 Phillips-head screws holding the housing to the sensor end cap.
Note: For plastic-housing FastCATs shipped or retrofitted after July 2008, these are hex screws instead of Phillips-head screws. Sea-Bird ships the FastCAT with a 9/64-inch Allen wrench for these screws.
 - C. Slide the end cap and attached electronics out of the housing.
 - D. Remove any water from the O-rings and mating surfaces inside the housing with a lint-free cloth or tissue.
 - E. Be careful to protect the O-rings from damage or contamination.

Reassembly

Note:

Before delivery, a desiccant package is placed in the housing, and the electronics chamber is filled with dry Argon gas. These measures help prevent condensation. To ensure proper functioning:

1. Install a new desiccant bag each time you open the housing. If a new bag is not available, see *Application Note 71: Desiccant Use and Regeneration (drying)*.
2. If possible, dry gas backfill each time you open the housing. If you cannot, wait at least 24 hours before redeploying, to allow the desiccant to remove any moisture from the housing.

1. Remove any water from the end cap O-rings and mating surfaces in the housing with a lint-free cloth or tissue. Inspect the O-rings and mating surfaces for dirt, nicks, and cuts. Clean or replace as necessary. Apply a light coat of O-ring lubricant (Parker Super O Lube) to the O-rings and mating surfaces.
2. Reinstall the housing:
 - A. Carefully fit the end cap and electronics into the housing until the O-rings are fully seated.
 - B. Reinstall the 3 screws to secure the housing to the sensor end cap.
3. Reinstall the connector end cap:
 - A. Line up the alignment pin with the notch in the end cap. Verify the pin/notch and screw holes are properly aligned.
 - B. Carefully fit the end cap into the housing until the edge connectors mate and the O-rings are fully seated.
 - C. Reinstall the 2 screws to secure the housing to the end cap.
4. No user-programmable setup parameters should have been affected by the electronics disassembly (send **DS** to verify).

Appendix III: Command Summary

CATEGORY	COMMAND	DESCRIPTION
Status	DS	Display status and setup parameters.
Setup	Baud=x	x= baud rate (1200, 2400, 4800, 9600, 19200, or 38400). Default 9600.
	OutputFormat=x	x=0: output raw data in Hex. x=1: output converted data in Hex. x=2: output raw data in decimal. x=3: output converted data in decimal. Default.
	OutputSal=x	x=Y: Calculate and output salinity (psu). Only applies if OutputFormat=3 . Default. x=N: Do not calculate and output salinity.
	OutputSV=x	x=Y: Calculate and output sound velocity (m/sec). Only applies if OutputFormat=3 . Default. x=N: Do not calculate and output sound velocity.
	SetDefaults	Reset to default values: OutputFormat=3, OutputSal=Y, OutputSV=Y, NAvg=1, MinCondFreq=3000, PumpDelay=30, ProcessRealTime=Y, TAdvance=0.0625, Alpha=0.03, Tau=7.0, AutoRun=N.
Autonomous Sampling	NAvg=x	x= number of samples to average. FastCAT samples at 16 Hz and averages NAvg samples. Default =1.
	MinCondFreq=x	x= minimum conductivity frequency (Hz) to enable pump turn-on. Pump stops when frequency drops below x. Default 3000 Hz; factory set to (0 conductivity frequency + 500 Hz).
	PumpDelay=x	x= time (seconds) to wait after minimum conductivity frequency is reached before turning pump on. Default 30 seconds.
	ProcessRealTime=x	x=Y: Apply alignment, filtering, and conductivity cell thermal mass corrections to data. Only applies if OutputFormat=1 or 3 . x=N: Do not apply corrections to data.
	TAdvance=x	x= Time to advance temperature data relative to conductivity and pressure data. Range 0 to 0.125 seconds; default 0.0625 seconds. Only applies if ProcessRealTime=Y and OutputFormat=1 or 3 .
	Alpha=x	x= Conductivity cell thermal mass alpha correction. Range 0.02 to 0.05; default 0.03. Only applies if ProcessRealTime=Y and OutputFormat=1 or 3 .
	Tau=x	x= Conductivity cell thermal mass tau correction. Range 5.0 to 10.0; default 7.0. Only applies if ProcessRealTime=Y and OutputFormat=1 or 3 .
	AutoRun=x	x=N: Wait for command when power applied. Default. x=Y: Start autonomous sampling when power applied.
	Start	Start autonomous sampling now.
Stop	Stop autonomous sampling. Press Enter key to get S> prompt before entering Stop .	
Polled Sampling	PumpOn	Turn pump on.
	PumpOff	Turn pump off.
	TS	Take 1 sample and output data.
Testing Takes and outputs 100 samples for each test. Press Esc key or Stop on Toolbar to stop test.	TT	Measure temperature, transmit converted data.
	TC	Measure conductivity, transmit converted data.
	TP	Measure pressure, transmit converted data.
	TTR	Measure temperature, transmit raw data
	TCR	Measure conductivity, transmit raw data.
TPR	Measure pressure, transmit raw data.	

CATEGORY	COMMAND	DESCRIPTION
Coefficients (F=floating point number; S=string with no spaces) Dates shown are when calibrations were performed. Calibration coefficients are initially factory-set and should agree with Calibration Certificates shipped with FastCAT.	DCal	Display calibration coefficients; all coefficients and dates listed below are included in display. Use individual commands below to modify a particular coefficient or date.
	TCalDate=S	S=Temperature calibration date.
	TA0=F	F=Temperature A0.
	TA1=F	F=Temperature A1.
	TA2=F	F=Temperature A2.
	TA3=F	F=Temperature A3.
	TOffset=F	F=Temperature offset correction.
	CCalDate=S	S=Conductivity calibration date.
	CG=F	F=Conductivity G.
	CH=F	F=Conductivity H.
	CI=F	F=Conductivity I.
	CJ=F	F=Conductivity J.
	CPCOR=F	F=Conductivity pcor.
	CTCOR=F	F=Conductivity tcor.
	CSlope=F	F=Conductivity slope correction.
	PCalDate=S	S=Pressure calibration date.
	PRange=F	F=Pressure sensor full scale range (psia).
	POffset=F	F=Pressure offset correction (decibars).
	PA0=F	F=Pressure A0.
	PA1=F	F=Pressure A1.
	PA2=F	F=Pressure A2.
	PTempA0=F	F=Pressure temperature A0.
	PTempA1=F	F=Pressure temperature A1.
	PTempA2=F	F=Pressure temperature A2.
PTCA0=F	F=Pressure temperature compensation ptca0.	
PTCA1=F	F=Pressure temperature compensation ptca1.	
PTCA2=F	F=Pressure temperature compensation ptca2.	
PTCB0=F	F=Pressure temperature compensation ptcb0.	
PTCB1=F	F=Pressure temperature compensation ptcb1.	
PTCB2=F	F=Pressure temperature compensation ptcb2.	

Appendix IV: AF24173 Anti-Foulant Device

AF24173 Anti-Foulant Devices supplied for user replacement are supplied in polyethylene bags displaying the following label:

AF24173 ANTI-FOULANT DEVICE

FOR USE ONLY IN SEA-BIRD ELECTRONICS' CONDUCTIVITY SENSORS TO CONTROL THE GROWTH OF AQUATIC ORGANISMS WITHIN ELECTRONIC CONDUCTIVITY SENSORS.

ACTIVE INGREDIENT:

Bis(tributyltin) oxide.....	53.0%
OTHER INGREDIENTS:	<u>47.0%</u>
Total.....	100.0%

DANGER

See the complete label within the Conductivity Instrument Manual for Additional Precautionary Statements and Information on the Handling, Storage, and Disposal of this Product.

Net Contents: Two anti-foulant devices

Sea-Bird Electronics, Inc.
13431 NE 20th Street
Bellevue, WA 98005

EPA Registration No. 74489-1
EPA Establishment No. 74489-WA-1

AF24173 Anti-Foulant Device

FOR USE ONLY IN SEA-BIRD ELECTRONICS' CONDUCTIVITY SENSORS TO CONTROL THE GROWTH OF AQUATIC ORGANISMS WITHIN ELECTRONIC CONDUCTIVITY SENSORS.

ACTIVE INGREDIENT:

Bis(tributyltin) oxide.....	53.0%
OTHER INGREDIENTS:	47.0%
Total.....	100.0%

DANGER

See Precautionary Statements for additional information.

FIRST AID	
If on skin or clothing	<ul style="list-style-type: none"> • Take off contaminated clothing. • Rinse skin immediately with plenty of water for 15-20 minutes. • Call a poison control center or doctor for treatment advice.
If swallowed	<ul style="list-style-type: none"> • Call poison control center or doctor immediately for treatment advice. • Have person drink several glasses of water. • Do not induce vomiting. • Do not give anything by mouth to an unconscious person.
If in eyes	<ul style="list-style-type: none"> • Hold eye open and rinse slowly and gently with water for 15-20 minutes. • Remove contact lenses, if present, after the first 5 minutes, then continue rinsing eye. • Call a poison control center or doctor for treatment advice.
HOT LINE NUMBER	
Note to Physician	Probable mucosal damage may contraindicate the use of gastric lavage.
Have the product container or label with you when calling a poison control center or doctor, or going for treatment. For further information call National Pesticide Telecommunications Network (NPTN) at 1-800-858-7378.	

Net Contents: Two anti-foulant devices

Sea-Bird Electronics, Inc.
 13431 NE 20th Street
 Bellevue, WA 98005

EPA Registration No. 74489-1
 EPA Establishment No. 74489-WA-1

PRECAUTIONARY STATEMENTS

HAZARD TO HUMANS AND DOMESTIC ANIMALS

DANGER

Corrosive - Causes irreversible eye damage and skin burns. Harmful if swallowed. Harmful if absorbed through the skin or inhaled. Prolonged or frequently repeated contact may cause allergic reactions in some individuals. Wash thoroughly with soap and water after handling.

PERSONAL PROTECTIVE EQUIPMENT

USER SAFETY RECOMMENDATIONS

Users should:

- Remove clothing immediately if pesticide gets inside. Then wash thoroughly and put on clean clothing.
- Wear protective gloves (rubber or latex), goggles or other eye protection, and clothing to minimize contact.
- Follow manufacturer's instructions for cleaning and maintaining PPE. If no such instructions for washables, use detergent and hot water. Keep and wash PPE separately from other laundry.
- Wash hands with soap and water before eating, drinking, chewing gum, using tobacco or using the toilet.

ENVIRONMENTAL HAZARDS

Do not discharge effluent containing this product into lakes, streams, ponds, estuaries, oceans, or other waters unless in accordance with the requirements of a National Pollutant Discharge Elimination System (NPDES) permit and the permitting authority has been notified in writing prior to discharge. Do not discharge effluent containing this product to sewer systems without previously notifying the local sewage treatment plant authority. For guidance contact your State Water Board or Regional Office of EPA. This material is toxic to fish. Do not contaminate water when cleaning equipment or disposing of equipment washwaters.

PHYSICAL OR CHEMICAL HAZARDS

Do not use or store near heat or open flame. Avoid contact with acids and oxidizers.

DIRECTIONS FOR USE

It is a violation of Federal Law to use this product in a manner inconsistent with its labeling. For use only in Sea-Bird Electronics' conductivity sensors. Read installation instructions in the applicable Conductivity Instrument Manual.

STORAGE AND DISPOSAL

PESTICIDE STORAGE: Store in original container in a cool, dry place. Prevent exposure to heat or flame. Do not store near acids or oxidizers. Keep container tightly closed.

PESTICIDE SPILL PROCEDURE: In case of a spill, absorb spills with absorbent material. Put saturated absorbent material to a labeled container for treatment or disposal.

PESTICIDE DISPOSAL: Pesticide that cannot be used according to label instructions must be disposed of according to Federal or approved State procedures under Subtitle C of the Resource Conservation and Recovery Act.

CONTAINER HANDLING: Nonrefillable container. Do not reuse this container for any other purpose. Offer for recycling, if available.

Appendix V: Real-Time Data Correction Algorithms

Note:

Real-time processing recommendations are summarized in *Real-Time Data Corrections* in *Section 4: Deploying and Operating FastCAT*.

Aligning, filtering, and correcting for conductivity cell thermal mass in post-processing allows you to make adjustments to the measured data before calculating derived parameters. SBE Data Processing, part of our Seasoft suite, can perform this processing on recorded data, if a complete C, T, and P time series is recorded. However, the FastCAT, which samples and transmits data at 16 Hz, is frequently integrated by the customer with an AUV or ROV. The AUV/ROV may record data on command, with uneven time intervals between each recorded measurement. The lack of a true time series from the FastCAT for these applications prevents aligning, filtering, and correcting for cell thermal mass in post-processing.

Therefore, the FastCAT can be programmed to process data in real-time if sampling autonomously. This provides T, C, and P output that is already aligned, filtered, and corrected for cell thermal mass, and also provides calculated and output salinity and sound velocity (if applicable) based on these corrected values.

Cell thermal mass corrections should not be applied to freshwater data. It can give bad results, due to the way the derivative dc/dT is calculated in regions where conductivity changes are small. Currently, the SBE 49 firmware does not permit you to apply just aligning and filtering, without also applying cell thermal mass corrections.

Aligning Data

The FastCAT aligns temperature data in time, relative to conductivity and pressure. This ensures that calculations of salinity, sound velocity, and other derived variables are made using measurements from the same parcel of water.

There are three principal causes of misalignment of CTD measurements:

- physical misalignment of the sensors in depth
- inherent time delay (time constants) of the sensor responses
- water transit time delay in the pumped plumbing line - the time it takes the parcel of water to go through the plumbing to each sensor (or, for free-flushing sensors, the corresponding flushing delay, which depends on profiling speed)

In the FastCAT, temperature data is usually misaligned with respect to conductivity and pressure. Advancing temperature relative to conductivity and pressure can compensate. The recommended temperature advance value for a typical FastCAT is 0.0625 seconds, but the user can select a value ranging from 0 to 0.125 seconds. When measurements are properly aligned, salinity spiking (and density) errors are minimized.

The best diagnostic of proper alignment is the elimination of salinity spikes that coincide with very sharp temperature steps. Some experimentation with different advances is required to find the best alignment. To determine the best alignment for your FastCAT, plot 10 meters of uncorrected temperature and salinity data at a depth that contains a very sharp temperature step. For the downcast, when temperature and salinity decrease with increasing pressure:

- A negative salinity spike at the step means that temperature lags conductivity (temperature sensor *sees* step after conductivity sensor does), and that temperature should be advanced a **positive** number of seconds.
- Conversely, a positive salinity spike means that temperature leads conductivity (temperature sensors *sees* step before conductivity sensor does), and that temperature should be advanced a **negative** number of seconds. Note that this behavior is not expected for a FastCAT, because of the inherent characteristics of the sensor response times and plumbing. Therefore, the FastCAT's real-time data processing does not support a negative temperature advance; see the SBE Data Processing manual to perform this correction in post-processing if necessary.

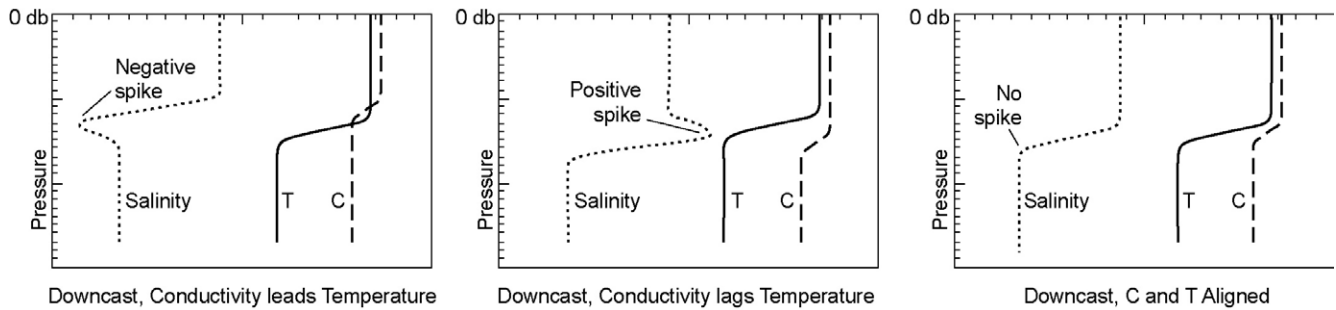

Shown below is a comparison of FastCAT data with different temperature advances; the best results (least salinity spiking) are seen with an **advance of 0.0625 seconds**.

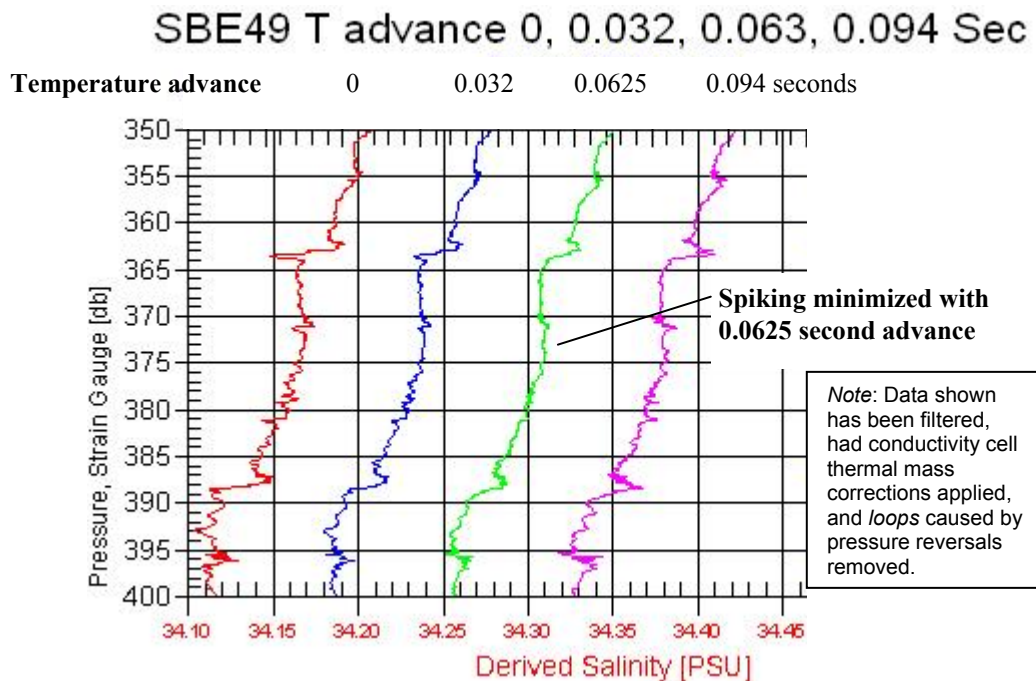

Filtering Data

Filtering smoothes the data, to match the temperature and conductivity sensor time constants. In post-processing, Sea-Bird recommends using a low-pass filter (Filter module in SBE Data Processing) on recorded FastCAT data, with a time constant of 0.085 seconds for both temperature and conductivity. This filter algorithm cannot be implemented for real-time data processing in the FastCAT, because the low-pass filter is run forward through the data (an impossible task when processing in real-time) and then run backward through the data. Instead, a 5-scan cosine window filter (based on the Window Filter module in SBE Data Processing) was implemented for real-time data processing in the FastCAT; this window filter provides results comparable to the low-pass filter.

The window filter calculates a weighted average of data values about a center point, using the following transfer function:

$$y(n) = \sum_{k=-L/2}^{L/2} w(k) x(n-k)$$

It then replaces the data value at the center point with this average.

The window filtering process follows:

Note:

In the window filter equations:

- L = window length in scans
= 5 for FastCAT real-time data processing algorithm
- n = window index,
-([L-1] / 2) to +([L-1] / 2),
with 0 the center point of the window
- w(n) = set of window weights

1. Calculate cosine filter weights (see the equations below).

$$w(n) = 1 \quad \text{for } n = 0$$

$$w(n) = \cos \frac{n \times \pi}{L + 1} \quad \text{for } n = -\frac{L - 1}{2}, \dots, -1, 1, \dots, \frac{L - 1}{2}$$

2. Normalize filter weights to sum to 1.

Applying Conductivity Cell Thermal Mass Correction to Data

The FastCAT uses a recursive filter to remove conductivity cell thermal mass effects from the measured conductivity. Recommended values for alpha and tau (tau = 1 / beta) for the FastCAT are 0.03 and 7.0 respectively.

The algorithm, based on the Cell Thermal Mass module in SBE Data Processing, is:

$$a = 2 * \text{alpha} / (\text{sample interval} * \text{beta} + 2)$$

$$b = 1 - (2 * a / \text{alpha})$$

$$dc/dT = 0.1 * (1 + 0.006 * [\text{temperature} - 20])$$

$$dT = \text{temperature} - \text{previous temperature}$$

$$\text{ctm [S/m]} = -1.0 * b * \text{previous ctm} + a * (dc/dT) * dT$$

$$\text{corrected conductivity [S/m]} = c + \text{ctm}$$

Appendix VI: Replacement Parts

Part Number	Part	Application Description	Quantity in FastCAT
801385	4-pin RMG-4FS to 9-pin DB-9S I/O cable with power leads, 2.4 m (8 ft)	From FastCAT to computer/controller and power supply	1
17046.1	4-pin RMG-4FS dummy plug with locking sleeve	For storage when I/O cable not used	1
17043	Locking sleeve for RMG connector	Locks I/O cable or dummy plug in place	1
801206	4-pin MCIL-4FS (wet-pluggable connector) to 9-pin DB-9S I/O cable with power leads, 2.4 m (8 ft)	From FastCAT to computer/controller and power supply	1
171398.1	4-pin MCIL-4FS (wet-pluggable connector) dummy plug with locking sleeve	For storage when I/O cable not connected	1
171192	Locking sleeve (wet-pluggable connector)	Locks I/O cable or dummy plug in place	1
30411	Triton X-100	Octyl Phenol Ethoxylate – Reagent grade non-ionic cleaning solution for conductivity cell (supplied in 100% strength; dilute as directed)	1
801542	AF24173 Anti-Foulant Device	bis(tributyltin) oxide device inserted into anti-foulant device cup	1 (set of 2)
233564	Anti-foulant device cup on pump exhaust plumbing, black	Holds optional AF24173 Anti-Foulant Device	1
231565	Anti-foulant device cap on pump exhaust plumbing, black	Secures optional AF24173 Anti-Foulant Device in cup	1
233493	T-C Duct top, black	T-C Duct, also secures optional AF24173 Anti-Foulant Device in base	1
233515	T-C Duct base, black	T-C Duct, holds optional AF24173 Anti-Foulant Device	1
232395	Straight pump exhaust	Straight exhaust fitting, mounts to sensor guard	1
231408	Tee pump exhaust	Tee exhaust fitting for slow profiling applications, mounts to sensor guard	
30132	Screw, 4-40 x 3/4 flat Phillips-head, stainless	Secures pump exhaust fitting to sensor guard	1
30239	Washer, #4 nylon WN-4	For 30132 screw, placed between tee and sensor guard	2
31629	Tygon tubing, 3/8" ID x 5/8" OD, black	Exhaust plumbing	

Continued on next page

Continued from previous page

Part Number	Part	Application Description	Quantity in FastCAT
60037	Spare parts kit for SBE 49 in titanium housing	Assorted o-rings and hardware, including: <ul style="list-style-type: none"> • 231408 Exhaust tee (for slow profiling applications) • 30132 Machine screw, 4-40 x ¾ FH SS (secure exhaust tee to sensor guard) • 31081 Machine screw, 4-40 x ½ SHSS (retaining rod screw) • 30389 Cable tie, 4 inch (secure tubing to exhaust tee) • 30857 Parker, 2-033E515-70 (o-rings for both end caps) • 30859 Machine Screw, 8-32 x 3/8" FH Ti (secure end caps to housing) • 30947 Machine Screw, 2-56 x ½ FH SS (secure AF24173 anti-foulant device chamber top on sensor head) • 30992 Machine Screw, 2-56 x 5/8 PH Phillip SS (secure T-C Duct top to base) • 31076 O-ring, Parker 2-003 E515-80 (for 30992 screws) • 31182 O-ring, NAS1611-021 Ethylene Propylene (T-C Duct base to top o-ring seal) 	-
60052	Spare parts kit for SBE 49 in plastic housing	Assorted o-rings and hardware, including: <ul style="list-style-type: none"> • 231408 Exhaust tee (for slow profiling applications) • 30132 Machine screw, 4-40 x ¾ FH SS (secure exhaust tee to sensor guard) • 31081 Machine screw, 4-40 x ½ SHSS (retaining rod screw) • 30389 Cable tie, 4 inch (secure tubing to exhaust tee) • 30857 Parker, 2-033E515-70 (o-rings for both end caps) • 30947 Machine Screw, 2-56 x ½ FH SS (secure AF24173 anti-foulant device chamber top on sensor head) • 30992 Machine Screw, 2-56 x 5/8 PH Phillip SS (secure T-C Duct top to base) • 31076 O-ring, Parker 2-003 E515-80 (for 30992 screws) • 31182 O-ring, NAS1611-021 Ethylene Propylene (T-C Duct base to top o-ring seal) • 31516 Hex Key, 9/64" Long Arm, DoALL AHT58010 (for servicing cap screw) • 31755 Cap Screw, 8-32 X 1/4" SH, Titanium (secure end caps to housing) 	-

Continued on next page

Continued from previous page

50312	Anti-foulant device in-line cap/cup assembly	Assorted parts, including: <ul style="list-style-type: none"> • 233564 In-line Anti-Foulant black cup (for AF24173 Anti-Foulant Device) • 233565 In-line Anti-Foulant black cap (seals AF24173 Anti-Foulant Device in cup) • 30072 O-ring, 2-017 N674-70 (seal between cap and cup) • 31629 Black Tubing, 3/8" ID x 5/8" OD (plumbing) • 30389 Cable Tie, 4", Richco (secures plumbing to cap, cup, and CTD barbs) 	-
-------	--	---	---

Appendix VI: Manual Revision History

Manual Version	Date	Description
002	10/01	<ul style="list-style-type: none"> Initial release production units.
003	12/02	<ul style="list-style-type: none"> Add information on pressure output format in decibars. OutputFormat=2&3: Add information that leading 0's suppressed. Correct OutputFormat=2 description: temperature ttttt (not ttttttt), strain pressure pppppp (not pppppppp), strain T compensation v.vvvv (not vv.vvvv). Correct pressure sensor calibration fitting, add pressure sensor maintenance information. Anti-foul replacement: use EPA-approved description. Add information on baud rate and sampling time and cable length. Add more information pump operation details.
004	01/03	<ul style="list-style-type: none"> Add AF label pages in appendix.
005	01/03	<ul style="list-style-type: none"> Add information on mechanical design change of TC duct/anti-foul cup and cap.
006	03/03	<ul style="list-style-type: none"> Add compatibility with Seasave.
007	08/03	<ul style="list-style-type: none"> Update description of output format required for data to be processed by SBE Data Processing. Update to allow use of SBE 36 & PDIM with SBE 49. Add information on TC duct. Update for 9 pin computer connections. Correct Baud=: 600 baud is not valid with SBE 49.
008	07/04	<ul style="list-style-type: none"> Firmware 1.2: <ul style="list-style-type: none"> -- Add commands to align, filter, and apply thermal mass correction in real-time so computed salinity and sound velocity are correct. -- Remove PType=. -- Add SetDefaults. Remove optional 12-28 VDC range from specifications. Add plastic housing option. Update power specifications and power and cable length information. Update Seaterm screens to correspond to Seaterm versions 1.40 and later. Correct conductivity sensor calibration range to 2.6 – 6 S/m plus zero conductivity.
009	08/05	<ul style="list-style-type: none"> Update exhaust information: straight exhaust standard, tee exhaust in spares kit that ships with 49. Add 600 m pressure sensor to list of available sensor ranges. Update conductivity cell cleaning procedure to be consistent with application note 2D. Add more info about triton. Add information that pump does not run automatically for testing commands (TC, etc.). Update connector to MCBH with water block. Update AF24173 Anti-Foulant Device appendix to current label.
010	07/06	<ul style="list-style-type: none"> Change specification for plastic housing to 250 m from 350 m. Update Triton website link. Update pressure port maintenance, Sea-Bird no longer filling with silicon oil. Add information that can use SBE 49 with SBE 32 Carousel (with serial interface) and SBE 33 Deck Unit. Update recovery warning, providing more detail. Correct information on real-time data corrections.
011	05/07	<ul style="list-style-type: none"> Incorporate Seasave V7. Update .con file screen capture to show 'scan time added' field in SBE Data Processing and Seasave. Add information that can use SBE 49 with SBE 55 ECO Water Sampler and SBE 33 Deck Unit Add more information on deployment recommendations.

Continued on next page

Continued from previous page

012	08/08	<ul style="list-style-type: none"> • Manufacturing change: note in electronics disassembly/reassembly that for plastic housing, 2 phillips-head screws at connector end cap end & 3 at sensor end cap end replaced with hex screws. 9/64" allen wrench shipped with 49. • Change pressure stability specifications to per year instead of per month. • Update connector maintenance to be consistent with application note 57. • Add information that POffset is in decibars. • Update system schematics with 55, 32, 36 to show 19plus V2 CTD.
013	02/10	<ul style="list-style-type: none"> • Update anti-foul label in Appendix with new Container Handling requirement and new address. • Add information required for CE certification. • Add CE mark. • Update for Seasave/SBE Data Processing 7.19, configuration file now allows selection of NMEA connected directly to the computer. • Update software name. • Add statement about compatibility with Vista. • Seasave and SBE Data Processing 7.20a: Add information about .xmlcon file. • Update SBE address.
014	01/13	<ul style="list-style-type: none"> • Add Declaration of Conformity. • Update diagrams showing use with SBE 33 or 36 Deck Units, to include SBE 25plus in list of CTDs and to show Surface PAR channel as standard in these deck units. • Add note in dimensions section that exhaust barb is not flush to the housing. • Add more troubleshooting information. • Add photo showing removal of protective plugs before deployment. • Update software compatibility information. • Remove references to Druck pressure sensors (can be supplied by other manufacturers). • Add information about cell thermal mass corrections in freshwater deployments. • Add cable and internal wiring diagrams. • Update description of PN 50312. • Add PN 60052 spare parts kit. • Update Triton company name and link.
015	09/13	<ul style="list-style-type: none"> • Change specification for plastic housing to 350 m from 250 m. • Clarify that accuracy specifications are \pm. • Add information on editing raw .hex files. • Update Declaration of Conformity. • Add section on O-ring maintenance. • Remove reference to old version of Seasave (Seasave-Win32). • Correct part numbers in <i>Replacement Parts</i> for T-C duct, anti-foulant holder, and plumbing.
016	03/14	<ul style="list-style-type: none"> • Remove information that Seasave does not allow Surface PAR acquisition with SBE 49; update Seasave configuration dialog box for software update to accommodate Surface PAR (Seasave 7.23.2). • Add caution on using spray can lubricants on MCBH connectors. • Remove <i>standard</i> and <i>optional</i> language.

Index

.con file · 41
 .hex files
 editing · 46
 .xmlcon file · 41

A

Anti-Foulant Devices · 62
 replacing · 50, 51
 Autonomous sampling · 22
 Autonomous sampling commands · 30
 AUV · 44

B

Baud rate · 25, 42

C

Cable length · 25, 26
 Cables · 13
 Calibration · 53
 Calibration coefficient commands · 33
 CE certification · 3
 Circuitry · 58
 Cleaning · 48
 Command summary · 60
 Commands
 autonomous sampling · 30
 calibration coefficients · 33
 descriptions · 27
 polled sampling · 32
 setup · 29
 status · 28
 testing · 32
 Communication defaults · 18
 Configuration file · 41
 Connector · 12, 47
 Corrections
 real-time · 24, 66
 Corrosion precautions · 47

D

Data corrections
 real-time · 24, 66
 Data I/O · 14
 Data output format · 34
 Data processing · 43, 44
 real-time · 24, 66
 Data transmission rate · 25
 Declaration of Conformity · 3
 Deployment
 installation · 40
 optimizing data quality · 36
 setup · 39
 Description · 8
 Dimensions · 12

E

Editing data files · 46
 Electronics disassembly/reassembly · 59
 End cap · 12, 47
 Exhaust · 12, 37

F

Format
 data output · 34
 Functional description · 58

G

Glossary · 57

M

Maintenance · 47
 Manual revision history · 72
 Modes · *See* Sampling modes

O

O-ring
 maintenance · 48

P

Parker Super O-Lube · 57
 Parts
 replacement · 69
 Plastic housing
 handling · 49
 Polled sampling · 21
 Polled sampling commands · 32
 Power · 26
 Pressure sensor
 maintenance · 48
 Processing data · 43, 44

Q

Quick start · 6

R

Real-time corrections · 24, 66
 Real-time data acquisition · 41, 44
 Real-time processing · 24, 66
 Recovery
 physical handling · 45
 Replacement parts · 69
 Revision history · 72
 ROV · 44

S

Sampling
 autonomous · 22
 polled · 21
Sampling commands · 30, 32
Sampling modes · 20
Saterm
 main screen · 16
SBE Data Processing · 10, 15, 43, 44
Seasave · 10, 15, 41
Seasoft · 10, 15
Seaterm · 10, 15, 16
 toolbar buttons · 17
Sensors · 11
Setup commands · 29
Software · 10
 installation · 15
Specifications · 11
Status command · 28
Storage · 48
Straight exhaust · 12, 37
Super O-Lube · 57
System description · 8

T

Tee exhaust · 12, 37
Test
 power and communications · 15
 setup · 15
Testing commands · 32
Triton · 57

U

Unpacking FastCAT · 7

V

Versions · 72

W

Wiring · 13