



APPLICATION NOTE NO. 15

September 2003

TC Duct Assembly and Plumbing Installation

This Application Note describes use of the PN 90085 Customer-Installed TC Duct Kit, covering:

- Installation and removal of the TC (Temperature-Conductivity) Duct Assembly on the SBE 3 temperature sensor and SBE 4 conductivity sensor on an SBE 9 / 9plus or SBE 25 SEALOGGER CTD, when equipped with the standard sensor mounting bracket.
- Installation of system plumbing for the CTD with a pump and (optional) SBE 13 or SBE 23 Dissolved Oxygen (DO) Sensor. Sea-Bird stopped selling the SBE 13 and 23 in early 2001, and began selling the SBE 43 DO Sensor. The orientation / location of the SBE 43 differs from what is shown in this application note, although the same parts are used for the plumbing; **see Application Note 64-1 for plumbing installation for a system including the SBE 43.**

Both the installation and removal procedures require slow, deliberate movements to avoid breaking the temperature or conductivity sensor. Therefore, Sea-Bird recommends that you perform these procedures in a lab, not on deck.

Note:

If your conductivity sensor does not have a conductivity tube support, install the conductivity tube support kit (see Application Note 36) before installing the TC Duct and plumbing.

Conductivity tube support kit:
 PN 50094 for aluminum sensors
 PN 50108 for titanium sensors

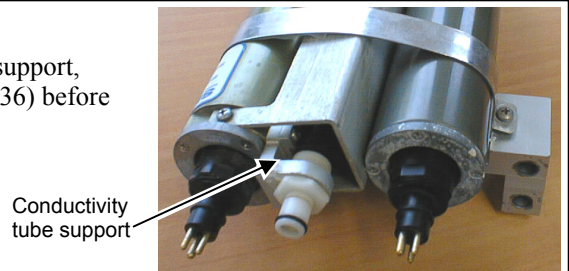

TC Duct Installation

Preparation

Parts Included in PN 90085 Kit that are Used for TC Duct Installation

- Temperature sensor guard assembly (replaces existing temperature sensor guard), which consists of:
 - Temperature sensor guard
 - T Duct
 - Morrison seal 0.026 ID x 0.24 OD, installed in T Duct
 - (2) Phillips-head nylon machine screws, 2-56 x 1/4, attaching T Duct to temperature sensor guard

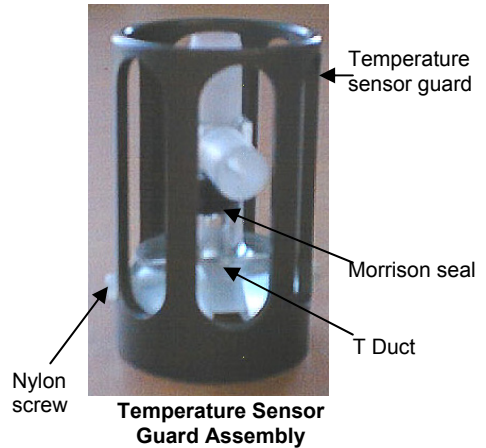

- C Duct assembly (fits into end of conductivity cell), which consists of:
 - C Duct
 - Flexible plastic (Tygon) tubing – 3 pieces:

	Inner Diameter (ID)	Wall Thickness	Approximate Length	Function
a	6.35 mm (0.25 in.)	0.76 mm (0.03 in.)	13 mm (0.5 in.)	Connect C Duct to T Duct
b	6.35 mm (0.25 in.)	3.18 mm (0.125 in.)	10 mm (0.375 in.)	Installed under tubing 'c' to provide seal at conductivity sensor
c	11.11 mm (0.4375 in.)	1.59 mm (0.0625 in.)	25 mm (1.0 in.)	Installed over tubing 'b' to provide seal at conductivity sensor

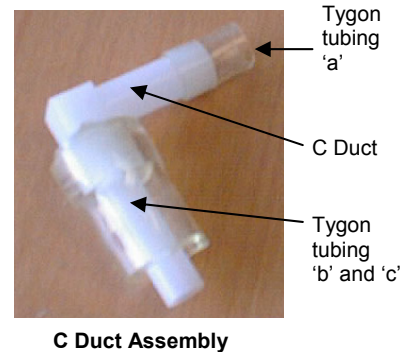

Tools Required

Straight-edge ruler for measuring

For cutting C Duct horizontal arm (older CTDs, if necessary):

- Fine-toothed (2 teeth per mm [50 teeth per in.] or finer) backsaw
- 10 degree (approximate) tapering tool – a sharp pencil is acceptable
- 400 grit (very fine) sandpaper

Installation

Before beginning, place the CTD cage in a horizontal position, so the conductivity and temperature sensors are on top. For clarity, the sensors and mounting bracket are shown removed from the CTD cage in the photos below – however, you do not need to remove the sensors and mounting bracket from the CTD cage to install the TC Duct.

T Duct Installation

1. Remove the temperature sensor from the sensor mounting bracket:
 - A. Unscrew the locking sleeve from the temperature sensor's cable connector by hand. **If you must use a wrench or pliers, be careful not to loosen the bulkhead connector instead of the locking sleeve.**
 - B. Remove the cable connector from the temperature sensor by pulling the connector firmly away from the temperature sensor. **Do not pull on the cable.**
 - C. Loosen the mounting strap that secures the temperature and conductivity sensors in the sensor mounting bracket.
 - D. Slide the temperature sensor out of the mounting bracket.

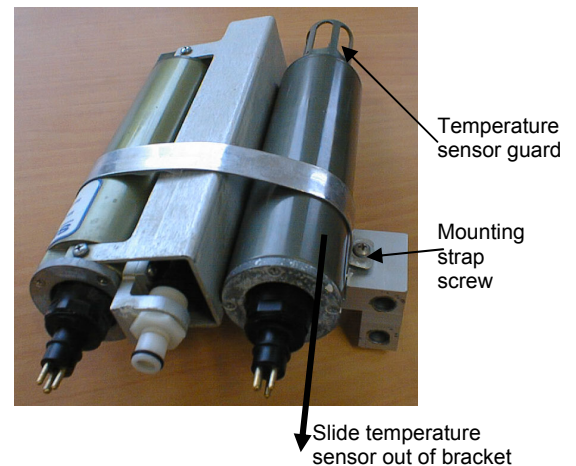

2. Unscrew the existing temperature sensor guard, **being careful not to damage the temperature sensor needle.**

3. Install the new temperature sensor guard assembly on the temperature sensor:
 - A. Looking through the T Duct's sight hole to center the temperature sensor needle, slowly and carefully insert the temperature sensor needle into the base of the T Duct. **Do not bend or torque the needle.** You will feel a little resistance as the needle goes through the black Morrison seal in the T Duct.
 - B. Screw the guard on tightly (hand-tighten only).

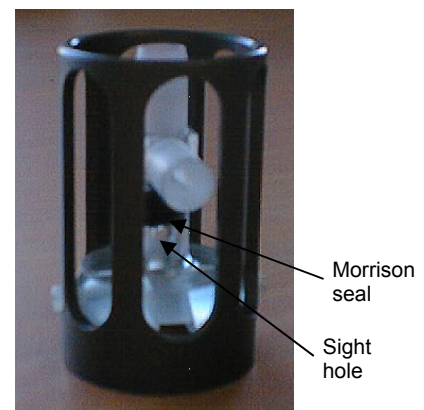

4. Reinstall the temperature sensor in the mounting bracket:
 - A. Slide the temperature sensor into the sensor mounting bracket until the end of the temperature sensor guard extends beyond the conductivity sensor guard approximately 29 mm (1 1/8 in.).
 - B. Retighten the mounting strap enough to hold the sensors in position, but loose enough to allow the temperature sensor to slide and rotate in the mounting bracket.

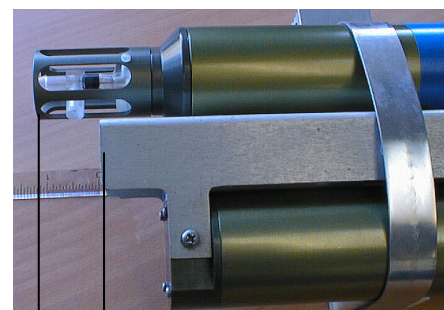

C Duct Installation and Fit Check

1. Remove the 13 mm (0.5 in.) piece of Tygon tubing 'a' from the large end of the C Duct.
2. Insert the small end of the C Duct straight into the glass conductivity cell's intake until the Duct's shoulder butts against the end of the cell.

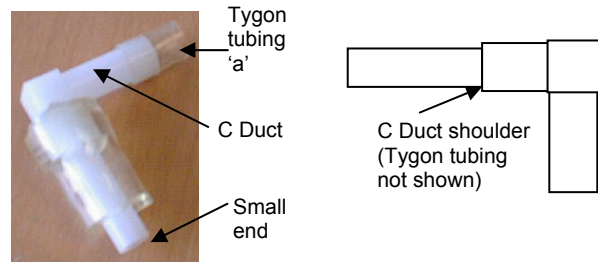

3. Carefully rotate the C Duct's arm toward the temperature sensor.
4. Slide and rotate the temperature sensor until the T and C Duct arms are perfectly aligned, leaving a gap of 1.25 to 2.5 mm (0.05 to 0.10 in.) between the ends of the Ducts.
 - If the Duct arms overlap (possible on some older systems), the C Duct must be trimmed. Proceed to *C Duct Trimming*.

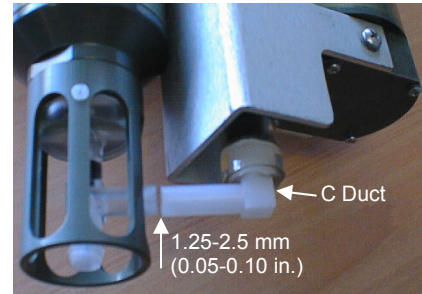

5. Gradually tighten the sensor mounting bracket strap's screw. Check for changes in alignment and changes in the gap between the Duct ends. As the sensors are secured into the bracket, the T and C Ducts usually move closer together, reducing or eliminating the gap between the arms. **Do not continue to tighten the strap after the gap has been eliminated, as doing so will break the conductivity cell.**
 - If the Duct arms are touching and either of the sensors is not secure in the mounting bracket, the C Duct must be trimmed. Proceed to *C Duct Trimming*.

When the sensors are securely tightened and there is still a small gap of 0.5 to 1.25 mm (0.02 to 0.05 in.) between the ducts, proper fit is verified. Proceed to *Final Assembly*.

Final Assembly

1. Rotate the temperature sensor guard counter-clockwise approximately 90 degrees, so the T Duct is out of the way.
2. Remove the C Duct and reinstall Tygon tubing 'a':
 - A. Carefully rotate the C Duct clockwise slightly, and gently pull the C Duct straight out from the conductivity cell.
 - B. Reinstall Tygon tubing 'a' over the end of the C Duct. Leave approximately half of the tubing hanging past the end of the C Duct.
 - C. Reinstall the C Duct on the conductivity cell, leaving it in the *rotated* position described in Step A.
3. Slowly rotate the temperature sensor guard back into position. As you rotate, insert the end of the T Duct into Tygon tubing 'a'. Continue to rotate both the sensor guard and C Duct until the T and C Ducts are aligned. **Do not apply force perpendicular to the end of the cell, as doing so will break the cell.**
4. Center Tygon tubing 'a' on the joint between the C Duct and T Duct.
5. Reinstall the cable connector and locking sleeve on each sensor:
 - A. Lightly lubricate the inside of the cable connector with silicone grease (DC-4 or equivalent). **Do not use WD-40 or other petroleum-based lubricants, as they will damage the connectors.**
 - B. Install the cable connector, aligning the raised bump on the side of the connector with the large pin (pin 1 – ground) on the bulkhead connector. Remove any trapped air by *burping* or gently squeezing the connector near the top and moving your fingers toward the end cap.
 - C. Place the locking sleeve over the cable connector. Tighten the locking sleeve finger tight only. **Do not overtighten the locking sleeve and do not use a wrench or pliers.**

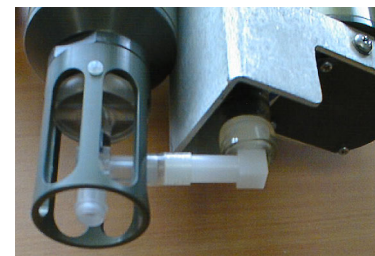
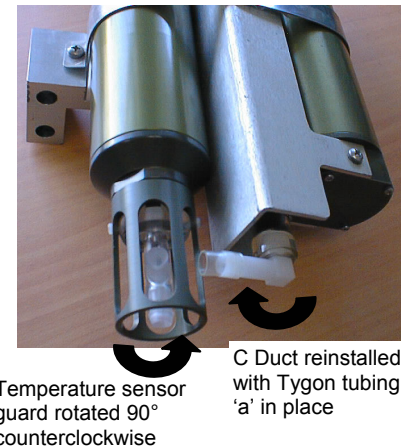

C Duct Trimming (if necessary, as described in Steps 4 and 5 of C Duct Installation and Fit Check)

Some older systems have a different sensor mounting bracket, causing the duct arms to overlap. For these systems, the C Duct arm must be trimmed.

1. Determine the correct length of the C Duct arm:
 - A. Rotate and/or slide the temperature sensor until the center lines of the duct arms are parallel.
 - B. Mark the end of the C Duct for trimming, allowing for a gap of 1.25 to 2.5 mm (0.05 to 0.10 in.) between the T and C Ducts.

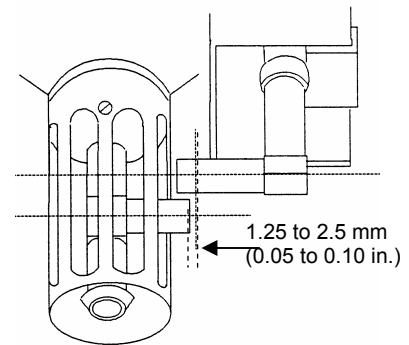

2. Trim the C Duct arm and check for fit:
 - A. Carefully rotate the C Duct clockwise slightly, and gently pull the C Duct straight out from the conductivity cell.
 - B. Trim off the end of the C Duct arm with a fine-toothed backsaw, **being careful not to crush the thin-walled Duct while cutting.**
 - C. Clean the C Duct with water to remove dust and grit.
 - D. Reinsert the C Duct in the conductivity cell.
 - E. Rotate and/or slide the temperature sensor until the center lines of the horizontal duct arms are parallel, and verify that the gap between the arms is 1.25 to 2.5 mm (0.05 to 0.10 in.). If not, mark the end of the C Duct arm for trimming and repeat Step 2.

3. Prepare the edges of the C Duct for final installation:
 - A. Carefully rotate the C Duct clockwise slightly, and gently pull the C Duct straight out from the conductivity cell.
 - B. Sand or file the cut square and flat. Remove any burrs.
 - C. Chamfer the inside edge of the trimmed end at a 10 degree angle, leaving approximately half the wall thickness between the end of the taper and the outside of the duct wall. A sharpened pencil, wrapped with 400 grit sandpaper, makes a good chamfering tool.
 - D. Clean the C Duct with water to remove dust and grit.

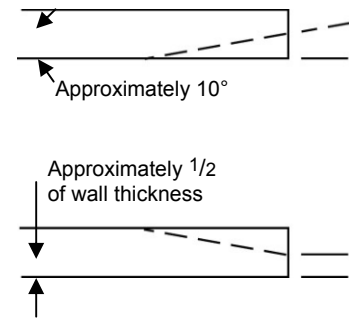

4. Return to *C Duct Installation and Fit Check* at Step 2.

C Duct and Sensor Removal

For sensor shipment and calibration, the C Duct must be disconnected from the T Duct and removed from the conductivity cell. Note that the temperature sensor should be shipped with the temperature sensor guard, which includes the installed T Duct.

1. Remove the conductivity and temperature sensors and mounting bracket assembly from the CTD:
 - A. Unscrew the locking sleeves from the temperature and conductivity sensor cable connectors by hand.
If you must use a wrench or pliers, be careful not to loosen the bulkhead connector instead of the locking sleeve.
 - B. Remove the cable connector from each sensor by pulling the connector firmly away from the sensor.
 - C. Remove the quick-release plug from the conductivity cell.
 - D. Remove the two $\frac{9}{16}$ inch hex head aluminum bolts that secure the mounting bracket to the CTD's end cap. Remove the mounting bracket from the CTD.

2. Disconnect the T Duct from the C Duct:
 - A. Slowly rotate the temperature sensor guard by turning it counterclockwise approximately 90 degrees. At the same time, rotate the C Duct clockwise slightly. The Tygon tube that joins the ducts flexes and slips off the T Duct as the T Duct twists out of its position.

Note: Do not force the C Duct, as this could break the conductivity cell. If rotating the C Duct is difficult, pour water over the duct area to dissolve buildup around the duct.

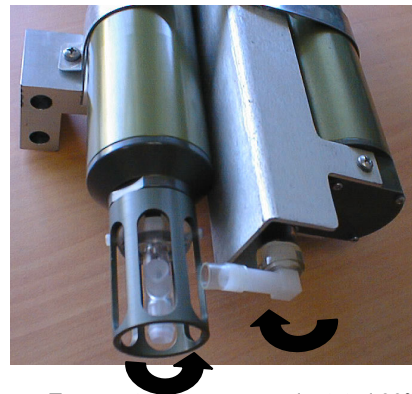

Temperature sensor guard rotated 90° counterclockwise while C Duct rotated clockwise slightly

3. Remove the C Duct from the conductivity cell:
 - A. Carefully rotate the C Duct clockwise more. **Do not force the C Duct**, as this could break the conductivity cell. If rotating the C Duct is difficult, pour water over the duct area to dissolve buildup around the duct.
 - B. Once loosened, gently pull the C Duct straight out from the conductivity cell.
 - C. Store the C Duct for reinstallation when the sensors have returned from calibration.



4. Retighten the temperature sensor guard by hand.
5. Loosen the mounting bracket strap screw, and slide the sensor(s) from the bracket. If both sensors are being shipped, SBE *9plus* sensors can be shipped in their mounting bracket.
6. The conductivity cell is stored and shipped dry, to prevent damage caused by freezing:
 - A. Rinse the conductivity cell with clean, de-ionized water.
 - B. Drain and gently blow-dry the conductivity cell. **Do not use compressed air, which typically contains oil vapor.**
7. Ship the sensor(s) in a package with cushioning material to protect them from damage during shipment.



Plumbing Installation

Application

The remainder of this application note describes plumbing installation for a CTD with a pump and (optional) SBE 13 or SBE 23 Dissolved Oxygen (DO) Sensor. Sea-Bird stopped selling the SBE 13 and 23 in early 2001, and began selling the SBE 43 DO Sensor. The orientation / location of the SBE 43 differs from what is shown in this application note, although the same parts are used for the plumbing; **see Application Note 64-1 for plumbing installation for a system including the SBE 43.**

Preparation

Parts Included in PN 90085 Kit that are Used for Plumbing Installation

PN	Description	Quantity
23337	Pump air release valve - for vertical configuration only	1
30387	Tube, 1/2" Y-fitting - for connection to pump air release valve, vertical configuration only	1
30388	Tygon tubing, 19 mm (0.75 in.) OD, 13 mm (0.5 in.) ID	4 ft
30579	Tygon tubing, 13 mm (0.5 in.) OD, 9.5 mm (0.375 in.) ID - for connections to DO sensor	0.5 ft
30389	Cable tie, 102 mm (4 in.) - to secure tubing connections	20
30458	Cable tie, 381 mm (15 in.) - to secure Y-fitting to main housing	2

Tools Required

Sharp knife or scalpel for cutting tubing
Straight-edge ruler for measuring and cutting

Installation

For plumbing installation:

- Use the minimum tubing lengths necessary, but avoid tight bends in the tubing. Tight bends place stress on the tubing connections at the sensors, which can lead to failures at the connections.
- Do not create any vertical loops in the tubing. Loops trap air, preventing the pump from working properly.
- Secure each tubing connection with two cable ties.

Plumbing installation details differ, depending on whether the sensors will be deployed in a vertical or horizontal configuration. See *Vertical Configuration Schematic and Details* and *Horizontal Configuration Schematic and Details* below.

Vertical Configuration Schematic and Details

When installing plumbing for the vertical configuration:

- (For SBE 9plus only) Place the intake and exhaust on the same horizontal plane. Attach exhaust tubing from the pump to the cage, as shown in the schematic below. Failure to place the exhaust tubing properly can lead to acceleration of water in the plumbing, with resulting errors in conductivity data.
Note: Exhaust tubing is usually omitted by Sea-Bird for an SBE 25.
- Place the exhaust away from the intake, so the exhaust water is not pulled into the intake. In the top left photo on the next page, the exhaust and intake are in diagonally opposing corners. If the exhaust is too close to the intake, it will cause errors in the temperature data, because the pump transfers heat to the exhaust water.
- Place a 25 mm (1 in.) long piece of 9.5 mm (0.375 in.) ID Tygon tubing at the DO sensor intake and exhaust. Slide the larger diameter Tygon tubing (13 mm ID) over the smaller diameter tubing to provide tight seals.
- If the system does not include a DO sensor, connect the tubing from the conductivity cell directly to the Y-fitting.

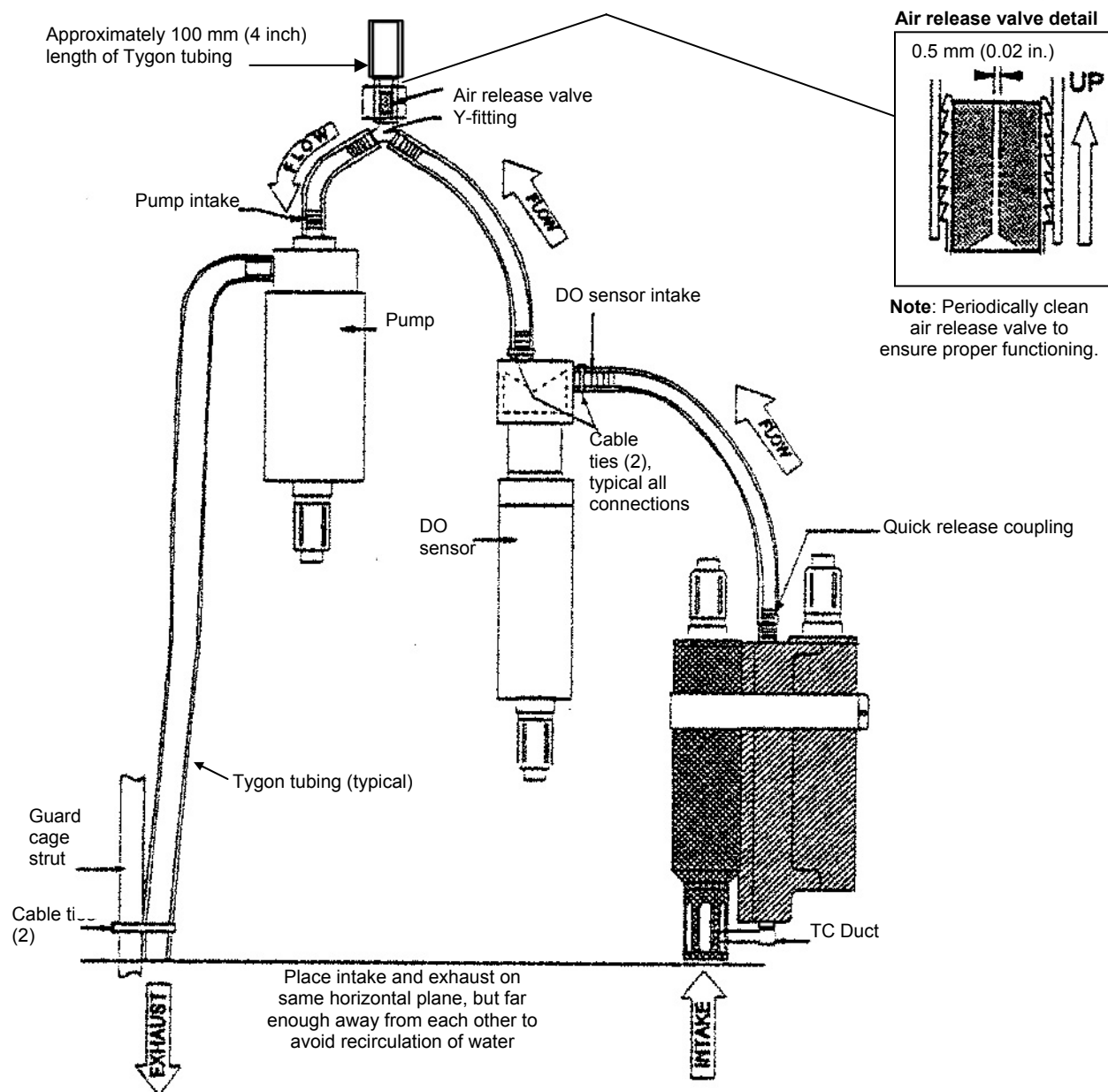

Vertical Configuration Schematic and Details (continued)

All photos are of an SBE 9plus. Secure each tubing connection with two cable ties (not shown).

**Overall View –
Temperature/Conductivity Sensor Side**



TC Duct intake – same horizontal plane as exhaust
DO sensor

**Overall View –
Pump Side**



See Y fitting Detail below
Pump
Note: Exhaust tubing is usually omitted by Sea-Bird for an SBE 25.
DO sensor
Exhaust tubing – same horizontal plane as TC Duct intake. Attach to guard cage strut with cable ties.

**Temperature/Conductivity to
DO Sensor Detail**



Slide larger diameter Tygon tubing over smaller diameter Tygon tubing to provide tight seal at DO sensor
Tygon tubing
Quick release coupling on conductivity cell

Y Fitting Detail



100 mm (4 in.) length of Tygon tubing
Cable tie
Y fitting with air release valve
Tygon tubing

Horizontal Configuration Schematic and Details

The horizontal configuration is most commonly used when the CTD is integrated with an SBE 32 Carousel Water Sampler with an extension stand. When installing plumbing for the horizontal configuration:

- Configure the system as follows:
 - Place the DO sensor intake above the conductivity sensor exhaust.
 - Place the pump intake above the DO sensor exhaust.
 - Orient the pump with the exhaust outlet *corner* up.

Failure to configure the system in this manner can trap air, preventing the pump from working properly.

- Place a 25 mm (1 in.) long piece of 9.5 mm (0.375 in.) ID Tygon tubing at the DO sensor intake and exhaust. Slide the larger diameter Tygon tubing (13 mm ID) over the smaller diameter tubing to provide tight seals.
- If the system does not include a DO sensor, connect the tubing from the conductivity cell directly to the pump intake.

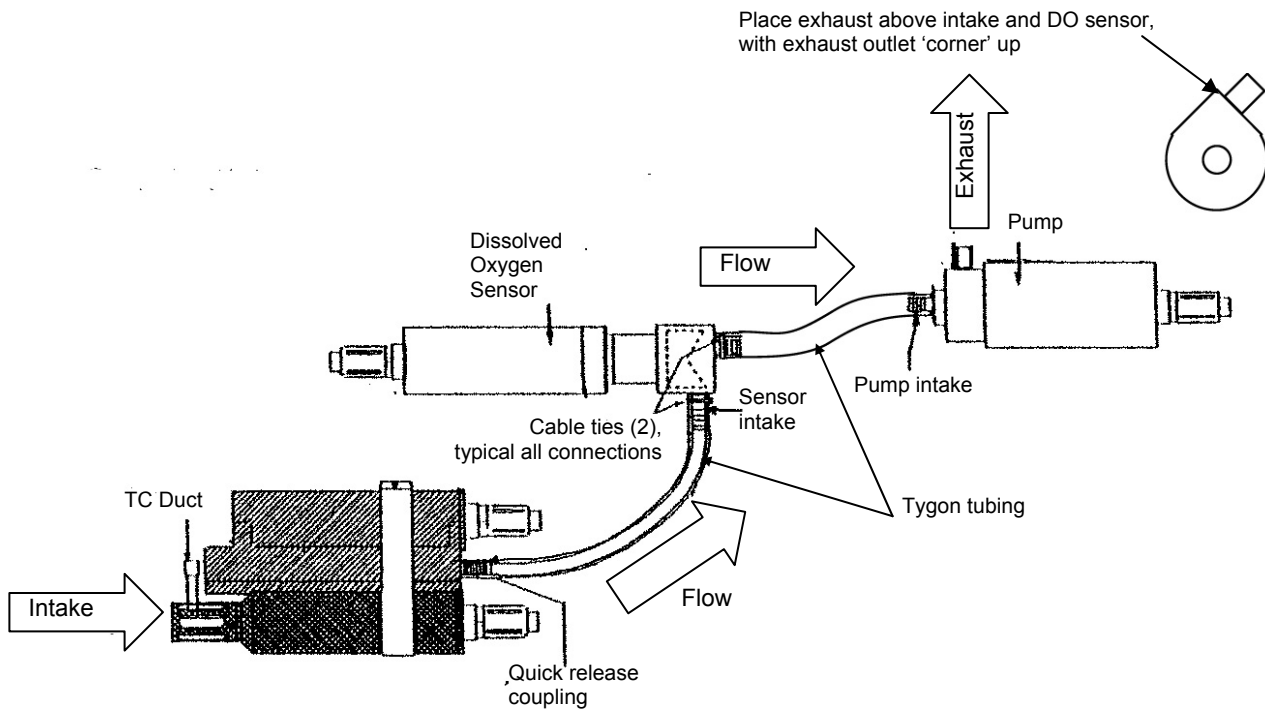

Horizontal Configuration Schematic and Details (continued)

All photos are of an SBE 9plus. Secure each tubing connection with two cable ties (not shown).

Overall View

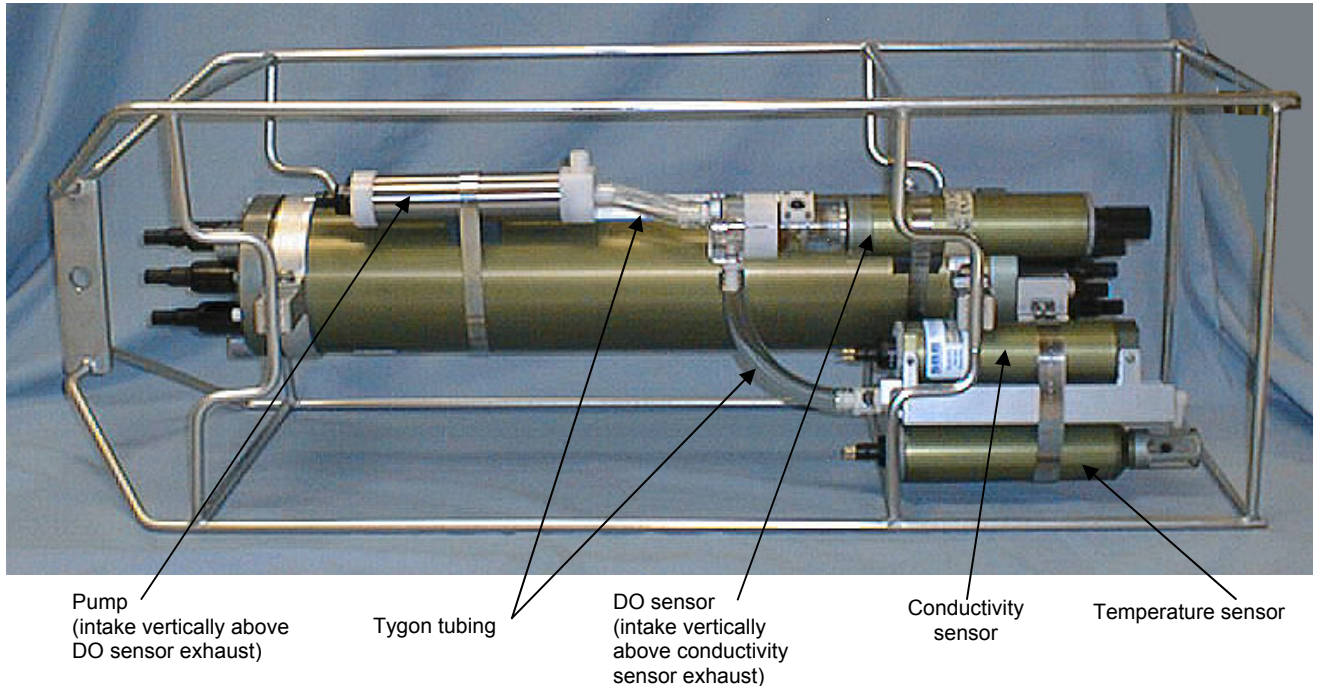

Connection Details

