

Underwater Inductive Modem

SBE 44



The SBE 44 Underwater Inductive Modem (UIM) makes it possible to integrate current meters, Doppler profilers, or other instruments having standard serial interfaces with MicroCATs or other instruments that communicate via Sea-Bird's inductive modem telemetry system. The UIM has a built-in inductive cable coupler (split toroid) and cable clamp, providing data communications without the need for electrical connections, and an easy and secure attachment to any point on a jacketed mooring wire. An underwater bulkhead connector on the end cap provides the serial data connection, a control line, and switched power out.

The Inductive Modem (IM) system provides reliable, low-cost, real-time data transmission for up to 100 IM instruments, using a single, plastic-coated steel mooring cable. IM instruments clamp anywhere along the inherently rugged mooring cable; expensive and potentially unreliable multi-conductor cables are not required. Because data can be telemetered from instruments located anywhere along the mooring cable, IM systems are far more efficient and flexible than acoustic modems, which place serious demands on battery capacity and can return data from a single underwater position only.

INDUCTIVE MODEM SYSTEM OVERVIEW

When using the UIM, all that is required to link a computer or data logger to a serial instrument is a Surface Inductive Modem (SIM) PCB and a jacketed mooring wire. Communication between the PC or data logger and the SIM is full-duplex RS-232C (RS-485 optional). Commands and data are transmitted half-duplex between the SIM and the UIM. The UIM interprets the commands, relays correctly addressed commands to the serial instrument, and transmits replies from the instrument to the SIM. There are two methods of connecting the SIM to the jacketed wire:

- In a direct connection (typical cable to shore applications), the bottom end of the wire is grounded to seawater, and the top end remains insulated all the way to the connection to the SIM. A second wire from the SIM connects to seawater ground, completing the circuit.
- In typical surface buoys it is often preferable to connect the jacketed mooring wire to the buoy with a length of chain, grounding the jacketed wire to seawater at each end. An inductive cable coupler (ICC) connects the SIM to the jacketed wire above the uppermost UIM and below the point where the wire is grounded.

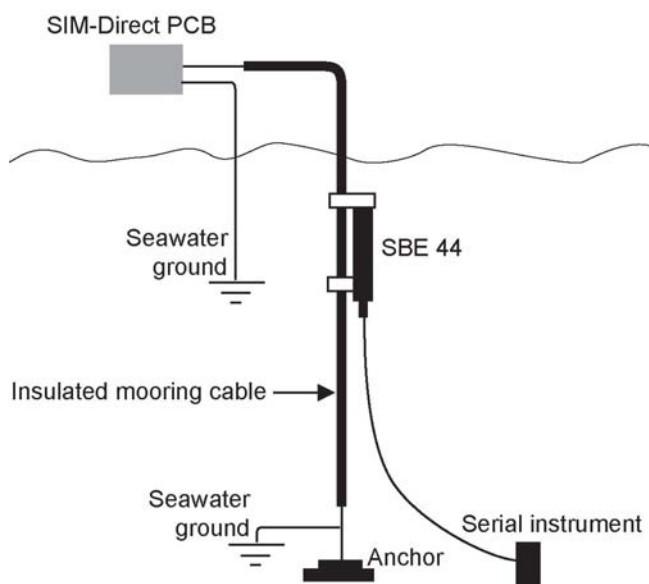

Direct Connection

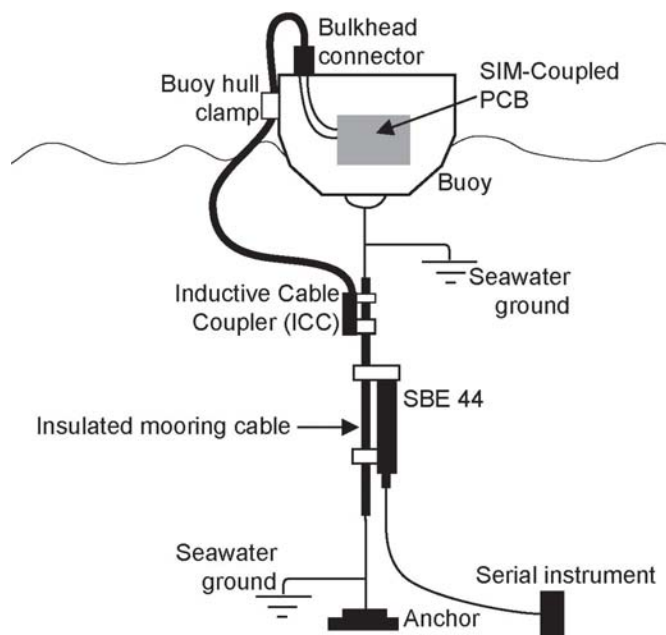

Connection with ICC

DPSK (Differential Phase Shift Keyed) DATA TRANSMISSION

Sea-Bird's Inductive Modem telemetry system uses a DPSK data transmission method that overcomes most of the disadvantages of Frequency Shift Keyed (FSK) transmission, resulting in superior transmission efficiency and much lower error rates. The Sea-Bird system uses a carrier frequency of 4800 Hz, permitting four cycles of carrier frequency during the time allotted to each data bit (i.e., 1200 baud).

The encoding scheme is straightforward: if the next bit is a one, the phase of the carrier is inverted (shifted 180 degrees); if the next bit is a zero, the carrier phase does not change. With DPSK, both the modulation and demodulation hardware are extremely simple. Modulation requires only an OR gate and flip-flop, and demodulation is inherently coherent (bit energy is averaged rather than spot-sampled) using minimal hard logic, a shift register implementing a one-bit delay being the principle component. Further advantages are that the transmission of all zeros creates a single coherent frequency (4800 Hz) that is readily detected in inductive modem instruments as the *wake up* signal, and that - unlike FSK - the connection polarity of the transformers used for coupling does not matter.

OPERATION

The UIM transmits data over any insulated wire. Communication on a mooring is typically via the jacketed mooring wire. Full ocean-depth mooring cables can be used. The DPSK telemetry system provides a high degree of immunity from *fishbite* or other cable degradation. For laboratory bench testing, simply loop any insulated wire through the inductive toroid and connect the ends of the wire to the SIM board.

Each UIM has a programmable address, allowing up to 100 UIMs (or other instruments compatible with the Sea-Bird inductive modem) to be attached to a single mooring cable. Upon receipt of a global wakeup command, the SIM sends a tone for two seconds, waking all UIMs on the cable. When the UIM receives a command containing its unique ID, it relays the command to the serial instrument and then transmits the reply over the inductive link. A 30 Kbyte FIFO buffer allows the UIM to interface to serial instruments at 300, 600, 1200, 2400, 4800, 9600, or 19200 baud while transmitting data at 1200 baud over the inductive modem link. Programmable setup parameters stored in EEPROM include timeout values, control signal logic, and sensor response termination logic, allowing the UIM to interface to a wide variety of instruments without requiring custom programming. A global power-off command returns all UIMs to a quiescent (sleep) stand-by state. The UIM automatically returns to quiescent state if there is no line activity for a user-specified length of time.

The UIM can be externally powered, and can provide power to a serial instrument from the external source or its internal battery pack, via the bulkhead connector's *switched power output* pins. The UIM is powered by a 10.6 Amp-hour (nominal) battery pack consisting of twelve AA lithium batteries (Saft LS14500) which, when removed from the UIM, can be shipped via commercial aircraft. The internal battery is diode-OR'd with the external supply, so whichever voltage is higher will be available to power another instrument.

UIM SPECIFICATIONS

Sensor Interface: RS-232 standard; RS-485 optional
Power:

- Quiescent current: < 100 microAmps
- Operating current: 10 milliAmps
- Maximum current to serial instrument: 1.5 Amps

Power Supply: 10.6 Amp-hour (nominal) battery pack

Materials: Titanium housing

Depth Capability: 7000 meters (23,000 feet)

SIM AND ICC SPECIFICATIONS — Available separately

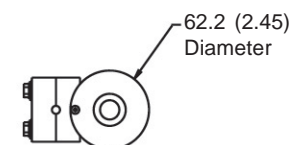
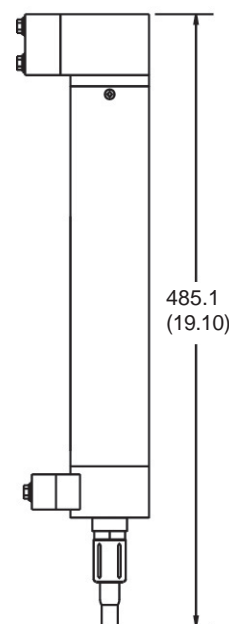
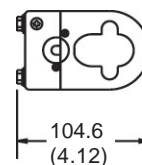

Dimensions in millimeters (inches)

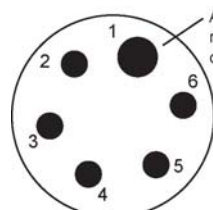

Standard Connector
AG-306-HP

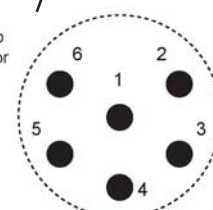

Optional Wet-Pluggable Connector
MCBH-6MP (WB), TI
(3/8" length base, 1/2-20 thread)

Pin	Description
1	Common
2	RS-232C Receive from serial instrument
3	RS-232C Transmit to serial instrument
4	Switched power out (optional)
5	Control signal (optional)
6	External power in (10-20 VDC) (optional)

Align with raised bump on connector



Sea-Bird Electronics, Inc.

13431 NE 20th Street, Bellevue, Washington 98005 USA

Website: <http://www.seabird.com>

E-mail: seabird@seabird.com

Telephone: (425) 643-9866

Fax: (425) 643-9954