

SBE 21 SEACAT Thermosalinograph

*Conductivity and Temperature Recorder
with RS-232 Interface*



Note:

New address (mid-January 2010;
check website for exact date)
13431 NE 20th Street
Bellevue, WA 98005 USA

User's Manual

Sea-Bird Electronics, Inc.
1808 136th Place NE
Bellevue, Washington 98005 USA
Telephone: 425-643-9866
Fax: 425-643-9954
E-mail: seabird@seabird.com
Website: www.seabird.com

Manual Version #026, 12/23/09
SBE 21 Firmware 5.0a and later
90488 Interface Box Firmware 3.1b and later
Seasave V7 Version 7.20a and later
SBE Data Processing Version 7.20a and later



Limited Liability Statement

Extreme care should be exercised when using or servicing this equipment. It should be used or serviced only by personnel with knowledge of and training in the use and maintenance of oceanographic electronic equipment.

SEA-BIRD ELECTRONICS, INC. disclaims all product liability risks arising from the use or servicing of this system. SEA-BIRD ELECTRONICS, INC. has no way of controlling the use of this equipment or of choosing the personnel to operate it, and therefore cannot take steps to comply with laws pertaining to product liability, including laws which impose a duty to warn the user of any dangers involved in operating this equipment. Therefore, acceptance of this system by the customer shall be conclusively deemed to include a covenant by the customer to defend, indemnify, and hold SEA-BIRD ELECTRONICS, INC. harmless from all product liability claims arising from the use or servicing of this system.

Table of Contents

Section 1: Introduction	5
About this Manual	5
Unpacking SBE 21.....	6
Section 2: Description of SBE 21	7
System Description	7
Specifications.....	9
Dimensions and Bulkhead Connectors	10
Data I/O	11
Data Storage.....	11
Remote Temperature Sensor (optional)	11
Section 3: Installing System	12
Installing Software.....	12
System Schematic and Installation Guidelines	13
Mechanical Installation.....	15
Electrical Installation	16
Section 4: Setting Up SBE 21	18
Setting Communications Parameters in Interface Box	18
Power and Communications Test and SBE 21 Setup in SEATERM.....	18
Command Descriptions.....	23
Checking SBE 21 Configuration (.xmlcon or .con) File in Seasave.....	38
Data Formats.....	40
Notes on SBE 38 Remote Temperature Data Format	41
Section 5: Setting Up NMEA Interface	42
NMEA Operating Modes.....	42
Setting Up and Testing NMEA.....	43
Troubleshooting NMEA Interface	45
Setting Up SBE 21 Configuration (.xmlcon or .con) File.....	45
Section 6: Operating System	46
Acquiring Real-Time Data with Seasave.....	46
Uploading SBE 21 Data from Memory	49
Processing Data.....	52
Editing Raw Data File	52
Section 7: Routine Maintenance and Calibration	54
Corrosion Precautions.....	54
Removing Sensor/Electronics Module from SBE 21 Water Jacket	54
Cleaning and Storage	55
Sensor Calibration.....	56
Section 8: Troubleshooting.....	57
Problem 1: Unable to Communicate with Interface Box	57
Problem 2: Unable to Communicate with SBE 21.....	57
Problem 3: No Data Recorded	58
Problem 4: Nonsense or Unreasonable Data.....	58
Problem 5: Salinity Lower than Expected	58
Problem 6: Program Corrupted.....	59

Glossary	60
Appendix I: Functional Description.....	61
Sensors	61
Sensor Interface	61
Real-Time Clock.....	61
Power	61
Appendix II: Electronics Disassembly/Reassembly	62
Appendix III: Command Summary	64
Appendix IV: AF24173 Anti-Foulant Device	66
Appendix V: Replacement Parts	70
Index.....	72

Section 1: Introduction

This section includes contact information and photos of a standard SBE 21 shipment.

About this Manual

This manual is to be used with the SBE 21 SEACAT Thermosalinograph Conductivity and Temperature Recorder. It is organized to guide the user from installation through operation and data collection. We have included detailed specifications, command descriptions, maintenance and calibration information, and helpful notes throughout the manual.

Sea-Bird welcomes suggestions for new features and enhancements of our products and/or documentation. Please contact us with any comments or suggestions (seabird@seabird.com or 425-643-9866). Our business hours are Monday through Friday, 0800 to 1700 Pacific Standard Time (1600 to 0100 Universal Time) in winter and 0800 to 1700 Pacific Daylight Time (1500 to 0000 Universal Time) the rest of the year.

Unpacking SBE 21

Shown below is a typical SBE 21 shipment.



SBE 21



I/O cable
(SBE 21 to Interface Box)



Grounding cable
(from SBE 21)



4-pin RMG-4FS pigtail with
locking sleeve (from SBE 21
to Interface Box)



PN 90488 –
SEACAT/SEALOGGER
RS-232 and Navigation
Interface Box



AC power cable for
Interface Box



I/O cable
(Interface Box to computer)



NMEA Interface test cable
(Interface Box to NMEA device
simulation computer)



4-pin
MS connector
assembly
(for SEACAT data
I/O connector on
Interface Box)

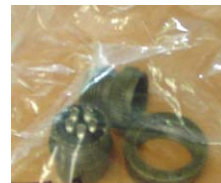

50369 5-pin
MS connector
assembly
(for NMEA Input
connector on
Interface Box)



Cell cleaning solution
(Triton X-100)



Jackscrew kit



SBE 21
User Manual



Software, and Electronic Copies of
Software Manuals and User Manual

Section 2: Description of SBE 21

This section describes the functions and features of the SBE 21, including specifications and dimensions.

System Description

The SBE 21 SEACAT Thermosalinograph is an externally powered, high-accuracy, conductivity and temperature recorder, designed for shipboard determination of sea surface (pumped-water) conductivity and temperature. Data is simultaneously transmitted to a computer's serial port and stored in 64 Mb FLASH RAM memory, allowing both real-time data acquisition and independent data logging. An internal lithium back-up battery in the SBE 21 supports the real-time clock when the main power supply is off.

Note:

Seasave 7.18 or later also supports acquisition of data from a NMEA device connected directly to the computer (instead of the interface box).

The SBE 21 is connected by cable to PN 90488 - SEACAT/SEALOGGER RS-232 and Navigation Interface Box. The Interface Box is AC-powered, provides isolated DC power and an optically-isolated RS-232 data interface for the SBE 21, and provides power and a NMEA 0183 receiver for a NMEA device (not supplied by Sea-Bird). The Interface Box appends NMEA information to the SBE 21 data stream.

The platinum-electrode glass conductivity cell's unique internal-field geometry eliminates proximity effects. This feature is critically important in thermosalinographs, where the cell must operate in a water jacket's confined volume. The internal-field cell also allows the use of expendable AF24173 Anti-Foulant Devices (supplied).

For corrosion resistance, only plastic, titanium, and the glass/platinum conductivity cell are exposed to seawater. Valves control seawater circulation and fresh water flushing. The sensor assembly is easily removed for cleaning and calibration.

The PVC base or back plate may be drilled for mounting to the ship. Seawater connections (for normal use) and fresh water connections (for cleaning) are PVC pipes with 1-inch (25.4 mm) U.S. standard NPT threads. Mating female fittings are provided, and can easily be adapted to locally available pipe sizes.

Communication with the SBE 21 is over an internal, 3-wire, RS-232C link, providing real-time data transmission. Commands can be sent to the SBE 21 to provide status display, data acquisition setup, data retrieval, and diagnostic tests. Output format is raw, hexadecimal data. The SBE 21 samples using one of the following user-programmable schemes:

- **Continuously at 4 Hz:** At pre-programmed 3- to 600-second intervals, the SBE 21 averages all the data from within the sampling interval, stores the average in memory, and sends the average to the computer (through the Interface Box).
- **At pre-programmed intervals:** At pre-programmed 3- to 600-second intervals, the SBE 21 takes one sample, stores the sample in memory, and sends the sample data to the computer (through the Interface Box).

A standard SBE 21 can record the output of an optional remote temperature sensor (SBE 38), allowing for the measurement of sea surface temperature with minimum thermal contamination from the ship's hull. A stainless steel and plastic in-line pipe mount is available for safe below-waterline installation of the remote temperature sensor (see *Section 3: Installing System*).

A standard SBE 21 is supplied with:

- Bulkhead connectors:
 - one 4-pin I/O connector
 - one 6-pin connector for A/D inputs (four single-ended or two differential channels – customer selects desired configuration at time of purchase)
 - one 4-pin connector for remote temperature sensor
 - one 1-pin connector for ground to ship's hull
- 64 Mbyte FLASH RAM memory
- Anti-foulant device attachments and expendable AF24173 Anti-Foulant Devices on each end of the conductivity cell.
- PN 90488 – SEACAT/SEALOGGER RS-232 and Navigation Interface Box, providing power to the SBE 21, an optically isolated RS-232 interface, a NMEA 0183 input port for NMEA data, and power for a NMEA device.

SBE 21 options include:

- Remote temperature sensor (SBE 38) and mounting kit
- Auxiliary A/D sensors (mounts not supplied)

Future upgrades and enhancements to the SBE 21 firmware can be easily installed in the field through a computer serial port and the I/O connector on the SBE 21, without the need to return the SBE 21 to Sea-Bird.

Notes:

- Help files provide detailed information on the software.
- Separate software manuals contain detailed information on Seasave V7 and SBE Data Processing.
- Sea-Bird also supplies an older version of Seasave, Seasave-Win32. However, all Seasave instructions in this manual are written for Seasave V7. See Seasave-Win32's manual and/or Help files if you prefer to use the older software.
- Sea-Bird supplies the current version of our software when you purchase an instrument. As software revisions occur, we post the revised software on our FTP site. See our website (www.seabird.com) for the latest software version number, a description of the software changes, and instructions for downloading the software from the FTP site.

The SBE 21 is supplied with a powerful Windows 2000/XP software package, SEASOFT[®] V2, which includes:

- **SEATERM** –terminal program for easy communication and data retrieval.
- **Seasave V7** –program for acquiring, converting, and displaying real-time or archived raw data.
- **SBE Data Processing** - program for calculation and plotting of conductivity, temperature, data from auxiliary sensors, and derived variables such as salinity and sound velocity.

Specifications

	Conductivity (S/m)	Primary Temperature (°C)	SBE 38 Secondary Temperature (°C)
Measurement Range	0 to 7	-5 to +35	-5 to +35
Initial Accuracy	0.001	0.01	0.001
Resolution	0.0001	0.001	0.0003
Calibration (measurement outside these ranges may be at slightly reduced accuracy due to extrapolation errors)	0 to 7; physical calibration over the range 2.6 to 6 S/m, plus zero conductivity (air)	+1 to +32	-1 to +32
Memory	64 Mbyte non-volatile FLASH memory		
Data Storage	Recorded Parameter		Bytes/sample
	temperature and conductivity		6 (3 each)
	each external voltage		2
	SBE 38 remote temperature		3
Real-Time Clock	32,768 Hz TCXO accurate to ±1 minute/year		
Sample Rate	1 sample / 3 seconds to 1 sample / 600 seconds Sample rate is incremented in 1-second steps		
Materials	PVC housing, water jacket, piping, and valves; titanium end cap		
Recommended Flow Rate	1 liter/second (15.8 gallons/minute)		
Auxiliary Voltage Sensors	Auxiliary power out: up to 500 mA at 10.5 - 11 VDC A/D resolution: 12 bits Input range: 0 - 5 VDC		
Maximum Safe Operating Pressure	34.5 decibars (50 psi)		
Weight	41 kg (90 lbs)		

Dimensions and Bulkhead Connectors

Dimensions in millimeters (inches)

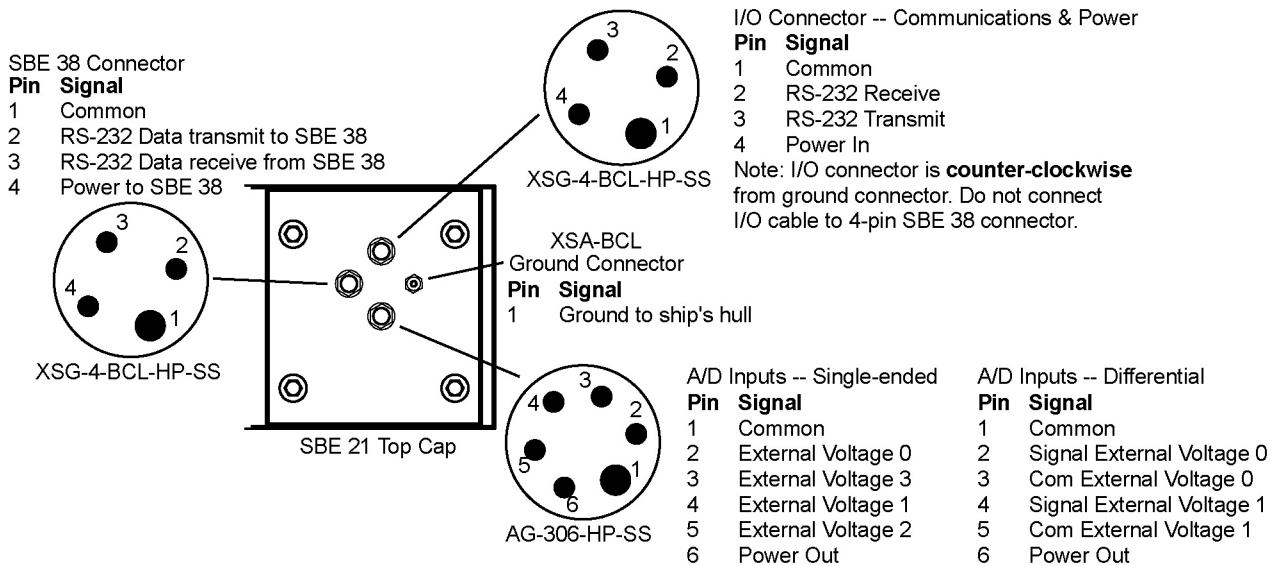
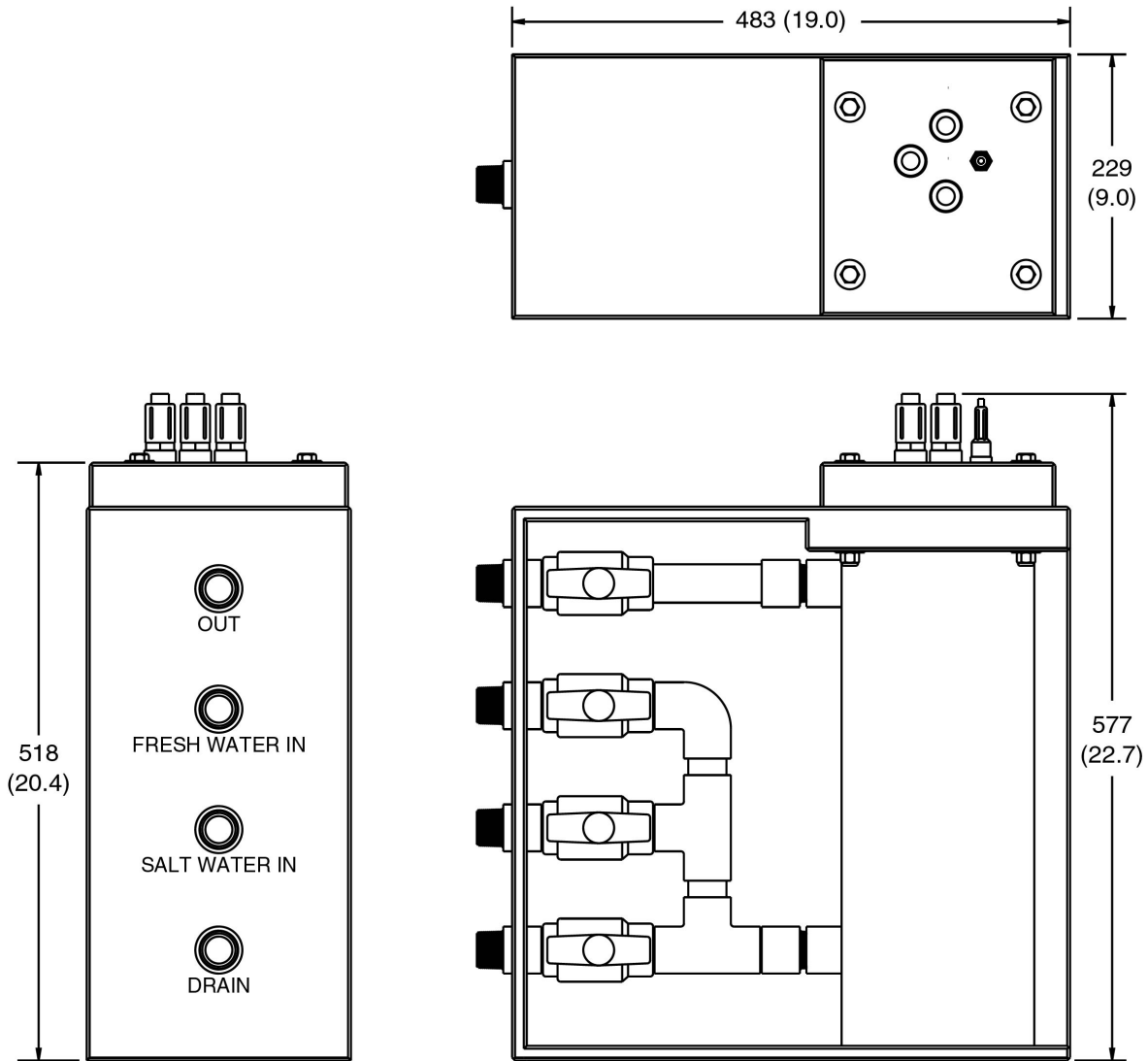

Data I/O

The SBE 21 receives set-up instructions and outputs diagnostic information or previously recorded data via a three-wire RS-232C link, and is factory-configured for 4800 baud, 7 data bits, 1 stop bit, and even parity. SBE 21 RS-232 levels are directly compatible with standard serial interface cards (IBM Asynchronous Communications Adapter or equal). The communications baud rate can be changed using **Baud=** (see *Command Descriptions* in *Section 4: Setting Up SBE 21*).

Data Storage

Note:

If FLASH memory is filled to capacity, sampling and transmission of real-time data continue, but excess data is not saved in memory. **The SBE 21 will not overwrite data stored in memory.**

The SBE 21 has a 64 Mbyte FLASH memory. See *Specifications* for storage space required for each parameter.

Example 1: no auxiliary sensors

T & C = 6 bytes/sample

Storage space $\approx 64,000,000 / 6 \approx 10,666,666$ samples

Example 2: 4 external voltages, SBE 38 remote temperature sensor

T & C = 6 bytes/sample

External voltages = 2 bytes/sample x 4 voltages = 8 bytes/sample

SBE 38 = 3 bytes/sample

Storage space $\approx 64,000,000 / (6 + 8 + 3) \approx 3,764,705$ samples

Remote Temperature Sensor (optional)



Note:

Sea-Bird software (Seasave real-time data acquisition and SBE Data Processing's Data Conversion and Derive modules) uses the data from the SBE 21's temperature sensor to calculate salinity, and then uses that salinity with the temperature from the remote temperature sensor to calculate density and sound velocity.

The SBE 21 can record the output of an external SBE 38 temperature sensor. Often, the SBE 21 is mounted in the interior of the vessel. In this configuration the recorded conductivity is correct, but the water temperature changed as it passed through the plumbing system. The SBE 38 can be placed in a location that provides more accurate measurement of the sea surface water temperature. **The ideal location for the SBE 38 is at the seawater intake (before the pump) near the bow of the ship.** This minimizes contamination of the surface temperature measurement by the ship's own thermal mass.

To compute salinity, always use the data from the temperature sensor on the SBE 21, not from the SBE 38. Conductivity has a strong thermal coefficient; therefore, it is critical to know the temperature of the water when the conductivity sensor samples it in order to compute salinity correctly. On a typical installation, there may be 20 to 30 meters of plumbing between the SBE 38 and the SBE 21. As the water flows through the pipes it changes temperature dramatically, making the data from the SBE 38 an inaccurate representation of the temperature when the water reaches the conductivity sensor. Use the SBE 38 only to report surface temperature, and to calculate density and sound velocity (density and sound velocity are a function of salinity and temperature).

Note that the SBE 38 can be added to the system at any time, and does not need to be part of the original order for the SBE 21. No modifications to the SBE 21 are required to integrate the SBE 38, other than programming the SBE 21 to accept the sensor signal and updating the configuration (.xmlcon or .con) file.

Section 3: Installing System

This section provides instructions for:

- Installing software
- Mounting and wiring the SBE 21 and Interface Box, including system schematic and installation guidelines, mechanical installation, and electrical installation

Installing Software

Notes:

- Help files provide detailed information on the software. Separate software manuals on the CD-ROM contain detailed information on Seasave V7 and SBE Data Processing.
- Sea-Bird also supplies an older version of Seasave, Seasave-Win32. However, all Seasave instructions in this manual are written for Seasave V7. See Seasave-Win32's manual and/or Help files if you prefer to use the older software.
- It is possible to use the SBE 21 without the SEATERM terminal program by sending direct commands from a dumb terminal or terminal emulator, such as Windows HyperTerminal.
- Sea-Bird supplies the current version of our software when you purchase an instrument. As software revisions occur, we post the revised software on our FTP site. See our website (www.seabird.com) for the latest software version number, a description of the software changes, and instructions for downloading the software from the FTP site.

Sea-Bird recommends the following minimum system requirements for installing the software: Windows 2000 or later, 500 MHz processor, 256 MB RAM, and 90 MB free disk space for installation. Although SEASOFT V2 was designed to work with a PC running Win 2000/XP; extensive testing has not shown any compatibility problems when using the software with a PC running Windows Vista.

If not already installed, install Sea-Bird software programs on your computer using the supplied software CD.

1. Insert the CD in your CD drive.
2. Install software: Double click on **SeasoftV2_date.exe** (*date* is the date that version of the software was created). Follow the dialog box directions to install the software. The installation program allows you to install the desired components. Install all the components, or just install SEATERM (terminal program), Seasave V7 (real-time data acquisition), and SBE Data Processing (data processing).

The default location for the software is c:\Program Files\Sea-Bird. Within that folder is a sub-directory for each component.

System Schematic and Installation Guidelines

Note:

Seasave 7.18 or later also supports acquisition of data from a NMEA device connected directly to the computer (instead of the interface box).

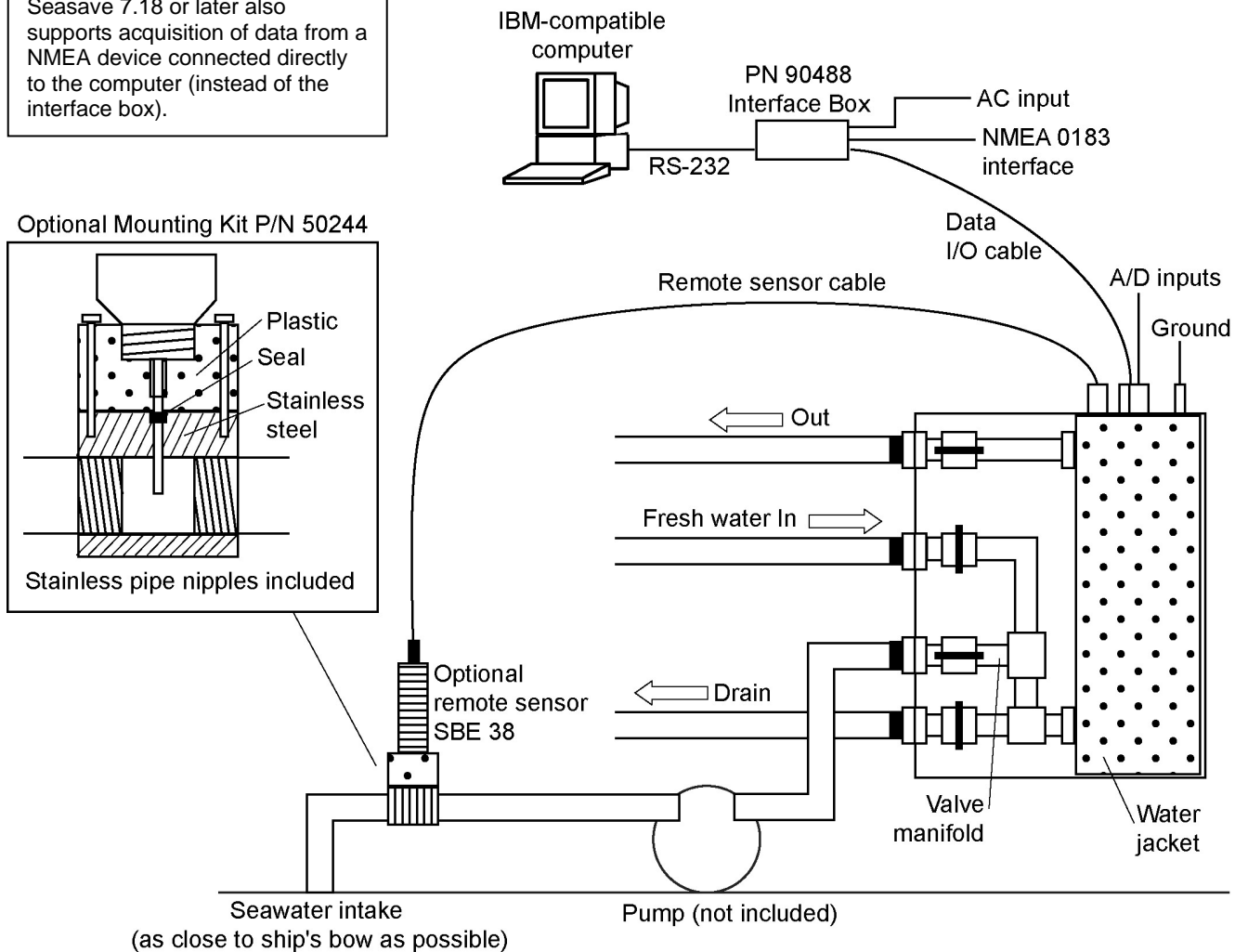

Valves are shown in normal operating position. Valves are open when handle is horizontal, closed when handle is vertical.

Sea-Bird does not provide detailed installation instructions for the SBE 21 and remote temperature sensor, given the unique nature of every ship and type of installation. The installation of the SBE 21 should be done by qualified shipfitters, with the oversight of a competent ship designer or naval architect.

Consider the following:

- The SBE 21 can be mounted anywhere it will *fit* that is accessible for maintenance and cleaning. **For safety, mount the SBE 21 above the water line.**
 - If the remote temperature sensor is not used, mount the SBE 21 as close to the seawater intake as possible to avoid thermal contamination of long plumbing runs. Thermal contamination will not affect salinity accuracy, but the SBE 21 will report the temperature of the water when it reaches the instrument.
 - If the remote temperature sensor is used, the SBE 21 can be mounted in the ship's lab or other convenient location.
 - The maximum recommended cable length from the SBE 21 to the Interface Box is 100 meters.
- Sea-Bird does not recommend or supply a pump. The pump should be able to provide 1 liter/second (15.8 gallons/minute) flow. Pressure at the SBE 21 is limited to 34.5 decibars (50 psi).
- Bubbles in the plumbing of a flow-through system are a common problem and will cause noisy salinity data. To minimize bubbles:
 - Place the pump below the water line to *push* rather than *pull* the water.
 - Locate the SBE 21's hull intake as deep as possible, as far as possible from bubble sources (bow wake, propeller, etc.)
- Depending on the chosen design of a permanent seawater supply (including pump, intake fitting, pipes, etc.), a de-bubbling device may be needed to separate bubbles from the water before it enters the SBE 21. Note that a de-bubbler may cause additional temperature errors for the SBE 21's primary temperature sensor; salinity accuracy (and accuracy of an optional remote temperature sensor) is not affected. Not all ships require de-bubblers, but many do for best quality salinity data. Large single point salinity spikes can be removed with the Wild Edit module in SBE Data Processing.
- Route cabling as cleanly as possible, avoiding sources of noise. Electric motors are a particular problem. Avoid routing the cable next to generators and air conditioners. Cables longer than 3 meters should be installed inside an earthed metal conduit by a qualified electrician. This minimizes the potential for external signals to disrupt communication and ensures that high voltage lines (such as the sea cable) are sufficiently protected. Cables shorter than 3 meters can be used without shielding when installing or bench testing the instrument.
- If practical, mount the optional SBE 38 remote temperature sensor outside the hull. However, the remote temperature sensor is usually mounted in the remote sensor mount kit, which has 1-inch pipe threads on each end; plumb the mount kit into your seawater system. Install the SBE 38 as close to the seawater intake as possible (before the pump), near the bow of the ship. Since the installation is below the water line, consult with your ship's engineer / naval architect / shipyard regarding the actual installation. Sea-Bird cannot offer advice in this matter as each ship is different and plumbing regulations vary.
- The SBE 21 can record a maximum of four auxiliary voltages from auxiliary sensors. However, Sea-Bird has not developed methods for the mechanical integration of these auxiliary sensors with the SBE 21. When integrating auxiliary sensors with the SBE 21, consider the following issues:
 - Install the sensors in a flow-through chamber that receives the outflow from the SBE 21.
 - Design the flow-through chamber so sensors can be removed and replaced for service and calibration.
 - Protect auxiliary sensors from bio-fouling.

Mechanical Installation



1. A new SBE 21 is shipped with AF24173 Anti-Foulant Devices pre-installed. Verify that the Devices are installed (see *Removing Sensor/Electronics Module from SBE 21 Water Jacket in Section 7: Routine Maintenance and Calibration* and *Appendix IV: AF24173 Anti-Foulant Device*).
2. Mount the SBE 21 at the desired location:
 - Orient the SBE 21 with the bulkhead connectors at the top.
 - Provide minimum top clearance of 559 mm (22 inches) for removal of the sensor/electronics module from the water jacket.
 - Drill the PVC base or back plate, and mount to the ship using machine bolts.
3. Install the piping connections to the SBE 21. The connectors are 1-inch (25.4 mm) National (USA) threads. Female mating fittings suitable for connecting to PVC plastic pipe with glue are provided; they may be modified for use with existing piping.
 - A. Connect the Out fitting to the shipboard drain or to the low pressure side of salt water supply.
 - B. Connect the Fresh Water In fitting to the shipboard fresh water supply.
 - C. Connect the Salt Water In fitting to the shipboard sea surface water intake line.
 - D. Connect the Drain fitting to shipboard drain.
4. Set the valves, as described in the following table. The valve is open when the handle is horizontal and closed when the handle is vertical.

Valve	Normal Use	Fresh Water Flushing	Storage, Cleaning, or Removal of Sensor/Electronics Module
Out	Open	Open	Closed
Fresh Water In	Closed	Open	Closed
Salt Water In	Open	Closed	Closed
Drain	Closed	Closed	Closed

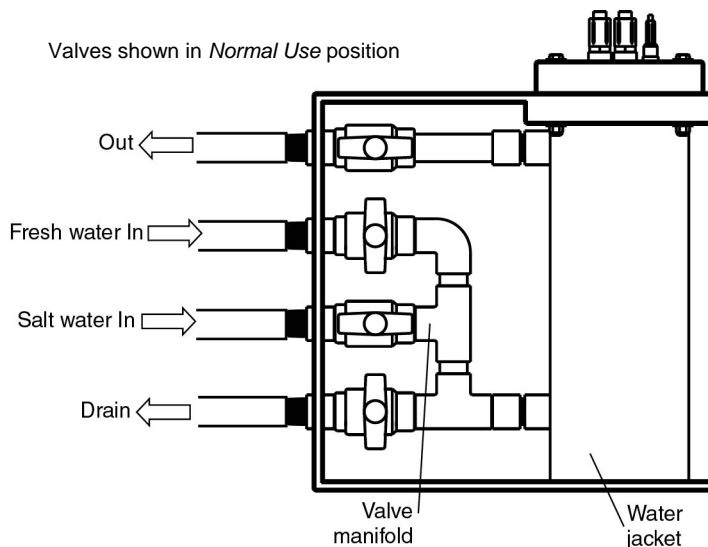

Electrical Installation

Connecting SBE 21 to Interface Box

1. Locate the Interface Box near the computer.
 - If the distance between the SBE 21 and Interface Box is longer than the provided 10 meter I/O cable, cut the cable and splice it into the ship's cable. The ship's cable should have 3 conductors, preferably with at least 2 of the conductors shielded (RS-232 TX and RX) if engine ignition noise or other EM interference might be encountered. See drawing number 31063 for cable wiring details.
2. Connect the I/O cable to the SBE 21:
 - A. By hand, unscrew the locking sleeve from the SBE 21's I/O (4-pin) connector. If you must use a wrench or pliers, be careful not to loosen the I/O connector instead of the locking sleeve.
 - B. Remove the dummy plug from the SBE 21's I/O connector by pulling the plug firmly away from the connector.
 - C. Lightly lubricate the inside of the 4-pin cable connector with silicone grease (DC-4 or equivalent).
 - D. Install the 4-pin cable connector on the SBE 21, aligning the raised bump on the side of the connector with the large pin on the SBE 21's bulkhead connector. Remove any trapped air by *burping* or gently squeezing the connector near the top and moving your fingers toward the end cap.
 - E. Place the locking sleeve over the cable connector. Tighten the locking sleeve finger tight only. **Do not overtighten the locking sleeve, and do not use a wrench or pliers.**
3. Connect the MS-style metal shell connector on the I/O cable to *SBE 21* on the Interface Box.

CAUTION:

Do not use WD-40 or other petroleum-based lubricants, as they will damage the connector.

Note:

Follow the procedure in Steps 2A through 2E for proper installation of all cables with similar connectors.



Connecting SBE 21 to Ground and to Auxiliary Sensors

1. Connect the SBE 21's 1-pin ground connector to ship's ground.
2. (optional) Install the cable between the SBE 21 and optional SBE 38 Remote Temperature Sensor.
3. (optional) Install the cable(s) for optional auxiliary voltage sensors.

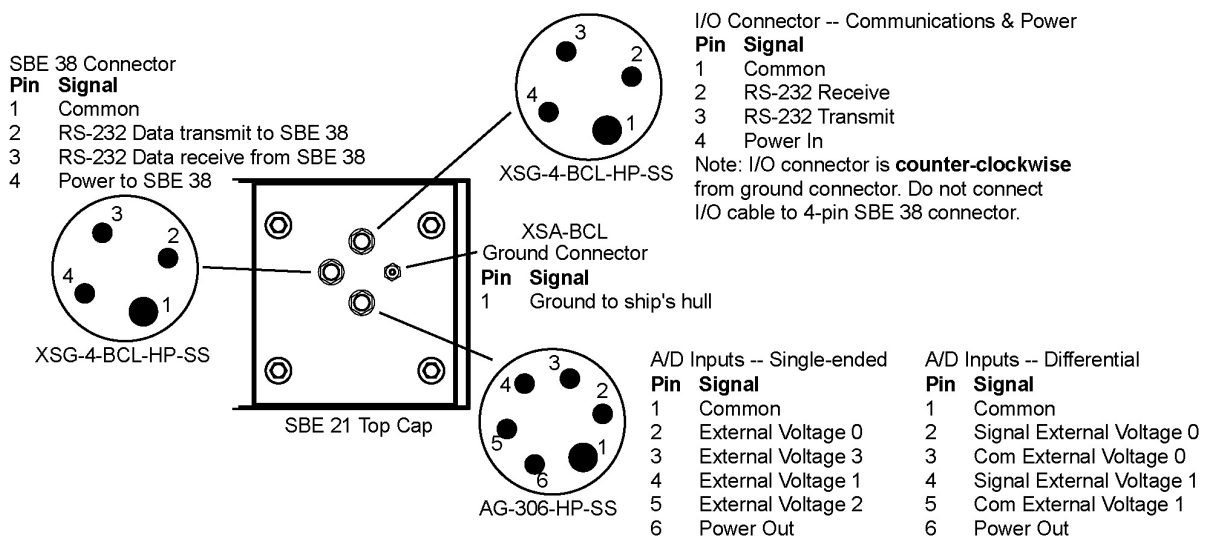

Connecting Interface Box



1. Connect *Serial* on the Interface Box to the computer using the DB-9S to DB-9P cable.
2. Connect the Interface Box *AC Input* to a standard, 3-prong, grounded, AC outlet, using the UL/IEC-approved power cord (AC voltage between 85-270 VAC).
3. (optional) Connect a NMEA device to *NMEA* on the Interface Box with the 5-pin MS connector (MS3106A14S-5P). The connector pin designations are:



Interface Box	Function
Pin A	Optional power return
Pin B	NMEA A (signal)
Pin C	NMEA B (signal return)
Pin D	No connection
Pin E	Optional +12 DC power out, up to 2 amps

Section 4: Setting Up SBE 21

This section describes:

- Setting communications parameters in the Interface Box
- Testing power and communications and setting up the SBE 21 in SEATERM
- Command descriptions
- Setting up the configuration (.xmlcon or .con) file in Seasave
- Data format

Setting Communications Parameters in Interface Box

Notes:

- Although baud rates **may** be set higher than the factory defaults, some users experience dropped characters with higher baud rates.
- The baud rate between the Interface Box and computer must be equal to or higher than the baud rate between the SBE 21 and Interface Box.

The PN 90488 Interface Box is shipped with default communication settings that are compatible with operation with the SBE 21:

- 9600 baud for Interface box to computer
- 4800 baud for SBE 21 to Interface Box
- 7 data bits, even parity (SBE 21 to Interface Box and Interface Box to computer)
- 4800 baud for NMEA device to Interface Box

If you want to change these settings, or you are using an Interface Box that was set up for use with a different CTD, see the Interface Box manual for details on changing communication settings.

Power and Communications Test and SBE 21 Setup in SEATERM

Notes:

- See SEATERM's help files.
- It is possible to use the SBE 21 without SEATERM by sending direct commands from a dumb terminal or terminal emulator, such as Windows HyperTerminal.

1. Wire the SBE 21 to the Interface Box, wire the Interface Box to the computer, and provide power to the Interface Box, as described in *Electrical Installation* in *Section 3: Installing System*.
2. Double click on SeaTerm.exe. If this is the first time the program is used, the setup dialog box may appear:

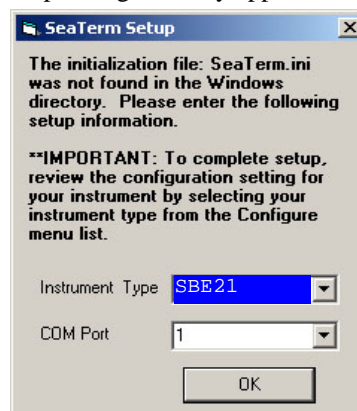

Select the instrument type (SBE 21) and the computer COM port for communication with the SBE 21. Click OK.

3. The main screen looks like this:

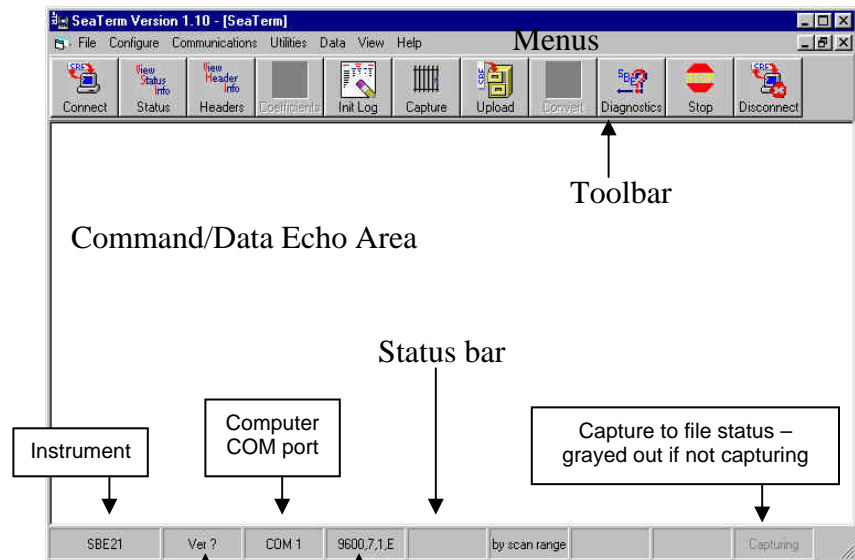
**Note:**

There is at least one way, and as many as three ways, to enter a command:

- Manually type a command in Command/Data Echo Area
- Use a menu to automatically generate a command
- Use a Toolbar button to automatically generate a command

- **Menu** – Contains tasks and frequently executed instrument commands.
- **Toolbar** – Contains buttons for frequently executed tasks and instrument commands. All tasks and commands accessed through the Toolbar are also available in the Menu. To display or hide the Toolbar, select View Toolbar in the View menu. Grayed out Toolbar buttons are not applicable.
- **Command/Data Echo Area** – Echoes a command executed using a Menu or Toolbar button, as well as the instrument's response. Additionally, a command can be manually typed in this area, from the available commands for the instrument. Note that the instrument must be *awake* for it to respond to a command (use Connect on the Toolbar to wake up the instrument).
- **Status bar** – Provides status information. To display or hide the Status bar, select View Status bar in the View menu.

Following are the Toolbar buttons applicable to the SBE 21:

Toolbar	Description	Equivalent Command*
Connect	Re-establish communications with SBE 21.	(press Enter key)
Status	Display instrument setup and status (logging, samples in memory, etc.).	DS
Headers	View data headers (header number, date and time, first and last sample, and sample interval). New header is generated at start of logging and every subsequent 10,000 scans.	DH
Init Log	Reset data pointers and cast numbers. This should be performed after existing data has been uploaded from SBE 21 and prior to recording new data.	IL
Capture	Capture instrument responses on screen to file; may be useful for diagnostics. File has .cap extension. Press Capture again to turn off capture. Capture status displays in Status bar.	—
Upload	Upload data stored in memory, in format Sea-Bird's post-processing software can use. Uploaded data has .hex extension. Before using Upload: <ul style="list-style-type: none"> • Configure upload and header parameters in Configure menu. • Stop logging by sending QL. 	DD (use Upload key if will be data processing with SBE Data Processing)
Diagnostics	Perform one or more diagnostic tests on SBE 21. Test(s) accessed in this manner are non-destructive—they do not write over any existing instrument settings.	DS, FR, and VR
Stop	Interrupt and end current activity, such as uploading or diagnostic test.	(press Esc key or Ctrl C)
Disconnect	Free computer COM port used to communicate with SBE 21. COM port can then be used by another program.	—

*See *Command Descriptions*.

4. In the Configure menu, select SBE 21. The dialog box looks like this:

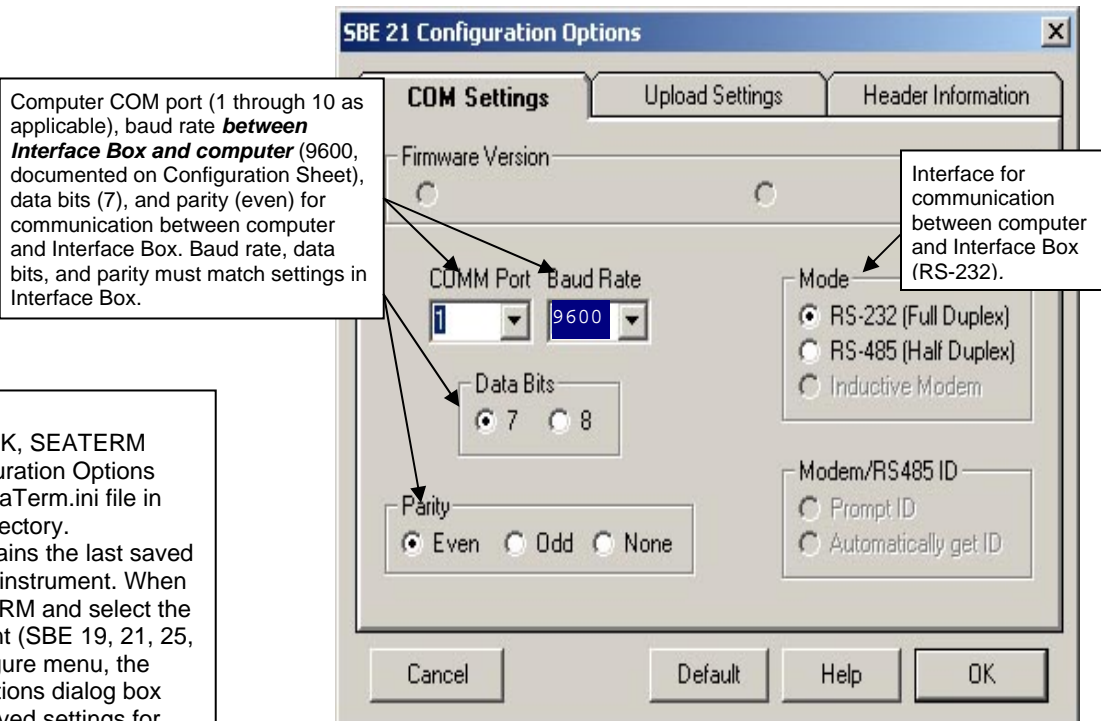

Note:

When you click OK, SEATERM saves the Configuration Options settings to the SeaTerm.ini file in your Windows directory. SeaTerm.ini contains the last saved settings for **each** instrument. When you open SEATERM and select the desired instrument (SBE 19, 21, 25, etc.) in the Configure menu, the Configuration Options dialog box shows the last saved settings for that instrument.

Make the selections in the Configuration Options dialog box. Click OK to save the settings.

5. Turn on power to the Interface Box. The red PWR LED should light. The display in SEATERM looks like this:

```
Interface box v 3.1b setup:
PC baud rate = 9600
SEACAT baud rate = 4800
7 data bits, even parity
NMEA baud rate = 4800
start mode = Echo characters to and from the instrument
NMEA message to decode = GGA, GLL, RMA, RMC, TRF, DBT, DPT
Press @ to change the interface box setup
```

This shows that correct communications **between the computer and Interface Box** has been established. If the system does not respond as shown:

- Verify the SBE 21 was selected in the Configure menu and the settings were entered correctly in the dialog box.
- Check cabling between the computer and Interface Box.

Notes:

- See *Section 5: Setting Up NMEA Interface* for details on the setup menu.
- If the SBE 21 is set up to automatically start sampling when power is applied (**AutoRun=Y**), the Interface Box setup is followed by hex data output from the SBE 21.

Note:

- The Interface Box must be in Mode 1 (echo characters to and from the instrument) when sending commands to the SBE 21.
- If you select option 4 (you have a NMEA depth device as well as a NMEA position device), the mode 2 description changes to:
2. Add Lat/Lon/**Depth** to the real-time HEX data from the instrument

6. **If the start mode is not echo characters to and from the instrument:** type @ to access the setup menu. The display looks like this:

Interface Box set up menu:

Modes:

1. Echo characters to and from the instrument
2. Add Lat/Lon to the real-time HEX data from the instrument
3. Transmit Lat/Lon only

Options:

4. Add NMEA Depth to the real-time HEX/Lat/Lon data
5. Do not add NMEA Depth to the real-time HEX/Lat/Lon data

Communications:

6. Change communication settings and start mode
7. Display communication settings and start mode

Diagnostics:

8. enable diagnostic level 1
9. enable diagnostic level 2

the current mode = 1. Echo characters to and from the instrument

enter 1, 2, 3, 4, 5, 6, 7, 8, or 9 followed by Enter, or press @ to exit the set up menu

selection =

Type 1 and press the Enter key. The display then shows the current mode as 1. *Echo characters to and from the instrument*, which is the mode required for communicating with the SBE 21 to set it up. Type @ to exit the setup menu.

7. Click Connect on the Toolbar or press the Enter key several times. **If you used Connect on the Toolbar**, the display looks like this:

```
*ds
```

```
SC21, 4300, 5.0a, 0, 0, 6, N
```

This is a factory-diagnostic status command (*ds) and reply. The reply indicates instrument serial number [4300], firmware version [5.0a], number of samples in memory [0], number of headers in memory [0], number of bytes in each scan [6], and whether the SBE 21 is logging [L] or not logging [N].

If the system does not respond:

- Click Connect again or press the Enter key several times.
- Verify the correct instrument was selected in the Configure menu and the settings were entered correctly in the Configuration Options dialog box. The baud rate is documented on the instrument Configuration Sheet.
- Check cabling between the computer, Interface Box, and SBE 21.

8. Display SBE 21 status information by clicking Status on the Toolbar. The display looks like this:

```
SEACAT THERMOSALINOGRAPH V5.0a SERIAL NO. 4300 12/15/2009 14:23:14
ioper = 50.7 ma,      vmain = 11.4,      vlith = 8.8
samples = 0, free = 10966357
sample interval = 5 seconds, no. of volts sampled = 0
output format = SBE21
start sampling when power on = no
average data during sample interval = yes
logging data = no
voltage cutoff = 7.5 volts
```

9. If the status reply indicates that the SBE 21 is logging, command the SBE 21 to stop logging by pressing the Enter key and sending **QL**. You may need to send **QL** several times before the SBE 21 responds.
q1
logging stopped, stop command
10. Command the SBE 21 to take a sample by typing **TS** and pressing the Enter key. The display looks like this (if output format=SBE 21, number of volts sampled=0, and no external temperature sensor):
78610428
where 7861 = raw Hex temperature data
 0428 = raw Hex conductivity data
See *Data Formats* to interpret the data and determine if they are reasonable (i.e., room temperature and zero conductivity if running in air, or expected temperature and conductivity for water).
11. Set up the SBE 21 as desired (see *Command Descriptions*).
12. Command the SBE 21 to go to sleep (quiescent state) by typing **QS** and pressing the Enter key.
13. Turn off power to the Interface Box.

Command Descriptions

This section describes commands in detail and provides examples of their use. See *Appendix III: Command Summary* for a summarized command list.

Commands are entered in SEATERM. When entering commands:

- Input commands in upper or lower case letters and register commands by pressing the Enter key.
- The SBE 21 sends an error message if an invalid command is entered.
- (if **OutputExecutedTag=N**) If the SBE 21 does not return an S> prompt after executing a command, press the Enter key to get the S> prompt.
- If a new command is not received within 2 minutes after completion of a command, the SBE 21 sends a message `<ERRORType = 'TIMEOUT' msg = 'NO COMMAND RECEIVED'/>` and returns to the quiescent (sleep) state.
- If in quiescent state, re-establish communications by clicking Connect on the Toolbar or pressing the Enter key.
- If the SBE 21 is logging and transmitting data and you want to send a command, press the Esc key or click Stop on the Toolbar (or type Ctrl C) and then press the Enter key. This **temporarily** stops logging that is in progress, and allows you to enter a limited number of commands (**GetCD**, **GetSD**, **GetCC**, **GetEC**, **ResetEC**, **GetHD**, **DS**, **DCal**, **SS**, **TS**, **QL**, and **QS** can be entered while logging). After 30 seconds elapses without transmission of a command, logging resumes.
- The SBE 21 cannot have samples with different scan lengths (more or fewer data fields per sample) in memory. If the scan length is changed by commanding it to add or subtract a data field (such as an external voltage), the SBE 21 must initialize logging. Initializing logging sets the sample number and header number to 0, so the entire memory is available for recording data with the new scan length. **Initializing logging should only be performed after all previous data has been uploaded.** Therefore, commands that change the scan length (**SV=x** and **SBE38=**) prompt the user for verification before executing, to prevent accidental overwriting of existing data.
- The Interface Box must be in Mode 1 (Echo characters to and from the instrument) when sending commands to the SBE 21.

Entries made with the commands are permanently stored in the SBE 21 and remain in effect until you change them.

- The only exception occurs if J1 is removed from the Power PCB (top board in PCB assembly) to replace the back-up lithium battery or to do a reset of the instrument. Upon reassembly, set the date and time (**DateTime=**) and initialize logging (**IL**). (See *Appendix II: Electronics Disassembly/Reassembly* for details on accessing the PCBs. See *Section 8: Troubleshooting* for details on performing a reset of the instrument.)

Status Command

Note:

The **DS** response contains similar information as the combined responses from **GetSD** and **GetCD**, but in a different format.

GetCD

Get and display configuration data, which includes all parameters related to setup of SBE 21, including communication settings and sampling settings. Most of these parameters can be user-input/modified. List below includes, where applicable, command used to modify parameter:

- Device type, Serial number
- Sample interval [**SI=**]
- Start sampling automatically when power on [**AutoRun=**]?
- Average data during sample interval [**Average=**]?
- Sample external voltages 0, 1, 2, and 3 [**SV=** sets number of channels]?
- Sample SBE 38 remote temperature sensor [**SBE38=**]?
- Output format [**Fx**]
- Output Executing and Executed tags [**OutputExecutedTag=**]?

Example: Send **GetCD** to SBE 21 (user input in bold, command used to modify parameter in parentheses)

getcd

```

<ConfigurationData DeviceType='SBE21' SerialNumber='02106001'>
  <SampleMode>
    <SampleInterval>15</SampleInterval>                                [SI=]
    <AutoRun>no</AutoRun>                                              [AutoRun=]
    <Average>no</Average>                                             [Average=]
  </SampleMode>
  <DataChannels>
    <ExtVolt0>yes</ExtVolt0>                                           [SV= sets number of voltage channels]
    <ExtVolt1>yes</ExtVolt1>                                           [SV= sets number of voltage channels]
    <ExtVolt2>no</ExtVolt2>                                             [SV= sets number of voltage channels]
    <ExtVolt3>no</ExtVolt3>                                             [SV= sets number of voltage channels]
    <SBE38>no</SBE38>                                                  [SBE38=]
  </DataChannels>
  <OutputFormat>SBE 21</OutputFormat>                                  [Fx]
  <OutputExecutedTag>no</OutputExecutedTag>                          [OutputExecutedTag=]
</ConfigurationData>

```

Status Commands (*continued*)**Note:**

The **DS** response contains similar information as the combined responses from **GetSD** and **GetCD**, but in a different format.

GetSD

Get and display status data, which contains data that changes while deployed.

List below includes, where applicable, command used to modify parameter:

- Device type, Serial number
- Date and time [**DateTime=**] in ISO8601-2000 extended format (yyyy – mm-ddThh:mm:ss)
- Logging status (not logging, logging, or unknown status)
- Number of recorded events in event counter [reset with **ResetEC**]
- Voltages and currents -
 - External power
 - Back-up lithium battery voltage
 - Operating current
 - External voltage sensor current – displays only if 1 or more voltage channels enabled
 - RS-232 sensor current – displays only if channel enabled
- Memory - [reset with **IL**]
 - Number of bytes in memory
 - Number of samples in memory
 - Number of additional samples that can be placed in memory
 - Length (number of bytes) of each sample

Example: (user input in bold, command used to modify parameter in parentheses)

getsd

```
<StatusData DeviceType = 'SBE21' SerialNumber = '02106001'>
  <DateTime>2009-12-22T10:53:03</DateTime>
  <LoggingState>not logging</LoggingState>
  <EventSummary numEvents = '0' />
  <Power>
    <vMain>11.5</vLith>
    <vLith>8.9</vLith>
    <iMain>61.9</iMain>
    <iExt>67.2</iExt>
    <iSerial>67.2</iSerial>
  </Power>
  <MemorySummary>
    <Bytes>0</Bytes>
    <Samples>0</Samples>
    <SamplesFree>3870479</SamplesFree>
    <SampleLength>17</SampleLength>
  </MemorySummary>
</StatusData>
```

[**DateTime=**]

[can clear with **ResetEC**]

[can clear with **IL**]

[can clear with **IL**]

[can clear with **IL**]

Status Commands (*continued*)**Note:**

Calibration coefficients for the conductivity and primary temperature sensor, and for any auxiliary sensors, are stored in the SBE 21's configuration (.xmlcon or .con) file. View and/or modify the calibration coefficients using the Configure menu in SBE Data Processing or Seasave (see *Checking SBE 21 Configuration (.xmlcon or .con) File in Seasave*).

GetCC

Get and display calibration coefficients:

- Voltage (0, 1, 2, and 3) channel offset and slope, as determined at Sea-Bird:
Output voltage =
(slope * calculated V from sensor equation) + offset
- conductivity zero frequency: characteristic frequency of conductivity sensor for 0 conductivity, as determined at Sea-Bird from a cell thoroughly rinsed in distilled or de-ionized water, with all the water shaken out. Zero frequency that has changed by a few tenths of a Hz indicates a dirty cell. Zero frequency that has changed by more may indicate a cell that is damaged or considerably out of calibration.

Example: SBE 21 (user input in bold, command used to modify coefficient in parentheses)

getcc

```
<CalibrationCoefficients DeviceType = 'SBE21' SerialNumber = '02106001'>
  <Calibration format = 'VOLT0' id = 'Volt 0'>
    <OFFSET>0.000000e+00</OFFSET> [VOffset0=]
    <SLOPE>1.260977e+00</SLOPE> [VSlope0=]
  </Calibration>
  <Calibration format = 'VOLT0' id = 'Volt 1'>
    <OFFSET>-4.728750e-02</OFFSET> [VOffset1=]
    <SLOPE>1.259474e+00</SLOPE> [VSlope1=]
  </Calibration>
  <Calibration format = 'VOLT0' id = 'Volt 2'>
    <OFFSET>-4.715313e-02</OFFSET> [VOffset2=]
    <SLOPE>1.259946e+00</SLOPE> [VSlope2=]
  </Calibration>
  <Calibration format = 'VOLT0' id = 'Volt 3'>
    <OFFSET>-4.772396e-02</OFFSET> [VOffset3=]
    <SLOPE>1.260486e+00</SLOPE> [VSlope3=]
  </Calibration>
  <Calibration format = 'CF0' id = 'conductivity zero frequency'>
    <CF0>2.689054e+03</CF0>
  </Calibration>
</CalibrationCoefficients>
```

Status Commands (*continued*)**GetEC**

Get and display event counter data, which can help to identify root cause of a malfunction. Event counter records number of occurrences of common timeouts, power-on resets, etc. Can be cleared with **ResetEC**. Possible events that may be logged include:

- Power fail – external power below voltage cutoff
- EEPROM read or EEPROM write – all power removed (external power removed, and back-up lithium batteries are dead)
- AD7730 timeout – response from temperature A/D converter delayed; typically if woke up to send a command while logging
- AD7714 timeout – response from voltage channel A/D converter delayed; typically if woke up to send a command while logging
- FLASH out of memory – all available memory space is used; autonomous sampling continues, but no additional data written to FLASH (does not overwrite)
- FLASH correctable error – single bit error in a page, corrects itself, does not affect data
- FLASH ECC error – does not affect data
- FLASH timeout – problem with FLASH
- FLASH ready – problem with FLASH; timeout error
- FLASH erase failed – problem with FLASH
- FLASH write failed – problem with FLASH
- FLASH uncorrectable – problem with FLASH; 2 or more bits of errors in a page
- FLASH block overrun – problem with FLASH
- New bad block – problem with FLASH; FLASH write or erase failed, or a FLASH uncorrectable error

Example (user input in bold, command used to modify parameter in parentheses)

getec

```
<EventCounters DeviceType = 'SBE21' SerialNumber = '02106001'>
  <EventSummary numEvents = '1' />
  <Event type='powerfail' count='1' />
</EventCounters>
```

[can clear with **ResetEC**]

ResetEC

Delete all events in event counter (number of events displays in **GetSD** response, and event details display in **GetEC** response).

Status Commands (*continued*)**GetHD**

Get and display hardware data, which is fixed data describing SBE 21:

- Device type, Serial number
- Manufacturer
- Firmware version
- Firmware date
- PCB serial number and assembly number
- Manufacture date
- Internal sensor types and serial numbers
- External voltage sensor types (for example, dissolved oxygen, fluorometer, etc.) and serial numbers

Note:

External sensor types and serial numbers can be changed in the field, to accommodate changes in auxiliary sensors cabled to the SBE 21.

Other hardware data is typically not changed by the user.

Example: (user input in bold, command used to modify parameter in parentheses)

gethd

```

<HardwareData DeviceType = 'SBE21' SerialNumber = '02106001'>
  <Manufacturer>Sea-Bird Electronics, Inc.</Manufacturer>
  <FirmwareVersion>5.0a</FirmwareVersion>
  <FirmwareDate>2 September 2009 09:00</FirmwareDate>
  <PCBAssembly PCBSerialNum = 'not assigned' AssemblyNum = 'not assigned' />
  <PCBAssembly PCBSerialNum = 'not assigned' AssemblyNum = 'not assigned' />
  <PCBAssembly PCBSerialNum = 'not assigned' AssemblyNum = 'not assigned' />
  <PCBAssembly PCBSerialNum = 'not assigned' AssemblyNum = 'not assigned' />
  <MfgDate>03 february 2008</MfgDate>
  <InternalSensors>
    <Sensor id = 'Main Temperature'>
      <type>temperature0</type>
      <SerialNumber>01606001</SerialNumber>
    </Sensor>
    <Sensor id = 'Main Conductivity'>
      <type>conductivity-0</type>
      <SerialNumber>01606001</SerialNumber>
    </Sensor>
  </InternalSensors>
  <ExternalSensors>
    <Sensor id = 'volt 0'>
      <type>not assigned</type>
      <SerialNumber>not assigned</SerialNumber>
    </Sensor>
    <Sensor id = 'volt 1'>
      <type>not assigned</type>
      <SerialNumber>not assigned</SerialNumber>
    </Sensor>
    <Sensor id = 'volt 2'>
      <type>not assigned</type>
      <SerialNumber>not assigned</SerialNumber>
    </Sensor>
    <Sensor id = 'volt 3'>
      <type>not assigned</type>
      <SerialNumber>not assigned</SerialNumber>
    </Sensor>
  </ExternalSensors>
</HardwareData>

```

[SetPcbSerialNum1=, SetPCBAssembly1=]
 [SetPcbSerialNum2=, SetPCBAssembly2=]
 [SetPcbSerialNum3=, SetPCBAssembly3=]
 [SetPcbSerialNum4=, SetPCBAssembly4=]
 [SetMfgDate=]

[SetVoltType0=]
 [SetVoltSN0=]

[SetVoltType1=]
 [SetVoltSN1=]

[SetVoltType2=]
 [SetVoltSN2=]

[SetVoltType3=]
 [SetVoltSN3=]

Status Commands (*continued*)**DS**

Display operating status and setup parameters. Equivalent to Status on Toolbar.

List below includes, where applicable, command used to modify parameter.

- firmware version, serial number, and date and time [**DateTime=**]
- operating current (milliamps), external power voltage, and lithium battery voltage
- number of samples and available sample space in memory
- sample interval [**SI=**], number of external voltages enabled [**SV=**]
- Enable sampling of SBE 38 remote temperature sensor [**SBE38=**?]
(only appears in status if SBE 38 enabled)
- output format [**Fx**]
- start sampling automatically when power on [**AutoRun=**?]
- average data during sample interval [**Average=**?]
- logging status
- power cutoff voltage

Example: Display status for SBE 21 that has SBE 38 remote temperature sensor enabled (user input in bold).

DS

```
SEACAT THERMOSALINOGRAPH V5.0a SERIAL NO. 4300 12/15/2009 14:23:14 [DateTime=]
ioper = 50.7 ma,          vmain = 11.4,          vlith = 8.8
samples = 0, free = 3870479
sample interval = 5 seconds, no. of volts sampled = 4           [SI=, SV=]
sample external SBE 38 temperature sensor                       [SBE38=]
output format = SBE21                                          [Fx]
start sampling when power on = no                               [AutoRun=]
average data during sample interval = yes                       [Average=]
logging data = no
voltage cutoff = 7.5 volts
```

Notes:

- Calibration coefficients for the conductivity and primary temperature sensor, and for any auxiliary voltage sensors, are stored in the SBE 21's configuration (.xmlcon or .con) file. View and/or modify the calibration coefficients using the Configure menu in SBE Data Processing or Seasave (see *Checking SBE 21 Configuration (.xmlcon or .con) File in Seasave*).
- If using an SBE 38 remote temperature sensor, its calibration coefficients are not stored in the SBE 21 EEPROM or in the SBE 21's configuration (.xmlcon or .con) file. View and/or modify the instrument's calibration coefficients by connecting the instrument to the computer directly and using SEATERM.

Status Commands (*continued*)**DCal**

Display calibration coefficients.

- Voltage (0, 1, 2, and 3) channel offset and slope, as determined at Sea-Bird:
Output voltage =
(slope * calculated V from sensor equation) + offset
- conductivity zero frequency: characteristic frequency of conductivity sensor for 0 conductivity, as determined at Sea-Bird from a cell thoroughly rinsed in distilled or de-ionized water, with all the water shaken out. Zero frequency that has changed by a few tenths of a Hz indicates a dirty cell. Zero frequency that has changed by more may indicate a cell that is damaged or considerably out of calibration.

Example: Display coefficients for SBE 21 (user input in bold).

DCAL

```
SEACAT THERMOSALINOGRAPH V5.0a SERIAL NO. 3166 12/15/2009 14:30:14
volt 0: offset = -4.662333e-02, slope = 1.249281e+00
volt 1: offset = -4.658000e-02, slope = 1.249034e+00
volt 2: offset = -4.699667e-02, slope = 1.248704e+00
volt 3: offset = -4.707333e-02, slope = 1.249847e+00
Cfo = 2596.697
```

Setup Commands

DateTime=mmddyyyyhhmmss Set real-time clock month, day, year, hour, minute, and second.

Example: Set current date and time to 05 February 2010 12:05:00 (user input in bold).

```
datetime=02052010120500
```

Note:

The SBE 21 baud rate (set with **Baud=**) must match the Interface Box setup for baud rate between the SBE 21 and Interface Box.

Baud=x x= baud rate (600, 1200, 2400, 4800, 9600, 19200, or 38400). Default 4800.

OutputExecutedTag=x x=**Y**: Display XML Executing and Executed tags (*default*). Executed tag displays at end of each command response; Executing tag displays one or more times if SBE 21 response to command requires additional time.

x=**N**: Do not.

Example: Set SBE 21 to output Executed and Executing tags (user input in bold).

```
outputexecutedtag=y
<Executed/>getcd
. . . (GetCD response)
<Executed/>
```

(Note: <Executed/> tag at end of command response takes place of S> prompt.)

Notes:

- See *Notes on SBE 38 Remote Temperature Data Format* for details on how the SBE 38 data is handled.
- The SBE 21 configuration (.xmlcon or .con) file must match the selection of remote temperature sensor and external voltages. View and edit the configuration file in Seasave or SBE Data Processing. These parameters are factory-set to match the ordered instrument configuration.
- The SBE 21 requires verification when **SBE38=** or **SV=x** are sent. The SBE 21 responds: `This command will change the scan length and/or initialize logging. Repeat the command to verify. Type the command again and press the Enter key to proceed. The SBE 21 responds: Scan length has changed, initializing logging.`

SBE38=x

x= Y: Enable sampling of SBE 38 remote temperature sensor.

Note: **You must also set up SBE 38 to interface with SBE 21.** Connect SBE 38 directly to computer, and set:

- SBE 38 baud (**Baud=**) to same baud as SBE 21;
 - interface to RS-232 (**Interface=232**);
 - sampling to begin when power applied (**AutoRun=Y**); and
 - format to converted data (**Format=C**).
- See SBE 38 manual for command details.

x= N: Do not enable SBE 38.

SV=x

x= number of external voltages to be acquired (0, 1, 2, 3, or 4). Maximum is 4 if single-ended A/D channels are installed, or 2 if differential A/D channels are installed.

Fx

x=1: Set data format to SBE 21. Outputs raw data (in Hex): primary temperature, conductivity, remote temperature, voltages.

x=2: Set data format to SBE 16 (custom applications not using Sea-Bird software). Outputs raw data (in Hex): # (attention character), primary temperature, conductivity, remote temperature, voltages, linear count (starting at 0).

Notes:

- Output format does not affect how data is stored in memory.
- **If you will be using Sea-Bird software (Seasave and/or SBE Data Processing), set the format to SBE 21 (F1).**
- See *Data Formats* for a complete description of the data output.

QS

Quit session and place SBE 21 in quiescent (sleep) state. Quiescent current is only 30 microamps. Memory retention is not affected.

Logging Commands

Notes:

- In SEATERM, to save real-time data to a file, click Capture on the Toolbar before beginning logging.
- If the FLASH memory is filled to capacity, data sampling and transmission of real-time data continue, but excess data is not saved in memory. **The SBE 21 will not overwrite data stored in memory.**
- If the maximum number of headers is reached but there is still room for samples in FLASH memory, data sampling and transmission of real-time data continue without writing additional headers.
- If the SBE 21 is logging data and the external voltage is less than the cut-off voltage (7.5 volts), the SBE 21 halts logging and displays: logging stopped, no power

Logging commands configure the SBE 21's response upon waking up, and direct the SBE 21 to sample data at pre-programmed intervals. When commanded to start sampling with **GL** or **RL**, or upon powering up (if **AutoRun=Y**), the SBE 21 responds as follows:

If Average=Y	If Average=N
1. Take samples continuously at 4 Hz (every 0.25 seconds) and average the samples taken within each sample interval [SI=],	1. Take 1 sample every sample interval [SI=] seconds,
2. Store averaged data in FLASH memory and transmit averaged data real-time, and	2. Store data in FLASH memory and transmit data real-time, and
3. Write a header to memory, listing logging start date and time, sample interval, and sample number range. A new header is also written after every 10,000 samples. A maximum of 1000 headers can be written.	

The SBE 21 does not enter quiescent (sleep) state between samples.

Average=x

x=Y: Set SBE 21 to **sample continuously at 4 Hz** (every 0.25 seconds) and average samples taken within each sample interval [**SI=**] seconds, store averaged data in memory, and transmit averaged data real-time.

x=N: Set SBE 21 to take **1** sample every sample interval [**SI=**] seconds, store data in memory, and transmit data real-time.

SI=x

x= interval (seconds) between samples or sample averages. Minimum interval 3 seconds, maximum interval 600 seconds.

Example: Set sample interval to 5 seconds (user input in bold).

SI=5

If **Average=Y**: When logging starts, every 5 seconds SBE 21 takes ~20 samples (1 sample every 0.25 seconds), averages data, stores averaged data in FLASH memory, and transmits averaged data real-time.

If **Average=N**: When logging starts, every 5 seconds SBE 21 takes 1 sample, stores data in FLASH memory, and transmits data real-time.

Logging Commands (*continued*)**Notes:**

- **IL** and **SampleNumber=0** have identical effects. Use either command to initialize logging.
- **Do not initialize logging until all data has been uploaded.** These commands do not delete data; they reset the data pointer. **If you accidentally initialize logging before uploading, recover data as follows:**
 1. Set **SampleNumber=a** and **HeaderNumber=b**, where **a** and **b** are your estimate of number of samples and headers in memory.
 2. Upload data. If **a** is more than actual number of samples in memory or **b** is more than actual number of headers in memory, data for non-existent samples/headers will be bad, random data. Review uploaded data file carefully and delete any bad data.
 3. If desired, increase **a** and/or **b** and upload data again, to see if there is additional valid data in memory.

IL

Initialize logging - after all previous data has been uploaded from SBE 21, initialize logging before starting to log again to make entire memory available for recording. **IL** sets sample number (**SampleNumber=**) and header number (**HeaderNumber=**) to 0 internally. **Do not send IL until all existing data has been uploaded.** SBE 21 requires verification before it proceeds.

If **AutoRun=Y**: If **IL** is not sent, when power is applied logging resumes, storing data to memory without resetting sample number (does not overwrite recorded data).

If **AutoRun=N**: Overwriting of data is controlled by which command is used to start logging - **GL** (start logging, storing data at beginning of memory) or **RL** (resume logging, storing data without resetting sample number).

Example (user input in bold):

IL

This command will change the scan length and/or initialize logging. Repeat the command to verify

IL

SampleNumber=x

x= sample number for first sample when logging begins. Typically used to recover data if you accidentally initialize logging (using **IL**) before uploading existing data.

HeaderNumber=x

x= header number for first sample when logging begins. Typically used to recover data if you accidentally initialize logging (using **IL** or **SampleNumber=0**) before uploading existing data.

GL

Start logging now. SBE 21 overwrites any recorded data and headers in memory. SBE 21 requires verification before it proceeds. SBE 21 takes first sample 3 seconds after command is verified.

Example (user input in bold):

GL

This command will change the scan length and/or initialize logging. Repeat the command to verify.

GL

(data begins appearing)

Logging Commands (*continued*)

RL Resume logging now. SBE 21 resumes writing data and headers to memory without resetting sample or header number (it does not overwrite recorded data). SBE 21 takes first sample 3 seconds after command is verified.

Example (user input in bold):

RL
(data begins appearing)

Note:

After sending **AutoRun=Y**, you must turn power to the SBE 21 off and then on again to start logging.

AutoRun=x

x=Y: Automatically start logging when power is applied. When power is applied, SBE 21 resumes writing data and headers to memory without resetting sample number or header number (does not overwrite recorded data).

x= N: Do not automatically start logging when power is applied.

QL

Stop logging. Press Enter key before sending **QL**.

Notes:

- You may need to send **QL** several times to get the SBE 21 to respond. If the SBE 21 does not appear to respond to **QL**, press Ctrl Z several times, and then try **QL** again.
- If **AutoRun=Y**, remove power to stop logging.
- You must stop logging before uploading data.

Example (user input in bold):

QL
logging stopped, stop command

Data Upload Commands

Stop logging before uploading data.

Notes:

- To save data to a file, click Capture on the Toolbar before entering **DD** or **DH**.
- See *Data Formats* after these *Command Descriptions*.
- **To upload data in a form that can be used by SBE Data Processing:**
 1. Set the output format to SBE 21 using **F1** before uploading.
 2. Use Upload on the Toolbar or Upload Data in the Data menu. Manually entering **DDb,e** does not produce data with the required header information for processing by SBE Data Processing.

DDb,e

Upload data in raw Hex form from scan **b** to scan **e**. If **b** and **e** are omitted, all data is uploaded. First sample is number 1.

Example: Upload samples 0 through 199 to a file (user input in bold):
(Click Capture on Toolbar and enter desired filename in dialog box.)
DD0,199

DH

Upload all headers. First header is 1. New header was written when logging started or resumed and every 10,000 samples thereafter. Header includes:

- header number
- month, day, year, hour, minute, and second when header was written
- first and last sample for header
- interval between samples (**SI=**)
- reason logging stopped
 - stop cmd – sent **QL** to stop,
 - no ext pwr – external power below 7.5 volt cutoff

Example: Upload headers to a file (user input in bold).
(Click Capture on Toolbar and enter desired filename in dialog box.)

DH

```
hdr 1 10 Jul 2009 12:30:33 samples 0 to 4, int = 60 sec, stop = stop cmd
hdr 2 10 Jul 2009 13:02:12 samples 5 to 10, int = 60 sec, stop = stop cmd
```

Sampling Commands

These commands request a single sample. The SBE 21 always stores data for the most recent sample in its buffer.

SS

Output last sample from buffer (sample obtained with **TS**, or latest sample from logging).

TS

Sample for 1 second at 4 Hz (take 4 samples), average data, store averaged data in buffer, and output averaged data.
Data is not stored in FLASH memory.

Note:

The SBE 21 has a buffer that stores the most recent data samples. Unlike data in the FLASH memory, data in the buffer is erased upon removal or failure of power.

Diagnostic Commands

The SBE 21 outputs 100 samples for each diagnostic test. Data is not stored in FLASH memory. Press the Esc key or Stop button to stop the test.

FR

Display frequencies:

Column	Output
1	Raw temperature A/D counts
2	Raw conductivity frequency
3	Temperature frequency converted to match older SBE 21 (firmware version < 4.0)
4	Conductivity frequency converted to match older SBE 21 (firmware version < 4.0)

VR

Display voltages with offset and scale factors applied.

Column	Output
1	External (auxiliary sensor) voltage 0
2	External (auxiliary sensor) voltage 1
3	External (auxiliary sensor) voltage 2
4	External (auxiliary sensor) voltage 3
5	External power voltage / 11
6	Back-up lithium battery voltage / 3.741
7	Operating current / 333.33

T38

Display output from SBE 38 remote temperature sensor.

Calibration Coefficients Commands

Notes:

- Calibration coefficients for the conductivity and primary temperature sensor, and for any auxiliary voltage sensors, are stored in the SBE 21's configuration (.xmlcon or .con) file. View and/or modify the calibration coefficients using the Configure menu in SBE Data Processing or Seasave (see *Checking SBE 21 Configuration (.xmlcon or .con) File in Seasave*).
- If using an SBE 38 remote temperature sensor (**SBE38=Y**), its calibration coefficients are not stored in the SBE 21 EEPROM or in the SBE 21's configuration (.xmlcon or .con) file. View and/or modify the instrument's calibration coefficients by connecting the instrument to the computer directly and using SEATERM.

The following commands set voltage channel offsets and slopes **at the factory**. These are properties of the SBE 21's electronics, and are not calibration coefficients for the auxiliary sensors. These commands are included here for completeness, **but should never be used by the customer**.

VOffset0=**VSlope0=****VOffset1=****VSlope1=****VOffset2=****VSlope2=****VOffset3=****VSlope3=****VOffset4=****VSlope4=****VOffset5=****VSlope5=**

Hardware Configuration Commands

The following commands are used to set manufacturing date, PCB serial numbers, PCB assembly numbers, and auxiliary channel sensor types (description such as *oxygen*, *fluorometer*, etc.) and serial number.

Factory Settings – do not modify in the field

SetMfgDate=
SetPcbSerialNum1=
SetPcbSerialNum2=
SetPcbSerialNum3=
SetPcbSerialNum4=
SetPcbAssembly1=
SetPcbAssembly2=
SetPcbAssembly3=
SetPcbAssembly4=

Auxiliary Sensor Settings – can be modified in the field to accommodate changes in auxiliary sensors cabled to the SBE 21

SetVoltType0=
SetVoltSN0=
SetVoltType1=
SetVoltSN1=
SetVoltType2=
SetVoltSN2=
SetVoltType3=
SetVoltSN3=

Checking SBE 21 Configuration (.xmlcon or .con) File in Seasave

Notes:

- Seasave and SBE Data Processing versions 7.20 introduced .xmlcon files (in XML format). Versions 7.20 and later allow you to open a .con or .xmlcon file, and to save it to a .con or .xmlcon file. Seasave and SBE Data Processing use the same file.
- A new or recalibrated instrument ships with a configuration file that reflects the current configuration as *we know it*. The file is named with the instrument serial number, followed by a .con extension. For example, for an instrument with serial number 2375, Sea-Bird names the file *2375.con*. You may rename the file (but not the extension) if desired; this will not affect the results.
- See *Notes on SBE 38 Remote Temperature Data Format* for details on how the software handles SBE 38 data.

Seasave, our real-time data acquisition and display program, requires a configuration file, which defines the instrument - auxiliary sensors integrated with the instrument, and channels, serial numbers, and calibration dates and coefficients for all the integrated sensors (conductivity and temperature as well as auxiliary sensors). Seasave (as well as our data processing software) uses the information in the configuration file to interpret and process the raw data.

If the configuration file does not match the actual instrument configuration, the software will not be able to interpret and process the data correctly.

The configuration file must indicate if NMEA position and depth data are being added to the SBE 21 data by the Interface Box or the computer running Seasave. The configuration file setup overrides the mode selection in the Interface Box (the Interface Box can be set to echo characters to and from the SBE 21, to add Lat/Lon data to the SBE 21's hex data, or to transmit Lat/Lon data only). In other words, real-time transmission of NMEA data while acquiring data in Seasave is dependent only on the configuration file setting. To verify the contents of the .xmlcon or .con file:

1. Double click on Seasave.exe.
2. Click Configure Inputs. On the Instrument Configuration tab, click *Open*. In the dialog box, select the .xmlcon or .con file and click Open.

3. The configuration information appears on the Instrument Configuration tab. Verify: sensors match those on your SBE 21, auxiliary sensors are assigned to the correct voltage channels, calibration coefficients for all sensors are up-to-date, *NMEA position data added* is selected if using a NMEA navigation device, and other NMEA selections match your system setup. Click **Modify** to bring up a dialog box (shown below) to change the configuration and/or to view / modify calibration coefficients.

Channel/Sensor table reflects this choice. Must agree with SBE 21 setup for **SV=** (0, 1, 2, 3, or 4); see reply from **DS**. Voltage channel 0 in .xmlcon or .con file corresponds to sensor wired to channel 0 on end cap connector, voltage channel 1 in file corresponds to sensor wired to channel 1 on end cap connector, etc.

NMEA - Select if NMEA navigation device used, and select whether NMEA device is connected directly to Deck Unit (interface box) or to computer. You can also append NMEA depth data (3 bytes) and NMEA time data (4 bytes) after Lat/Lon data. Seasave adds current latitude, longitude, and universal time code to data header; appends NMEA data to every scan; and writes NMEA data to .nav file every time Ctrl F7 is pressed or Add to .nav File is clicked. Note: NMEA time can only be appended if NMEA device connected directly to computer.

Configuration for the SBE 21 Seacat

Configuration file opened: None

Remote temperature: SBE 38

External voltage channels: 1

Sample interval seconds: 5

NMEA position data added NMEA depth data added

NMEA device connected to deck unit NMEA time added

NMEA device connected to PC

Scan time added

Select to have Seasave append time (seconds since January 1, 1970 GMT) to each data scan.

Channel	Sensor
1. Frequency	Temperature
2. Frequency	Conductivity
3. Serial RS-232	Temperature, SBE 38
4. A/D voltage 0	pH

Buttons: New, Open..., Save, Save As..., Select..., Modify..., Report..., Help..., Exit, Cancel

Channel/Sensor table reflects this choice (shows RS-232 channel if SBE 38 selected). Must agree with SBE 21 setup (**SBE38=**); see reply from **DS**. If remote temperature is selected, Seasave and SBE Data Processing use remote temperature data when calculating density and sound velocity. Note: Firmware version 5.0 and later of SBE 21 supports only SBE 38 as remote temperature sensor (SBE 3 not supported).

Time between scans. Used to calculate elapsed time, if you select time as an output parameter. Must agree with SBE 21 setup (**SI=**); see reply from **DS**.

Shaded sensors cannot be removed or changed to another type of sensor. All others are optional.

Click a (non-shaded) sensor and click **Select** to pick a different sensor for that channel. A dialog box with a list of sensors appears. Select sensors after number of voltage and frequency channels have been specified above.

New to create new .xmlcon or .con file for this CTD. **Open** to select different .xmlcon or .con file. **Save** or **Save As** to save current .xmlcon or .con file settings.

Click a sensor and click **Modify** to change calibration coefficients for that sensor.

4. Click *Save* or *Save As* to save any changes to the .xmlcon or .con file. Click *Exit* when done reviewing / modifying the configuration.

Data Formats

The SBE 21 outputs data in raw, hexadecimal form as described below.

The inclusion of some output parameters is dependent on the system configuration - if the specified sensor is not enabled (see *Command Descriptions* above), the corresponding data is not included in the output data stream, shortening the data string.

Note:

SBE 21 always outputs an even number of voltage characters. If you enable 1 or 3 voltages, it adds a 0 to the data stream before the last voltage, as shown below:

- Remote temperature and 1 voltage enabled -
ttttcccrrrrrr0uuu or
#ttttcccrrrrrr0uuunnnn
- Remote temperature and 3 voltages enabled -
ttttcccrrrrrruuvvv0www
#ttttcccrrrrrruuvvv0wwwnnnn

- SBE 21 Format (**F1**) - ttttcccrrrrrruuvvvwwwxxx (use this format if you will be using Seasave to acquire real-time data and/or SBE Data Processing to process the data)
- SBE 16 Format (**F2**) - #ttttcccrrrrrruuvvvwwwxxxnnnn (custom format)

where

tttt = primary temperature

cccc = conductivity

rrrrrr = remote temperature (from SBE 38 remote sensor)

uuu, vvv, www, xxx = voltage outputs 0, 1, 2, and 3 respectively

= attention character

nnnn = lineal sample count (0, 1, 2, etc.)

Data is output in the order listed, with no spaces or commas between parameters. Shown with each parameter is the number of digits.

Calculation of the parameter from the data is described below (use the decimal equivalent of the hex data in the equations).

1. Temperature
temperature frequency (Hz) = (tttt / 19) + 2100
2. Conductivity
conductivity frequency (Hz) = square root [(cccc * 2100) + 6250000]
3. SBE 38 secondary temperature (if **SBE38=Y**)
SBE 38 temperature *psuedo* frequency (Hz) = rrrrrr / 256
4. External voltage 0 (if 1 or more external voltages defined with **SV=x**)
external voltage 0 (volts) = uuu / 819
5. External voltage 1 (if 2 or more external voltages defined with **SV=x**)
external voltage 1 (volts) = vvv / 819
6. External voltage 2 (if 3 or more external voltages defined with **SV=x**)
external voltage 2 (volts) = www / 819
7. External voltage 3 (if 4 external voltages defined with **SV=x**)
external voltage 3 (volts) = xxx / 819

Notes:

- Sea-Bird's software (Seasave and SBE Data Processing) uses the equations shown to perform these calculations; it then uses the calibration coefficients in the configuration (.xmlcon or .con) file to convert the raw frequencies and voltages to engineering units. Alternatively, you can use the equations to develop your own processing software.
- See *Notes on SBE 38 Remote Temperature Data Format* below for details on how Sea-Bird handles SBE 38 data.

Example: SBE 21 with SBE 38 and two external voltages sampled, example scan = ttttcccrrrrrruuvvv = A80603DA1B58001F5A21

- Temperature = tttt = A806 (43014 decimal);
temperature frequency = (43014 / 19) + 2100 = 4363.89 Hz
- Conductivity = cccc = 03DA (986 decimal);
conductivity frequency =
square root [986 * 2100 + 6250000] = 2884.545 Hz
- SBE 38 = rrrrrr = 1B5800 (1,792,000 decimal)
temperature *psuedo* frequency (Hz) = (1,792,000 / 256) = 7000 Hz
- First external voltage = uuu = 1F5 (501 decimal);
voltage = 501 / 819 = 0.612 volts
- Second external voltage = vvv = A21 (2593 decimal);
voltage = 2593 / 819 = 3.166 volts

Notes on SBE 38 Remote Temperature Data Format

The SBE 21 was originally designed to interface with an SBE 3 remote temperature sensor. The SBE 3 outputs temperature frequency (Hz), which was appended to the data stream output by the SBE 21. Our software (Seasave and SBE Data Processing) was designed to apply SBE 3 calibration coefficients to the frequency output, to obtain temperature in °C (ITS-90). The equation used by the software to calculate temperature from the SBE 3 data is:

$$\text{Temperature (}^\circ\text{C, ITS-90)} = 1/\{G + H[\ln(F0/F)] + I[\ln^2(F0/F)] + J[\ln^3(F0/F)]\} - 273.15$$

where

G, H, I, J, and F0 are SBE 3 calibration coefficients

F is frequency output from the SBE 3

A number of years ago, Sea-Bird began using the SBE 38 as the standard remote temperature sensor for the SBE 21 thermosalinograph. The SBE 38 is an RS-232 sensor. It applies its internal calibration coefficients to the raw measurements, and outputs temperature in °C (ITS-90). **To maintain compatibility with the existing software algorithms, the SBE 21 internally converts temperature from the SBE 38 [°C (ITS-90)] into a pseudo frequency (Hz).** The *pseudo frequency* is appended to the data stream output by the SBE 21. Our software (Seasave and SBE Data Processing) then applies the SBE 3 calibration equation to the *pseudo frequency* output, to obtain temperature in °C (ITS-90). The coefficients used to generate the *pseudo frequency* for the SBE 38 in the SBE 21, and then to decode the *pseudo frequency* in our software, are constant:

$$G = 4.0\text{e-}3 \quad H = 2.0\text{e-}4 \quad I = 0.0 \quad J = 0.0 \quad F0 = 1000.0$$

When the SBE 38 is selected as the external temperature sensor for the SBE 21 in Seasave or SBE Data Processing, the software automatically enters these G, H, I, J, and F0 coefficients in the .xmlcon or .con file. The software calculates temperature from the *pseudo frequency* with the standard SBE 3 calibration equation and the above calibration coefficients.

Note:

Support for the SBE 38 as the remote temperature sensor for the SBE 21 was added to Seasave and SBE Data Processing in version 5.28a, released in March 2003.

Example: SBE 21 with SBE 38.

SBE 38 outputs 3.7956 °C to SBE 21, and SBE 21 converts this to a *pseudo frequency* using the equation:

$$\text{Temperature (}^\circ\text{C, ITS-90)} = 1/\{G + H[\ln(F0/F)] + I[\ln^2(F0/F)] + J[\ln^3(F0/F)]\} - 273.15 \text{ (}^\circ\text{C)}$$

where G = 4.0e-3, H = 2.0e-4, I = 0.0, J = 0.0, F0 = 1000.0

$$\text{Substituting into the equation: } 3.7956 = 1/\{4.0\text{e-}3 + 2.0\text{e-}4 [\ln(1000/F)]\} - 273.15 \text{ (}^\circ\text{C)}$$

Solving for F, F = 7000 Hz

SBE 21 multiplies this by 256 for appending to the data stream: 7000 x 256 = 1,792,000 decimal = 1B5800 Hex

Looking at output scan from SBE 21 = ttttccccrrrrrr = A80603DA1B5800

SBE 38 = rrrrrr = 1B5800 (1,792,000 decimal)

Using the data output equations from the previous page:

$$\text{temperature } pseudo \text{ frequency (Hz)} = (1,792,000 / 256) = 7000 \text{ Hz}$$

Sea-Bird software applies SBE 3 calibration equation to SBE 38 *pseudo frequency* output:

Temperature (°C, ITS-90) calculated by Sea-Bird software

$$= 1/\{G + H[\ln(F0/F)] + I[\ln^2(F0/F)] + J[\ln^3(F0/F)]\} - 273.15 \text{ (}^\circ\text{C)}$$

where G = 4.0e-3, H = 2.0e-4, I = 0.0, J = 0.0, F0 = 1000.0

$$\text{Temperature (}^\circ\text{C, ITS-90) calculated by Sea-Bird software} = 1/\{4.0\text{e-}3 + 2.0\text{e-}4 [\ln(1000/7000)]\} - 273.15 \text{ (}^\circ\text{C)}$$

$$= 3.7956 \text{ }^\circ\text{C} = \text{temperature directly output from SBE 38}$$

Section 5: Setting Up NMEA Interface

The PN 90488 SEACAT/SEALOGGER RS-232 and Navigation Interface Box includes a NMEA 0183 Interface that permits NMEA data (latitude and longitude, and depth) to be merged with SBE 21 data. The Interface Box decodes messages that are output from devices supporting NMEA 0183 protocol, transmitting at 4800 or 9600 baud, 8 data bits, no parity, and 1 stop bit. **A complete description of the Interface Box - specifications, setup, troubleshooting, data format, and NMEA simulation programs - is provided in a separate manual.** However, setup information is repeated in this section for ease-of-use.

Decoded NMEA data can be appended to the end of the SBE 21 data stream in the Interface Box and passed to the computer for storage and/or display. NMEA data format is detailed in the Interface Box manual. The Interface Box's Yellow *TX NMEA* LED flashes each time a NMEA message is received (should be the same rate at which the NMEA device is transmitting). The Interface Box appends the same NMEA message until a new message is decoded.

- *Example:* A device outputs its NMEA message once every 5 seconds. The Yellow *TX NMEA* LED flashes every 5 seconds, and the same message is appended to each scan of SBE 21 data within that 5 seconds.

NMEA Operating Modes

The Interface Box has three operating modes and two diagnostic modes, as well as two NMEA depth options, and selections for setting and displaying communication parameters and start-up behavior. Mode is selected in the setup menu while communicating with the Interface Box with SEATERM (see *Setting Up and Testing NMEA* below).

Notes:

- In SEATERM, use the @ character to access and exit the setup menu.
- To enter diagnostic modes (8 and/or 9), first put the Interface Box in Mode 3. Then, enter an 8 or 9 at the mode selection prompt.
- To exit diagnostic modes (8 and/or 9), turn off power to the Interface Box.

Type	Mode	Description
Operating	1: Echo only	Characters to and from SBE 21 pass through Interface Box. No NMEA data is sent. Useful for setting up SBE 21.
	2: Add Lat/Lon to hex data	Seven bytes of hex latitude/longitude data is added to each line of hex data from SBE 21. Used when position data is required with SBE 21 data.
	3: Transmit Lat/Lon only	Data from SBE 21 is not transmitted. Hex latitude/longitude data is converted to ASCII text whenever a new position is received from NMEA device. Format is: LAT 47 37.51 N LON 122 09.41 W If NMEA message RMC is decoded, date and time display on next line. Format is: DDMMYY HHMMSS
NMEA Depth Options	4. Add NMEA Depth to real-time Hex/Lat/Lon data	Three bytes of depth data (for example, from a NMEA echo sounder) is added to each line of hex data from SBE 21, after lat/lon data.
	5. Do not add NMEA Depth to real-time Hex/Lat/Lon data	NMEA depth data is not added.
Communication Settings and Start Modes	6. Change communication settings and start mode	Set/reset baud rates, data bits, and parity, NMEA baud rate, and start mode (whether Interface Box starts in Operating Mode 1 or 2 when power applied).
	7. Display communication settings and start mode	Display settings set up in Mode 6.
Diagnostic	8 (diagnostic level 1): Transmit raw NMEA message only	All NMEA messages received are echoed to computer in raw form.
	9 (diagnostic level 2): Transmit decoded NMEA message	All NMEA messages received are decoded by Interface Box and displayed on computer. If you select mode 8 and then select mode 9, the Interface Box transmits raw data followed by decoded data.

Setting Up and Testing NMEA

Note:

The Interface Box must be connected to the SBE 21 to test the NMEA interface. If it is not connected, noise on the open SEACAT Data I/O connector may interfere with communication with the Interface Box.

After connecting the NMEA device, Interface Box, computer, and SBE 21, run SEATERM.

1. Follow Steps 1 through 4 in *Power and Communications Test and SBE 21 Setup in SEATERM in Section 4: Setting Up SBE 21*.
2. Turn on power to the Interface Box. The display looks like this:

```
Interface box V 3.1b setup:
PC baud rate = 9600
SEACAT baud rate = 4800
7 data bits, even parity
NMEA baud rate = 4800
start mode = echo characters to and from the instrument
NMEA message to decode = GGA, GLL, RMA, RMC, TRF, DBT, DPT
Press @ to change the interface box setup
```

3. Type @ to access the setup menu. The display looks like this:

```
Interface Box set up menu:
```

```
Modes:
```

1. Echo characters to and from the instrument
2. Add Lat/Lon to the real-time HEX data from the instrument
3. Transmit Lat/Lon only

```
Options:
```

4. Add NMEA Depth to the real-time HEX/Lat/Lon data
5. Do not add NMEA Depth to the real-time HEX/Lat/Lon data

```
Communications:
```

6. Change communication settings and start mode
7. Display communication settings and start mode

```
Diagnostics:
```

8. enable diagnostic level 1
9. enable diagnostic level 2

```
the current mode = 1. Echo characters to and from the instrument
```

```
enter 1, 2, 3, 4, 5, 6, 7, 8, or 9 followed by Enter, or press @ to exit the set up menu
```

```
selection =
```

Note:

If you select option 4 (you have a NMEA depth device as well as a NMEA position device), the mode 2 description changes to:

2. Add Lat/Lon/**Depth** to the real-time HEX data from the instrument

Notes:

- The NMEA baud rate is limited to 4800 or 9600.
- See the Interface Box manual for changing any communications settings other than the NMEA baud rate.

4. If the NMEA baud rate in the message in Step 2 does not match your NMEA device, type 6 and press the Enter key to change communications settings. The display looks like this:

```
PC baud rate = X, new value = (enter desired value, press Enter)
SEACAT baud rate = X, new value = (enter desired value, press Enter)
parity = X, new value = even parity or no parity [e/n] (enter e or n, press Enter)
NMEA baud rate = X, new value = (enter desired value, press Enter)
Start mode = X, new value = echo or add Lat/Lon [e/a] (enter e or a, press Enter)
```

The display then shows your new selections. Type @ to return to the setup menu.

5. Type 3 and press the Enter key to switch to mode 3. The display looks like this:

```
Interface Box set up menu:
```

```
Modes:
```

1. Echo characters to and from the instrument
2. Add Lat/Lon to the real-time HEX data from the instrument
3. Transmit Lat/Lon only

```
Options:
```

4. Add NMEA Depth to the real-time HEX/Lat/Lon data
5. Do not add NMEA Depth to the real-time HEX/Lat/Lon data

```
Communications:
```

6. Change communication settings and start mode
7. Display communication settings and start mode

```
Diagnostics:
```

8. enable diagnostic level 1
9. enable diagnostic level 2

```
the current mode = 3. Transmit Lat/Lon only
```

```
enter 1, 2, 3, 4, 5, 6, 7, 8, or 9 followed by Enter, or press @ to exit the set up menu
```

```
selection =
```

6. Type @ to exit the menu. You should begin seeing position data display in SEATERM. Each time position data is received, the yellow *TX NMEA* LED on the Interface Box should flash. If the data is correct and is updating properly, the Interface Box is working.

- If position data does not appear, verify that the Interface Box is connected to the NMEA device and that the proper cable is used.
- See the Interface Box manual for troubleshooting instructions if needed.

7. Turn off power to the Interface Box.

Troubleshooting NMEA Interface

See the Interface Box manual for troubleshooting.

Setting Up SBE 21 Configuration (.xmlcon or .con) File

Note:

A new or recalibrated instrument ships with a configuration file that reflects the current configuration as *we know it*. The file is named with the instrument serial number, followed by a .con extension. For example, for an instrument with serial number 2375, Sea-Bird names the file *2375.con*. You may rename the file (but not the extension) if desired; this will not affect the results

The Interface Box integrates the data from the NMEA device into the SBE 21 data stream. Seasave, Sea-Bird's real-time data acquisition and display program, stores and optionally displays the NMEA data along with the thermosalinograph data. Seasave requires a .xmlcon or .con file, which defines the SBE 21 - auxiliary sensors integrated with the instrument, and channels, serial numbers, and calibration dates and coefficients for all the integrated sensors (conductivity and temperature as well as auxiliary sensors). Seasave (as well as our data processing software) uses the information in the configuration file to interpret and process the raw data. If the configuration file does not match the actual instrument configuration, the software will not be able to interpret and process the data correctly.

The configuration file must indicate if NMEA data is being added to the SBE 21 data by the Interface Box or the computer. See *Section 4: Setting Up SBE 21* for details on viewing and modifying the configuration file in Seasave. The configuration file setup overrides the mode selection in the Interface Box (the Interface Box can be set to echo characters to and from the SBE 21, to add Lat/Lon data to the SBE 21's hex data, or to transmit Lat/Lon data only). In other words, real-time transmission of NMEA data is dependent only on the .xmlcon or .con file setting in Seasave.

Section 6: Operating System

This section covers:

- Acquiring real-time data with Seasave
- Uploading SBE 21 data from memory
- Processing data

Acquiring Real-Time Data with Seasave

1. Turn on power to the Interface Box.
 - If **AutoRun=Y** (SBE 21 set up to start logging automatically when internal memory. Note that the data will not appear in Seasave until you tell Seasave to start real-time data acquisition below.
 - If **AutoRun=N** (SBE 21 not set up to start logging automatically when power turned on): Run SEATERM and send **GL** or **RL** to start logging, then close SEATERM (see *Section 4: Setting Up SBE 21*).
2. Double click on **Seasave.exe**.
3. Perform any desired setup in the Configure Inputs, Configure Outputs, and Display menus.

Note:

The baud rate between the Interface Box and computer (defined in Configure Inputs, on the CTD Serial Port tab) must agree with the Interface Box setup (1200, 2400, 4800, 9600, 19200, or 38400 – factory set to 9600).

4. In the Real-Time Data menu, select *Start*. The dialog box looks like this:

Data Archiving Options:

- **Begin archiving data immediately** to store raw (frequencies, A/D counts, and/or voltages) real-time data as soon as Start button is clicked and communication is established.
- **Begin archiving data when 'Start Archiving' command is sent** to control when data begins to be written to file. If you make this selection, when you click Start button and communication is established, a dialog box with Start Archiving button appears. Click this button when ready to begin saving scans to file, or select Start Archiving in Real-Time Data menu.
- **Do not archive data for this cast** to not save data to a file. Real-time data will still appear in displays.

Configuration Options: Currently selected instrument configuration (.xmlcon or .con) file is shown, containing information on number and type of sensors interfacing with SBE 21, calibration coefficients, and inclusion of NMEA data with output from SBE 21. To modify input configuration (.xmlcon or .con file, serial ports, TCP/IP ports, and/or miscellaneous), click Configure Inputs. To modify outputs (serial data output, serial ports, shared file output, mark variables, TCP/IP output, TCP/IP ports, SBE 14 remote display, PC alarms, header form, and/or diagnostics), click Configure Outputs.

- **Timeout in seconds at startup:** Time allowed before first data scan is received from SBE 21. Seasave will *time out* and stop attempting to acquire data if data is not received from SBE 21 within this time period.
- **Timeout in seconds between scans:** Maximum *gap* allowed between scans after first data scan is received from SBE 21. Seasave will *time out* and stop attempting to acquire data if data is not received from SBE 21 within this time period (for example, if a problem with power to the SBE 21 interrupts data acquisition, Seasave stops attempting to acquire data after this gap).

Data Archiving Options

- Begin archiving data immediately
- Begin archiving data when 'Start Archiving' command is sent
- Do not archive data for this cast

Output data [HEX] file
C:\Documents and Settings\dbresko\My Documents\19plustest.hex

Select Output Data File Name

Configuration Options

Instrument configuration [.xmlcon or .con] file: (to change select Configure Inputs)

C:\21.con

Configure Inputs Configure Outputs

Timeout in seconds at startup: 60

Timeout in seconds between scans: 20

Reset deck unit to state 1 when acquisition stops

Report Help Start Exit Cancel

Click **Select Output Data File Name**. Save Archived Data As dialog box appears; browse to desired file location, enter desired file name, and click Save.

Appears only if .xmlcon or .con file indicates that NMEA data is added through deck unit (interface box). If selected, Seasave resets deck unit to State 1 when acquisition stops. State 1 is Echo only mode (no NMEA data is sent), and is useful for setting up SBE 21.

5. In the Start Real-Time Data Acquisition dialog box, click *Start*.
 - A. If you selected *Begin archiving data immediately* or *Begin archiving data when 'Start Archiving' command is sent* above, and selected *Prompt for Header Information* in the Header Form setup (Configure Outputs), the Header Information dialog box appears. Fill in the desired header and click OK.
 - B. If you selected *NMEA position data added* in the .xmlcon or .con file, Seasave initializes NMEA communications. Seasave automatically sends a command(s) to put the Interface Box in Mode 1 (do not transmit NMEA data), Mode 2 (append NMEA position data to SBE 21 data), or Mode 2 with Option 4 (append NMEA position data to CTD data, and also append NMEA depth data), depending on the setup of the SBE 21 configuration file.
 - C. If you selected *Check Scan Length* in the Options menu, Seasave checks the .xmlcon or .con file to verify that the scan length defined by the configuration file matches the SBE 21 (i.e., number of sensors and inclusion of NMEA is as defined in the file). If a *Scan length error* appears, verify that:
 - You are using the correct .xmlcon or .con configuration file.
 - The configuration file has been updated as necessary if you added or deleted sensors, added or deleted NMEA, etc.
 - D. Seasave sends a message: *Waiting for data . . .* Seasave will *time out* if data is not received within *Timeout in seconds at startup*.
 - E. Real-time data then starts appearing in the screen display(s).
6. To stop real-time data acquisition: In the Real-Time Data menu, select *Stop*.
7. Close Seasave.
8. Double click on **SeaTerm.exe**.
 - A. Establish communications with the SBE 21 by pressing the Enter key several times.
 - B. Send **QL** to stop logging. You may need to send **QL** several times before the SBE 21 responds.
q1
logging stopped, stop command
 - C. If you want to upload data from the SBE 21's memory now, see *Uploading SBE 21 Data from Memory* below.
 - D. Send **QS** to place the SBE 21 in quiescent (sleep) state.
9. Turn off power to the Interface Box.

Uploading SBE 21 Data from Memory

1. Double click on SeaTerm.exe. The display shows the main screen.
2. In the Configure menu, select *SBE 21*. Click on the Upload Settings tab. The dialog box looks like this:

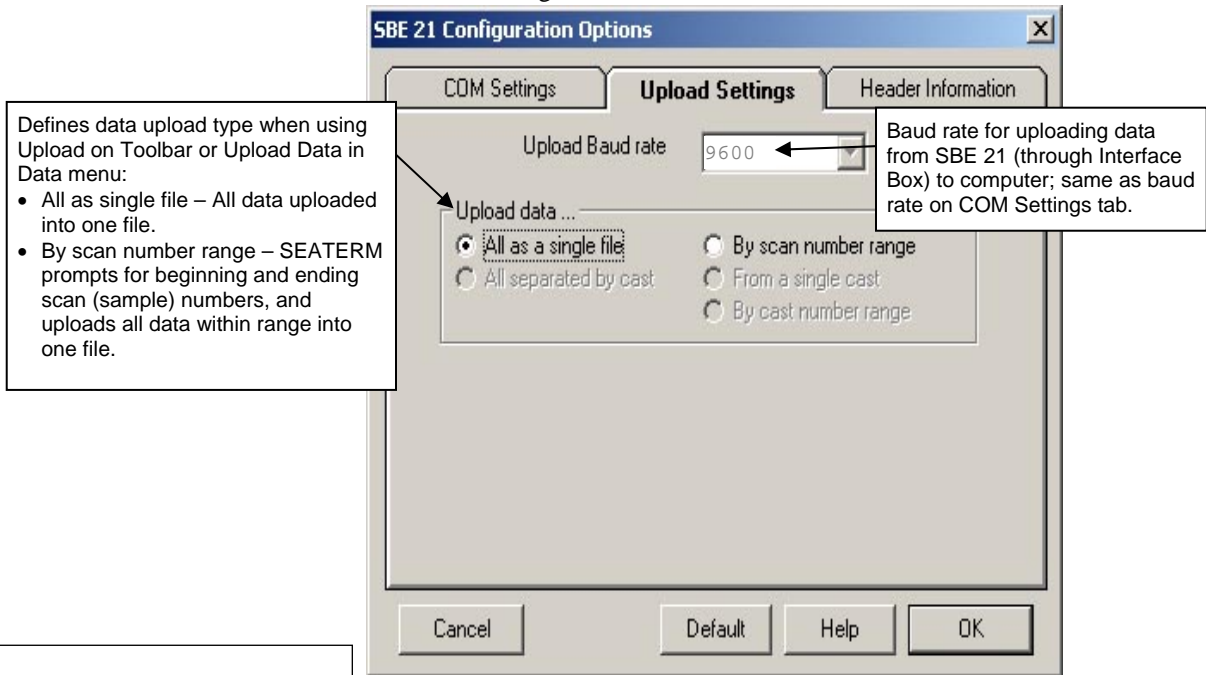

Note:
Set up **Upload Settings**, **Header Information**, and/or **Header Form** (Steps 2 through 4):

- The first time you upload data, and
- If you want to change upload or header parameters.

Make the selection for Upload Settings.

3. Click on the Header Information tab. The dialog box looks like this:

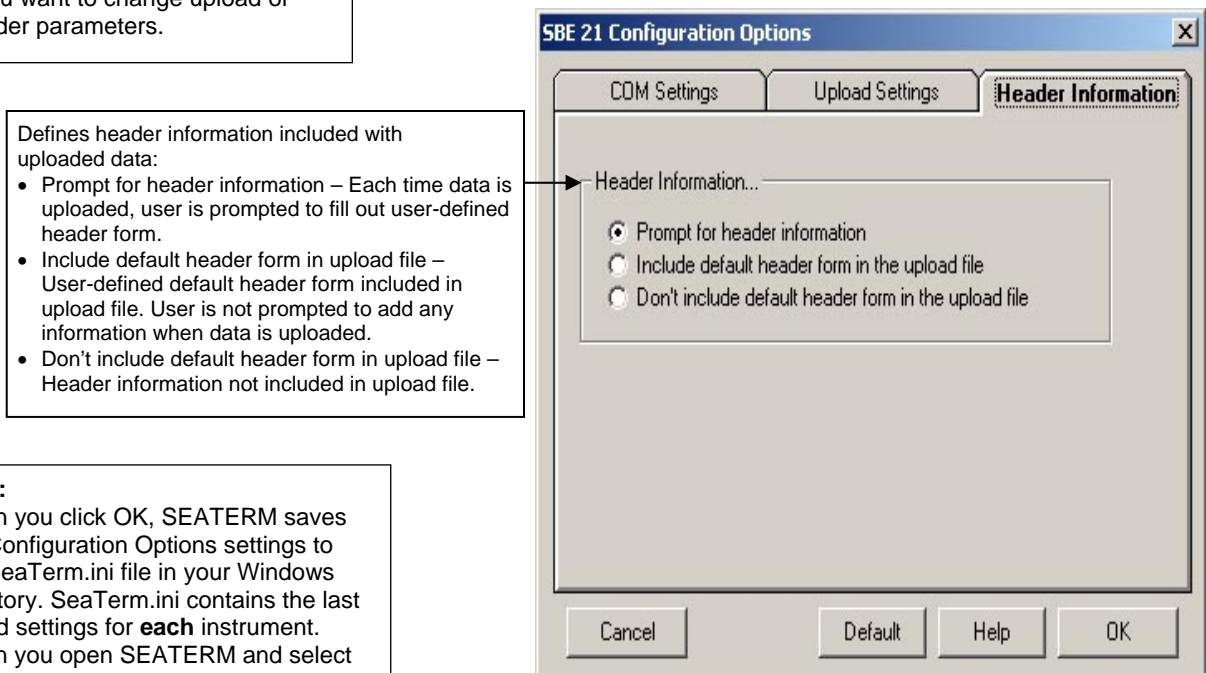

Note:
When you click OK, SEATERM saves the Configuration Options settings to the SeaTerm.ini file in your Windows directory. SeaTerm.ini contains the last saved settings for **each** instrument. When you open SEATERM and select the desired instrument (SBE 19, 21, 25, etc.) in the Configure menu, the Configuration Options dialog box shows the last saved settings for that instrument.

Select the desired header information option. Click OK to save all the settings in the Configuration Options dialog box.

4. In the Configure menu, select Header Form to customize the header. The dialog box looks like this (default prompts are shown):

The entries are free form, 0 to 12 lines long. This dialog box establishes:

- the header prompts that appear for the user to fill in when uploading data, if *Prompt for header information* was selected in the Configuration Options dialog box (Step 3)
- the header included with the uploaded data, if *Include default header form in upload file* was selected in the Configuration Options dialog box (Step 3)

Enter the desired header/header prompts. Click OK.

Notes:

- See *Section 5: Setting Up NMEA Interface* for details on the setup menu.
- If the SBE 21 is set up to automatically start sampling when power is applied (**AutoRun=Y**), the Interface Box setup is followed by hex data output from the SBE 21.

5. Turn on power to the Interface Box. Type @ to access the setup menu. Type I and press the Enter key to echo characters from the SBE 21. Type @ to exit the setup menu.
6. Click Connect on the Toolbar or press the Enter key several times. If you used Connect on the Toolbar, the display looks like this:

```
*ds
SC21, 4300, 5.0a, 50000, 50, 6, N
```

This is a factory-diagnostic status command and reply. The reply indicates instrument serial number [4300], firmware version [5.0a], number of samples in memory [50000], number of headers in memory [50], number of bytes in each scan [6], and whether the SBE 21 is logging [L] or not logging [N].

If the system does not respond:

- Click Connect again or press the Enter key several times.
- Check cabling between the computer, Interface Box, and SBE 21.
- Verify the correct instrument was selected and the COM settings were entered correctly in the Configure menu.

7. Display SBE 21 status information by clicking Status on the Toolbar.

The display looks like this:

```
SEACAT THERMOSALINOGRAPH V5.0a SERIAL NO. 4300 12/15/2009 14:02:13
ioper = 50.7 ma   vmain = 11.4,   vlith = 8.8
samples = 50000, free = 10666357
sample interval = 5 seconds, no. of volts sampled = 0
output format = SBE21
start sampling when power on = no
average data during sample interval = yes
logging data = no
voltage cutoff = 7.5 volts
```

8. If the status reply indicates that the SBE 21 is still logging, command the SBE 21 to stop logging by pressing the Enter key and sending **QL**. You may need to send **QL** several times before the SBE 21 responds.

ql

logging stopped, stop command

9. If *output format = SBE16* in the status display, and you intend to use Sea-Bird data processing software, send **F1** to change the output format to SBE 21. Verify *output format = SBE21* by clicking Status on the Toolbar again.
10. Click Upload on the Toolbar to upload stored data in a form that our data processing software can use. SEATERM responds as follows:
- SEATERM sends the status (**DS**) command, displays the response, and writes the command and response to the upload file. **DS** provides information regarding the number of samples in memory, scan interval, etc.
 - SEATERM sends the header (**DH**) command, displays the response, and writes the command and response to the upload file. **DH** provides information regarding the number of samples in each *cast* (SBE 21 writes a header each time sampling is restarted, as well as every 10,000 scans), date and time the *cast* was started, and sample interval.
 - If you selected *By scan number range in the Configuration Options dialog box (Configure menu)*** – a dialog box requests the range. Enter the desired value(s), and click OK.
 - If you selected *Prompt for header information in the Configuration Options dialog box (Configure menu)*** – a dialog box with the header form appears. Enter the desired header information, and click OK.
 - In the Open dialog box, enter the desired upload file name and click OK. The upload file has a .hex extension.
 - SEATERM sends the data upload (**DDb,e**) command.
11. Ensure all data has been uploaded from the SBE 21 by reviewing and processing the data:
- Use **Seasave** to display the *raw* hexadecimal data from the SBE 21 in engineering units (see Seasave’s manual / Help files).
 - Use **SBE Data Processing** to process and plot the data (see SBE Data Processing’s manual / Help files).

Note:

To prepare the SBE 21 for re-deployment:

- After all data has been uploaded, send **IL**. If **IL** is not sent and logging is started with **RL** or by applying power, new data will be stored after the last recorded sample, preventing use of the entire memory capacity.
- Send **QS** to put the SBE 21 in quiescent (sleep) state until ready to restart logging.
- Turn off power to the Interface Box.

Processing Data

Notes:

- Seasave and SBE Data Processing versions 7.20 introduced .xmlcon files (in XML format). Versions 7.20 and later allow you to open a .con or .xmlcon file, and to save it to a .con or .xmlcon file. Seasave and SBE Data Processing use the same file.
- A new or recalibrated instrument ships with a configuration file that reflects the current configuration as *we know it*. The file is named with the instrument serial number, followed by a .con extension. For example, for an instrument with serial number 2375, Sea-Bird names the file 2375.con. You may rename the file (but not the extension) if desired; this will not affect the results.

Process the data in SBE Data Processing:

1. Convert the .hex (raw data) file (created by Seasave or uploaded from SBE 21 memory) to a .cnv (engineering units) file in SBE Data Processing's Data Conversion module. To convert the .hex file, you need a .xmlcon or .con configuration file, which defines the instrument – integrated sensors, and channels, serial numbers, and calibration dates and coefficients for all sensors (conductivity and temperature as well as auxiliary sensors). SBE Data Processing uses the configuration file information to interpret and process the raw data. The .xmlcon or .con file can be set up in SBE Data Processing or in Seasave - see *Checking SBE 21 Configuration (.xmlcon or .con) File in Seasave* in Section 4: *Setting Up SBE 21* for a description of the entries.
2. Once the data is converted: perform further processing (align, filter, remove bad data, etc.), calculate derived variables, and plot data using SBE Data Processing's other modules.

Editing Raw Data File

Sometimes users want to edit the raw .hex data file before beginning processing, to remove data at the beginning of the file corresponding to instrument *soak* time, to remove blocks of bad data, to edit the header, or to add explanatory notes. **Editing the raw .hex file can corrupt the data, making it impossible to perform further processing using Sea-Bird software.** We strongly recommend that you first convert the data to a .cnv file (using Data Conversion in SBE Data Processing), and then use other SBE Data Processing modules to edit the .cnv file as desired.

The procedure for editing a .hex data file described below has been found to work correctly on computers running Windows 98, 2000, and NT. **If the editing is not performed using this technique, SBE Data Processing may reject the edited data file and give you an error message.**

1. **Make a back-up copy of your .hex data file before you begin.**
2. Run **WordPad**.
3. In the File menu, select Open. In the Open dialog box: for *Files of type*, select *All Documents (*.*)*. Browse to the desired .hex file and click Open.
4. Edit the file as desired, **inserting any new header lines after the System Upload Time line**. Note that all header lines must begin with an asterisk (*), and *END* indicates the end of the header. An example is shown below, with the added lines in bold:

Note:

Although we provide this technique for editing a raw .hex file, **Sea-Bird's strong recommendation, as described above, is to always convert the raw data file and then edit the converted file.**

```
* Sea-Bird SBE 21 Data File:
* FileName = C:\Odis\SAT2-ODIS\oct14-19\oc15_99.hex
* Software Version Seasave Win32 v1.10
* Temperature SN = 2366
* Conductivity SN = 2366
* System UpLoad Time = Oct 15 1999 10:57:19
* Testing adding header lines
* Must start with an asterisk
* Place anywhere between System Upload Time & END of header
* NMEA Latitude = 30 59.70 N
* NMEA Longitude = 081 37.93 W
* NMEA UTC (Time) = Oct 15 1999 10:57:19
* Store Lat/Lon Data = Append to Every Scan and Append to .NAV
File When <Ctrl F7> is Pressed
** Ship:          Sea-Bird
** Cruise:       Sea-Bird Header Test
** Station:
** Latitude:
** Longitude:
*END*
```

5. In the File menu, select Save (**not** Save As). If you are running Windows 2000, the following message displays:
You are about to save the document in a Text-Only format, which will remove all formatting. Are you sure you want to do this?
Ignore the message and click *Yes*.
6. In the File menu, select Exit.

Section 7: Routine Maintenance and Calibration

This section reviews corrosion precautions, removing the sensor / electronics module from the SBE 21 water jacket, conductivity cell cleaning and storage, and sensor calibration. The accuracy of the SBE 21 is sustained by the care and calibration of the sensors and by establishing proper handling practices.

Corrosion Precautions

All hardware exposed to seawater is titanium; the housing is plastic. No corrosion precautions are required. The SBE 21 should be cleaned as described below after use and prior to storage.

Removing Sensor/Electronics Module from SBE 21 Water Jacket

Remove 4 bolts securing square end cap to top plate



Place all 4 valves in vertical (closed) position

Sensor/Electronics Module (anti-foulant device fittings not shown; see detail at right)

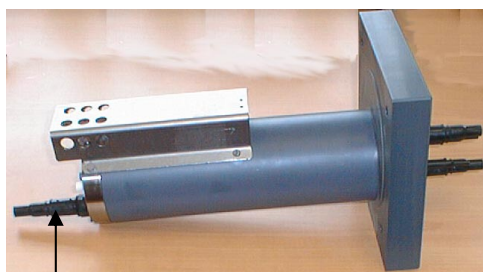

Connector used only for factory calibration and testing

1. **Close all 4 valves (valve is closed when the handle is vertical).**
2. Remove sensor/electronics module from water jacket:
 - A. Remove the 4 bolts, washers, and nuts securing the square end cap to the SBE 21 top plate.
 - B. Lift the square end cap straight up, removing the sensor/electronics module from the water jacket.
 - C. Protect the o-ring on the top plate from damage or contamination.
3. When desired, replace the sensor/electronics module in the water jacket:
 - A. Inspect the top plate o-ring and mating surfaces for dirt, nicks, and cuts. Clean or replace as necessary. Apply a light coat of o-ring lubricant (Parker Super O Lube) to o-ring and mating surfaces.
 - B. Carefully replace the sensor/electronics module in the water jacket, aligning the bolt holes on the square end cap and top plate.
 - C. Reinstall the 4 bolts, washers, and nuts to secure the end cap to the top plate.

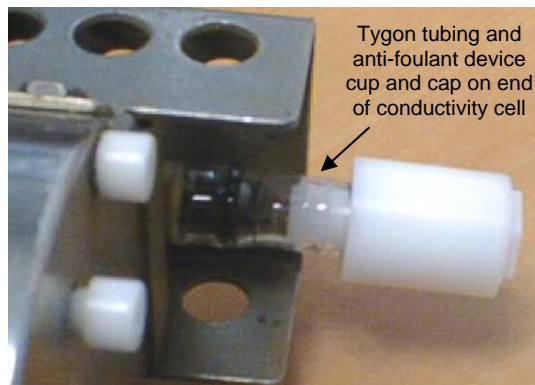

Detail showing anti-foulant device fitting (typical, each end of conductivity cell) – see Appendix IV: AF24173 Anti-Foulant Device for handling details



Alternate detail of Tygon tubing and anti-foulant device cup and cap – Sea-Bird began using black anti-foulant device cup and cap instead of white in 2008

Cleaning and Storage

CAUTION:

The SBE 21's conductivity cell is shipped dry to prevent freezing in shipping. **Do not store the SBE 21 with water in the conductivity cell.** Freezing temperatures (for example, in Arctic environments or during air shipment) can break the cell if it is full of water.

Clean the SBE 21 and conductivity cell:

- Monthly (during sustained use)
- Before periods of non-use – If the cell is not rinsed between usage, salt crystals may form on the platinized electrode surfaces. When the instrument is used next, sensor accuracy may be temporarily affected until these crystals dissolve.
- If the data looks incorrect –
 - Unusually *noisy* data may be caused by debris going through the cell.
 - Unusually *smooth* data may be caused by a blockage in the flow path or in the cell.
 - Shifted data may be caused by fouling inside the cell.

Valves shown in *Normal Use* position
(open = horizontal, closed = vertical)

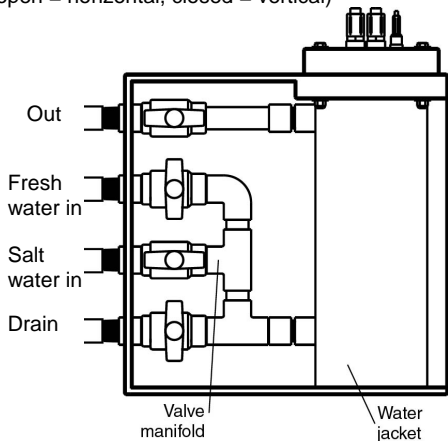

Step 1: Flush with Fresh Water and Drain

- A. Flush the system with fresh water by placing the SBE 21 valves in the following positions:
 - Out** - open
 - Fresh water in** - open
 - Salt water in** - closed
 - Drain** - closed
- B. Place the valves in the following positions and allow the water to drain:
 - Out** - closed
 - Fresh water in** - closed
 - Salt water in** - closed
 - Drain** - open

Step 2: Inspect and Clean Water Jacket

- A. Close all four valves.
- B. Remove the sensor/electronics module from the water jacket (see *Removing Sensor/Electronics Module from SBE 21 Water Jacket*).
- C. Use a flashlight to inspect the inside of the water jacket for debris, fine deposits, or oil film. If this is a routine monthly maintenance, and there is no evidence of debris, fine deposits or oil film, proceed to *Step 4: Reinstall Sensor/Electronics Module*.
- D. Use paper towels to remove any deposits inside the water jacket.

Step 3: Flush Inside of Conductivity Cell

- A. Remove the anti-foulant device fittings from each end of the conductivity cell. See *Appendix IV: AF24173 Anti-Foulant Device* for handling details.
- B. **Refer to Application Note 2D: Instructions for Care and Cleaning of Conductivity Cells for conductivity cell cleaning procedures and cleaning materials.**
 - The Active Use (after each cast) section of the application note is not applicable to the SBE 21.
- C. If the SBE 21 is being stored, remove larger droplets of water by blowing through the conductivity cell. **Do not use compressed air**, which typically contains oil vapor.
- D. Reinstall the anti-foulant device fittings on each end of the conductivity cell. See *Appendix IV: AF24173 Anti-Foulant Device* for handling details.

CAUTIONS:

- **Do not put a brush or any object inside the conductivity cell to clean it or dry it.** Touching and bending the electrodes can change the calibration. Large bends and movement of the electrodes can damage the cell.
- **Do not store the SBE 21 with water in the conductivity cell.** Freezing temperatures (for example, in Arctic environments or during air shipment) can break the cell if it is full of water.

Step 4: Reinstall Sensor/Electronics Module

- A. See *Removing Sensor/Electronics Module from SBE 21 Water Jacket* for details on reinstalling the module.
- B. If you will not be immediately using the SBE 21, leave all the valves in the closed position.
For Normal use, place the valves in these positions:
Out - open
Fresh water in - closed
Salt water in - open
Drain - closed

CAUTION:

To remove the electronics from the housing for troubleshooting, see *Appendix II: Electronics Disassembly/Reassembly*.

If the data still looks incorrect after cleaning, it may be caused by:

- a problem with the electrical connections
- a problem with the PCBs inside the sensor/electronics module housing
- internal fouling in the conductivity cell that was not removed by flushing
- sensors that need to be recalibrated

Sensor Calibration

Note

After recalibration, Sea-Bird ships the instrument back to the user with Calibration Certificates showing the new coefficients. We also ship a new instrument configuration (.con) file, which includes the new coefficients.

Sea-Bird sensors are calibrated by subjecting them to known physical conditions and measuring the sensor responses. Coefficients are then computed which may be used with appropriate algorithms to obtain engineering units. The conductivity and temperature sensors on the SBE 21 are supplied fully calibrated, with coefficients printed on their respective Calibration Certificates (see back of manual).

We recommend that the SBE 21's sensor/electronics module be returned to Sea-Bird for calibration (see *Removing Sensor/Electronics Module from SBE 21* above).

Conductivity Sensor Calibration

The conductivity sensor incorporates a fixed precision resistor in parallel with the cell. When the cell is dry and in air, the sensor's electrical circuitry outputs a frequency representative of the fixed resistor. This frequency is recorded on the Calibration Certificate and should remain stable (within 1 Hz) over time.

The primary mechanism for calibration drift in conductivity sensors is the fouling of the cell by chemical or biological deposits. Fouling changes the cell geometry, resulting in a shift in cell constant.

Accordingly, the most important determinant of long-term sensor accuracy is the cleanliness of the cell. We recommend that the conductivity sensor be calibrated before and after deployment, but particularly when the cell has been exposed to contamination by oil slicks or biological material.

Temperature Sensor Calibration

The primary source of temperature sensor calibration drift is the aging of the thermistor element. Sensor drift will usually be a few thousandths of a degree during the first year, and less in subsequent intervals. Sensor drift is not substantially dependent upon the environmental conditions of use, and — unlike platinum or copper elements — the thermistor is insensitive to shock.

Section 8: Troubleshooting

This section reviews common problems in operating the SBE 21, and provides the most common causes and solutions.

Problem 1: Unable to Communicate with Interface Box

The Interface Box setup message indicates that communications between the Interface Box and computer have been established. Before proceeding, attempt to establish communications again by typing @ several times.

Cause/Solution 1: The I/O cable connection may be loose. Check the cabling between the Interface Box and computer.

Cause/Solution 2: The communication settings entered in SEATERM may not match the setup in the Interface Box. Select the SBE 21 in the Configure menu and verify the settings in the Configuration Options dialog box. If necessary, change communication settings in the Interface Box (see the Interface Box manual for details).

Problem 2: Unable to Communicate with SBE 21

(If **OutputExecutedTag=N**) The S> prompt indicates that communications between the SBE 21 and computer (through the Interface Box) have been established. Before proceeding, attempt to establish communications again by clicking Connect on SEATERM's toolbar or hitting the Enter key several times.

Cause/Solution 1: The I/O cable connection may be loose. Check the cabling between the SBE 21 and Interface Box.

Cause/Solution 2: The instrument type and/or its communication settings may not have been entered correctly in SEATERM. Select the SBE 21 in the Configure menu and verify the settings in the Configuration Options dialog box. The settings should match those on the instrument Configuration Sheet.

Cause/Solution 3: The communication settings entered in SEATERM may not match the settings in the Interface Box. Select the SBE 21 in the Configure menu and verify the settings in the Configuration Options dialog box. If necessary, change communication settings or settings in the Interface Box (see the Interface Box manual for details).

Cause/Solution 4: The I/O cable connecting the SBE 21 to the Interface Box may not be the correct one. Verify the cable is the correct one.

Cause/Solution 5: The SBE 21 may have been set to automatically start sampling when power is applied (**AutoRun=Y**). You may need to send **QL** several times to interrupt sampling.

ql

logging stopped, stop command

You should then be able to communicate.

Problem 3: No Data Recorded

Cause/Solution 1: The SBE 21's memory may be full; once the memory is full, no further data is recorded. Verify that the memory is not full using **DS** (*free = 0 or 1* if memory is full). Sea-Bird recommends that you upload all previous data before beginning another deployment. Once data is uploaded, use **IL** to reset the memory. After the memory is reset, **DS** shows *samples = 0*.

Problem 4: Nonsense or Unreasonable Data

Note:

A new or recalibrated instrument ships with a configuration file that reflects the current configuration as *we know it*. The file is named with the instrument serial number, followed by a .con extension. For example, for an instrument with serial number 2375, Sea-Bird names the file *2375.con*. You may rename the file (but not the extension) if desired; this will not affect the results.

The symptom of this problem is a data file that contains nonsense values (for example, 9999.999) or unreasonable values (for example, values that are outside the expected range of the data).

Cause/Solution 1: A data file with nonsense values may be caused by incorrect instrument configuration in the .xmlcon or .con configuration file (i.e., assignment of sensors to channels in the configuration file does not match the actual installation). Verify the settings in the configuration file match the instrument Configuration Sheet.

Cause/Solution 2: A data file with unreasonable (i.e., out of the expected range) values for temperature, conductivity, etc. may be caused by incorrect calibration coefficients in the instrument .xmlcon or .con configuration file. Verify the calibration coefficients in the configuration file match the instrument Calibration Certificates.

Problem 5: Salinity Lower than Expected

Cause/Solution 1: A fouled conductivity cell will report lower than correct salinity. Large errors in salinity indicate that the cell is extremely dirty, has something large lodged in it, or is broken. Proceed as follows:

1. Clean the conductivity cell (*Cleaning and Storage* in *Section 7: Routine Maintenance and Calibration*).
2. Remove larger droplets of water by blowing through the conductivity cell. **Do not use compressed air**, which typically contains oil vapor.
3. Running the SBE 21 in air, collect some data in Seasave and look at the raw conductivity frequency. It should be within 1 Hz of the zero conductivity value printed on the conductivity cell Calibration Sheet. If it is significantly different, the cell is probably damaged.

Problem 6: Program Corrupted

Note:

Performing a reset affects the SBE 21's memory.

- Download all data in memory before performing the reset.
- After performing the reset, set the date and time (**DateTime=**) and initialize logging (**IL**). Other setup parameters are unaffected.

Cause/Solution 1: In rare cases, a severe static shock or other problem can corrupt the program that controls the SBE 21's microprocessor. This program can be reset by removing the J1 jumper on the Power PCB:

1. Remove the sensor/electronics module from the water jacket (*Section 7: Routine Maintenance and Calibration*), and remove the electronics from the housing (*Appendix II: Electronics Disassembly/Reassembly*).
2. Remove the J1 jumper from the Power PCB (top board in the PCB assembly). This jumper is used to disconnect the back-up lithium battery from the electronics. Leave the jumper off for several minutes.
3. Reinstall the J1 jumper, and reinstall the electronics in the housing.
4. Establish communications with the SBE 21 (*Section 4: Setting Up SBE 21*). Initialize logging with **IL**, and set the date and time with **DateTime=**. Use **DS** to verify that the date and time and sample number are correct.
5. Replace the sensor/electronics module in the water jacket.

Glossary

Fouling – Biological growth in the conductivity cell during deployment.

PCB – Printed Circuit Board.

PN 90488 – SEACAT/SEALOGGER RS-232 and Navigation

Interface Box – Box provides:

- Power and an opto-isolated RS-232C interface for the SBE 21
- Power and an opto-isolated NMEA receiver for a NMEA device (not supplied by Sea-Bird)
- An RS-232C computer interface

SBE Data Processing – Sea-Bird's Win 2000/XP data processing software, which calculates and plots temperature and conductivity, data from auxiliary sensors, and derived variables such as salinity and sound velocity.

Scan – One data sample containing temperature and conductivity, as well as data from auxiliary sensors.

SEACAT – High-accuracy conductivity, temperature, and pressure recorder. The SEACAT is available as the SBE 16*plus* V2 (moored applications), SBE 19*plus* V2 (profiling or moored applications), and SBE 21 (thermosalinograph, no pressure).

Seasave V7 – Sea-Bird's Windows 2000/XP software used to acquire, convert, and display real-time or archived raw data.

SEASOFT V2– Sea-Bird's complete Windows 2000/XP software package, which includes software for communication, real-time data acquisition, and data analysis and display. SEASOFT V2 includes **SEATERM**, **Seasave V7**, **SBE Data Processing**.

SEATERM – Sea-Bird's Win 95/98/NT/2000/XP terminal program used to communicate with the Interface Box and SBE 21. SEATERM can send commands to the SBE 21 (through the Interface Box) to provide status display, data acquisition setup, data display and capture, data upload from memory, and diagnostic tests.

TCXO – Temperature Compensated Crystal Oscillator.

Triton X-100 – Reagent grade non-ionic surfactant (detergent), used for cleaning the conductivity cell. Triton can be ordered from Sea-Bird, but should also be available locally from chemical supply or laboratory products companies. Triton is manufactured by Mallinckrodt Baker (see www.mallbaker.com/changecountry.asp?back=/Default.asp for local distributors)

Super O-Lube – Silicone lubricant used to lubricate O-rings and O-ring mating surfaces. Super O-Lube can be ordered from Sea-Bird, but should also be available locally from distributors. Super O-Lube is manufactured by Parker Hannifin (www.parker.com/ead/cm2.asp?cmid=3956).

Appendix I: Functional Description

Sensors

The SBE 21 embodies the same sensor elements (pressure-protected thermistor and 3-electrode, 2-terminal, borosilicate glass cell) previously used in Sea-Bird's modular SBE 3 and SBE 4 sensors and in the original SEACAT design. The current version of the SBE 21 differs from older versions of the SBE 21 in that it uses two independent channels to digitize temperature and conductivity concurrently. Multiplexing is not used for these channels.

Sensor Interface

Temperature is acquired by applying an AC excitation to a bridge circuit containing an ultra-stable aged thermistor with a drift rate of less than 0.002 °C per year. The other elements in the bridge are VISHAY precision resistors. A 24-bit A/D converter digitizes the output of the bridge. AC excitation and ratiometric comparison avoids errors caused by parasitic thermocouples, offset voltages, leakage currents, and reference errors.

Conductivity is acquired using an ultra-precision Wein-Bridge oscillator to generate a frequency output in response to changes in conductivity.

The four external 0 to 5 volt DC voltage channels are processed by differential amplifiers with an input resistance of 50K ohms and are digitized with a 12-bit A/D converter.

Real-Time Clock

To minimize power and improve clock accuracy, a temperature-compensated crystal oscillator (TCXO) is used as the real-time-clock frequency source. The TCXO is accurate to ± 1 minute per year (0 °C to 40 °C).

Power

The Power PCB contains three series-connected lithium cells (non-hazardous) which are diode OR'd with the external power source. The lithium supply is capable of supporting all SBE 21 functions and serves to permit orderly shutdown in the event of failure or removal of external power. External power can be removed without disturbing memory or the real-time clock.

Appendix II: Electronics Disassembly/Reassembly

Note:

Do not disassemble the SBE 21 electronics to send the sensors or PCBs to Sea-Bird for recalibration or repair. Package the sensor/electronics module for shipment (see *Removing Sensor/Electronics Module from SBE 21 Water Jacket in Section 7: Routine Maintenance and Calibration*).

Do not disassemble the SBE 21 electronics unless you are troubleshooting a problem, and need to access the PCBs.

Sea-Bird provides a jackscrew kit with the SBE 21, to assist in removal of the electronics end cap. The kit contains:

- 2 Allen wrenches
- 3 jackscrews
- 2 spare plastic socket hex-head screws



Jackscrew kit

Disassembly

1. As a precaution, upload any data in memory before beginning. See *Uploading SBE 21 Data from Memory in Section 6: Operating System*.

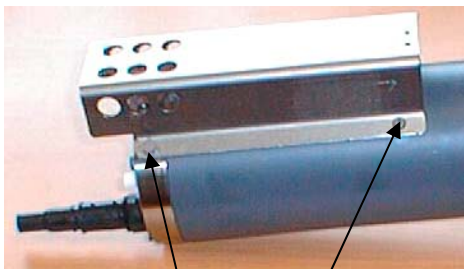

Do not remove socket head screw attaching guard to sensor end cap (2 places)

Remove slotted head screw (2 places)

2. Remove the SBE 21 sensor/electronics module from the water jacket, as described in *Removing Sensor/Electronics Module from SBE 21 Water Jacket in Section 7: Routine Maintenance and Calibration*.

3. Remove the 2 slotted head screws securing the conductivity cell guard to the housing. **Do not remove the 2 screws holding the cell guard to the sensor end cap.**

4. Remove the sensor end cap (with attached conductivity cell and cell guard) and electronics as follows:

- A. Wipe the outside of the sensor end cap and housing dry, being careful to remove any water at the seam between them.
- B. Remove the 4 socket head screws securing the end cap to the housing.
- C. Remove the 3 plastic hex head screws from the end cap using the larger Allen wrench. Insert the three jackscrews in these three holes in the end cap. When you begin to feel resistance, use the smaller Allen wrench to continue turning the screws. Turn each screw 1/2 turn at a time. As you turn the jackscrews, the end cap will push away from the housing.
- D. When the end cap is loosened, carefully slide the end cap and attached electronics out of the housing.
- E. Remove any water from the o-rings and mating surfaces inside the housing with a lint-free cloth or tissue.
- F. Disconnect the Molex connectors connecting the PCB assembly to the housing.
- G. Be careful to protect the o-rings from damage or contamination.

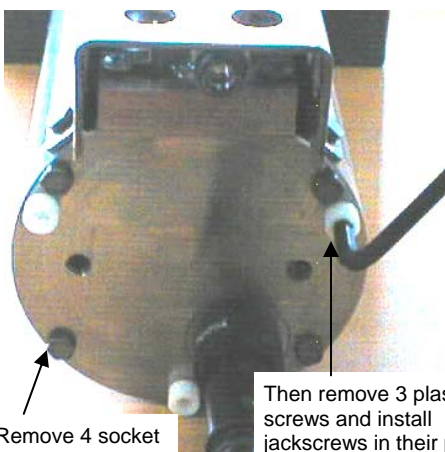

Remove 4 socket head screws

Then remove 3 plastic screws and install jackscrews in their place

CAUTION:

Avoid getting anything on the PCB, which can be damaged by water or other materials.

Reassembly

Note:

Before delivery, a desiccant package is inserted in the housing and the electronics chamber is filled with dry Argon gas. These measures help prevent condensation. To ensure proper functioning:

1. Install a new desiccant bag each time you open the electronics chamber. If a new bag is not available, see *Application Note 71: Desiccant Use and Regeneration (drying)*.
2. If possible, dry gas backfill each time you open the housing. If you cannot, wait at least 24 hours before redeploying, to allow the desiccant to remove any moisture from the housing.

1. Remove any water from the O-rings and mating surfaces with a lint-free cloth or tissue. Inspect the O-rings and mating surfaces for dirt, nicks, and cuts. Clean as necessary. Apply a light coat of O-ring lubricant (Parker Super O Lube) to O-rings and mating surfaces.
2. Reconnect the Molex connectors to the PCB assembly.
3. Carefully fit the PCB assembly into the housing, aligning the holes in the end cap and housing, and the holes in the conductivity cell guard and housing.
4. Reinstall the 4 socket head screws to secure the end cap to the housing.
5. Reinstall the 3 plastic screws in the end cap.
6. Reinstall the 2 slotted screws to secure the conductivity cell guard to the housing.

Appendix III: Command Summary

CATEGORY	COMMAND	DESCRIPTION
Status	GetCD	Get and display configuration data.
	GetSD	Get and display status data.
	GetCC	Get and display calibration coefficients: voltage channel offsets and slopes, and conductivity zero frequency.
	GetEC	Get and display event counters.
	ResetEC	Reset event counters.
	GetHD	Get and display hardware data.
	DS	Display status and setup parameters.
Setup	DateTime=mmddyyhhmmss	Set real-time clock month, day, year, hour, minute, second.
	Baud=x	x= baud rate (600, 1200, 2400, 4800, 9600, 19200, or 38400). Default 4800.
	OutputExecutedTag=x	x=Y: Display XML Executing and Executed tags. x=N: Do not.
	SBE38=x	x=Y: Enable SBE 38 remote temperature sensor. x=N: Do not.
	SV=x	x=0, 1, 2, 3, or 4: Enable 0, 1, 2, 3, or 4 external voltages.
	Fx	x=1: output raw data in SBE 21 format (required for Seasave and/or SBE Data Processing). x=2: output raw data in SBE 16 format (custom).
	QS	Enter quiescent (sleep) state.
Logging	Average=x	x=Y: Set SBE 21 to sample continuously at 4 Hz and average samples taken within each sample interval [SI=] seconds, store averaged data in memory, and transmit averaged data real-time. x=N: Set SBE 21 to take 1 sample every sample interval [SI=] seconds, store data in memory, and transmit data real-time.
	SI=x	x= interval (seconds) between samples or sample averages (3 - 600 seconds).
	IL	After all data uploaded, send IL before starting to log to make entire memory available for recording. Equivalent to SampleNumber=0 and HeaderNumber=0 .
	SampleNumber=x	x= sample number for first sample when logging begins. After all data has been uploaded, set to 0 before starting to log to make entire memory available for recording.
	HeaderNumber=x	x= header number for first header when logging begins.
	GL	Start logging now; SBE 21 requests verification. SBE 21 starts logging at beginning of memory, overwriting any samples and headers in memory.
	RL	Resume logging now, placing data in memory <i>after</i> last sample (SBE 21 does not overwrite samples or headers in memory).
	AutoRun=x	x=Y: Automatically start logging when power applied, placing data in memory <i>after</i> last sample (SBE 21 does not overwrite any samples or headers in memory). x=N: Do not automatically start logging when power applied.
	QL	Stop logging. Press Enter key before entering QL . Must stop logging before uploading data.

Note:
Use Upload on the Toolbar or Upload Data in the Data menu to upload data that will be processed by SBE Data Processing. Manually entering **DDb,e** does not produce data with the required header information for processing by SBE Data Processing.

CATEGORY	COMMAND	DESCRIPTION
Data Upload	DDb,e	Upload data beginning with scan b, ending with scan e. Stop logging before sending DDb,e .
	DH	Upload all headers. Stop logging before sending DH .
Sampling	SS	Output last sample from buffer.
	TS	Take sample, store data in buffer (but not in FLASH memory), output data.
Diagnostics Outputs 100 samples for each test; data not stored in FLASH memory. Press Esc key or Stop button to stop test.	FR	Display frequencies: raw temperature A/D counts, raw conductivity frequency, temperature frequency converted to match older SBE 21 (firmware version < 4.0), and conductivity frequency converted to match older SBE 21 (firmware version < 4.0).
	VR	Display voltages with offset and scale factors applied: external (auxiliary sensor) voltage 0, 1, 2, and 3; external power voltage / 11, back-up lithium battery voltage / 3.741, operating current / 333.33.
	T38	Display output from SBE 38 remote temperature sensor.
Calibration Coefficients	Voffset0= VSlope0= Voffset1= VSlope1= Voffset2= VSlope2= Voffset3= VSlope3=	Factory set
Hardware Configuration	<i>Factory settings – do not modify in the field</i> SetMfgDate= SetPcbSerialNum1=, SetPcbSerialNum2=, SetPcbSerialNum3=, SetPcbSerialNum4= SetPcbAssembly1=, SetPcbAssembly2=, SetPcbAssembly3=, SetPcbAssembly4= <i>Auxiliary Sensor Settings – can be modified in the field to accommodate changes in auxiliary sensors cabled to SBE 21</i> SetVoltType0=, SetVoltSN0= SetVoltType1=, SetVoltSN1= SetVoltType2=, SetVoltSN2= SetVoltType3=, SetVoltSN3=	

Appendix IV: AF24173 Anti-Foulant Device

AF24173 Anti-Foulant Devices supplied for user replacement are supplied in polyethylene bags displaying the following label:

AF24173 ANTI-FOULANT DEVICE

FOR USE ONLY IN SEA-BIRD ELECTRONICS' CONDUCTIVITY SENSORS TO CONTROL THE GROWTH OF AQUATIC ORGANISMS WITHIN ELECTRONIC CONDUCTIVITY SENSORS.

ACTIVE INGREDIENT:

Bis(tributyltin) oxide.....	53.0%
OTHER INGREDIENTS:	<u>47.0%</u>
Total.....	100.0%

DANGER

See the complete label within the Conductivity Instrument Manual for Additional Precautionary Statements and Information on the Handling, Storage, and Disposal of this Product.

Net Contents: Two anti-foulant devices

Sea-Bird Electronics, Inc.
13431 NE 20th Street
Bellevue, WA 98005

EPA Registration No. 74489-1
EPA Establishment No. 74489-WA-1

AF24173 Anti-Foulant Device

FOR USE ONLY IN SEA-BIRD ELECTRONICS' CONDUCTIVITY SENSORS TO CONTROL THE GROWTH OF AQUATIC ORGANISMS WITHIN ELECTRONIC CONDUCTIVITY SENSORS.

ACTIVE INGREDIENT:

Bis(tributyltin) oxide.....	53.0%
OTHER INGREDIENTS:	47.0%
Total.....	100.0%

DANGER

See Precautionary Statements for additional information.

FIRST AID	
If on skin or clothing	<ul style="list-style-type: none"> • Take off contaminated clothing. • Rinse skin immediately with plenty of water for 15-20 minutes. • Call a poison control center or doctor for treatment advice.
If swallowed	<ul style="list-style-type: none"> • Call poison control center or doctor immediately for treatment advice. • Have person drink several glasses of water. • Do not induce vomiting. • Do not give anything by mouth to an unconscious person.
If in eyes	<ul style="list-style-type: none"> • Hold eye open and rinse slowly and gently with water for 15-20 minutes. • Remove contact lenses, if present, after the first 5 minutes, then continue rinsing eye. • Call a poison control center or doctor for treatment advice.
HOT LINE NUMBER	
Note to Physician	Probable mucosal damage may contraindicate the use of gastric lavage.
Have the product container or label with you when calling a poison control center or doctor, or going for treatment. For further information call National Pesticide Telecommunications Network (NPTN) at 1-800-858-7378.	

Net Contents: Two anti-foulant devices

Sea-Bird Electronics, Inc.
13431 NE 20th Street
Bellevue, WA 98005

EPA Registration No. 74489-1
EPA Establishment No. 74489-WA-1

PRECAUTIONARY STATEMENTS

HAZARD TO HUMANS AND DOMESTIC ANIMALS

DANGER

Corrosive - Causes irreversible eye damage and skin burns. Harmful if swallowed. Harmful if absorbed through the skin or inhaled. Prolonged or frequently repeated contact may cause allergic reactions in some individuals. Wash thoroughly with soap and water after handling.

PERSONAL PROTECTIVE EQUIPMENT

USER SAFETY RECOMMENDATIONS

Users should:

- Remove clothing immediately if pesticide gets inside. Then wash thoroughly and put on clean clothing.
- Wear protective gloves (rubber or latex), goggles or other eye protection, and clothing to minimize contact.
- Follow manufacturer's instructions for cleaning and maintaining PPE. If no such instructions for washables, use detergent and hot water. Keep and wash PPE separately from other laundry.
- Wash hands with soap and water before eating, drinking, chewing gum, using tobacco or using the toilet.

ENVIRONMENTAL HAZARDS

Do not discharge effluent containing this product into lakes, streams, ponds, estuaries, oceans, or other waters unless in accordance with the requirements of a National Pollutant Discharge Elimination System (NPDES) permit and the permitting authority has been notified in writing prior to discharge. Do not discharge effluent containing this product to sewer systems without previously notifying the local sewage treatment plant authority. For guidance contact your State Water Board or Regional Office of EPA. This material is toxic to fish. Do not contaminate water when cleaning equipment or disposing of equipment washwaters.

PHYSICAL OR CHEMICAL HAZARDS

Do not use or store near heat or open flame. Avoid contact with acids and oxidizers.

DIRECTIONS FOR USE

It is a violation of Federal Law to use this product in a manner inconsistent with its labeling. For use only in Sea-Bird Electronics' conductivity sensors. Read installation instructions in the applicable Conductivity Instrument Manual.

STORAGE AND DISPOSAL

PESTICIDE STORAGE: Store in original container in a cool, dry place. Prevent exposure to heat or flame. Do not store near acids or oxidizers. Keep container tightly closed.

PESTICIDE SPILL PROCEDURE: In case of a spill, absorb spills with absorbent material. Put saturated absorbent material to a labeled container for treatment or disposal.

PESTICIDE DISPOSAL: Pesticide that cannot be used according to label instructions must be disposed of according to Federal or approved State procedures under Subtitle C of the Resource Conservation and Recovery Act.

CONTAINER HANDLING: Nonrefillable container. Do not reuse this container for any purpose. Offer for recycling, if available.

Appendix V: Replacement Parts

Part Number	Part	Application Description	Quantity in SBE 21
801542	AF24173 Anti-Foulant Device	Bis(tributyltin) oxide device inserted into anti-foulant device mount kit	1 (set of 2)
50315	External anti-foulant device mount kit (contains 2 mounting cups and caps and Tygon tubing)	For placement at both ends of conductivity cell, to hold AF24173 Anti-Foulant Device	1
80438	4-pin RMG-4FS to 4-pin MS3106A-14S-2P I/O cable, 10 m (33 ft) long	From SBE 21 to Interface Box	1
171887	9-pin DB-9P to 9-pin DB-9S I/O cable, 3.0 m (10 ft) long	From Interface Box to computer	1
171888	25-pin DB-25S to 9-pin DB-9P cable adapter	For use with computer with DB-25 connector	1
171012	4-pin RMG-4FS to 4-pin RMG-4FS cable, 10 m (33 ft) long	From SBE 38 remote temperature sensor to SBE 21	1
23388.2	Top end cap blank	Seals flow chamber when electronics/sensor assembly removed from water jacket for recalibration/repair	
22009	Panasonic BR 2/3 A lithium batteries	Permits orderly shut-down in event of removal of power	2
50298	Thermosalinograph spares kit (compatible with SBE 38)	Spare parts, including: <ul style="list-style-type: none"> • 17628 6-pin bulkhead connector • 17654 4-pin bulkhead connector • 30384 Tygon tube, 7/16" x 1/16" (storage hose for conductivity cell) • 30411 Triton X100, 500ml (Octyl Phenol Ethoxylate – Reagent grade non-ionic cleaning solution for conductivity cell, supplied in 100% strength; dilute as directed) • 30457 Parker O-Lube (o-ring lubricant) • 50106 SBE 21 Spare O-Ring/Hardware Kit 	-

Continued on next page

Continued from previous page

Part Number	Part	Application Description	Quantity in SBE 21
50106	Spare o-ring/hardware kit	<p>O-rings and hardware, including:</p> <ul style="list-style-type: none"> • 30072 Parker 2-017N674-70 o-ring (for bulkhead connectors) • 30092 Parker 2-363N674-70 o-ring (SBE 21 top plate to square end cap seal) • 30390 Parker 2-012N674-70 o-ring (cell tray face seal) • 30809 Morrison seal (for temperature probe) • 30815 Parker 2-233E603-70 (for sensor/electronics module end cap) • 30200 Bolt, 3/8-16 x 3 3/4 Hex, stainless steel (square end cap to SBE 21 top plate) • 30210 Nut, 3/8-16 nylon stop, stainless steel (for 30200) • 30257 Washer, 3/8 flat, stainless steel, 7/8 OD (for 30200) • 30362 Nut, 6-32 nylon stop (boardset to sensor end cap) • 30491 Machine screw, 8-32 x 5/16, titanium (attach conductivity cell guard to sensor/electronics module housing) • 30444 Bolt, 10-24 x 1/2 hex head, titanium (attach conductivity cell guard to sensor/electronics module end cap) • 30445 Screw 10-24 x 3/4 RH, titanium (cell tray to end cap) • 30493 Machine screw, 10-24 x 1 1/4 hex head, titanium (attach sensor/electronics module end cap to housing) 	

Index

.con file · 36, 38, 45
.xmlcon file · 36, 38, 45

9

90158.1 Interface Box · 16
90488 Interface Box · 8, 17, 18, 38, 42

A

Anti-foulant device fitting · 54
Anti-Foulant Devices · 66

B

Baud rate · 11, 46

C

Calibration · 56
Calibration coefficient commands · 36
Circuitry · 61
Cleaning · 55
Clock · 61
Command summary · 64
Commands
 calibration coefficients · 36
 data upload · 35
 descriptions · 23
 diagnostic · 36
 hardware configuration · 37
 logging · 32
 polled sampling · 35
 sampling · 35
 setup · 31
 status · 24
Communication defaults · 20
Configuration file · 36, 38, 45
Connectors · 10
Corrosion precautions · 54

D

Data
 acquisition · 46
 bits · 11
 format · 40
 storage · 11
Data processing · 52
Data upload commands · 35
Description · 7
Diagnostic commands · 36
Dimensions · 10

E

Editing data files · 52
Electrical installation · 16
Electronics · 61
 disassembly/reassembly · 62

F

Format
 data · 40
Functional description · 61

G

Glossary · 60

H

Hardware configuration commands · 37

I

Installation
 electrical · 16
 mechanical · 15
 remote temperature sensor · 11
Installation guidelines · 13
Interface Box · 8, 16, 17, 18, 38, 42

L

Logging commands · 32

M

Maintenance · 54
Mechanical installation · 15

N

Navigation · *See* NMEA
NMEA · 38, 42
 operating modes · 42
 setup · 43
 testing · 43
 troubleshooting · 45

O

Operating modes · 42

P

Parity · 11
Parker Super O-Lube · 60
Parts
 replacement · 70
Plumbing · 13
PN 90158.1 Interface Box · 16
PN 90488 Interface Box · 8, 17, 18, 38, 42
Polled sampling commands · 35
Power · 61
Processing data · 52

R

Real-time acquisition · 46
Remote temperature sensor · 11, 31, 38
Removing sensor/electronics module · 54
Replacement parts · 70

S

Sampling commands · 35
SBE 38 · 11, 31, 38
 data format · 41
SBE Data Processing · 8, 12, 51
Schematic · 13
Seasave · 8, 12, 38, 46, 51
SEASOFT · 8, 12
SEATERM · 8, 12, 18, 49
 toolbar buttons · 19
sensor/electronics module · 54
Sensors · 61
Setting up SBE 21 · 18
Setup commands · 31
Software · 8, 12
Specifications · 9
Status commands · 24
Stop bits · 11
Storage · 55
Super O-Lube · 60
System
 description · 7
 schematic · 13

T

Testing · 18, 43
Triton · 55, 60
Troubleshooting · 55, 57

U

Unpacking · 6
Uploading data · 49

V

Voltage sensors · 31