

# SBE 26*plus* SEAGAUGE

## Wave and Tide Recorder

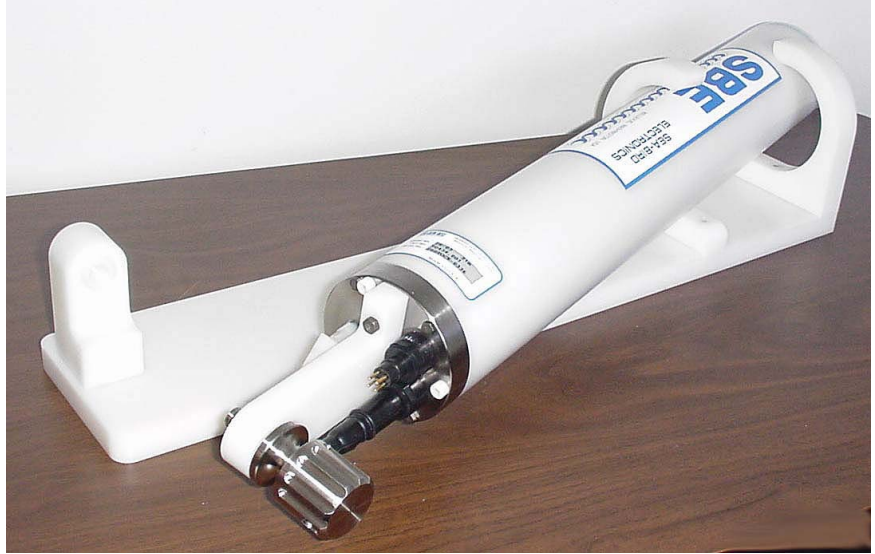

*Shown in optional mounting fixture*

**Note: NEW  
ADDRESS**  
as of January 18, 2010

## User's Manual

Sea-Bird Electronics, Inc.  
13431 NE 20<sup>th</sup> Street  
Bellevue, Washington 98005 USA  
Telephone: 425-643-9866  
Fax: 425-643-9954  
E-mail: [seabird@seabird.com](mailto:seabird@seabird.com)  
Website: [www.seabird.com](http://www.seabird.com)

Manual Version #014, 02/01/10  
Quartz Firmware Version 6.1d and later  
Strain Gauge Firmware Version 6.1c and later  
SEASOFT for Waves Version 1.18b and later



## **Limited Liability Statement**

Extreme care should be exercised when using or servicing this equipment. It should be used or serviced only by personnel with knowledge of and training in the use and maintenance of oceanographic electronic equipment.

SEA-BIRD ELECTRONICS, INC. disclaims all product liability risks arising from the use or servicing of this system. SEA-BIRD ELECTRONICS, INC. has no way of controlling the use of this equipment or of choosing the personnel to operate it, and therefore cannot take steps to comply with laws pertaining to product liability, including laws which impose a duty to warn the user of any dangers involved in operating this equipment. Therefore, acceptance of this system by the customer shall be conclusively deemed to include a covenant by the customer to defend, indemnify, and hold SEA-BIRD ELECTRONICS, INC. harmless from all product liability claims arising from the use or servicing of this system.

# Table of Contents

<b>Section 1: Introduction</b> .....	<b>6</b>
About this Manual .....	6
Quick Start .....	6
Unpacking SBE 26plus .....	7
<b>Section 2: Description of SBE 26plus</b> .....	<b>8</b>
System Description .....	8
Specifications.....	10
Dimensions and End Cap Connectors.....	12
Power Supply.....	13
External Power and Cable Length .....	13
Limiting Communication IR Loss to 1 Volt if Transmitting	
Real-Time Data.....	13
Supplying Enough Power to SBE 26plus .....	14
Data I/O .....	14
Real-Time Setup .....	15
Baud Rate and Cable Length – Standard RS-232 Interface.....	15
Baud Rate and Cable Length – Optional RS-422 / RS-485	
(full duplex) Interface.....	15
Real-Time Data Acquisition .....	15
<b>Section 3: Software Installation and Use</b> .....	<b>16</b>
Software Installation .....	16
SEASOFT for Waves .....	16
Extract Tide .....	16
SEASOFT for Waves Use .....	17
File Types .....	18
<b>Section 4: Pre-Deployment Planning – Plan Deployment and</b>	
<b>Battery and Memory Endurance</b> .....	<b>19</b>
Plan Deployment.....	19
Battery and Memory Endurance .....	21
Battery Endurance – with Quartz Pressure Sensor .....	22
Battery Endurance – with Strain Gauge Pressure Sensor .....	23
Memory Endurance .....	24
<b>Section 5: SBE 26plus Setup, Installation, and Data Upload -</b>	
<b>SeatermW</b> .....	<b>25</b>
Programming for Deployment - SeatermW .....	25
Command Descriptions.....	30
General Command Notes.....	30
Commands .....	32
Using SBE 26plus as a Tide Recorder .....	48
Using SBE 26plus as a Wave Recorder .....	48
Setting Time in SBE 26plus to Synchronize Sampling of	
Multiple Instruments.....	49
Installing and Deploying SBE 26plus.....	50
Recovering SBE 26plus .....	51
Uploading Data from Memory.....	52
<b>Section 6: Conversion into Tide and Wave Files – Extract Tide and</b>	
<b>Convert Hex</b> .....	<b>54</b>
Extract Tide.....	54
Convert Hex .....	55

<b>Section 7: Tide Data Processing – Merge Barometric Pressure</b> .....	<b>57</b>
Input Barometric Pressure File Format.....	59
Merge Barometric Pressure Algorithm.....	59
<b>Section 8: Wave Data Processing – Process Wave Burst Data and Create Reports</b> .....	<b>60</b>
Process Wave Burst Data.....	60
Create Reports: Summarize Wave Data.....	64
<b>Section 9: Data Plotting – Plot Data</b> .....	<b>68</b>
File Setup Tab.....	68
Plot Setup Tab.....	69
X Axis Tab.....	70
Y Axis Tab.....	72
Viewing and Outputting Plots.....	73
<b>Section 10: Routine Maintenance and Calibration</b> .....	<b>75</b>
Corrosion Precautions.....	75
Connector Mating and Maintenance .....	75
Battery Replacement.....	76
Pressure Sensor Maintenance .....	77
Conductivity Cell Maintenance .....	80
Sensor Calibration.....	81
<b>Section 11: Troubleshooting</b> .....	<b>84</b>
Problem 1: Unable to Communicate with SBE 26plus .....	84
Problem 2: Nonsense or Unreasonable <i>Uploaded</i> Data .....	85
Problem 3: Nonsense or Unreasonable <i>Real-Time</i> Data .....	85
<b>Glossary</b> .....	<b>86</b>
<b>Appendix I: Command Summary</b> .....	<b>88</b>
<b>Appendix II: Sample Timing</b> .....	<b>91</b>
General Sample Timing Notes.....	91
Sample Timing with Quartz Pressure Sensor.....	91
Sample Timing with Strain Gauge Pressure Sensor.....	95
<b>Appendix III: Data Formats</b> .....	<b>98</b>
Real-Time Data Format (.cap extension).....	98
Hex Data Format with <i>Quartz</i> Pressure Sensor (.hex extension).....	100
Setup Parameters and Tide Data – with <i>Quartz</i> Pressure .....	102
Wave Burst Data – with <i>Quartz</i> Pressure .....	104
Hex Data Format with <i>Strain Gauge</i> Pressure Sensor (.hex extension).....	106
Setup Parameters and Tide Data – with <i>Strain Gauge</i> Pressure .....	108
Wave Burst Data – with <i>Strain Gauge</i> Pressure .....	110
Tide Data Format (.tid extension).....	112
Wave Burst Data Format (.wb extension).....	112
Wave Burst Auto-Spectrum Statistics (.was extension).....	113
Wave Burst Auto-Spectrum Report (.rpt extension).....	114
Surface Wave Time Series Statistics (.wts extension).....	115
Surface Wave Time Series (.wt extension).....	116
Wave Burst Statistics Report (.r26 extension).....	116
<b>Appendix IV: Electronics Disassembly/Reassembly</b> .....	<b>117</b>
<b>Appendix V: AF24173 Anti-Foulant Device</b> .....	<b>119</b>

---

<b>Appendix VI: Wave Theory and Statistics .....</b>	<b>123</b>
Surface Gravity Waves - Description .....	123
Types of Waves and Restoring Forces.....	123
Spectrum of Surface Waves in the Ocean.....	123
Definition of Terms .....	124
Basic Linear Wave Description .....	124
Phase Angle .....	125
Dispersion Equation.....	125
Implications of Linear Theory .....	125
Assumptions .....	126
Subsurface Pressure Due to Surface Gravity Waves .....	127
High Frequency Cutoff .....	128
Wave Processing Steps .....	129
Initial Processing of Pressure Data .....	129
Surface Wave Auto-Spectrum .....	130
Surface Wave Time Series.....	133
<b>Appendix VII: Pressure-to-Depth Conversion.....</b>	<b>136</b>
<b>Appendix VIII: References .....</b>	<b>137</b>
<b>Appendix IX: Replacement Parts .....</b>	<b>138</b>
<b>Index.....</b>	<b>140</b>

# Section 1: Introduction

This section includes a Quick Start procedure, and photos of a standard SBE 26plus.

---

## About this Manual

This manual is for use with the SBE 26plus SEAGAUGE Wave and Tide Recorder. It is organized to guide the user from installation through operation, data collection, and processing. We have included detailed specifications, command descriptions, maintenance and calibration information, and helpful notes throughout the manual.

Sea-Bird welcomes suggestions for new features and enhancements of our products and/or documentation. Please contact us with any comments or suggestions (seabird@seabird.com or 425-643-9866). Our business hours are Monday through Friday, 0800 to 1700 Pacific Standard Time (1600 to 0100 Universal Time) in winter and 0800 to 1700 Pacific Daylight Time (1500 to 0000 Universal Time) the rest of the year.

---

## Quick Start

Follow these steps to get a Quick Start using the SBE 26plus. The manual provides step-by-step details for performing each task.

### ***Deployment:***

1. Run Plan Deployment and Battery and Memory Endurance to determine sampling parameters (*Section 4*).
2. Install new batteries.
3. Connect 26plus to computer and run SeatermW (*Section 5*):
  - A. Ensure all data has been uploaded, and then send **InitLogging** to make entire memory available for recording if desired.
  - B. Set date and time (**SetTime**) and wave and tide sampling parameters (**SetSampling**); enable conductivity if SBE 4M conductivity sensor is installed (**Conductivity=Y**); enable external thermistor if optional external thermistor installed (**ExternalTemperature=Y**).
  - C. Check status (**DS**) and calibration coefficients (**DC**).
  - D. Start logging (**Start**).

### ***Recovery and Data Processing:***

1. Connect 26plus to computer and run SeatermW. Stop logging (**Stop**), and upload data from 26plus memory (*Section 5*).
2. If the uploaded data is from multiple logging sessions, run Extract Tide to create a separate file for each logging session (*Section 6*).
3. Run Convert Hex to convert uploaded data into separate wave and tide files (*Section 6*).
4. Run Merge Barometric Pressure to remove barometric pressure from tide file (*Section 7*).
5. Run Process Wave Burst Data and Create Reports to calculate and summarize wave statistics (*Section 8*).
6. Run Plot Data to display the data (*Section 9*).

## Unpacking SBE 26plus

Shown below is a typical SBE 26plus shipment.



SBE 26plus



I/O Cable



Pressure sensor  
oil refill kit



Spare battery end cap  
hardware and o-ring kit



Spare hardware kit



Jackscrew kit



26plus manual



Software, and electronic copies of  
software manuals and user manual

# Section 2: Description of SBE 26plus

This section describes the functions and features of the SBE 26plus, including specifications, dimensions, end cap connectors, power supply and cable length limitations, data I/O protocols, and real-time setup.

---

## System Description

The SBE 26plus SEAGAUGE Wave and Tide Recorder combines Sea-Bird's non-volatile FLASH memory with a stable time base, quartz pressure sensor, precision thermometer, and an optional SBE 4M conductivity sensor to provide wave and tide recording and real-time data of unprecedented resolution and accuracy.

- For tide and water level monitoring, the pressure sensor output is integrated to average out wave action. The user-programmable tide interval can be set from 1 minute to 12 hours. The 26plus can continuously measure pressure (if equipped with Quartz pressure sensor), or can conserve battery power by measuring pressure for only a portion of the tide interval, with the pressure sensor not drawing power for the remainder of the interval. The tide integration duration is programmable from 10 seconds to the entire user-programmable tide interval. High-accuracy temperature information is recorded with each tide measurement. As an option, an SBE 4M conductivity sensor can be integrated for recording conductivity data with each tide measurement. Tide data is always recorded in memory; in addition, real-time tide data can be output.
- Waves are characterized by burst sampling, with the number of samples per burst, burst interval, and burst integration time programmed by the user. Wave data is always recorded in memory; in addition, real-time wave data and/or real-time wave statistics can be output.

The 26plus is self-contained in a rugged, non-corroding, plastic housing (600-meter depth rating). After recovery (and without opening the housing), the recorded data is transferred to a computer via an RS-232C (or optional RS-422 / RS-485 full duplex) data link for analysis, plotting, and permanent archiving. The battery compartment contains twelve standard alkaline D-cells (Duracell MN1300, LR20) and is sealed separately to minimize risk to the electronics.

The standard pressure sensor is a 20 meter (45 psia) Paroscientific Digiquartz, with a temperature-compensated quartz element. As an option, the Digiquartz is available in other ranges, from 0.2 to 680 meters (15 to 1000 psia). Another option is substitution of a Druck strain gauge pressure sensor with a temperature-compensated strain gauge element, available in ranges from 20 to 600 meters (45 to 880 psia). The lower-priced Druck sensor is generally intended for wave sampling applications, and will not provide the highest quality tide data.

Temperature is measured with an aged, super-stable thermistor embedded in the 26plus end cap. An AC excitation is applied to a hermetically sealed VISHAY reference resistor and the thermistor. A 24-bit A/D converter digitizes the reference resistor and thermistor outputs.



For the 26plus with **Quartz** pressure sensor, tide measurements are obtained by counting the pressure frequency with a 32-bit ripple counter. Each time the 26plus wakes up, the ripple counters are latched into registers and then reset. The wake-up times are set by a continuously powered, real-time clock with an accuracy of  $\pm 5$  seconds/month. Wave burst measurements are made with a period counter, with its time base generated from a temperature-compensated, precision quartz crystal oscillator.

For the 26plus with **Strain Gauge** pressure sensor, a 24-bit A/D converter digitizes the output of the pressure sensor for the wave and tide measurements.

The standard 26plus includes:

- Plastic housing for depths to 600 meters (1960 ft)
- 20 meter (45 psia) Digiquartz temperature-compensated pressure sensor
- Accurate temperature sensor – aged thermistor embedded in end cap
- Frequency input channel and bulkhead connector for optional SBE 4M conductivity sensor
- 32 MB FLASH memory
- RS-232 interface
- 12 alkaline D-cell batteries (Duracell MN1300, LR20); battery compartment is separated from electronics by a moisture-proof seal
- Impulse glass-reinforced epoxy bulkhead connectors

26plus options include:

- Digiquartz temperature-compensated pressure sensor in ranges from 0.2 to 680 meters (15 to 1000 psia)
- Druck strain gauge pressure sensor, with a temperature-compensated strain gauge element, in ranges from 20 to 600 meters (45 to 880 psia)
- SBE 4M conductivity sensor, interfaced via bulkhead connector and clamped to SBE 26plus housing. SBE 4M comes equipped with expendable AF24173 Anti-Foulant Devices.
- High accuracy external temperature sensor (0.002 °C accuracy, 0.0001 °C resolution) in place of standard internal thermistor (0.01 °C accuracy, 0.001 °C resolution)
- Wet-pluggable (MCBH) bulkhead connectors in place of standard connectors
- Mounting fixture
- RS-422 / RS-485 (full duplex) interface in place of RS-232 interface
- Lithium batteries (six DD drop-in batteries with buttons) for longer deployments (lithium batteries **not** supplied by Sea-Bird). Note that one lithium DD battery is shorter than two alkaline D batteries, so a different battery cover plate is required if using the lithiums (cover plate available from Sea-Bird).

**Notes:**

- Help files provide detailed information on SEASOFT for Waves.
- **SEASOFT for Waves data processing modules cannot process real-time data from the 26plus.**
- Sea-Bird supplies the current version of our software when you purchase an instrument. As software revisions occur, we post the revised software on our FTP site. See our website ([www.seabird.com](http://www.seabird.com)) for the latest software version number, a description of the software changes, and instructions for downloading the software from the FTP site.

Future upgrades and enhancements to the SBE 26plus firmware can be easily installed in the field through a computer serial port and the *Data I/O* bulkhead connector on the 26plus, without the need to return the 26plus to Sea-Bird.

The 26plus is supplied with a modular Windows 95/98/NT/2000/XP software package, SEASOFT for Waves. The software provides pre-deployment planning, communication with the 26plus for setup and uploading of data, separation of the uploaded data into separate wave and tide files, removal of barometric pressure from tide data, statistical analysis, and data plotting.

## Specifications

**Note:**

The pressure sensor is mounted on the titanium connector end cap, with the pressure conveyed from the pressure port to the sensor via an oil-filled tube. The pressure reading is position sensitive as a result of the oil pressure head.

<b>Quartz Pressure (standard)</b>	
<b>Range</b>	0 to 0.2 / 5 / 10 / 20 / 60 / 130 / 200 / 270 / 680 meters (15 / 23 / 30 / 45 / 100 / 200 / 300 / 400 / 1000 psia)
<b>Accuracy</b>	0.01% of full scale (3 mm for 45 psia [20 m] range *)
<b>Repeatability</b>	0.005% of full scale (1.5 mm for 45 psia [20 m] range *)
<b>Hysteresis</b>	0.005% of full scale (1.5 mm for 45 psia [20 m] range *)
<b>Calibration</b>	0 psia to full scale pressure
<b>Resolution *</b>	<i>Tide:</i> 0.2 mm for 1-minute integration; 0.01 mm for 15-minute integration <i>Wave:</i> 0.4 mm for 0.25-second integration; 0.1 mm for 1-second integration
<b>Strain Gauge Pressure (optional, in place of Quartz pressure)</b>	
<b>Range</b>	0 to 20 / 100 / 350 / 600 meters (45 / 160 / 520 / 900 psia)
<b>Accuracy</b>	0.1% of full scale (30 mm for 45 psia [20 m] range *)
<b>Repeatability</b>	0.03% of full scale (9 mm for 45 psia range *)
<b>Hysteresis</b>	0.03% of full scale (9 mm for 45 psia range *)
<b>Calibration</b>	0 psia to full scale pressure
<b>Resolution *</b>	<i>Tide:</i> 0.2 mm for 1-minute integration; 0.01 mm for 15-minute integration <i>Wave:</i> 0.4 mm for 0.25-second integration; 0.1 mm for 1-second integration
<b>Standard Temperature (internal thermistor)</b>	
<b>Range</b>	-5 to +35 °C
<b>Accuracy</b>	0.01 °C
<b>Resolution</b>	0.001 °C
<b>Calibration</b>	+1 to +32 °C (measurements outside this range may be at slightly reduced accuracy due to extrapolation errors)
<b>Optional High Accuracy Temperature (external thermistor)</b>	
<b>Range</b>	-5 to +35 °C
<b>Accuracy</b>	0.002 °C
<b>Resolution</b>	0.0001 °C
<b>Calibration</b>	+1 to +32 °C (measurements outside this range may be at slightly reduced accuracy due to extrapolation errors)
<b>Conductivity (optional SBE 4M conductivity sensor)</b>	
<b>Range</b>	0.0 to 7 S/m
<b>Accuracy</b>	±0.0003 S/m/month (typical); ±0.001 S/m/month (guaranteed; not applicable in areas of high bio-fouling or contamination or if Application Note 2D procedures are not followed)
<b>Resolution</b>	0.00002 S/m
<b>Calibration</b>	2.6 to 6 S/m plus zero conductivity (air)

\*Stated values in mm for accuracy, repeatability, hysteresis, and resolution are for 45 psia (20 m) pressure sensor. Scale for other ranges, multiplying by (actual sensor range in psia / 45 psia).

<b>Other Specifications</b>	
<b>Clocks</b>	<p><b>Counter Time Base</b> (for conductivity, Quartz pressure temperature, &amp; Quartz wave burst data): Quartz TCXO <math>\pm 1</math> ppm per year aging; <math>\pm 15</math> ppm (-20 to +70 °C)</p> <p><b>Real-Time Clock</b> (for Quartz tide pressure data): Quartz TCXO watch-crystal type 32,768 Hz; accuracy <math>\pm 2</math> ppm (5 seconds/month). Battery-backed for minimum of 2-year operation, without the main batteries installed.</p>
<b>Memory</b>	32 MB Flash RAM
<b>Data Storage</b>	<p>If conductivity not enabled: Bytes/day = <math>9N + W</math> (36 + 3M)</p> <p>If conductivity enabled: Bytes/day = <math>12N + W</math> (48 + 3M)</p> <p>(N = tide samples/day, W = wave bursts/day, M = wave measurements/burst)</p>
<b>Power Requirement – 26plus with Quartz Pressure Sensor</b>	<p><b>Quiescent (sleep):</b> 0.0005 watt</p> <p><b>Communications:</b> 0.10 watt</p> <p><b>Data Upload:</b> 0.16 watt</p> <p><b>Wave Burst:</b></p> <p>Wave burst: 0.11 watt</p> <p>Real-time wave statistics: 0.2 watt * 0.06 sec/sample * # of samples/burst</p> <p><b>Tide Sample:</b></p> <p>Pressure sensor integration: 0.01 watt</p> <p>Turn-on for each sample (if going to sleep between samples): 0.30 watt-seconds = 0.30 joules</p> <p>Tide sample (including temperature, but not conductivity): 0.30 watt-seconds = 0.30 joules</p> <p>Conductivity sample: 0.40 watt-seconds = 0.40 joules</p>
<b>Power Requirement – 26plus with Strain Gauge Pressure Sensor</b>	<p><b>Quiescent (sleep):</b> 0.0005 watt</p> <p><b>Communications:</b> 0.13 watt</p> <p><b>Data Upload:</b> 0.19 watt</p> <p><b>Wave Burst:</b></p> <p>Wave burst: 0.14 watt</p> <p>Real-time wave statistics: 0.2 watt * 0.06 sec/sample * # of samples/burst</p> <p><b>Tide Sample:</b></p> <p>Turn-on/off for each tide sample: 0.36 watt-seconds = 0.36 joules</p> <p>Tide sample (including temperature, but not conductivity): 0.14 watt</p> <p>Conductivity sample: 0.71 watt-seconds = 0.71 joules</p>
<b>Power Supply</b>	<p><b>Standard</b> 12 alkaline D-cell batteries (Duracell MN1300, LR20): Typical capacity 756,000 joules. Sea-Bird recommends derating 15% for safety, and 5% per year for battery self-discharge. Consider derating further for cold water applications.</p> <p><b>Optional:</b> 6 lithium DD-cell batteries (Electrochem BCX85-3B76-TC) with buttons (lithiums <b>not</b> supplied by Sea-Bird). Note that 1 lithium DD is shorter than 2 alkaline Ds, so different battery cover plate required (cover plate available from Sea-Bird). Typical capacity 2,332,800 joules. Sea-Bird recommends derating 15% for safety, and 3% per year for battery self-discharge.</p> <p><b>Optional</b> external power source: 12 - 20 VDC.</p>
<b>Housing Materials</b>	600-meter acetal copolymer (plastic) housing, titanium end cap
<b>Weight</b>	<p><b>Plastic housing with alkaline batteries:</b></p> <p>6.8 kg (15 lbs) in air, 2.3 kg (5 lbs) in water</p> <p><b>Optional mounting fixture:</b></p> <p>3.6 kg (8 lbs) in air, 1.4 kg (3 lbs) in water</p>

**Note:**  
See Section 4: Pre-Deployment Planning – Plan Deployment and Battery and Memory Endurance.

# Dimensions and End Cap Connectors

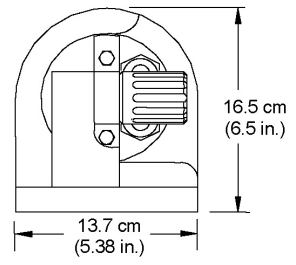
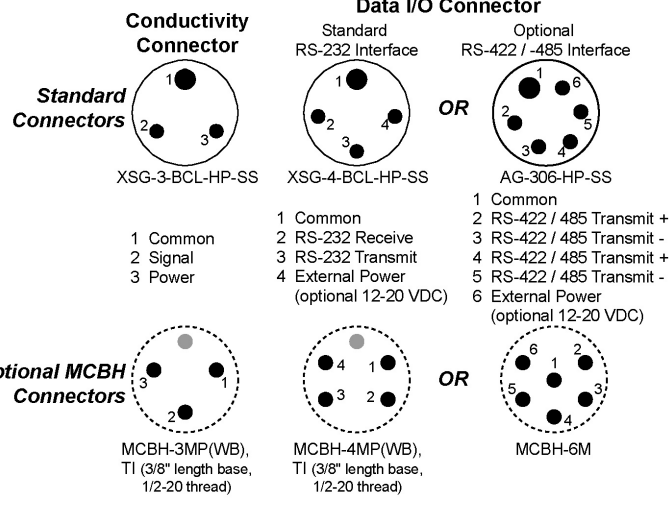
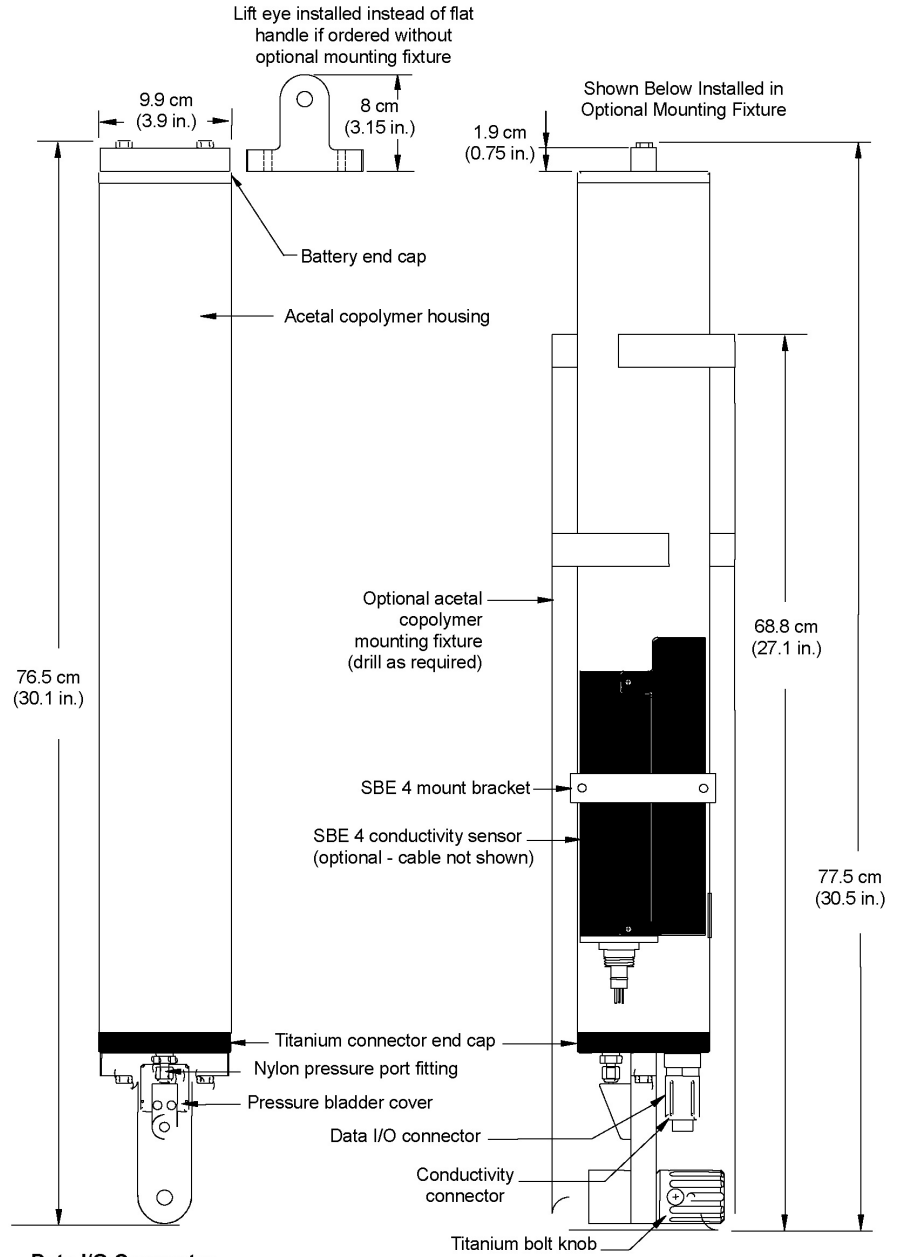

## Power Supply

### Notes:

- For battery endurance calculations, see *Section 4: Pre-Deployment Planning – Plan Deployment and Battery and Memory Endurance*.
- The cut-off voltage is 10.4 volts. If the voltage falls below that, the 26plus provides a warning message, and will not take measurements.

The main batteries for a standard SBE 26plus are 12 D-cell alkaline batteries (Duracell MN 1300, LR20). The 26plus can also be powered by 6 DD-cell batteries with buttons (batteries **not** supplied by Sea-Bird).

The 26plus can be powered from an external 12-20 VDC source. The internal batteries are diode-OR'd with the external source, so power is drawn from whichever voltage source is higher.

On-board lithium batteries (non-hazardous units which are unrestricted for shipping purposes) are provided to back-up the buffer and the real-time clock in the event of main battery failure, exhaustion, or removal. The main batteries can be replaced without affecting either the real-time clock or the memory. If the main power supply falls below 9 VDC, the 26plus will draw power from the back-up lithium batteries.

## External Power and Cable Length

### Note:

See *Real-Time Setup* below for baud rate limitations on cable length if transmitting real-time data.

There are two issues to consider if powering the SBE 26plus externally:

- Limiting the communication IR loss to 1 volt **if transmitting real-time data**; higher IR loss will prevent the instrument from transmitting real-time data because of the difference in ground potential.
- Supplying enough power at the power source so that sufficient power is available at the instrument after considering IR loss.

Each issue is discussed below.

### Note:

Common wire resistances:

Gauge	Resistance (ohms/foot)
12	0.0016
14	0.0025
16	0.0040
18	0.0064
19	0.0081
20	0.0107
22	0.0162
24	0.0257
26	0.0410
28	0.0653

### Limiting Communication IR Loss to 1 Volt if Transmitting Real-Time Data

The limit to cable length is typically reached when the maximum current **during communication** times the power common wire resistance is more than 1 volt, because the difference in ground potential of the 26plus and ground controller prevents the 26plus from transmitting real-time data.

$$V_{\text{limit}} = 1 \text{ volt} = IR_{\text{limit}}$$

$$\text{Maximum cable length} = R_{\text{limit}} / \text{wire resistance per foot}$$

where  $I$  = maximum current required by 26plus during communication.

From *Specifications*, upload power required is 0.16 watt for 26plus with Quartz pressure or 0.19 watt for 26plus with Strain Gauge pressure. Conservatively use 0.20 watts for both, and use 12 V (minimum input voltage) to calculate:

$$I * V = \text{watts}$$

$$I = 0.20 \text{ watts} / 12\text{V} = 0.017 \text{ amps}$$

*Example 1* – For 20 gauge wire, what is maximum distance to transmit power to 26plus if transmitting real-time data?

For upload current,  $R_{\text{limit}} = V_{\text{limit}} / I = 1 \text{ volt} / 0.017 \text{ amps} = 58.8 \text{ ohms}$

For 20 gauge wire, resistance is 0.0107 ohms/foot.

Maximum cable length =  $58.8 \text{ ohms} / 0.0107 \text{ ohms/foot} = 5495 \text{ feet} = 1675 \text{ meters}$

*Example 2* – Same as above, but there are 4 instruments powered from the same power supply.

For 60 milliamp communications current,  $R_{\text{limit}} = V_{\text{limit}} / I = 1 \text{ volt} / (0.017 \text{ amps} * 4 \text{ instruments}) = 14.7 \text{ ohms}$

Maximum cable length =  $14.7 \text{ ohms} / 0.0107 \text{ ohms/foot} = 1373 \text{ feet} = 418 \text{ meters}$  (to 26plus furthest from power source).

## Supplying Enough Power to SBE 26plus

Another consideration in determining maximum cable length is supplying enough power at the power source so that sufficient voltage is available, after IR loss in the cable, to power the SBE 26plus externally.

Power required for the conductivity measurement is 0.3 watt for 26plus with Quartz pressure or 0.33 watt for 26plus with Strain Gauge pressure; conservatively use 0.33 watts for both. If not integrating a conductivity sensor with the 26plus, the next highest power draw is 0.225 watts for 26plus with Quartz pressure or 0.2 watts for 26plus with Strain Gauge pressure; conservatively use 0.225 watts for both. Use 12 V (minimum input voltage) to calculate:

$$I * V = \text{watts}$$

$$\text{With conductivity: } I = 0.33 \text{ watts} / 12\text{V} = 0.028 \text{ amps}$$

$$\text{Without conductivity: } I = 0.225 \text{ watts} / 12\text{V} = 0.019 \text{ amps}$$

*Example 1* – For 20 gauge wire, what is maximum distance to transmit power to 26plus with an integrated conductivity sensor from a 12 VDC power supply?

The 26plus external power specification is 12 – 20 VDC. The battery cut-off (point at which 26plus stops taking measurements) is 10.4 V. Therefore, a 1.6 V IR drop (12 V – 10.4 V) would still provide enough power to the 26plus.

$$V = IR \quad 1.4\text{V} = 0.028 \text{ amps} * (0.0107 \text{ ohms/foot} * \text{cable length})$$

$$\text{Maximum cable length} = 4670 \text{ ft} = 1420 \text{ meters}$$

Note that 1420 meters < 1675 meters (maximum distance if 26plus is transmitting real-time data), so IR drop in power is controlling factor for this example. Using a higher voltage power supply or a different wire gauge would increase allowable cable length.

*Example 2* – Same as above, but there are 4 instruments powered from same power supply.

$$1.4\text{V} = 0.028 \text{ amps} * 4 \text{ instruments} * (0.0107 \text{ ohms/foot} * \text{cable length})$$

$$\text{Maximum cable length} = 1168 \text{ ft} = 356 \text{ meters (to 26plus furthest from power source)}$$

## Data I/O

The SBE 26plus receives setup instructions and outputs diagnostic information or previously recorded data via a three-wire RS-232 link (optional RS-422 / RS-485 full duplex). The 26plus is factory-configured for 9600 baud, 8 data bits, 1 stop bit, and no parity. The communications baud rate can be changed using **Baud**= (see *Section 5: SBE 26plus Setup, Installation, and Data Upload – SeatermW*). Standard ASCII data upload from memory is done at the communications baud rate. Binary data upload from memory can be accomplished at rates of up to 115,200 baud, regardless of the setting for the communications baud rate.

## Real-Time Setup

### Baud Rate and Cable Length – Standard RS-232 Interface

The length of cable that the SBE 26plus can drive is dependent on the baud rate. The allowable combinations are:

Maximum Cable Length (meters)	Maximum Baud Rate
1600	600
800	1200
400	2400
200	4800
100	9600
50	19200
25	38400
16.7	57600 *
13.3	115200 *

\* 57600 and 115200 baud are available only for binary upload, and are not applicable to real-time data output.

#### Notes:

- Set:  
Baud rate with **Baud=**.  
**TxTide=Y** for real-time tide data.  
**TxWave=Y** for real-time wave data.  
**TXWAVESTATS=Y** in **SetSampling** prompt for real-time wave statistics.  
See *Section 5: SBE 26plus Setup, Installation, and Data Upload – SeatermW* for command details.
- If using external power, see *External Power and Cable Length* above for power limitations on cable length.

### Baud Rate and Cable Length – Optional RS-422 / RS-485 (full duplex) Interface

The SBE 26plus can transmit data at up to 38,400 baud over up to 1200 meters of twisted pair wire cable, 26 AWG or smaller gauge (larger diameter). When uploading data, higher baud rates for binary upload (57,600 and 115,200 baud) may not work with long cables.

## Real-Time Data Acquisition

Real-time data (tides, waves, and/or wave statistics) can be acquired by clicking Capture in SeatermW before you begin logging. The data displayed in SeatermW will be saved to the designated file. Process the data as desired. Note that this file **cannot be processed by SEASOFT for Waves, as it does not have the required headers and format for Sea-Bird's processing software.**

# Section 3: Software Installation and Use

**Notes:**

- Help files provide detailed information on SEASOFT for Waves.
- **SEASOFT for Waves data processing modules cannot process real-time data from the 26plus.**
- Sea-Bird supplies the current version of our software when you purchase an instrument. As software revisions occur, we post the revised software on our FTP site. See our website ([www.seabird.com](http://www.seabird.com)) for the latest software version number, a description of the software changes, and instructions for downloading the software from the FTP site.

This section describes the installation and use of SEASOFT for Waves.

The SBE 26plus is supplied with a modular Windows 95/98/NT/2000/XP software package, **SEASOFT for Waves**. The software provides pre-deployment planning, communication with the 26plus for setup and uploading of data from the 26plus, separation of the uploaded data into separate wave and tide files, removal of barometric pressure from tide data, statistical analysis, and data plotting.

The 26plus is supplied with one additional program, **Extract Tide**. Extract Tide splits uploaded data from multiple logging sessions into separate files before converting and processing the data; see *Section 6: Conversion into Tide and Wave Files – Extract Tide and Convert Hex* for details.

ExtractTide.exe is a separate program, but is installed in the same directory as SEASOFT for Waves.

---

## Software Installation

Sea-Bird recommends the following minimum system requirements for installing the software: Pentium 90 CPU, 64 Mbyte RAM, Windows 98 or later. Although SEASOFT for Waves was designed to work with a PC running Windows, extensive testing has not shown any compatibility problems when using the software with a PC running Vista.

### SEASOFT for Waves

If not already installed, install SEASOFT for Waves on your computer using the supplied software CD-ROM:

1. Insert the CD in your CD drive.
2. Install the software: Double click on **SeasoftWaves\_V\*\_\*\*\_.exe** (\*\_\*\* is the software version). Follow the dialog box directions to install the software.

The default location for the software is  
c:\Program Files\Sea-Bird\SeasoftWaves.

### Extract Tide

When you install SEASOFT for Waves, ExtractTide.exe is automatically installed in the same location.



## SEASOFT for Waves Use

Start SEASOFT for Waves by double clicking on **SeasoftWavesLaunch.exe**. The main screen looks like this:

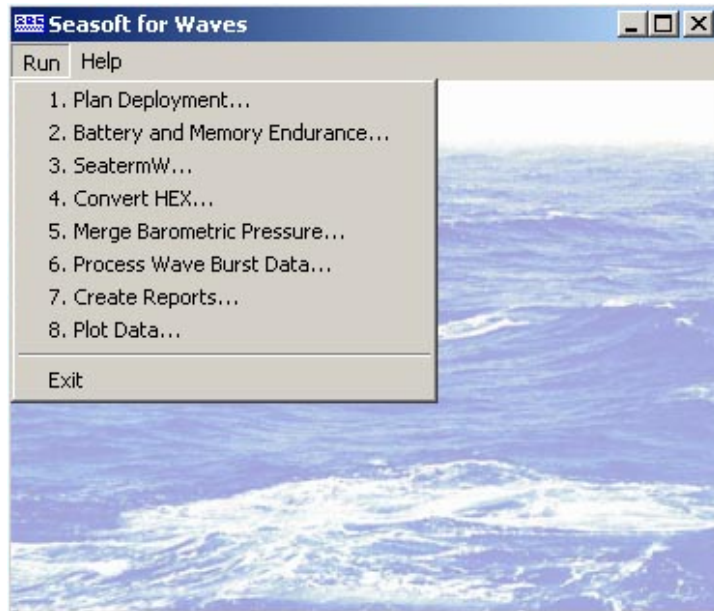

The Run menu lists each program module:

Module Type	Module Name	Module Description
<b>Pre-deployment planning</b> See Section 4	<b>Plan Deployment</b>	Calculate ratio of pressure amplitude measured by instrument to pressure amplitude at surface. Predict number of frequency bands calculated, width of each band, and frequency span.
	<b>Battery and Memory Endurance</b>	Calculate nominal battery and memory endurance for user-specified sampling scheme.
<b>Terminal program</b> See Section 5	<b>SeatermW</b>	Send commands for status, data acquisition setup, diagnostics, and data upload.
<b>Data conversion</b> See Section 6	<b>Convert Hex</b>	Convert uploaded data file into separate wave and tide files, with output data in engineering units.
<b>Tide data processing</b> See Section 7	<b>Merge Barometric Pressure</b>	Remove barometric pressure from tide data.
<b>Wave data processing</b> See Section 8	<b>Process Wave Burst Data</b>	Compute wave statistics.
	<b>Create Reports</b>	Output one line of surface wave time series and/or wave burst auto-spectrum statistics for each processed wave burst.
<b>Data plotting</b> See Section 9	<b>Plot Data</b>	Plot data from a .tid, .wb, .was, .wts, and/or .wt file; plots can be printed. Plot Data can plot data at any point after uploaded hex data is converted into separate wave and tide files in Convert Hex.

## File Types

File extensions are used by SEASOFT for Waves to indicate the file type:

Extension	Description
<b>.bmp</b>	Bitmap graphics file created by Plot Data.
<b>.bp</b>	Barometric pressure data, used by Merge Barometric Pressure to remove barometric pressure from the tide data (.tid) file. This file, <b>not</b> supplied by Sea-Bird, is created by user, based on local barometric pressure data (such as that from a local weather station). See <i>Section 7: Tide Data Processing – Merge Barometric Pressure</i> .
<b>.cap</b>	Real-time data and/or diagnostics captured using SeatermW.
<b>.hex</b>	Data uploaded from 26plus memory using SeatermW. Also, data from multiple logging sessions split into separate files by Extract Tide.
<b>.ini</b>	<p>There are two .ini files used in SEASOFT for Waves:</p> <ul style="list-style-type: none"> <li>SeasoftWaves.ini contains the location and file name of the last saved Program Setup (.psa) file and options settings for each module with a .psa file (Convert Hex, Merge Barometric Pressure, Process Wave Bursts, Create Reports, and Plot Data).</li> <li>SeatermW.ini contains the last instrument type (SBE 26 or 26plus), COM port, and baud rate used in SeatermW for communicating with the instrument.</li> </ul> <p>The .ini files are saved to %USERPROFILE%\Local Settings\Apps\Sea-Bird (<i>Example C:\Documents and Settings\dbresko\Local Settings\Apps\Sea-Bird</i>)</p>
<b>.jpg</b>	JPEG graphics file created by Plot Data.
<b>.psa</b>	<p>Program Setup file, used by Convert Hex, Merge Barometric Pressure, Process Wave Bursts, Create Reports, and Plot Data to store setup information (such as input and output file names and locations, and processing instructions).</p> <p>The user can save the .psa files to the desired locations. As a default, the .psa files are saved to %USERPROFILE%\Application Data\SeasoftWaves (<i>Example C:\Documents and Settings\dbresko\Application Data\Sea-Bird\SeasoftWaves</i>).</p>
<b>.r26</b>	File containing one line of surface wave time series and/or wave burst auto-spectrum statistics for each processed wave burst, created by Create Reports.
<b>.rpt</b>	Summary report, created by Process Wave Burst Data.
<b>.tid</b>	Tide measurements in engineering units, created from uploaded .hex file by Convert Hex. Also, file format for tide data that has had barometric pressure removed by Merge Barometric Pressure.
<b>.was</b>	Statistics and results from auto-spectrum analysis, created by Process Wave Burst Data.
<b>.wb</b>	Wave measurements in engineering units, created from uploaded .hex file by Convert Hex.
<b>.wmf</b>	Windows metafile graphics file created by Plot Data.
<b>.wss</b>	Fast Fourier Transform coefficients, created by Process Wave Burst Data if selected.
<b>.wt</b>	Surface wave time series, created by Process Wave Burst Data if selected.
<b>.wts</b>	Statistics from surface wave zero crossing analysis, created by Process Wave Burst Data.

See *Appendix III: Data Formats* for details on the format of each file.

# Section 4: Pre-Deployment Planning – Plan Deployment and Battery and Memory Endurance

This section covers:

- Planning the required wave burst parameters and placement of the SBE 26plus, using the Plan Deployment module in SEASOFT for Waves.
- Calculating battery and memory endurance for the desired sampling scheme, using the Battery and Memory Endurance module in SEASOFT for Waves.

## Plan Deployment

**Note:**

See *Appendix VI: Wave Theory and Statistics* for a detailed discussion of the theory and equations for wave calculations.

Plan Deployment solves the wave dispersion relation to calculate and plot the pressure attenuation ratio:

$$\text{Pressure attenuation ratio} = \frac{\text{pressure amplitude measured by 26plus}}{\text{pressure amplitude at surface}}$$

given:

- water depth (meters)
- height of pressure sensor above bottom (meters)
- wave period (seconds)

Pressure attenuation with depth is a strong function of the wave period; short period waves are attenuated much faster with depth than longer period waves. This implies that for a pressure sensor deployed at a fixed depth  $z$ , there is a high frequency cut-off  $f_{max}$  for which waves with  $f > f_{max}$  are not measurable. Above the high frequency cut-off, any noise in the subsurface pressure record is mapped by the transfer function into unrealistic surface wave height values.

The default high-frequency cutoff ( $f_{max}$ ) for processing wave data in Process Wave Burst Data is the frequency where the ratio of pressure measured by the 26plus to pressure at the surface is less than  $(0.0025 / \text{wave sample duration})$ . Frequencies greater than  $f_{max}$  are typically not processed by Process Wave Burst Data.

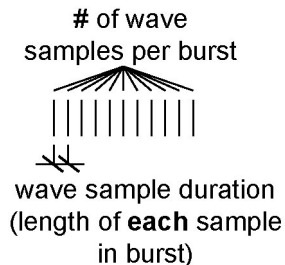

**Note:**

If planning to calculate wave statistics, Sea-Bird recommends the following for meaningful, valid results:

- Samples per burst  $\geq 512$ , and
- Samples per burst = power of 2 (for example, 512, 1024, etc.)

Plan Deployment also predicts these surface wave analysis parameters:

- number of frequency bands calculated
- width of each frequency band (Hz)
- frequency span (Hz)

given:

- water depth (meters)
- height of pressure sensor above bottom (meters)
- wave sample duration (time between successive wave pressure measurements)
- wave samples per burst (multiple of 4; for example, 4, 8, 16, etc.)
- number of spectral estimates for each frequency band

The maximum frequency in the frequency span is the lesser of:

- $0.5 / \text{sample duration}$  (called the Nyquist frequency), or
- frequency ( $f_{max}$  described above) where ratio of pressure measured by 26plus to pressure at surface is less than  $(0.0025 / \text{sample duration})$

*Appendix VI: Wave Theory and Statistics* provides detailed discussion on band averaging.

In SEASOFT for Waves' Run menu, select Plan Deployment. The dialog box looks like this:

Enter values and then click *Calculate Spectral Parameters* to calculate bands, band width, and frequency span, and calculate and plot pressure attenuation. Note that wave sample duration and wave samples per burst are programmed into *26plus* with **SetSampling**.

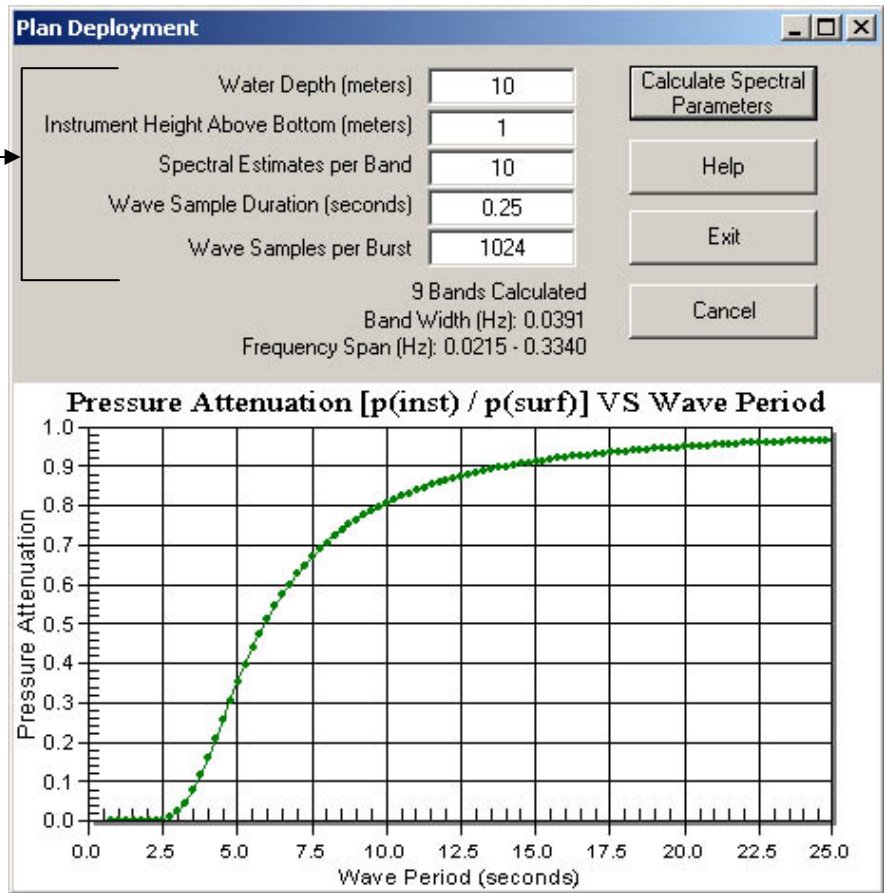

Pressure attenuation is wave pressure amplitude measured by instrument divided by wave pressure amplitude at surface.

**Example:**

Water depth is 10 meters. You are interested in measuring waves with frequencies up to 0.36 Hz (period =  $1 / 0.36 = 2.8$  seconds). You plan to sample waves 4 times per second (wave sample duration = 0.25 seconds) with 1024 samples/wave burst, and to process data with 10 spectral estimates/band. Can you place the *26plus* at 1 meter above the bottom and accomplish your goals?

Running Plan Deployment with the above parameters (see dialog box above), the Frequency Span is 0.0215 to 0.3340 Hz. Since  $0.3340 < 0.36$ , you cannot accomplish your goals.

Iterating on a solution by changing the instrument height in Plan Deployment, you find that placing the *26plus* at 2.5 meters above bottom will allow you to measure the desired frequencies. Alternatively, you could consider modifying other sampling parameters while maintaining the instrument height.

## Battery and Memory Endurance

**Note:**  
See *Specifications in Section 2: Description of SBE 26plus* for power and memory specifications.

Power and memory endurance calculations for the SBE 26plus are complex, and are dependent on the sampling scheme. Use Battery and Memory Endurance to calculate the endurance for a user-specified sampling scheme.

In SEASOFT for Waves' Run menu, select Battery and Memory Endurance. Click on one of the SBE 26plus tabs in the dialog box. The dialog box looks like this:

The screenshot shows the 'Battery and Memory Endurance' dialog box with the following settings and callouts:

- File Help** menu.
- Selected tab: **SBE 26plus-Quartz**.
- Tide measurement interval (minutes) = 60
- Tide measurement duration (seconds) = 120
- Measure waves every N tide samples, N = 6
- Wave samples per burst = 4096
- Wave sample duration (seconds) = 0.25
- Conductivity
- Firmware version 6.0 or greater
- Output real-time wave statistics
- Real-time wave statistics samples per burst = 512
- Wave burst duration (seconds) = 1024
- Wave statistics duration (seconds) = 0
- Nominal alkaline battery endurance (days) = 1011.3
- Nominal lithium battery endurance (days) = 2791.3
- 32 MB Memory endurance (days) = 676.1
- Warning: deployments longer than 2 years are not recommended with alkaline batteries.
- Calculate** button.
- Help** and **Exit** buttons.

**Callouts:**

- Enter tide measurement interval, tide measurement duration, number of tide measurements between each wave burst, wave samples/burst, wave sample duration, and whether conductivity is also measured. Sampling setup is programmed into 26plus with **SetSampling** and **Conductivity=**.
- 26plus firmware  $\geq 6.0$  allows for output of real-time wave statistics. Earlier versions could only output real-time wave burst pressure frequencies. To verify firmware version, send status (**DS**) command in SeatermW; first line of response shows firmware version.
- Time required to calculate real-time wave statistics
- Based on input sampling scheme and memory storage requirements.
- Click **Calculate** to calculate battery endurance and memory endurance.
- 26plus with Quartz and with Strain Gauge pressure sensor have different power requirements. To verify pressure sensor type, send status (**DS**) command in SeatermW; third line of response shows pressure sensor type.
- Real-time statistics samples/burst must be  $\leq$  total wave samples/burst. Real-time setup is programmed into 26plus with **SetSampling**.
- Wave samples/burst \* Wave sample duration
- Battery capacity / daily power consumption
  - **Alkaline** batteries: 5% / year battery discharge and capacity derated 15%
  - **Lithium** batteries: 3% / year battery discharge and capacity derated 15%

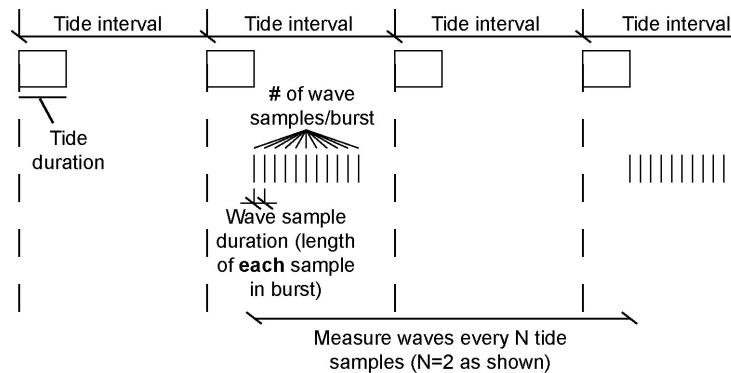

- Notes:**
- This drawing is schematic only, intended to define the sampling scheme terminology. See *Appendix II: Sample Timing* for timing details.
  - See *Command Descriptions in Section 5: SBE 26plus Setup, Installation, and Data Upload – SeatermW* for programming desired sampling scheme in 26plus.
  - If only interested in tide data, see *Using SBE 26plus as a Tide Recorder in Section 5: SBE 26plus Setup, Installation, and Data Upload – SeatermW*.
  - If only interested in wave data, see *Using SBE 26plus as a Wave Recorder in Section 5: SBE 26plus Setup, Installation, and Data Upload – SeatermW*.

**Notes:**

- See *Specifications* in *Section 2: Description of SBE 26plus* for power requirements and alkaline and lithium battery ratings.
- 1 watt-second = 1 joule

Discussions follow of the data and equations used in Battery and Memory Endurance; use this information to perform your own calculations if desired.

**Battery Endurance – with Quartz Pressure Sensor**

- **Tide sample**

If (tide duration < tide interval – 20 sec), the SBE 26plus goes to sleep between tide measurements, drawing only quiescent power (0.0005 watt) while *sleeping*.

*If sleeping between tide samples (tide duration < tide interval – 20 sec)*

Quiescent = 0.0005 watt \* (tide interval – tide duration – 10 sec – 2 sec)

Pressure sensor integration = 0.01 watt \* (tide duration + 10 sec)

Turn-on for each sample = 0.30 watt-sec

Tide sample (including temperature) = 0.30 watt-sec

Conductivity sample = 0.40 watt-sec

*If not sleeping between tide samples (tide interval = tide duration)*

Pressure sensor integration = 0.01 watt \* tide duration

Tide sample (including temperature) = 0.30 watt-sec

Conductivity sample = 0.40 watt-sec

- **Wave burst measurement**

Wave burst duration

= [number of wave samples \* wave sample duration (sec)]

Wave burst = 0.11 watt \* wave burst duration (sec)

Real-time wave statistics =

0.2 Wwatts \* 0.06 sec/sample \* real-time statistics samples/burst

*Example: 26plus with quartz pressure sensor, conductivity sensor, and standard alkaline batteries. Measure tides every 60 minutes (24 measurements/day), with measurement duration of 120 seconds. Measure waves after every 6 tide samples (24 / 6 = 4 wave bursts/day). Take 4096 wave measurements per burst, at 0.25-second integration time per measurement. Do not output real-time wave statistics. (Note: This is same sampling scheme as shown in Battery and Memory Endurance dialog box above.)*

**Tide sample:**

26plus is sleeping between samples because *tide duration < tide interval – 20 seconds* (120 < 3600 – 20)

Pressure integration = 0.01 watt \* (120 sec + 10 sec) = 1.3 joules/measurement

Turn-on = 0.30 joules/measurement

Tide sample (including temperature) = 0.30 joules/measurement      Conductivity sample = 0.4 joules/measurement

Quiescent between samples = 0.0005 watt \* (3600 sec – 120 sec – 10 sec – 2 sec) = 1.74 joules /measurement

(Note: This provides a small over-estimate of quiescent power, because quiescent time is reduced during each tide interval that includes a wave burst.)

Tide power/measurement = 1.3 + 0.3 + 0.3 + 0.4 + 1.74 = 4.04 joules/measurement

Total tide power/day = 4.04 joules/measurement \* 24 measurements/day = **97.0 joules/day**

**Wave sample:**

Wave burst duration = 0.25 seconds \* 4096 measurements = 1024 seconds/burst

Wave burst = 0.11 watt \* 1024 seconds/burst = 112.64 joules/burst

Total wave power/day = 112.64 joules/burst \* 4 bursts/day = **450.6 joules/day**

Alkaline battery capacity = 756,000 joules \* 0.85 (derate for safety) = 642,600 joules

Derating 5% per year for battery self-discharge: 0.05 \* 642,600 joules / 365 days per year = **88 joules/day**

**Total power consumption** = 97.0 joules/day + 450.6 joules/day + 88 joules/day = **635.6 joules/day**

Number of days of battery capacity = 642,600 joules/ 635.6 joules/day = **1011 days** = 2.77 years

As a check, compare with the output of Battery and Memory Endurance on the 26plus-Quartz tab; the program shows the same results. Although the battery capacity is 2.77 years, the program provides a warning that deployments longer than 2 years are not recommended with alkaline batteries. Additionally, the program calculated that the memory endurance is only 676 days (1.85 years), which is the limiting factor in deployment length for this sampling scheme (see *Memory Endurance* for example calculation).

## Battery Endurance – with Strain Gauge Pressure Sensor

**Note:**

1 watt-second = 1 joule

- Tide sample (for intervals *without* a wave burst)**  
 Quiescent = 0.0005 watt \* (tide interval – tide duration – 2.6 sec)  
 Turn-on/off for each tide sample = 0.36 watt-sec  
 Tide sample (including temperature) = 0.14 watt \* tide duration  
 Conductivity sample = 0.71 watt-sec
- Tide sample + Wave burst (for intervals *with* a wave burst)**  
 Wave burst duration = [number of wave samples \* wave sample duration (sec)]  
 Conductivity sample = 0.71 watt-sec  
 Real-time wave statistics =  
     0.2 watts \* 0.06 sec/sample \* real-time statistics samples/burst  
  
*If (tide duration + wave duration + 5 < tide interval)*  
 Quiescent =  
     0.0005 watt \* (tide interval – tide duration - wave duration – 2.6 sec)  
 Turn-on/off for each tide sample = 0.36 watt-sec  
 Tide (including temperature) and wave sample (watt-sec) =  
     0.14 watt \* [tide duration (sec) + wave duration (sec)]  
  
*If (tide duration + wave duration + 5 ≥ tide interval)*  
 Turn-on/off for each tide sample = 0.36 watt-sec  
 Tide (including temperature) **and** wave sample =  
     0.14 watt \* wave duration (sec)

*Example:* 26plus with strain gauge pressure sensor, conductivity sensor, and standard alkaline batteries. Measure tides every 60 minutes (24 measurements/day), with measurement duration of 120 seconds. Measure waves after every 6 tide samples (24 / 6 = 4 wave bursts/day). Take 4096 wave measurements per burst, at 0.25-second integration time per measurement. Output real-time wave statistics on 512 of the 4096 wave measurements/burst.

**Tide sample (for intervals *without* a wave burst):**

Quiescent between samples = 0.0005 watt \* (3600 sec – 120 sec – 2.6 sec) = 1.74 joules /measurement  
 Turn-on = 0.36 joules/measurement  
 Take tide sample = 0.14 watt \* 120 seconds = 16.80 joules/measurement  
 Take conductivity sample = 0.71 joules/measurement  
 Tide power/measurement = 1.74 + 0.36 + 16.80 + 0.71 = 19.61 joules/measurement  
 # of tide measurements/day without a wave burst = 24 measurements/day – 4 wave bursts/day = 20 measurements/day  
 Total tide power/day = 19.61 joules/measurement \* 20 measurements/day = **392.2 joules/day**

**Tide sample + Wave sample (for intervals *with* a wave burst):**

Wave burst duration = 0.25 seconds \* 4096 measurements = 1024 seconds/burst  
 Tide duration + wave duration + 5 = 120 + 1024 + 5 = 1149 seconds < tide interval = 3600 seconds  
 Quiescent between samples = 0.0005 watt \* (3600 sec – 120 sec – 1024 sec – 2.6 sec) = 1.23 joules /measurement  
 Turn-on = 0.36 joules/measurement  
 Take tide and wave sample = 0.14 watt \* (120 sec + 1024 sec) = 160.2 joules/measurement  
 Take conductivity sample = 0.71 joules/measurement  
 Tide and wave power/measurement = 1.23 + 0.36 + 160.2 + 0.71 = 162.5 joules/measurement  
 Total tide and wave power/day = 162.5 joules/measurement \* 4 measurements/day = **650 joules/day**

**Real-time wave statistics**

Power consumption (watt-sec) = 0.2 watts \* 0.06 sec/sample \* 512 samples/burst = 6.14 joules/wave burst  
 Total statistics/day = 6.14 joules/wave burst \* 4 wave bursts/day = **24.6 joules/day**

Alkaline battery capacity = 756,000 joules \* 0.85 (derate for safety) = 642,600 joules

Derating 5% per year for battery self-discharge: 0.05 \* 642,600 joules / 365 days per year = **88 joules/day**

**Total power consumption** = 392 joules/day + 650 joules/day + 25 joules/day + 88 joules/day = **1155 joules/day**

Number of days of battery capacity = 642,600 joules / 1155 joules/day = **556 days** = 1.52 years

As a check, compare with the output of Battery and Memory Endurance on the 26plus-Strain tab; the program shows the same results. The program calculated that the memory endurance is 676 days (1.85 years), which is not the limiting factor in deployment length for this sampling scheme (see *Memory Endurance* for example calculation).

## Memory Endurance

The SBE 26plus comes standard with a 32 MB memory. Memory used for storing logged data is:

$$\begin{aligned} \text{If conductivity is \textbf{not} enabled:} & \quad \text{Bytes/day} = 9N + W (36 + 3M) \\ \text{If conductivity \textbf{is} enabled:} & \quad \text{Bytes/day} = 12N + W (48 + 3M) \end{aligned}$$

where

N = number of tide samples/day

W = number of wave bursts/day

M = number of wave measurements/burst

*Example: 26plus with conductivity sensor.*

Measure tides every 60 minutes (1/hour \* 24 hours = 24 measurements/day). Measure waves after every 6 tide samples (24 / 6 = 4 wave bursts/day). Take 4096 wave measurements per burst.

(Note: This is same sampling scheme as shown in Battery and Memory Endurance dialog box above, and in power endurance calculation examples.)

$$N = 24, W = 4, M = 4096$$

$$\text{Bytes/day} = 12N + W (48 + 3M) = (12 * 24) + 4 * (48 + 3 * 4096) = 49,632 \text{ bytes/day}$$

$$\text{Memory capacity} \approx 32 \text{ MB} * 1024 * 1024 = 33,554,432 \text{ bytes}$$

$$\text{Memory endurance} \approx 33,554,432 / 49,632 = 676 \text{ days}$$

As a check, compare with the output of Battery and Memory Endurance; the program shows the same results.

Note that for this example the 26plus power capacity exceeds the memory capacity.



# Section 5: SBE 26plus Setup, Installation, and Data Upload - SeatermW

## Note:

Instrument commands and responses are identical for the 26plus with Quartz pressure sensor or Strain Gauge pressure, **except as noted**.

This section covers:

- Programming the SBE 26plus for deployment using SeatermW
- Command descriptions
- Programming the SBE 26plus for use only as a tide recorder or only as a wave recorder
- Installing and deploying the SBE 26plus
- Recovery and uploading data from memory using SeatermW

## Programming for Deployment - SeatermW

1. Connect the 26plus to the computer using the data I/O cable:
  - A. By hand, unscrew the locking sleeve from the 26plus I/O connector (4-pin for standard RS-232; 6-pin for optional RS-422 / RS-485). If you must use a wrench or pliers, be careful not to loosen the I/O connector instead of the locking sleeve.
  - B. Remove the dummy plug from the 26plus I/O connector by pulling the plug firmly away from the connector.
  - C. **Standard Connector** - Install the Sea-Bird I/O cable connector, aligning the raised bump on the side of the connector with the large pin (pin 1 - ground) on the 26plus. **OR**  
**MCBH Connector** – Install the cable, aligning the pins.
  - D. Connect the I/O cable connector to your computer's serial port.
2. In SEASOFT for Waves Run menu, select SeatermW.  
The main screen looks like this:

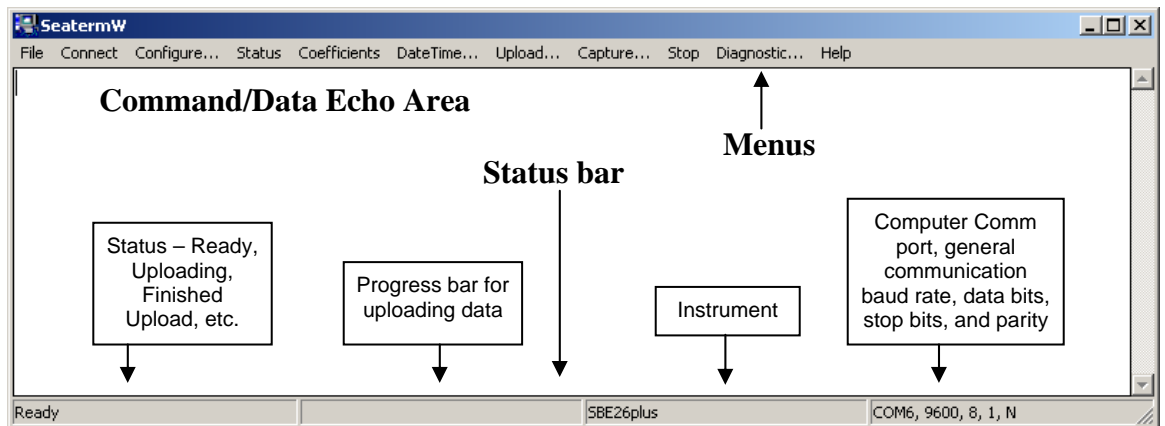

## Note:

Once the system is configured and connected (Steps 3 and 4 below), to update the Status bar, click Status. SeatermW sends the status command (**DS**), which displays in the Command/Data Echo Area, and updates the Status bar.

- Menus – Contains tasks and frequently executed instrument commands.
- Command/Data Echo Area – Echoes a command executed using a Menu, as well as the 26plus response. Additionally, a command can be manually typed in this area, from the available commands for the 26plus. The 26plus must be *awake* for it to respond to a command (use Connect to wake up the 26plus).
- Status bar – Provides status information.

Following is a description of the menus:

**Note:**

You must be *connected* to the instrument (Connect) when using Status, Coefficients, Upload, Stop, or Diagnostic.

Menu	Description	Equivalent Command*
File	Exit SeatermW.	-
Connect	Re-establish communications with 26plus. Computer responds with S> prompt. 26plus goes to sleep after 2 minutes without communication from computer have elapsed.	(press Enter key)
Configure	Establish communication parameters (instrument, Comm port, and baud rate).	-
Status	Display 26plus setup and status (logging, samples in memory, etc.).	<b>DS</b>
Coefficients	Display pressure, temperature, and optional conductivity sensor calibration coefficients.	<b>DC</b>
DateTime	Set 26plus date and time based on time in computer. See <i>Setting Time in SBE 26plus to Synchronize Sampling of Multiple Instruments</i> for details.	<b>DateTime=x</b>
Upload	Upload data stored in memory, in format our data processing modules can use. Uploaded data has .hex extension. Before using, verify 26plus has stopped logging (send <b>Stop</b> unless you had input and enabled a pre-programmed stop time before beginning logging).	Upload with <b>DD</b> or <b>DBbaud,b,e</b> (use Upload if you will be processing data with SEASOFT for Waves)
Capture	Capture 26plus responses on screen to file; to save real-time data or may be useful for diagnostics. File has .cap extension. Click Capture again to turn off capture. Capture status displays in Status bar.	-
Stop	Interrupt and end current activity, such as uploading data or running diagnostic test (such as <b>FR</b> , <b>VR</b> , <b>TT</b> , <b>TTR</b> ). Note: This does not stop logging – use <b>Stop</b> command to stop logging.	(press Esc key several times)
Diagnostic	Perform diagnostic tests on 26plus. Tests are non-destructive – they do not write over any existing settings.	<b>DS</b> (status); <b>DC</b> (calibration coefficients); <b>DD0,10</b> (upload and display tide samples 0 – 10, along with wave burst data logged during that period of time); <b>FR</b> (display frequencies)

\*See *Command Descriptions* in this section.

**Note:**

SeatermW's general communication baud rate must be the same as the 26plus baud rate (set with **Baud=**). Baud is factory-set to 9600, but can be changed by the user (see *Command Descriptions*). Other communication parameters – 8 data bits, 1 stop bit, and no parity – cannot be changed.

3. Click Configure. The dialog box looks like this:  
Verify/modify the parameters in the Configuration dialog box. Click OK.

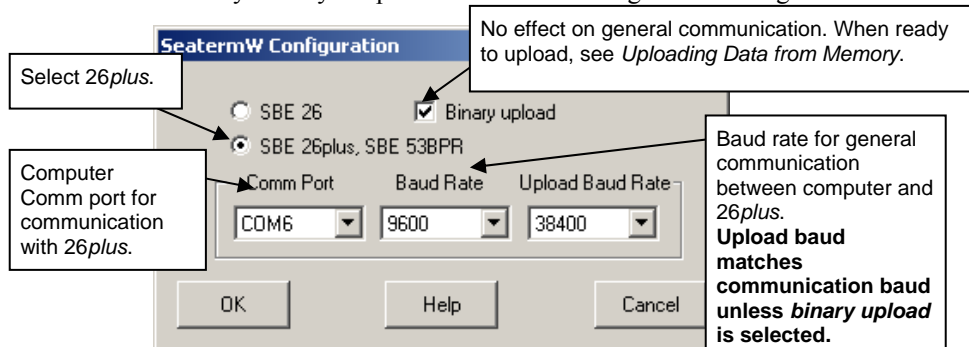

- Click Connect. The display looks like this:

```
SBE 26plus
S>
```

This shows that correct communications between the computer and *26plus* has been established.

If the system does not respond with the *S>* prompt:

- Click Connect again.
- Verify the correct instrument, Comm port, and baud rate were entered in the Configuration dialog box.
- Check cabling between the computer and *26plus*.

- Display *26plus* setup information by clicking Status; SeatermW sends the **DS** command. The display looks like this:

**Note:**

The *26plus* automatically enters quiescent (sleep) state after 2 minutes without receiving a command. This timeout algorithm conserves battery energy if the user does not send **QS** to put the *26plus* to sleep. If the system does not appear to respond, click Connect to reestablish communications.

```
SBE 26plus V 6.1c SN 12345 10 Dec 2006 13:35:13
user info=test setup
quartz pressure sensor: serial number = 90319, range = 1000 psia
internal temperature sensor
conductivity = YES
iop = 6.0 ma vmain = 15.3 V vlith = 9.3 V
last sample: p = 21.9520, t = 21.0250, s = 34.3799

tide measurement: interval = 60.000 minutes, duration = 120 seconds
measure waves every 6 tide samples
4096 wave samples/burst at 4.00 scans/sec, duration = 1024 seconds
logging start time = do not use start time
logging stop time = do not use stop time

tide samples/day = 24.000
wave bursts/day = 4.000
memory endurance = 676.1 days
nominal alkaline battery endurance = 1011.3 days
deployments longer than 2 years are not recommended with
alkaline batteries
total recorded tide measurements = 0
total recorded wave bursts = 0
tide measurements since last start = 0
wave bursts since last start = 0

transmit real-time tide data = YES
transmit real-time wave burst data = YES
transmit real-time wave statistics = NO

status = stopped by user
logging = NO, send start command to begin logging
```

- Send the desired commands to set up the *26plus* (see *Command Descriptions* below). Verify the setup by clicking Status again.

7. Test the setup by typing **Start** and pressing the Enter key to begin logging.

**Notes:**

- See *Appendix II: Sample Timing* for a detailed description of when tide and wave measurements are made and stored in memory.
- When transmitting real-time tide data, each tide measurement record displays **after** the tide duration is complete. For example, if the tide duration is 10 minutes, the first tide data displays 10 minutes after logging starts.

If the **DS** response shows logging start time = do not use start time (*use start time?* in **SetSampling** prompt is *No*), the 26plus responds:

logging will start in 10 seconds

If the **DS** response shows transmit real-time tide data = YES (real-time tide data was enabled with **TxTide=Y**), each time the 26plus completes a tide measurement, the display looks like this:

```
Tide: start time = 26 Jan 2006 13:40:01, p =14.2135,
pt = 21.952, t = 21.0250, c = 4.81952, s = 34.3799
```

where:

- start time = start of tide measurement.
- p = calculated and stored pressure (psia).
- pt = calculated pressure temperature (not stored) (°C).
- t = calculated and stored temperature (°C).
- c = calculated and stored conductivity (S/m) and s = calculated salinity (not stored) (psu).

Note that c and s display only if **DS** response shows conductivity = YES (conductivity acquisition is enabled with **Conductivity=Y**).

If the **DS** response shows transmit real-time wave burst data = YES (real-time wave data transmission was enabled with **TxWave=Y**), each time a wave burst measurement is made, the display looks like this:

```
wave: start time = 26 Jan 2006 13:43:13
wave: ptfreq = 172046.343      or      wave: ptRaw = 1.278
14.5599
14.5598
14.5597
. . .
14.5598
wave: end wave burst
```

where:

- start time = start of wave measurement.
- ptfreq = pressure temperature frequency (Hz); displays only for 26plus with Quartz pressure sensor.
- ptRaw = calculated pressure temperature number; displays only for 26plus with Strain Gauge pressure sensor.
- Remaining displayed values are calculated and stored pressures (psia).

**Note:**

This wave data was obtained while the instrument was on land, so the output is indicating essentially 0 wave height.

If the **DS** response shows transmit real-time wave statistics = YES (real-time wave statistics was enabled with TXWAVESTATS=Y in the **SetSampling** command prompt), each time a wave burst is completed, the display looks like this (if Show progress messages = n):

Auto-Spectrum Statistics:

```
nAvgBand = 5
total variance = 1.7509e-08
total energy = 1.7137e-04
significant period = 4.2667e+01
significant wave height = 5.2928e-04
```

Time Series Statistics:

```
Wave integration time = 128
Number of waves = 0
Total variance = 1.6868e-08
Total energy = 1.6512e-04
Average wave height = 0.0000e+00
Average wave period = 0.0000e+00
Maximum wave height = 5.9477e-04
Significant wave height = 0.0000e+00
Significant wave period = 0.0000e+00
H1/10 = 0.0000e+00
H1/100 = 0.0000e+00
```

**Note:**

See *Appendix VI: Wave Theory and Statistics* for a description of calculation of wave statistics.

where:

- Auto-Spectrum Statistics -  
nAvgBand = user-input number of spectral estimates for each frequency band, and  
next 4 lines are calculated (not stored) auto-spectrum statistics
- Time Series Statistics -  
wave integration time (sec) = wave burst duration  
= user input number of samples / burst \* sample duration, and  
remaining lines are calculated (not stored) time series statistics

8. End the test by typing **Stop** and pressing the Enter key to stop logging. You may need to press the Esc key before entering **Stop** to get the 26plus to stop if it is in the middle of sampling. Verify that logging has stopped by clicking Status and checking that the last line of the **DS** response shows logging = no.
9. (if ready for deployment)
  - A. Type **InitLogging** and press the Enter key to make the entire memory available for recording. If **InitLogging** is not sent, data will be stored after the last recorded sample.
  - B. To begin logging now: Type **Start** and press the Enter key. The 26plus should display:  
logging will start in 10 seconds.
  - C. To begin logging at a delayed start date and time:
    - Type **SetStartTime**, press the Enter key, and respond to the prompts to establish a delayed start date and time.
    - Type **SetSampling** and press the Enter key, and answer yes to the *use start time?* prompt to enable logging at the delayed start date and time.
    - Type **Start** and press the Enter key. The 26plus should display:  
logging will start at . . . .
10. (if not ready for deployment) Type **QS** and press the Enter key to command the 26plus to go to sleep (quiescent state).

## Command Descriptions

This section describes commands and provides sample outputs.  
See *Appendix I: Command Summary* for a summarized command list.

### General Command Notes

- Input commands in upper or lower case letters and register commands by pressing the Enter key.
- The 26plus sends ? CMD if an invalid command is entered.
- If the 26plus does not return an S> prompt after executing a command, press the Enter key to get the S> prompt.
- If a new command is not received within 2 minutes after completion of a command, the 26plus returns to quiescent (sleep) state and the display indicates time out.
- If in quiescent state, re-establish communications by clicking Connect or pressing the Enter key to get an S> prompt.
- The 26plus cannot have samples with different tide sample scan lengths (more or fewer data fields per sample) in memory. If the scan length is changed, the 26plus must initialize logging. Initializing logging sets the tide sample number and wave sample number to 0, so the entire memory is available for recording data with the new scan length. **Initializing logging should only be performed after all previous data has been uploaded.** Conductivity=, which enables/disables acquisition and storing of optional conductivity data, changes the scan length. Therefore, Conductivity= prompts the user for verification before executing, to prevent accidental overwriting of existing data.
- The 26plus does not respond at all while making a wave burst measurement. If you need to establish communications during a wave burst, press the Esc key or click Stop to interrupt the wave burst (this interrupts the current wave burst but does not stop logging). The 26plus will fill out the remaining data in the interrupted wave burst with 0's.
- **26plus with Quartz Pressure Sensor:** The 26plus responds only to **DS**, **DC**, **QS**, **SL**, **SLO**, and **Stop** while making a tide measurement. If you wake up the 26plus while it is logging (for example, to send **DS** to check on logging progress), it does not interrupt logging.
- **26plus with Strain Gauge Pressure Sensor:** The 26plus does not respond at all while making a tide measurement. If you need to establish communications during a tide measurement, press the Esc key or click Stop to interrupt the tide measurement (this interrupts the current tide measurement but does not stop logging). If you are communicating/requesting data (for example, sending **DS**, **QS**, **SL**, or **SLO**) from the 26plus when it should be starting the next tide measurement, it delays the start of the next tide measurement. **If feasible** (depending on the value of tide duration and tide interval), the 26plus makes the following tide interval shorter to return the time series to the expected timing. For example, if the tide interval is 1 minute, tide sample start times are:  
10:20:15  
10:21:15  
10:22:25 (26plus delayed sample because user sent **DS**)  
10:23:15 (26plus made interval shorter to return to expected timing)  
10:24:15

#### Note:

Interrupting a wave burst and/or tide measurement by pressing the Esc key or clicking Stop will affect the quality of your data. For high quality data, Sea-Bird recommends the following to allow querying the 26plus during logging without interrupting measurements:

- Set sampling parameters with enough time between measurements, and
- Schedule/time queries when the 26plus is not measuring tides (of concern only for 26plus with Strain Gauge pressure sensor) or waves.

- The 26*plus* responds only to **DS**, **DC**, **QS**, and **Stop** while *waiting to start logging* (*use start time?* prompt in **SetSampling** command is *Yes*, and **Start** was sent, but sampling has not started yet).  
To send any other commands:
  1. Send **Stop**.
  2. Send the desired commands to modify the setup.
  3. Send **Start** again.
- Click Upload to upload data that will be processed by SEASOFT for Waves. Manually entering a data upload command does not produce data with the required header information for SEASOFT for Waves.
- If the 26*plus* is uploading data and you want to stop it, press the Esc key or click Stop. Press the Enter key to get the S> prompt.

Entries made with the commands are permanently stored in the 26*plus* and remain in effect until you change them.

- The only exception occurs if the electronics are removed from the housing and the two PCBs are separated or the lithium jumper (JP7) is removed (see *Appendix IV: Electronics Disassembly/Reassembly*). Before beginning disassembly, upload all data in memory. Upon reassembly, reset the date and time (**SetTime**) and initialize logging (**InitLogging**).

## Commands

### Status Command

#### DS

##### Notes:

- With Quartz pressure sensor:  
You can wake up the 26plus during a tide measurement and display status (press Enter key to get S>, then click Status) without interrupting logging.
- With Strain Gauge pressure sensor:  
Waking up the 26plus during a tide measurement and displaying status interrupts logging. See *General Command Notes* above.

##### Note:

- **Memory** endurance is based on *total* memory capacity, taking into account the setup (tide measurement interval, wave burst interval, etc), but not considering the measurements already in memory.
- **Battery** endurance is based on *original*, nominal alkaline battery capacity, taking into account the setup (tide measurement interval, wave burst interval, etc). It is not based on a measurement of remaining battery voltage or the number of measurements already taken. If calculated battery endurance is greater than 730 days, status response shows deployments longer than 2 years are not recommended with alkaline batteries.

Memory and battery endurance output with **DS** matches that calculated in Battery and Memory Endurance (but Battery and Memory Endurance outputs lithium battery endurance as well as alkaline). See *Section 4: Pre-Deployment Planning – Plan Deployment and Battery and Memory Endurance*.

##### Note:

After sending **Start**, logging status should be one of the following if the 26plus is operating correctly:

- logging started - if **use start time** in **SetSampling** prompt is **No** (26plus started logging 10 seconds after receipt of **Start**).
- waiting to start at . . . - if **use start time** in **SetSampling** prompt is **Yes** (26plus waits to start logging at time set with **SetStartTime**).

Display operating status and setup parameters. Equivalent to Status menu.

List below includes, where applicable, command used to modify parameter.

- Firmware version, serial number, date and time [**SetTime** or **DateTime**=]
- User-input description [**UserInfo**=]
- Pressure sensor type (quartz or strain gauge), serial number, and full scale range
- Enable high-accuracy external thermistor [**ExternalTemperature**=]?
- Enable conductivity sensor [**Conductivity**=]?
- Main operating current, main and back-up lithium battery voltages
- Last measured pressure (psia) and temperature (°C); calculated salinity (only if conductivity enabled, psu)
- Wave and tide sampling setup [**SetSampling**]:
  - Interval between tide samples and tide sample duration
  - Interval between wave bursts
  - Number of wave measurements/burst, wave sampling frequency, and calculated wave sampling duration
  - Start time for logging (if enabled)
  - Stop time for logging (if enabled)
- Calculated number of tide samples/day [based on **SetSampling**]
- Calculated number of wave bursts/day [based on **SetSampling**]
- Calculated memory endurance [based on **SetSampling**]
- Calculated battery endurance [based on **SetSampling**]
- Number of tide measurements in memory
- Number of wave bursts in memory
- Number of tide measurements since logging was last started
- Number of wave bursts since logging was last started
- Transmit real-time tide data [**TxTide**=]?
- Transmit real-time wave data [**TxWave**=]?
- Transmit real-time wave statistics [**SetSampling**]? If yes, real-time wave statistic settings, entered with **SetSampling**, display.
- Logging status is one of following:
  - never started, waiting to start at . . . , logging started, stop: out of memory, stop: low battery, stop time reached, stopped by user, unknown
- Logging is one of following:
  - NO, send start command to begin logging (if **Start** has not been sent)
  - YES (if **Start** has been sent and 26plus is currently logging)
  - YES, waiting to start (if **Start** has been sent but 26plus is programmed to start logging at a future date/time)



**Status Command (continued)**

*Example:* (user input in bold; parameter used to change value in parentheses).

```

S>DS
SBE 26plus V 6.1c SN 12345 10 Dec 2006 13:35:13 [SetTime or DateTime=]
user info=test setup [UserInfo=]
quartz pressure sensor: serial number = 90319, range = 1000 psia
internal temperature sensor [ExternalTemperature=]
conductivity = NO [Conductivity=]
iop = 6.0 ma vmain = 15.3 V vlith = 9.3 V
last sample: p = 14.3727, t = 2.924

tide measurement: interval = 60.000 minutes, duration = 120 seconds [SetSampling]
measure waves every 6 tide samples [SetSampling]
4096 wave samples/burst at 4.00 scans/sec, duration = 1024 seconds [SetSampling]
logging start time = 29 Jan 2006 00:00:00 (see Note 3) [SetSampling and SetStartTime]
logging stop time = 30 Jan 2006 00:00:00 [SetSampling and SetStartTime]

tide samples/day = 24.000 [based on SetSampling]
wave bursts/day = 4.000 [based on SetSampling]
memory endurance = 676.1 days [based on SetSampling]
nominal alkaline battery endurance = 1026.8 days [based on SetSampling]
deployments longer than 2 years are not recommended with alkaline batteries (see Note 1)
total recorded tide measurements = 0
total recorded wave bursts = 0
tide measurements since last start = 0
wave bursts since last start = 0

transmit real-time tide data = YES [TxTide=]
transmit real-time wave burst data = YES [TxWave=]
transmit real-time wave statistics = NO (see Note 2) [SetSampling]

status = stopped by user (see Note 3)
logging = NO, send start command to begin logging

```

**Notes:**

1. Although calculated battery endurance for this example is 1026.8 days (2.81 years), Sea-Bird does not recommend planning deployments longer than 2 years with alkaline batteries.
2. If `transmit real-time wave statistics = YES`, following lines appear below it (all statistics parameters are entered with **SetSampling**):
 

```

number of wave samples per burst to use for wave statistics = 512
do not use measured temperature and conductivity for density calculation
average water temperature above the pressure sensor (deg C) = 15.0
average salinity above the pressure sensor (PSU) = 35.0
height of pressure sensor from bottom (meters) = 0.0
number of spectral estimates for each frequency band = 5
minimum allowable attenuation = 0.0025
minimum period (seconds) to use in auto-spectrum = 0.0e+00
maximum period (seconds) to use in auto-spectrum = 1.0e+06
hanning window cutoff = 0.10
show progress messages

```
3. You must send **Start** to start logging at programmed start time. After you send **Start**, status line should show:
 

```

status = waiting to start at 29 Jan 2006 00:00:00

```

---

**General Setup Commands**

---

**SetTime** Set real-time clock date and time.  
26plus prompts for desired date and time.

*Example:* Set current date and time to 31 January 2006 12:35:00 (user input in bold).

```
S>SETTIME
set current time:
month (1 - 12) = 1
day (1 - 31) = 31
year (4 digits) = 2006
hour (0 - 23) = 12
minute (0 - 59) = 35
second (0 - 59) = 0
```

**DateTime=x** x= real-time clock date and time (mmddyyyyhhmmss). Command is sent automatically when using SeatermW's DateTime menu. DateTime menu provides greater accuracy in setting time than can be achieved with **SetTime**; this may be important for synchronizing sampling among multiple instruments. See *Setting Time in SBE 26plus to Synchronize Sampling of Multiple Instruments*.

**Note:**

The 26plus baud rate for general communication (set with **Baud=**) must be the same as SeatermW's baud rate (set in the Configure menu).

**Baud=x** x= baud rate for general communication (600, 1200, 2400, 4800, 9600, 19200, or 38400). Default 9600.

**ExternalTemperature=x** x=**Y**: 26plus has optional high-accuracy external thermistor.

x=**N**: 26plus has standard internal thermistor. Default.

**Conductivity=x** x=**Y**: Enable conductivity logging (if 26plus has optional SBE 4M conductivity sensor).

x=**N**: Disable conductivity logging.

**Note:**

When **Conductivity=** is sent, the 26plus must initialize logging, setting tide and wave sample numbers to 0, so the entire memory is available for recording data with the new scan length. **This should only be done after all previous data has been uploaded.** Therefore, the 26plus requires verification when **Conductivity=** is sent; the 26plus responds: this command will change the scan length and initialize FLASH memory. Proceed Y/N? Press Y and the Enter key to proceed.

**UserInfo=x** x= user-defined string that displays in status (**DS**) reply. Up to 59 characters (including spaces); 26plus drops any characters after 59. No carriage returns allowed. Allows user to include information describing deployment, conditions, etc. as permanent part of data set, because **DS** reply is included in uploaded .hex file when SeatermW's Upload is used to upload data (see *Uploading Data from Memory*).

**General Setup** Commands (*continued*)**Notes:**

- SEASOFT for Waves data processing modules cannot process real-time tide or wave data from the 26plus.
- **TxWave=Y does not control output of real-time wave statistics.** To output real-time wave statistics, use **SetSampling** and respond to the TXWAVESTATS prompt with Y.

**TxTide=x**

**x=Y:** Transmit real-time tide data while logging. Does not affect storing data to memory. 26plus transmits tide measurement start time, pressure (psia), pressure temperature (°C), and temperature (°C). If **Conductivity=Y**, it also transmits conductivity (S/m) and salinity (psu).

**x=N:** Do not transmit real-time tide data.

**TxWave=x**

**x=Y:** Transmit real-time wave data while logging. Does not affect storing data to memory. 26plus transmits wave burst start time, pressure temperature frequency (Quartz pressure) or pressure temperature number (Strain Gauge pressure), and pressures (psia).

**x=N:** Do not transmit real-time wave data.

**QS**

Quit session and place 26plus in quiescent (sleep) state. Main power is turned off. Memory retention is not affected.

**Note:**

Drawing is schematic only, intended to define the sampling scheme terminology. See *Appendix II: Sample Timing* for timing details.

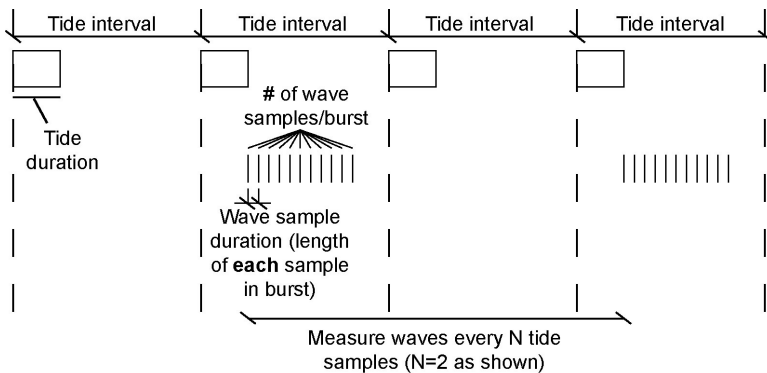
**Wave and Tide Setup Command****SetSampling**

Set sampling parameters. *26plus* displays present value and asks for new value for each parameter. Type in desired value and press Enter key. To accept present value without change, press Enter key. *26plus* prompts as follows:

**Notes:**

- An alternate form for this command is **SetSample**; both have the same function.
- If only interested in tide data, see *Using SBE 26plus as a Tide Recorder* for guidelines.
- If only interested in wave data, see *Using SBE 26plus as a Wave Recorder* for guidelines.
- With Quartz pressure sensor: Time required for each wave burst (= wave samples/burst \* wave sample duration + time for real-time statistics calculation) must be < (tide interval - 20 sec). If the setup does not meet this requirement, the *26plus* increases the tide interval to meet the requirement.
- With Strain Gauge pressure sensor: Time required for each wave burst (number of wave samples/burst \* wave sample duration) must be < (tide interval - 10 sec). If the setup does not meet this requirement, the *26plus* increases the tide interval to meet the requirement.
- See *Appendix II: Sample Timing* for a detailed description of when tide and wave measurements are made.

**tide interval (integer minutes) = 30, new value =**

Time from start of tide measurement to start of next tide measurement. Range 1 - 720 minutes (12 hours); user-input outside range is set to minimum or maximum allowable value, as appropriate.

**tide measurement duration (seconds) = 30, new value =**

Length of tide measurement (*26plus* integrates over this time, counting signal continuously and computing average pressure). Range 10 - 43,200 sec (12 hours).

**With Quartz pressure:**

If tide duration < (tide interval - 20 sec), *26plus* goes to sleep between tide samples and wakes up and latches power onto pressure sensor 10 sec before start of next tide sample.

If tide duration > (tide interval - 20 sec), tide duration is set to tide interval, and *26plus* samples tides continuously.

**With Strain Gauge pressure:** *26plus* always goes to sleep between measurements.

If tide duration > (tide interval - 10 sec), tide duration is set to (tide interval - 10 sec).

**measure wave burst after every N tide samples: N = 4, new value =**

Wave burst is sampled every (N \* tide interval). Range 1 - 10,000.

**number of wave samples per burst (multiple of 4) = 512, new value =**

Number of measurements/wave burst. If entered number is not multiple of 4, *26plus* rounds down to make it multiple of 4. Range 4 - 60,000. **To calculate wave statistics on uploaded data, Sea-Bird recommends following for meaningful, valid results:**  
 -- wave samples/burst ≥ 512, and  
 -- wave samples/burst = power of 2 (512, 1024, etc.).

**Note:**

Since a minimum of 512 samples/burst is **required** for **real-time** wave statistics calculations, and this must be ≤ total number of samples/burst, the *26plus* resets the total number of wave samples/burst to 512 if:

- a smaller number is entered, **and**
- real-time wave statistics is enabled (see `TXWAVESTATS` prompt below).

**wave sample duration (0.25, 0.5, 0.75, 1.0 seconds) = 1, new value =**

This parameter can be used to reduce wave burst sampling rate and increase integration time per measurement.

**Wave and Tide Setup** Command (*continued*)

*use start time (y/n) = n, new value =*

If yes, 26plus responds to **Start** by starting logging at date and time set with **SetStarttime**.

If no, 26plus starts logging 10 seconds after **Start** is sent.

*use stop time (y/n) = n, new value =*

If yes, 26plus stops logging at date and time set with **SetStopTime**.

If no, 26plus continues logging until **Stop** is sent.

*TXWAVESTATS (real-time wave statistics) (y/n) = n, new value =*

If yes, 26plus calculates and outputs real-time wave auto spectrum statistics (total variance, total energy, significant period, significant wave height) and time series statistics (number of waves, total variance, total energy, average wave height, average wave period, maximum wave height, significant wave height, significant wave period, H1/10, and H1/100) at the end of every wave burst. Does not affect storing data to memory.

*The remaining prompts apply to real-time wave statistics*

Following prompts appear only if you enter Y for TXWAVESTATS, and *only apply to real-time wave statistics*.

*Show progress messages (y/n) = y, new value =*

If yes, 26plus outputs progress messages as it performs real-time calculations.

*Number of wave samples per burst to use for wave statistics = 512, new value =*

Entered value must meet following:

$\geq 512$ . If entered number does not meet this criterion, 26plus sets it to 512.

$=$  power of 2 (512, 1024, etc.). If entered number does not meet this criterion, 26plus rounds down to nearest power of 2.

$\leq$  total number of wave samples/burst.

If entered number does not meet this criterion, 26plus rounds down to nearest power of 2 that is less than total number of wave samples/burst.

26plus calculates real-time statistics on samples at beginning of burst (for example, if set up for 4096 samples/burst and real-time statistics on 512 samples/burst, 26plus uses first 512 out of 4096 samples in real-time calculations).

**Notes:**

- Wave statistics can also be calculated on uploaded data using the Process Wave Burst Data module in SEASOFT for Waves. The real-time wave statistics parameter values entered with **SetSampling** are not used in Process Wave Burst Data.
- See *Section 8: Wave Data Processing – Process Wave Burst Data and Create Reports* and *Appendix VI: Wave Theory and Statistics* for details on wave statistic input parameters and calculations.

**Wave and Tide Setup** Command (*continued*)***Use measured temperature and conductivity for density calculation******(y/n) = n, new value =***

If Y, 26plus uses measured T and C to calculate density, which is used in wave statistics algorithm.

***Average water temperature above the pressure sensor (Deg C)******= 15.0, new value =******Average salinity above the pressure sensor (PSU) = 35.0,******new value =***

These 2 prompts appears only if you enter N for using measured T and C for density calculation. 26plus uses average water temperature and salinity to calculate density for wave statistics algorithm.

***Height of pressure sensor from bottom (meters) = 0.0,******new value =***

Height of pressure sensor from bottom affects attenuation and calculation of fmax (frequencies &gt; fmax are not processed).

***Number of spectral estimates for each frequency band = 5,******new value =***You may have used Plan Deployment to determine desired value; see *Section 4: Pre-Deployment Planning – Plan Deployment and Battery and Memory Endurance*.***Minimum allowable attenuation = 0.0025, new value =******Minimum period (seconds) to use in auto-spectrum = 0.0e+00,******new value =***

26plus defines high frequency cutoff, fmax, as smaller of:

-- frequency where (measured pressure / pressure at surface) &lt; (minimum allowable attenuation / wave sample duration).

-- (1 / minimum period).

Frequencies &gt; fmax are not processed.

***Maximum period (seconds) to use in auto-spectrum = 1.0e+06,******new value =***

Low frequency cutoff fmin =

(1 / maximum period).

Frequencies &lt; fmin are not processed.

***Hanning window cutoff = 0.10, new value =***

Hanning window suppresses spectral leakage that occurs when time series to be Fourier transformed contains periodic signal that does not correspond to one of exact frequencies of FFT.

Use **DS** to verify that 26plus is set up to sample as desired.

**Wave and Tide Setup Command (continued)**

**Example** (user input in bold): Set up 26plus with quartz pressure sensor to take 2-minute tide measurement (tide measurement duration = 120 seconds) every 60 minutes (tide interval = 60), measure waves after every 6 tide samples (wave burst after every N tide measurements = 6), and take 4096 wave samples per wave burst (wave samples/burst = 4096) at 1 sample per 0.25 second (wave sample duration = 0.25). Set up 26plus to start and stop sampling on command, rather than at pre-set start and stop times. Set up 26plus to output real-time wave statistics on 512 wave samples per burst. Then send **DS** to verify setup.

S>**SETSAMPLING**

```
tide interval (integer minutes) = 1, new value = 60
tide measurement duration (seconds) = 60, new value = 120
measure wave burst after every N tide samples: N = 3, new value = 6
number of wave samples per burst (multiple of 4) = 80, new value = 4096
wave sample duration (0.25, 0.50, 0.75, 1.0) seconds = 0.25, new value = 0.25
use start time (y/n) = y, new value = n
use stop time (y/n) = n, new value = n
TXWAVESTATS (real-time wave statistics) (y/n) = n, new value = y
the remaining prompts apply to real-time wave statistics
show progress messages (y/n) = n, new value = n
number of wave samples per burst to use for wave statistics = 512, new value = 512
use measured temperature and conductivity for density calculation (y/n) = y, new value = n
average water temperature above the pressure sensor (deg C) = 15.0, new value = 15.0
average salinity above the pressure sensor (PSU) = 35.0, new value = 35.0
height of pressure sensor from bottom (meters) = 0.0, new value = 0.0
number of spectral estimates for each frequency band = 5, new value = 6
minimum allowable attenuation = 0.0025, new value = 0.0025
minimum period (seconds) to use in auto-spectrum = 0.00e+00, new value = 0.00e+00
maximum period (seconds) to use in auto-spectrum = 1.00e+06, new value = 1.00e+06
hanning window cutoff = 0.10, new value = 0.10
```

S>**DS**

```
SBE 26plus V 6.1c SN 12345 10 Dec 2006 13:21:13
user info=test setup
quartz pressure sensor: serial number = 90319, range = 1000 psia
internal temperature sensor
conductivity = YES
iop = 6.0 ma vmain = 15.3 V vlith = 9.3 V
last sample: p = 21.9520, t = 21.0250, s = 34.3799

tide measurement: interval = 60.000 minutes, duration = 120 seconds
measure waves every 6 tide samples
4096 wave samples/burst at 4.00 scans/sec, duration = 1024 seconds
logging start time = do not use start time
logging stop time = do not use stop time

tide samples/day = 24.00
wave bursts/day = 4.00
memory endurance = 676.1 days
nominal alkaline battery endurance = 973.6 days
deployments longer than 2 years are not recommended with alkaline batteries
total recorded tide measurements = 0
total recorded wave bursts = 0
tide measurements since last start = 0
wave bursts since last start = 0

transmit real-time tide data = YES
transmit real-time wave burst data = YES
transmit real-time wave statistics = YES
real-time wave statistics settings:
  number of wave samples per burst to use for wave statistics = 512
  do not use measured temperature and conductivity for density calculation
  average water temperature above the pressure sensor (deg C) = 15.0
  average salinity above the pressure sensor (PSU) = 35.0
  height of pressure sensor from bottom (meters) = 0.0
  number of spectral estimates for each frequency band = 5
  minimum allowable attenuation = 0.0025
  minimum period (seconds) to use in auto-spectrum = 0.0e+00
  maximum period (seconds) to use in auto-spectrum = 1.0e+06
  hanning window cutoff = 0.10
  do not show progress messages

status = stopped by user
logging = NO, send start command to begin logging
```

**Initialize Logging (Reset Memory) Commands****Note:**

**Do not initialize logging until all data has been uploaded. InitLogging** does not delete data; it resets the data pointer. **If you accidentally initialize logging before uploading**, recover data as follows:

*For Standard ASCII Upload:*

1. Set **TideCount=a**, where **a** is your estimate of number of tide samples in memory.
2. Upload data. If **a** is more than actual number of tide samples, data for non-existent samples will be bad, random data. Review uploaded data carefully and delete any bad data.
3. If desired, increase **a** and upload data again, to see if there is additional valid data in memory.

*For Binary Upload:*

1. Set **\*ByteCount=a**, where **a** is your estimate of number of bytes in memory.
2. Upload data. If **a** is more than actual number of bytes, data for non-existent samples will be bad, random data. Review uploaded data carefully and delete any bad data.
3. If desired, increase **a** and upload data again, to see if there is additional valid data in memory.

**InitLogging**

Initialize logging - after all previous data has been uploaded, initialize logging before starting to sample again to make entire memory available for recording. **InitLogging** sets tide sample number and wave sample number to 0 internally. If not set to 0, data will be stored after last recorded sample. **Do not send InitLogging until all existing data has been uploaded.**

*The following two commands are typically used only if you accidentally initialize logging before uploading the data in memory.*

**TideCount=x**

**x**= sample number for first tide measurement when sampling begins. Use **TideCount=** to recover data if you accidentally initialize logging before uploading, and will be doing an ASCII upload.

**\*ByteCount=x**

**x**= byte number for first byte when sampling begins. Use **\*ByteCount=** to recover data if you accidentally initialize logging before uploading, and will be doing a binary upload.



---

**Logging Commands**

---

To start logging, send **Start**:

- If *Use start time?* in **SetSampling** prompt is *No*, logging starts approximately 10 seconds after receipt of **Start**.
- If *Use start time?* in **SetSampling** prompt is *Yes*, logging starts at the delayed time set with **SetStartTime**.

The first time logging starts after receipt of initialize logging (**InitLogging**), data recording starts at the beginning of memory and any previously recorded data is written over.

To stop logging:

- Send **Stop**, or
- Before starting logging, set a delayed stop time with **SetStopTime**, and set *Use stop time?* in **SetSampling** prompt to *Yes*.

Each time the 26plus is commanded to start logging again, recording continues, with new data stored after previously recorded data.

**Notes:**

- With Quartz pressure sensor: You can wake up the 26plus during a tide measurement and display status (press Enter key to get S>, then click Status) without interrupting logging.
- With Strain Gauge pressure sensor: You **cannot** wake up the 26plus during a tide measurement and display status. See *General Command Notes* above.
- You may need to send **Stop** several times to get the 26plus to respond.
- You must stop logging before uploading data.
- If *Use start time?* in the **SetSampling** prompt is *Yes*, and **SetStartTime** is less than 10 seconds in the future when **Start** is sent, the 26plus ignores the programmed start time and starts logging in 10 seconds.
- If *Use stop time?* in the **SetSampling** prompt is *Yes*, and **SetStopTime** is less than 1 hour after logging begins, the 26plus ignores the programmed stop time and continues logging until **Stop** is sent.
- See *Setting Time in SBE 26plus to Synchronize Sampling of Multiple Instruments* below to set multiple instruments to start logging at the same time.

**Start**

If *Use start time?* in **SetSampling** prompt is *No*: Start logging now (in approximately 10 seconds).

**OR**

If *Use start time?* in **SetSampling** prompt is *Yes*: Wait to start logging at time set with **SetStartTime**.

**Stop**

Stop logging.

**SetStartTime**

Set date and time to start logging. 26plus prompts you to enter desired date and time. Upon receipt of **Start**, 26plus waits to start logging at this date and time if *Use start time?* in **SetSampling** prompt is *Yes*.

**SetStopTime**

Set date and time to stop logging. 26plus prompts you to enter desired date and time. 26plus stops logging at this date and time if *Use stop time?* in **SetSampling** prompt is *Yes*.

**Logging Commands** (*continued*)

*Example 1:* Start and stop logging on command (user input in bold).

```
S>SETSAMPLING
. . . (Respond to prompts, changing tide and wave sampling setup as desired.)
use start time (y/n) = y, new value = n
use stop time (y/n) = y, new value = n
S>START
Logging will start in 10 seconds
```

(If **TxTide=Y**, tide data displays on screen. If **TxWave=Y**, wave data displays on screen.  
If TXWAVESTATS prompt in **SetSampling** command is Y, real-time wave statistics display on screen.  
See *Programming for Deployment - SeatermW* for a description of screen displays while logging.)

(To stop logging, press Enter key several times to get S> prompt.)

```
S>STOP
```

*Example 2:* Program 26plus to start logging on 20 May 2006 12:35:00 and stop logging on 21 May 2006 12:35:00 (user input in bold).

```
S>SETSAMPLING
. . . (Respond to prompts, changing tide and wave sampling setup as desired.)
use start time (y/n) = n, new value = y
use stop time (y/n) = n, new value = y
S>SETSTARTTIME
Set time to start logging:
Month (1-12) = 5
Day (1 - 31) = 20
Year (4 digits) =2006
Hour (0 - 23) = 12
Minute (0 - 59) = 35
Second (0 - 59) = 0
S>SETSTOPTIME
Set time to stop logging:
Month (1-12) = 5
Day (1 - 31) = 21
Year (4 digits) =2006
Hour (0 - 23) = 12
Minute (0 - 59) = 35
Second (0 - 59) = 0
S>START
Logging will start at 20 May 2006 12:35:00
Logging will stop at 20 May 2006 12:35:00
```

(When logging starts: If **TxTide=Y**, tide data displays on screen. If **TxWave=Y**, wave data displays on screen.  
If TXWAVESTATS prompt in **SetSampling** command is Y, real-time wave statistics display on screen.  
See *Programming for Deployment - SeatermW* for a description of screen displays while logging.)

(Logging stops at time set with **SetStopTime**.)

---

**Send Last Sample Commands**

---

**Note:**

See *General Command Notes* above for issues relating to sending commands while the 26plus is making a tide or wave measurement.

These commands cause the 26plus to transmit pressure, temperature, and salinity (if optional conductivity sensor installed) from the last tide measurement. These commands are functional only while the 26plus is logging (after **Start** has been sent to start logging now or at a future date/time).

- If **Start** has not been sent, the 26plus responds with ? CMD.
- If **Start** has been sent, but there is not yet a completed tide measurement in memory, the 26plus responds with:

p = -99.0000, t = -99.0000, s = -99.0000

**SL** Send pressure, temperature, and salinity (if optional conductivity sensor installed) data from last tide measurement and do not go to sleep (do not enter quiescent state).

**SLO** Send pressure, temperature, and salinity (if optional conductivity sensor installed) data from last tide measurement and go to sleep (enter quiescent state). Equivalent to sending **SL** and then sending **QS**.

*Example:* (user input in bold).

S>**SL**

p = 14.5266, t = 22.7003, s = 29.05335

---

**Data Upload Commands**

---

Stop logging before uploading data.

*ASCII Upload:*

**DD** Upload all data from memory **in ASCII** at baud rate set for general communication with **Baud=**.

*Binary Upload:*

Binary upload, useful for large data sets, is inherently faster than ASCII upload, because each byte is transmitted as one character instead of two. Additionally, the SBE 26plus supports binary upload at rates up to 115,200 baud, compared to ASCII upload at rates up to 38,400. SeatermW uploads the data in binary and then converts to ASCII, **resulting in a .hex file with the same format as from an ASCII upload.**

**DBbaud,b,e**

Upload data **in binary** at baud rate of **baud** (1200, 2400, 4800, 9600, 19200, 28800, 38400, 57600, or 115200) from byte **b** to byte **e**. First byte number is 0. 26plus can upload data in blocks of up to 500,000 bytes at one time. **Sending this command manually does not provide useful information.**

**ByteCount**

Display total number of bytes in memory.

**Notes:**

- Use SeatermW's Upload menu to upload data in ASCII or binary to a .hex file that will be processed by SEASOFT for Waves (see *Uploading Data from Memory* below). Manually entering **DD** or **DBbaud,b,e** does not produce data with the required header information for processing by SEASOFT for Waves. These commands are included here for reference for users who are writing their own software.
- To save manually uploaded data to a file, click Capture before entering the upload command.

**Note:**

When SeatermW's Upload menu is used for binary upload, SeatermW automatically tests that the selected upload baud rate is compatible with your computer, sends **ByteCount**, and sends **DBbaud,b,e** as many times as needed to upload all the data in memory in blocks of 500,000 bytes.

**Diagnostic Commands**

Data from these tests is not stored in FLASH memory.

**Note:**

Conductivity and salinity are output only if conductivity is enabled (**Conductivity=Y**).

**TS**

Take 1 sample of pressure, pressure temperature, temperature, and optional conductivity, and output **converted** data (pressure psia, pressure temperature °C, temperature °C, conductivity S/m, and salinity psu).

**TSR**

Take 1 sample of pressure, pressure temperature, temperature, and optional conductivity, and output **raw** data. Output varies, depending on pressure sensor type:

- Quartz pressure sensor: pressure frequency Hz, pressure temperature frequency Hz, temperature A/D counts, and conductivity frequency Hz.
- Strain Gauge pressure sensor: pressure A/D counts, pressure temperature number, temperature A/D counts, and conductivity frequency Hz.

**TT**

Sample temperature, and output **converted** data (°C). *26plus* runs continuously during test, drawing current. Press Esc key or click Stop to stop test.

**TTR**

Sample temperature, and output **raw** data (A/D counts). *26plus* runs continuously during test, drawing current. Press Esc key or click Stop to stop test.

**FR**

Measure and display frequencies (Hz).

Column	Output
1	<b>tf</b> = pressure frequency (displays only if Quartz pressure sensor)
2	<b>pf</b> = pressure temperature compensation frequency (displays only if Quartz pressure sensor)
3	<b>cf</b> = conductivity frequency (displays only if conductivity enabled with <b>Conductivity=Y</b> )

*26plus* runs continuously during test, drawing current. Press Esc key or click Stop to stop test.

**Diagnostic Commands** (*continued*)**VR**

Measure and display power:

Column	Output
1	Main battery voltage / 11.18
2	Back-up lithium voltage / 4.8187
3	Operating current (mA) / 20.04
4	Ground voltage

26plus runs continuously during test, drawing current. Press Esc key or click Stop to stop test.

**\*FlashInit**

Map bad blocks and erase FLASH memory (2048 blocks), **destroying all data**. 26plus requires you to enter **\*FlashInit** twice, to provide verification before it proceeds. All data bits are set to 1. Tide and wave sample number are set to 0. **Test takes approximately 1 hour, and cannot be interrupted once it has started.**

Send **\*FlashInit** (after uploading all data) if there are FLASH Read errors in Status (**DS**) response. If not encountering errors, use of command is optional, as 26plus writes over previously recorded information when **InitLogging** is used before beginning sampling. However, knowledge of initial memory contents (i.e., all 1's) can be a useful cross-check when data is retrieved.

**\*FlashGood**

Display number of good blocks in FLASH memory (should be 2008 to 2048 blocks, with each block 16K bytes). If number of good blocks not in this range, consult factory.

## Calibration Coefficients Commands

### Notes:

- Dates shown are when calibrations were performed. Calibration coefficients are initially factory-set and should agree with Calibration Certificates shipped with 26plus.
- See individual commands below to modify calibration coefficients.
- Calibration coefficients are applied to the raw data to output real-time and queried (**SL**, **SLO**, and some testing commands) data in engineering units.
- Pressure, temperature, and conductivity are stored in memory as raw data, before application of calibration coefficients.
- Data is uploaded from memory to a .hex file as raw data and/or partially processed data, depending on the parameter and whether the data is for waves or tides (see *Appendix III: Data Formats*). The .hex file also contains the **DC** command and response. Convert Hex uses the calibration coefficients in the **DC** response to convert the raw data to engineering units. Pressure slope, and **an additional pressure offset**, are entered in Convert Hex's Coefficient Configuration dialog box to make small post-deployment corrections for pressure sensor drift. Note that the pressure offset entered in Convert Hex is *in addition to the offset shown in the DC response*.

See *Section 6: Conversion into Tide and Wave Files – Extract Tide and Convert Hex*; also see *Sensor Calibration in Section 10: Routine Maintenance and Calibration*.

### DC

Display calibration coefficients. Examples are shown for 26plus with quartz pressure sensor and strain gauge pressure sensor.

*Example: 26plus with Paroscientific Digiquartz sensor (user input in bold).*

```
S>DC
Pressure coefficients: 15-apr-2004
U0 = 5.818158e+00
Y1 = -3.912547e+03
Y2 = -1.192010e+04
Y3 = 0.000000e+00
C1 = -6.273148e+03
C2 = 1.688132e+02
C3 = 1.655105e+04
D1 = 7.040300e-02
D2 = 0.000000e+00
T1 = 2.992117e+01
T2 = 6.588880e-01
T3 = 4.158092e+01
T4 = 1.073818e+02
M = 12582.9           (calculated by 26plus based on factory-input pressure sensor range)
B = 838.8            (calculated by 26plus based on factory-input pressure sensor range)
Offset = 0.000000e+00 (psia)
Temperature coefficients: 05-nov-2004
TA0 = -1.653843e-05
TA1 = 2.800270e-04
TA2 = -2.759926e-06
TA3 = 1.646110e-07
Conductivity coefficients: 05-nov-2004 (only if Conductivity=Y)
CG = -8.000000e+00
CH = 1.483257e+00
CI = -1.931111e-04
CJ = 9.170722e-05
CTCOR = 3.250000e-06
CPCOR = -9.570000e-08
CSLOPE = 1.000000e+00
```

*Example: 26plus with Strain Gauge sensor (user input in bold).*

```
S>DC
Pressure coefficients: 15-apr-2004
PA0 = -7.912454e-02
PA1 = 7.317688e-05
PA2 = -1.01280e-12
PTCA0 = 3.446204e+02
PTCA1 = -4.617518e+01
PTCA2 = -1.236197e-01
PTCB0 = 2.488438e+01
PTCB1 = 2.275000e-03
PTCB2 = 0.000000e+01
PTEMPA0 = -8.059255e+01
PTEMPA1 = 8.183057e+01
PTEMPA2 = -1.878352e+00
M = 279620.2         (calculated by 26plus based on factory-input pressure sensor range)
B = 18641.3          (calculated by 26plus based on factory-input pressure sensor range)
OFFSET = 0.00         (psia)
Temperature coefficients: 05-nov-2004
TA0 = -1.653843e-05
TA1 = 2.800270e-04
TA2 = -2.759926e-06
TA3 = 1.646110e-07
Conductivity coefficients: 05-nov-2004 (only if Conductivity=Y)
CG = -8.000000e+00
CH = 1.483257e+00
CI = -1.931111e-04
CJ = 9.170722e-05
CTCOR = 3.250000e-06
CPCOR = -9.570000e-08
CSLOPE = 1.000000e+00
```

The individual Coefficients Commands listed below are used to modify a particular coefficient or date:

**Note:**

F = floating point number  
S = string with no spaces

***Quartz Pressure***

<b>PCalDate=S</b>	S=calibration date.
<b>PU0=F</b>	F=U0.
<b>PY1=F</b>	F=Y1.
<b>PY2=F</b>	F=Y2.
<b>PY3=F</b>	F=Y3.
<b>PC1=F</b>	F=C1.
<b>PC2=F</b>	F=C2.
<b>PC3=F</b>	F=C3.
<b>PD1=F</b>	F=D1.
<b>PD2=F</b>	F=D2.
<b>PT1=F</b>	F=T1.
<b>PT2=F</b>	F=T2.
<b>PT3=F</b>	F=T3.
<b>PT4=F</b>	F=T4.
<b>POffset=F</b>	F=pressure offset (psia).

***Strain Gauge Pressure***

<b>PCalDate=S</b>	S=calibration date.
<b>PA0=F</b>	F=A0.
<b>PA1=F</b>	F=A1.
<b>PA2=F</b>	F=A2.
<b>PTCA0=F</b>	F=PTCA0.
<b>PTCA1=F</b>	F=PTCA1.
<b>PTCA2=F</b>	F=PTCA2.
<b>PTCB0=F</b>	F=PTCB0.
<b>PTCB1=F</b>	F=PTCB1.
<b>PTCB2=F</b>	F=PTCB2.
<b>PTempA0=F</b>	F=PTempA0.
<b>PTempA1=F</b>	F=PTempA1.
<b>PTempA2=F</b>	F=PTempA2.
<b>POffset=F</b>	F=pressure offset (psia).

***Temperature***

<b>TCalDate=S</b>	S=calibration date.
<b>TA0=F</b>	F=A0.
<b>TA1=F</b>	F=A1.
<b>TA2=F</b>	F=A2.
<b>TA3=F</b>	F=A3.

***Conductivity***

<b>CCalDate=S</b>	S=calibration date.
<b>CG=F</b>	F=G.
<b>CH=F</b>	F=H.
<b>CI=F</b>	F=I.
<b>CJ=F</b>	F=J.
<b>CTCor=F</b>	F=TCor.
<b>CPCor=F</b>	F=PCor.
<b>CSlope=F</b>	F=Slope correction.

## Using SBE 26plus as a Tide Recorder

**Note:**

It is not possible to completely eliminate wave measurements in the 26plus.

If you are not interested in wave data, the SBE 26plus can be set up to minimize the number of wave measurements. Respond to the prompts in the **SetSampling** command as follows:

- *measure wave burst after every N tide samples:*  
Set to 10,000, which is the largest allowable number.
- *number of wave samples per burst (multiple of 4) = :*  
Set to 4, which is the smallest allowable number.
- *TXWAVESTATS (real-time wave statistics) (y/n) = :*  
Set to N, which disables calculation of real-time wave statistics.
- *Remaining parameters:*  
Set as desired.

With this sampling scheme, the 26plus will do a wave burst consisting of 4 measurements after every 10,000 tide samples. The wave measurement will have minimal effect on power and memory consumption, allowing you to maximize the number of tide samples.

---

## Using SBE 26plus as a Wave Recorder

**Note:**

It is not possible to completely eliminate tide measurements in the 26plus.

If you are not interested in tide data, the SBE 26plus can be set up to minimize the number of tide measurements. Respond to the prompts in the **SetSampling** command as follows:

- *tide interval (integer minutes) = :*  
Set to the interval at which you want to take wave bursts.
- *tide measurement duration = :*  
Set to 10 sec, which is the smallest allowable number.
- *Measure wave burst after every N tide samples:*  
Set to 1.
- *Remaining parameters:*  
Set as desired.

With this sampling scheme, the 26plus will do a tide measurement lasting for 10 seconds each time it does a wave burst. The tide measurement will have minimal effect on power and memory consumption, allowing you to maximize the number of wave bursts.



## Setting Time in SBE 26plus to Synchronize Sampling of Multiple Instruments

**Note:**

Software to provide accurate time on your computer is not supplied by Sea-Bird.

If you are running software on your computer that provides the computer with an accurate real-time stamp, the DateTime menu in SeatermW allows you to set the date and time in the SBE 26plus to an accuracy of  $\pm 25$  msec of the time provided by the timekeeping software. This may be useful if you plan to deploy several instruments, and want to coordinate sampling so that each 26plus measures tides and waves on exactly the same schedule. Coordinating sampling can be accomplished by:

- Setting the time in each instrument accurately, using the DateTime menu,
- Setting up each instrument to sample at the same intervals and durations, and
- Setting up each instrument to start sampling at a delayed date and time – using the same start date and time for each instrument.

Set accurate time and coordinate sampling as follows:

1. In SeatermW, click DateTime. The following dialog box appears:

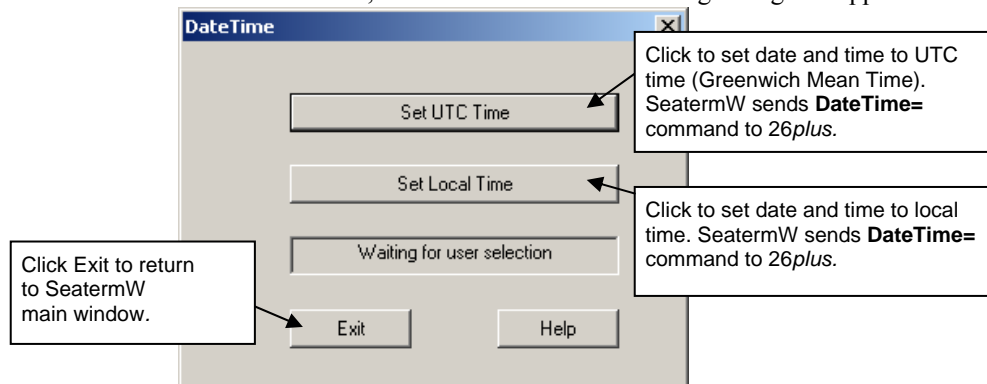

Click the desired time setting (UTC or local time). SeatermW sends the **DateTime=** command to the 26plus, using the computer date and time. Click Exit.

2. If desired, set up the 26plus to start logging at some time in the future, allowing you to coordinate sampling to begin in multiple instruments at the same time:
  - Send the **SetStartTime** command to the 26plus. The 26plus prompts you to enter the desired start date and time.
  - Send the **SetSampling** command. Set up the desired sampling scheme, and enter Y in response to the *Use start time?* prompt.

## Installing and Deploying SBE 26plus

### CAUTION:

Do not use WD-40 or other petroleum-based lubricants, as they will damage the connectors.

1. Install a cable (if transmitting real-time tide and/or wave data) or dummy plug for the data I/O connector (4-pin for standard RS-232, 6-pin for optional RS-422 / RS-485) on the 26plus end cap:
  - A. Lightly lubricate the inside of the cable connector/plug with silicone grease (DC-4 or equivalent).
  - B. **Standard Connector** - Install the connector/plug, aligning the raised bump on the side of the plug with the large pin (pin 1 – ground) on the 26plus. Remove any trapped air by *burping* or gently squeezing the plug near the top and moving your fingers toward the end cap.  
**OR**  
**MCBH Connector** – Install the connector/plug, aligning the pins.
  - C. Place the locking sleeve over the connector/plug. Tighten the locking sleeve finger tight only. **Do not overtighten the locking sleeve and do not use a wrench or pliers.**
2. If not using the SBE 4M conductivity sensor, install a dummy plug and locking sleeve on the 26plus 3-pin bulkhead connector. Use the technique described in Step 1 for lubricating and burping a standard connector.

### Note:

Enable acquisition of conductivity data by sending **Conductivity=Y** in SeatermW when programming the 26plus for deployment.

3. (Optional) Install the SBE 4M conductivity sensor:
  - A. Mount the SBE 4M to the 26plus with the supplied mounting bracket, positioning the SBE 4M connector towards the conductivity connector on the 26plus.
  - B. Connect the SBE 4M to the 26plus with the supplied cable, using the technique described in Step 1 for lubricating and burping a standard connector, and then installing the locking sleeve.
  - C. Remove the Tygon tubing that was looped end-to-end around the SBE 4M conductivity cell to keep the cell clean while stored.
  - D. See *Application Note 70: Installing Anti-Foulant Device Mount Kit on SBE 4, 16, 19, and 21 Conductivity Cells* and *Appendix V: AF24173 Anti-Foulant Device*.
4. (Optional) Mount the 26plus in the Sea-Bird mounting fixture:
  - A. Slide the mooring pin through the 26plus lift eye hole in the direction shown.
  - B. Install the retaining ring in the lift eye hole recess, to hold the mooring pin to the 26plus. Push part of the retaining ring into the recess, and hold it in place with a small tool (such as tweezers or small screwdriver). Using another pair of tweezers, work your way around the retaining ring, pushing it into the recess.
  - C. Rotate the 26plus into the mounting fixture as shown.
  - D. Screw the mooring pin into the mounting fixture.

Mooring pin

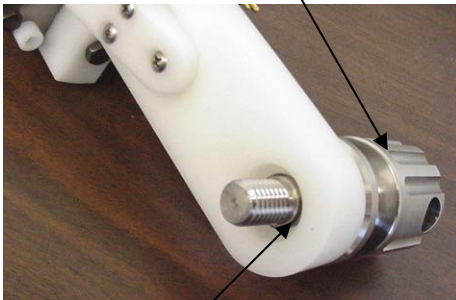

Install retaining ring in recess after inserting mooring pin

Rotate 26plus into mounting fixture

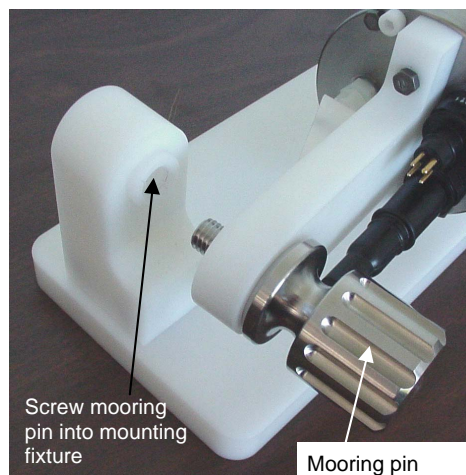
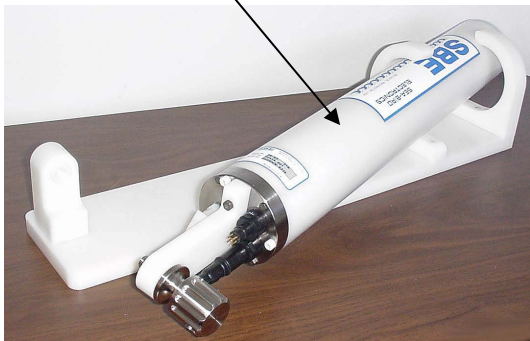

Screw mooring pin into mounting fixture

Mooring pin

## Recovering SBE 26plus

**WARNING!**

**If the 26plus stops working while underwater, or shows other signs of flooding or damage, carefully secure it away from people until you have determined that abnormal internal pressure does not exist or has been relieved.** Pressure housings

may flood under pressure due to dirty or damaged o-rings, or other failed seals. When a sealed pressure housing floods at great depths and is subsequently raised to the surface, water may be trapped at the pressure at which it entered the housing, presenting a danger if the housing is opened before relieving the internal pressure. Instances of such flooding are rare. However, a housing that floods at 600 meters depth holds an internal pressure of more than 800 psia, and has the potential to eject the end cap with lethal force.

A housing that floods at 50 meters holds an internal pressure of more than 85 psia; this force could still cause injury.

If you suspect the 26plus is flooded, point the 26plus in a safe direction away from people, and loosen the 3 screws on the connector end cap about ½ turn. If there is internal pressure, the end cap will *follow* the screws out, and the screws will not become easier to turn. In this event, loosen 1 bulkhead connector very slowly, at least 1 turn. This opens an o-ring seal under the connector. Look for signs of internal pressure (hissing or water leak). If internal pressure is detected, let it bleed off slowly past the connector o-ring. Then, you can safely remove the end cap.

Rinse the 26plus with fresh water. See *Section 10: Routine Maintenance and Calibration* for (optional) conductivity cell cleaning and storage.

## Uploading Data from Memory

The SBE 26plus can upload data in ASCII at baud rates up to 38,400, or in binary at baud rates up to 115,200. Binary upload at 115,200 is approximately **six times faster** than ASCII upload at 38,400, because each byte is one character in binary but two characters in ASCII. Binary upload of the full memory (32 MB) at 115,200 baud requires approximately 3.5 hours. If binary upload is selected, SeatermW uploads the data in binary and then converts the data to ASCII, resulting in a .hex data file that is identical to one uploaded in ASCII.

1. In SEASOFT for Waves' Run menu, select SeatermW. SeatermW appears.
2. Click Configure. The Configuration dialog box appears. Verify/modify the instrument, Comm port, and baud rate, and whether to upload in binary (if *binary upload* is selected) or in ASCII. Click OK.

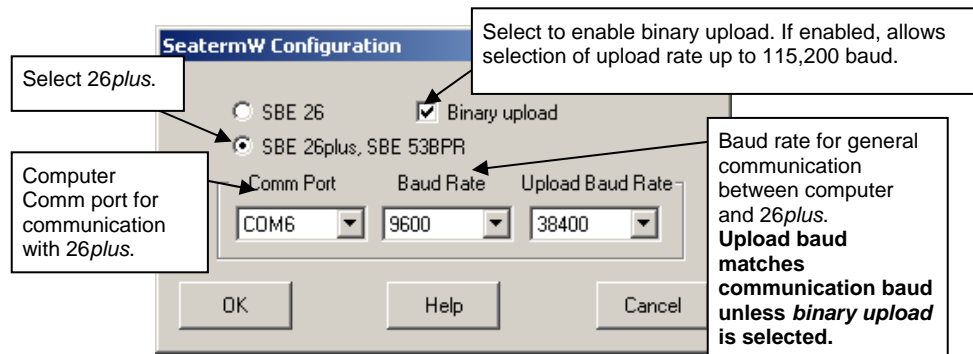

3. Click Connect. The S> displays. This shows that correct communications between the computer and 26plus has been established. If the system does not respond with the S> prompt:
  - Click Connect again.
  - Verify the correct instrument, Comm port, and baud rate were selected.
  - Check cabling between the computer and 26plus.
4. If the 26plus is still logging, command it to stop logging by typing **Stop** and pressing the Enter key. You may need to press the Esc key before entering **Stop** to get the 26plus to stop if it is in the middle of sampling.
5. Display 26plus status information by clicking Status. The status response should indicate `logging = no`.

**Note:**

The 26plus communicates at 9600 baud (factory-set default), 8 data bits, 1 stop bit, and no parity, as documented on the instrument Configuration Sheet. Baud rate can be changed with **Baud=**; other parameters cannot be modified.

6. Click Upload to upload stored data in a form that SEASOFT for Waves' data processing modules can use. SeatermW responds as follows:
  - A. SeatermW sends the status (**DS**) command, displays the response, and writes the command and response to the upload file, with each line preceded by \*. **DS** provides information regarding the number of samples in memory, tide interval, etc.
  - B. SeatermW sends the calibration coefficients (**DC**) command, displays the response, and writes the command and response to the upload file, with each line preceded by \*. **DC** provides information regarding the sensor calibration coefficients.
  - C. In the Save As dialog box, enter the desired upload file name and click OK. The upload file has a .hex extension.
  - D. **ASCII Upload** (if binary upload was not selected in Step 2) – SeatermW sends the data upload command (**DD**). SeatermW writes the data to the upload file. The Status bar at the bottom of the SeatermW window displays the progress of the upload, indicating the number of uploaded lines of data.
  - E. **Binary Upload** (if binary upload was selected in Step 2) – SeatermW tests that the selected binary upload baud rate is supported by your computer. If it is not, the upload is aborted. SeatermW sends **ByteCount** to determine how many bytes of data are in memory, because only 500,000 bytes can be uploaded in one block. SeatermW sends the data upload command (**DBbaud,b,e**), as many times as needed to upload all the data in memory in blocks of 500,000 bytes. SeatermW converts the binary data back to ASCII, and writes the data to the upload file. The Status bar at the bottom of the SeatermW window displays the progress of the upload, indicating the number of uploaded lines of data.
7. Type **QS** and press the Enter key to put the 26plus in quiescent (sleep) state until ready to redeploy.
8. Ensure all data has been uploaded by processing the data. See *Section 6: Conversion into Tide and Wave Files – Extract Tide and Convert Hex*.

**Note:**

Although SeatermW sends **DBbaud,b,e** to upload data in binary, the uploaded .hex file shows the **DD** command, so the file looks exactly the same, regardless of whether ASCII or binary upload was used.

# Section 6: Conversion into Tide and Wave Files – Extract Tide and Convert Hex

This section covers:

- Splitting uploaded data from multiple logging sessions into separate data files using ExtractTide.exe.
- Converting uploaded hex (.hex) data into separate wave data (.wb) and tide data (.tid) files, with data in engineering units, using Convert Hex in SEASOFT for Waves. The data must be converted and split into separate wave and tide files before further processing by SEASOFT for Waves.

## Extract Tide

### Note:

Extract Tide is not accessed through SEASOFT for Waves. It is a separate program that is automatically installed when SEASOFT for Waves is installed, in the same directory as SEASOFT for Waves.

The SBE 26plus memory can hold data from multiple logging sessions. Each time logging is started, a beginning tide record is stored, to designate the start of the logging session. **If the uploaded file includes data from multiple logging sessions, run Extract Tide to separate each session into a separate file before converting the data with Convert Hex.** If you try to run Convert Hex on a file containing data from multiple sessions, Convert Hex provides an error message directing you to run Extract Tide.

If you are not certain if the 26plus memory holds data from multiple sessions, send **DS** and review the response. If the total number of tide measurements in memory does not equal the number of tide measurements since the last start, the memory holds data from multiple sessions.

**Example:** 26plus memory holds data from multiple logging sessions. Status response shows 5 tide measurements since last logging start, but 10 total tide measurements in memory.

```
S>DS
SBE 26plus V 6.1a SN 12345 26 Jan 2006 13:21:13
. . . . .
total recorded tide measurements = 10
total recorded wave bursts = 2
tide measurements since last start = 5
wave bursts since last start = 1
. . . . .
```

Since these are not equal, memory holds data from multiple logging sessions.

1. Double click on ExtractTide.exe. The dialog box looks like this:

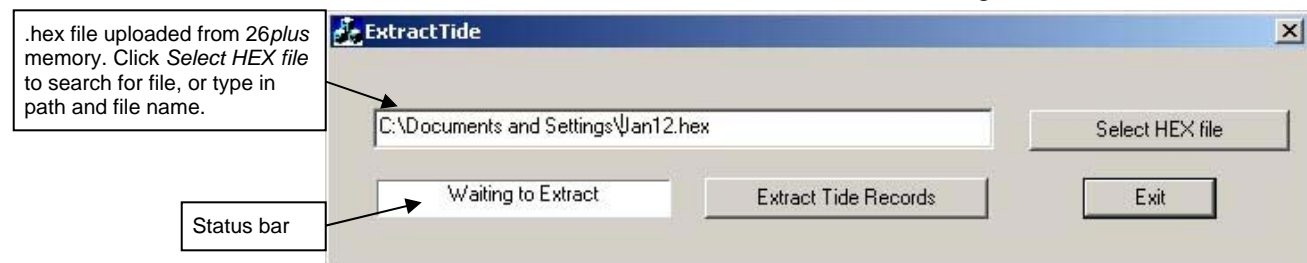

2. Click *Extract Tide Records* to process the data; when completed, the Status bar shows *Finished, x files created*, where x is the number of logging sessions in the uploaded data. Extract Tide creates a separate file for each time logging was started, with -1, -2, etc. appended to the file name. For example, if there are 3 logging sessions recorded in Jan12.hex, the output file names will be Jan12-1.hex, Jan12-2.hex, and Jan12-3.hex. Run Convert Hex on each file created by Extract Tide.

## Convert Hex

### Notes:

- If the uploaded file includes data from multiple logging sessions, run Extract Tide before Convert Hex.
- The first time you run Convert Hex, the Coefficients dialog box (Step 2 below) appears first.

.hex file uploaded from 26plus memory or output from Extract Tide. Click Browse to search for file, or type in path and file name.

Desired path and file names for output tide (.tid) and wave (.wb) file. Default paths and file names are same as input .hex file. If desired, type in path and file name to change it from default.

Conversion status bar.

### Note:

SeasoftWaves.ini contains the location and file name of the last saved .psa file for each module. SeasoftWaves.ini is stored in %USERPROFILE%\Local Settings\Apps\Sea-Bird (Example C:\Documents and Settings\dbresko\Local Settings\Apps\Sea-Bird)

Convert Hex converts uploaded hex (.hex) data into separate wave (.wb) and tide (.tid) files, with data in ASCII engineering units. Convert Hex must be run before further processing by SEASOFT for Waves.

1. In SEASOFT for Waves' Run menu, select Convert Hex. The dialog box looks like this:

Input file: C:\26plusTestData.hex

Output tide file: C:\26plusTestData.tid

Output wave file: C:\26plusTestData.wb

Coefficients (required): C:\26plusTest.psa

Start Year: 2000 (Start Year not used for SBE 26plus or SBE 53 BPR)

Not used for 26plus.

Conversion status bar.

Convert File Help Exit

.psa file contains calibration coefficients to make small corrections for pressure sensor drift between calibrations. Click Coefficients to view or modify coefficients or search for different file.

Enter information in the dialog box. Click Coefficients to enter / verify calibration coefficients for converting hex data to engineering units.

2. The Coefficients dialog box looks like this:

Coefficients file: C:\26plusTest.psa

Instrument:  SBE 26  SBE 26plus  SBE 53

Pressure Sensor

Slope Correction = 1.000000

Offset Correction = 0.000000

For SBE 26plus and SBE 53, use default values if not correcting for drift during deployment.

Set to Default Values

Save & Exit Open Save As Help Cancel

Slope and offset (psia) used to make small corrections for pressure sensor drift between calibrations. Other P coefficients are programmed into 26plus at Sea-Bird; they can be viewed with DC, and modified with calibration coefficient commands, in SeatermW. Note that offset entered here is *in addition* to offset shown in DC response.

Save & Exit to save updated .psa file and return to Convert Hex to Wave and Tide dialog box.  
Open to select a different .psa file.  
Save As to save updated .psa file settings to a different .psa file.

Make desired changes. Click OK to return to Convert Hex to Wave and Tide dialog box.

3. Click *Convert File* to process the data. The Status bar at the bottom of the dialog box shows the progress of the calculations; when completed, the Status bar shows *Finished conversion*.

- If you have a .hex file with multiple logging sessions, and did not run Extract Tide, Convert Hex provides the following error message:

```
Can not process a file with multiple tide
records, run EXTRACTTIDE.EXE to separate the
records.
```

Run Extract Tide, and then run Convert Hex for each of the files created by Extract Tide.



# Section 7: Tide Data Processing – Merge Barometric Pressure

## Note:

The barometric pressure (.bp) file is **not** supplied by Sea-Bird. It is created by the user, based on local barometric pressure data (such as that from a local weather station). See *Input Barometric Pressure File Format* below for the required data format.

Merge Barometric Pressure reads in a tide (.tid) file (created with Convert Hex) and a barometric pressure (.bp) file, and subtracts barometric pressure from the tide data. The time in the files does not need to be aligned – Merge Barometric Pressure uses linear interpolation to align the data in time before subtracting barometric pressure. Merge Barometric Pressure can also convert tide pressure to water depth in meters, using average density and gravity.

Both the input tide data and output adjusted file have a .tid extension. However, Merge Barometric Pressure will not process a .tid file that it has already processed, preventing a user from erroneously removing barometric pressure multiple times from the tide data.

Remove barometric pressure as follows:

1. In SEASOFT for Waves' Run menu, select Merge Barometric Pressure. The File Setup tab looks like this:

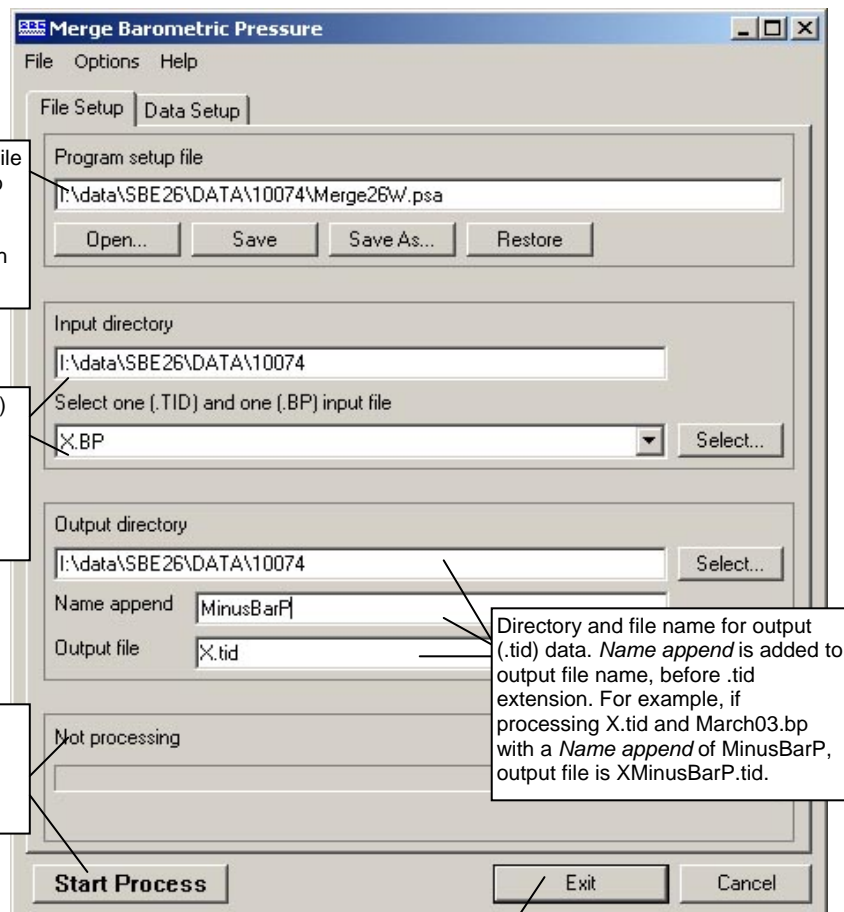

## Note:

SeasoftwareWaves.ini contains the location and file name of the last saved .psa file for each module. SeasoftwareWaves.ini is stored in %USERPROFILE%\Local Settings\Apps\Sea-Bird (Example C:\Documents and Settings\dbresko\Local Settings\Apps\Sea-Bird)

File to store all information input in File Setup and Data Setup tabs. **Open** to select a different .psa file, **Save** or **Save As** to save current settings, or **Restore** to reset all settings to match last saved version.

Directory and file names for tide (.tid) data and barometric pressure (.bp) data. Note that both .tid and .bp files must be in same directory, but they can have different names. **Select** to pick different files.

Click **Start Process** to begin processing data. Status field shows *Processing complete* when done.

Directory and file name for output (.tid) data. *Name append* is added to output file name, before .tid extension. For example, if processing X.tid and March03.bp with a *Name append* of MinusBarP, output file is XMinusBarP.tid.

Return to SEASOFT for Waves window.

- If *Confirm Program Setup Change* was selected in Options menu - If you made changes and did not Save or Save As, program asks if you want to save changes.
- If *Confirm Program Setup Change* was not selected in Options menu - This says **Save & Exit**. If you do not want to save changes, click Cancel to exit.

Make the desired selections.

2. Click on the Data Setup tab. The Data Setup tab looks like this:

If selected, output .tid file contains water depth in place of pressure.

Units in input barometric pressure (.bp) file – psia or millibars.

Average density and gravity value to use to calculate water depth. Entries ignored if you do not select *Convert Pressure to Water Depth*.

Click **Start Process** to begin processing data. Status field on File Setup tab shows *Processing complete* when done.

Return to SEASOFT for Waves window.

- If *Confirm Program Setup Change* was selected in Options menu - If you made changes and did not Save or Save As, program asks if you want to save changes.
- If *Confirm Program Setup Change* was not selected in Options menu - This says **Save & Exit**. If you do not want to save changes, click Cancel to exit.

**Note:**

Merge Barometric Pressure adds descriptive headings to the pressure (or depth), temperature, and optional conductivity and salinity columns. The presence of headings in the .tid file indicates that it has been processed by Merge Barometric Pressure. See *Appendix III: Data Formats*.

Make the desired selections and click *Start Process* to process the data.

## Input Barometric Pressure File Format

**Note:**

The barometric pressure (.bp) file is **not** supplied by Sea-Bird. It is created by the user, based on local barometric pressure data (such as that from a local weather station).

The required format for the input barometric pressure (.bp) file is:

```
MM/DD/YY HH:MM:SS P
MM/DD/YY HH:MM:SS P
```

where

MM = month                      DD = day                      YY = year  
HH = hour                        MM = minute                SS = second

P = barometric pressure in psia or millibars

(1 standard atmosphere = 14.7 psia or 1013.5 millibars)

**Example .bp File:**

```
07/01/94 00:00:00 1015.5
07/01/94 01:00:00 1016.4
07/01/94 02:00:00 1017.3
```

---

## Merge Barometric Pressure Algorithm

The linear interpolation algorithm is:

$$p_{bp} = p_0 + [(t - t_0) * (p_1 - p_0) / (t_1 - t_0)]$$

$$\text{corrected pressure} = p - p_{bp}$$

where

t = time of tide sample in .tid file  
p = pressure in .tid file at time t  
t0 = latest time in .bp file that is less than or equal to t  
p0 = barometric pressure at time t0  
t1 = earliest time in .bp file that is greater than or equal to t  
p1 = barometric pressure at time t1  
p<sub>bp</sub> = interpolated barometric pressure

Depth is calculated as:

$$\text{depth} = \text{corrected pressure} / (\text{average density} * \text{gravity})$$

See Appendix VII: Pressure-to-Depth Conversion.

# Section 8: Wave Data Processing – Process Wave Burst Data and Create Reports

**Notes:**

- See *Appendix VI: Wave Theory and Statistics* for details on the calculations made by SEASOFT for Waves.
- The *26plus* can also be programmed to output real-time wave statistics. See *Command Descriptions* in *Section 5: SBE 26plus Setup, Installation, and Data Upload – SeatermW*.

SEASOFT for Waves includes two wave data processing modules, which are covered in this section:

- **Process Wave Burst Data** – Compute wave statistics from an input .wb wave burst file. Output .was statistics and results from auto-spectrum analysis, .rpt summary report, .wts statistics from surface wave zero crossing analysis, .wt surface wave time series, and .wss Fast Fourier Transform coefficients.
- **Create Reports** - Create .r26 file with one line of surface wave time series and/or wave burst auto-spectrum statistics for each processed wave burst, from input .was and .wts files.

---

## Process Wave Burst Data

Process Wave Burst Data computes wave statistics from an input .wb wave burst file (created in Convert Hex). Process Wave Burst Data outputs three (or optionally four or five) files:

- Statistics and results from auto-spectrum analysis to a .was file.
- Summary report from auto-spectrum analysis to a .rpt file.
- Statistics from surface wave zero crossing analysis to a .wts file.
- (optional) Surface wave time series to a .wt file
- (optional) Fast Fourier Transform coefficients to a .wss file

Process wave data as follows:

**Note:**

SeasoftWaves.ini contains the location and file name of the last saved .psa file for each module. SeasoftWaves.ini is stored in %USERPROFILE%\Local Settings\Apps\Sea-Bird (Example C:\Documents and Settings\dbresko\Local Settings\Apps\Sea-Bird)

1. In SEASOFT for Waves' Run menu, select Process Wave Burst Data. The File Setup tab looks like this:

File to store all information input in File Setup and Data Setup tabs. **Open** to select a different .psa file, **Save** or **Save As** to save current settings, or **Restore** to reset all settings to match last saved version.

Directory and file name for wave (.wb) data. **Select** to pick different file.

Click **Start Process** to begin processing data. Status field shows *Processing complete* when done.

Directory and file name for output data. *Name append* is added to output file name, before extension. For example, if processing X.wb with a *Name append* of Wave, output files are testWave.was, testWave.rpt, testWave.wts, etc.

Return to SEASOFT for Waves window.

- If *Confirm Program Setup Change* was selected in Options menu - If you made changes and did not Save or Save As, program asks if you want to save changes.
- If *Confirm Program Setup Change* was not selected in Options menu - This says **Save & Exit**. If you do not want to save changes, click Cancel to exit.

Make the desired selections.

2. Click on the Data Setup tab. The Data Setup tab looks like this:

Average temperature and salinity used to calculate density, required for wave statistics algorithm.

High frequency cutoff for processing wave data,  $f_{max}$ , is smaller of:

- frequency where (measured pressure / pressure at surface) < (minimum allowable attenuation / wave sample duration).
- 1 / minimum period

If getting high frequency noise in output, adjust minimum allowable attenuation and/or minimum period. Frequencies >  $f_{max}$  are not processed unless *Use filter cutoff* is selected.

Low frequency cutoff  $f_{min}$  = (1 / maximum period). Frequencies <  $f_{min}$  are not processed unless *Use filter cutoff* is selected.

If **not** selected, all Fourier coefficients for frequencies >  $f_{max}$  and <  $f_{min}$  are set to 0. If selected, filter ramps Fourier coefficients down to 0 for frequencies >  $f_{max}$  and <  $f_{min}$ .

Select number of wave bursts to process and number of wave bursts to skip at start of data file. Default - process all bursts.

Begin processing. Status field on File Setup tab shows *Processing complete* when done.

You may have used Plan Deployment to determine desired value; see *Section 4: Pre-Deployment Planning – Plan Deployment and Battery and Memory Endurance*.

Hanning window suppresses spectral leakage that occurs when time series contains periodic signal that does not correspond to one of exact frequencies of Fast Fourier Transform.

Outputting .wt and/or .wss files is optional; other file types (.was, .rpt, and .wts) are always output.

Return to SEASOFT for Waves window.

- If *Confirm Program Setup Change* was selected in Options menu - If you made changes and did not Save or Save As, program asks if you want to save changes.
- If *Confirm Program Setup Change* was not selected in Options menu - This says **Save & Exit**. If you do not want to save changes, click Cancel to exit.

Make the desired selections and click *Start Process* to process the data.

3. The Verify Setup dialog box appears:

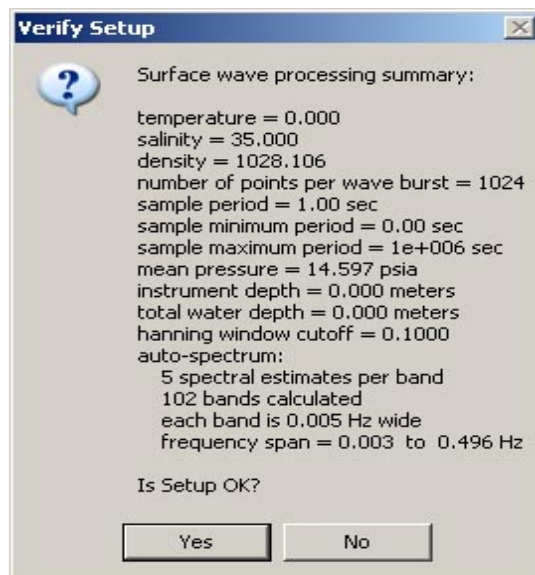

The dialog box summarizes data from the input .wb file and user inputs from the Data Setup tab, and shows calculated values for density, number of bands, band width, and frequency span. Review the summary; click *Yes* to process data.

## Process Wave Burst Data Algorithm

For each wave burst, Process Wave Burst Data performs an auto spectrum analysis:

- Reads burst into an array.
- Removes mean, saves mean value.
- Uses mean value, and average water temperature and average salinity (input by user) to compute density.
- Removes trend.
- Makes array a power of two.
- Applies Hanning window to suppress side-lobe leakage.
- Adjusts scale factor to account for tapering by Hanning window.
- Fast Fourier Transforms to create raw spectral estimates of subsurface pressure.
- Computes maximum frequency to process.
- Sets Fourier coefficients greater than maximum frequency or less than minimum frequency to 0; **or** (if Use filter cutoff is selected) applies a filter that ramps the Fourier coefficients down to 0 for frequencies greater than maximum frequency or less than minimum frequency
- Saves Fourier coefficients.
- Band averages raw spectral estimates to create auto-spectrum.
- Applies dispersion transfer function to band center frequencies.
- Calculates wave statistics from auto-spectrum: variance, energy, significant wave height, and significant period.

Using the saved (non-band-averaged) Fourier coefficients, Process Wave Burst Data performs a surface wave zero crossing analysis:

- Applies dispersion transfer function to each frequency.
- Inverse Fast Fourier Transforms to create surface wave time series.
- Applies inverse Hanning window and adjusts scale factor.
- Zeroes all elements where inverse Hanning factor is greater than 10.
- Performs zero crossing analysis of surface wave time series to create an array of individual waves and their corresponding periods.
- Sorts wave array in ascending order.
- Calculates wave statistics from surface wave time series: average wave height, average period, maximum wave height, significant period, significant wave height  $H_{1/3}$ ,  $H_{1/10}$ ,  $H_{1/100}$ .

## Create Reports: Summarize Wave Data

Create Reports creates a file containing one line of surface wave time series and/or wave burst auto-spectrum statistics for each processed wave burst. The input .wts file contains surface wave time series statistics and the input .was file contains wave burst auto spectrum statistics (these files are created in Process Wave Burst Data). The output .r26 file format is user-defined and can contain one or more of the following variables:

	<b>Variable</b>	<b>Column Label</b>
<i>From Surface Wave Time Series Statistics (.wts) File</i>	time	time
	burst number	burst
	pressure sensor depth	depth
	number of waves	nwaves
	variance	var-wts
	Energy	energy-wts
	average wave height	avgheight
	average wave period	avgper
	maximum wave height	maxheight
	significant wave height	swh-wts
	significant wave period	swp-wts
	$H_{1/10}$	H1/10
	$H_{1/100}$	H1/100
	<i>From Wave Burst Auto-Spectrum Statistics (.was) File</i>	variance
energy		energy-was
significant wave height		swh-was
significant wave period		swp-was



**Note:**

SeasoftWaves.ini contains the location and file name of the last saved .psa file for each module. SeasoftWaves.ini is stored in %USERPROFILE%\Local Settings\Apps\Sea-Bird (Example C:\Documents and Settings\dbresko\Local Settings\Apps\Sea-Bird)

Proceed as follows:

1. In SEASOFT for Waves' Run menu, select Create Reports. The File Setup tab looks like this:

File to store all information input in File Setup and Data Setup tabs. **Open** to select a different .psa file, **Save** or **Save As** to save current settings, or **Restore** to reset all settings to match last saved version.

Directory and file name for wave (.was and .wts) data. **Select** to pick different file. Note that **both** .was and .wts files must be selected, even if you intend to output variables from only one of the files. Files must be in same directory, and must have same name (before extension).

Click **Start Process** to begin processing data. Status field shows *Processing complete* when done.

Directory and file name for output data. *Name append* is added to output file name, before extension. For example, if processing X.was and X.wts with a *Name append* of Wave, output file is XWave.r26.

Return to SEASOFT for Waves window.

- If *Confirm Program Setup Change* was selected in Options menu - If you made changes and did not Save or Save As, program asks if you want to save changes.
- If *Confirm Program Setup Change* was not selected in Options menu - This says **Save & Exit**. If you do not want to save changes, click Cancel to exit.

Make the desired selections.

2. Click on the Data Setup tab. The Data Setup tab looks like this:

If selected, output .r26 file contains labels above data columns (labels match variable names in Select Variables dialog box).

If selected, output .r26 file contains a descriptive text header that includes input file name and path, wave integration time, number of points in burst, height of 26plus above bottom, and water density.

Separate each variable in output .r26 file with a space, tab, semi-colon, or colon.

Click to bring up a list of variables. See Step 3 below.

Output date and time as Julian days, hh:m,m:ss (hours, minutes, seconds), or dd mmm yyyy hh:mm:ss (day, month, year, hours, minutes, seconds).

Click **Start Process** to begin processing data. Status field shows *Processing complete* when done.

Return to SEASOFT for Waves window.

- If *Confirm Program Setup Change* was selected in Options menu - If you made changes and did not Save or Save As, program asks if you want to save changes.
- If *Confirm Program Setup Change* was not selected in Options menu - This says **Save & Exit**. If you do not want to save changes, click Cancel to exit.

Make the desired selections.

3. Click *Select Variables*. The Select Variables dialog box looks like this:

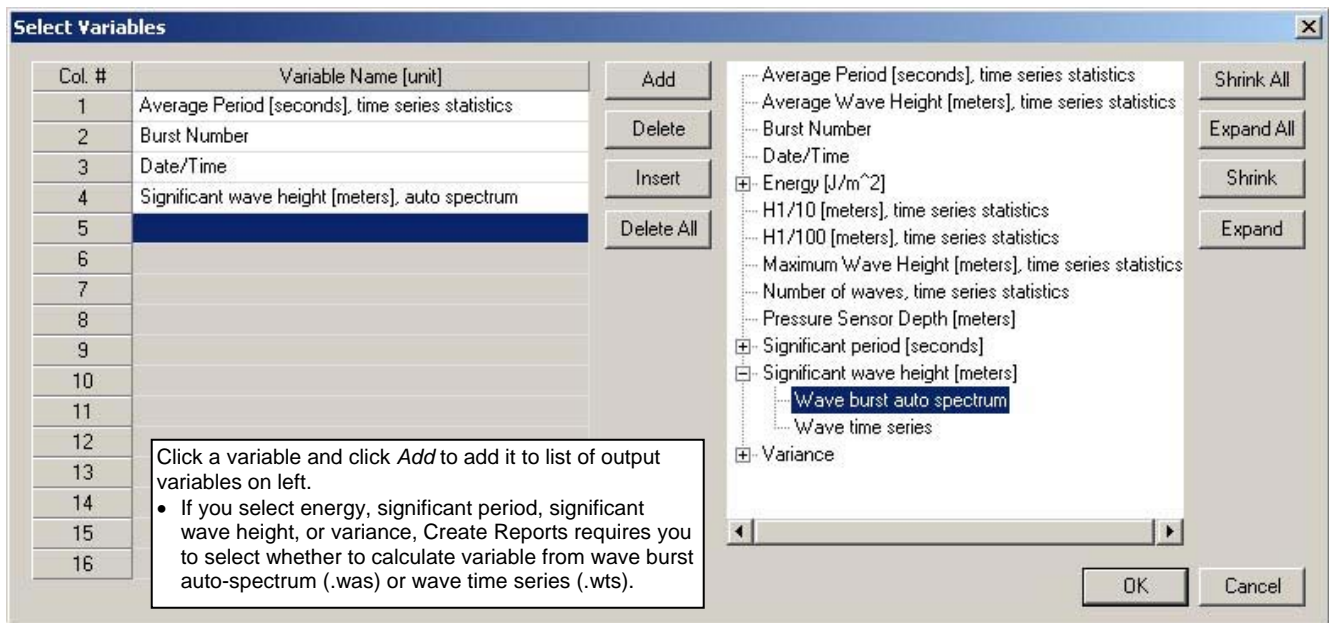

Make the desired selections and click *OK* to return to the Create Reports data setup tab.

4. Click *Start Process* to process the data.

# Section 9: Data Plotting – Plot Data

Plot Data displays and plots data from files with a .tid, .wb, .was, .wts, or .wt file extension. Plot Data:

- Plots up to five variables on one plot, with one X axis and up to four Y axes.
- Zooms in on plot features.
- Sends plots to a printer, saves plots to the clipboard for insertion in another program (such as Microsoft Word), or saves plots as graphic files in bitmap, metafile, or JPEG format.

## Note:

SeasoftWaves.ini contains the location and file name of the last saved .psa file for each module. SeasoftWaves.ini is stored in %USERPROFILE%\Local Settings\Apps\Sea-Bird (Example C:\Documents and Settings\dbresko\Local Settings\Apps\Sea-Bird)

In SEASOFT for Waves' Run menu, select Plot Data. Each tab of the dialog box is described below, as well as options for viewing, printing, and saving plots.

## File Setup Tab

The File Setup tab defines the Program Setup file, input data file(s), and output plot file name. The File Setup tab looks like this:

File to store all information input in File, Plot, and Axis tabs. **Open** to select a different .psa file, **Save** or **Save As** to save current settings, or **Restore** to reset all settings to match last saved version.

Directory and file names for input data files (.tid, .wb, .was, .wts, and / or .wt files). All files must be in same directory and have same name before extension. **Select** to pick different files.

Click **Start Process** to begin processing data. Status field shows *Processing complete* when done.

Default directory and file name (can be changed while viewing plot) for outputting graphic file in .wmf, .jpg, or .bmp format. Default file name is set to match input file name, with additional characters added before extension, in order listed below:

- *Name append*, to allow user to add descriptive information to file name.
- Plot type (as for Auto Spectrum, *tts* for Tide Time Series, *ws* for Wave Statistics, or *wts* for Wave Time Series).
- Wave burst number for types that have a plot for each wave burst

For example, if processing X.tid, X.wb, X.was, X.wts, and X.wt with a Name Append of Color and outputting .jpg files, output file names are XColorAs-0.jpg, XColorAs-1.jpg, etc. (Auto Spectrum: 1 file for each selected wave burst); XColorTts.jpg (Tide Time Series); XColorWs.jpg (Wave Statistics); XColorWts-0.jpg, XColorWts-1.jpg, etc. (Wave Time Series: 1 file for each selected wave burst).

Return to SEASOFT for Waves window.

- If *Confirm Program Setup Change* was selected in Options menu - If you made changes and did not Save or Save As, program asks if you want to save changes.
- If *Confirm Program Setup Change* was not selected in Options menu - This says **Save & Exit**. If you do not want to save changes, click Cancel to exit.

## Plot Setup Tab

The Plot Setup tab defines the plot type, data to be included, and plot layout (title, color, font, grid lines, etc.). The Plot Setup tab looks like this:

The screenshot shows the 'Plot Data' dialog box with the 'Plot Setup' tab selected. The dialog has a menu bar (File, Options, Help) and several tabs (File Setup, Plot Setup, X Axis, Y Axis 1, Y Axis 2). The 'Plot Setup' tab contains the following settings and callouts:

- Plot type:** Wave Time Series. Callout: Available selections dependent on input file types selected on File Setup tab: Wave Time Series, Tide Time Series, Auto Spectrum, Wave Statistics.
- Plot title:** Wave Time Series Plot.
- Title Color:** Black.  Add file name to title.
- Font type:** Arial. Callout: Plot Font type and Font size (small, medium, or large). Plot Data displays example of font type to right of selection. List of fonts depends on what fonts are installed on your computer.
- Font size:** Small.
- Grid lines:** Horizontal and Vertical. Callout: Grid lines (none, horizontal and vertical, horizontal, vertical). Grid style (solid, dotted, or dashed line), and whether to place Grid in front of plotted data.
- Grid style:** Thin Solid Line.  Grid in front.
- Inside Background Color:** White. **Outside Background Color:** White. Callout: Inside Background Color defines color within axes. Outside Background Color defines color outside axes.
- Symbol size:** Small. **Symbol frequency:** 6. Callout: Symbol plotting frequency (0 = least frequent, 9 = most frequent), if Monochrome plot selected. If too frequent, symbols create illusion of very thick line, making details difficult to see.
- Monochrome plot.  Plot symbols only.  Show line legends.
- Mark data points.  Show plot shadow. Callout: Mark data points: Mark each individual data point with a dot, and connect dots. If not selected, Plot Data just draws a continuous line between data points. Show plot shadow: Create shadow effect to bottom and right of axes.
- Auto range padding %:** 5. Callout: Space between axes and maximum and minimum plotted values, if Auto range selected on Axis tabs. For 0%, maximum and minimum values plot on axes.
- Process Options...** Callout: Select number of wave bursts or tide scans to process and number to skip at start of data file. Default is to process all data.
- Buttons:** Start Process, Exit, Cancel. Callout: Click Start Process to begin processing data. Status field shows Processing complete when done. Callout: Return to SEASOFT for Waves window. If Confirm Program Setup Change was selected in Options menu - If you made changes and did not Save or Save As, program asks if you want to save changes. If Confirm Program Setup Change was not selected in Options menu - This says Save & Exit. If you do not want to save changes, click Cancel to exit.

## X Axis Tab

The X Axis tab defines the plot style as well as the X axis variable, scale, and line type.

The X Axis tab looks like this for **Wave Time Series**, **Tide Time Series**, or **Wave Statistics**:

The screenshot shows the 'Plot Data' dialog box with the 'X Axis' tab selected. The 'Variable' is set to 'Time [seconds]'. The 'Plot Style' is set to 'Overlay'. The 'Line type' is 'Thin Solid', 'Line Color' is green, and 'Line symbol' is 'Solid Circle'. The 'Auto range' and 'Auto divisions' options are checked. The 'Start Process', 'Exit', and 'Cancel' buttons are at the bottom.

**Selection dependent on Plot type selected on Plot Setup tab:**

- Wave Time Series – time (seconds)
- Tide Time Series – date and time
- Wave Statistics – burst number or date and time

**Plot Style:**

- *Overlay* – overlay plot for all Y axis variables on one plot, or
- *Stacked* - create a separate plot for each Y axis variable, with plots stacked vertically above each other.

Select to label axis with variable name as listed in drop down Variable list, or enter Custom label for axis.

Label axis with variable name

Custom label

Select desired line type, color, and symbol. Selection of color or monochrome plot, and inclusion of symbols in plot, is made on Plot Setup tab, and applies to all axes.

Line type: Thin Solid

Line Color:

Line symbol: Solid Circle

- *Auto range* - Plot Data selects axis Minimum and Maximum values, number of Major divisions on axis, and number of Minor divisions between Major divisions.
- *Auto divisions* - Plot Data selects number of major divisions on axis, and number of minor divisions between major divisions. User selects axis Minimum and Maximum values. Any values that fall outside user-selected Minimum to Maximum range will plot at minimum or maximum, as applicable.

Auto range

Minimum: 0.0000

Maximum: 10.0000

Auto divisions

Major: 4

Minor: 1

Click **Start Process** to begin processing data. Status field shows *Processing complete* when done.

Return to SEASOFT for Waves window.

- If *Confirm Program Setup Change* was selected in Options menu - If you made changes and did not Save or Save As, program asks if you want to save changes.
- If *Confirm Program Setup Change* was not selected in Options menu - This says **Save & Exit**. If you do not want to save changes, click Cancel to exit.



The X Axis tab looks like this for **Auto Spectrum**:

**Plot Data**

File Options Help

File Setup Plot Setup X Axis Y Axis 1

Variable: Frequency [Hz]

Plot Style:  Overlay 2D  Overlay 3D

Include chi-squared confidence intervals

Display Burst Parameters

Label axis with variable name

Custom label: \_\_\_\_\_

Line type: Thin Solid

Line Color: [Green] Line symbol: Solid Circle

Auto range Minimum: 0.0000 Maximum: 10.0000

Auto divisions Major: 4 Minor: 1

Start Process Exit Cancel

Selection dependent on Plot type selected on Plot Setup tab:

- Auto Spectrum – frequency (Hz)

If selected, confidence intervals and burst parameters display in text at right of a 2D plot.

Select to label axis with variable name as listed in drop down Variable list, or enter a Custom label for axis.

- *Overlay 2D* – 2D plot of frequency and energy density
- *Overlay 3D* – 3D plot of frequency, energy density, and either burst number or date and time

Select desired line type, color, and symbol. Selection of color or monochrome plot, and inclusion of symbols in plot, is made on Plot Setup tab, and applies to all axes.

- *Auto range* - Plot Data selects axis Minimum and Maximum values, number of Major divisions on axis, and number of Minor divisions between Major divisions.
- *Auto divisions*: - Plot Data selects number of major divisions on axis, and number of minor divisions between major divisions. User selects axis Minimum and Maximum values. Any values that fall outside user-selected Minimum to Maximum range will plot at minimum or maximum, as applicable.

Click **Start Process** to begin processing data. Status field shows *Processing complete* when done.

Return to SEASOFT for Waves window.

- If *Confirm Program Setup Change* was selected in Options menu - If you made changes and did not Save or Save As, program asks if you want to save changes.
- If *Confirm Program Setup Change* was not selected in Options menu - This says **Save & Exit**. If you do not want to save changes, click Cancel to exit.

## Y Axis Tab

The Y Axis tabs define the Y axis variables, scales, and line types.

Include this axis in plot. Plot Data can plot 1 X and up to 4 Y axes. At least 1X and 1 Y variable is required, so this selection is available only on Y Axis 2, 3, and 4.  
Note: If you deselect an axis, all axes numbered *above* that axis are automatically deselected.

Select to label axis with variable name as listed in drop down Variable list, or enter a Custom label for axis.

- *Auto range* - Plot Data selects axis Minimum and Maximum values, number of Major divisions on axis, and number of Minor divisions between Major divisions.
- *Auto divisions* - Plot Data selects number of major divisions on axis, and number of minor divisions between major divisions. User selects axis Minimum and Maximum values.

Any values that fall outside user-selected Minimum to Maximum range plot at minimum or maximum, as applicable.

Selection dependent on Plot type selected on Plot Setup tab.

Select desired line type, color, and symbol. Selection of color or monochrome plot, and inclusion of symbols in plot, is made on Plot Setup tab, and applies to all axes.

Click **Start Process** to begin processing data. Status field shows *Processing complete* when done.

Return to SEASOFT for Waves window.

- If *Confirm Program Setup Change* was selected in Options menu - If you made changes and did not Save or Save As, program asks if you want to save changes.
- If *Confirm Program Setup Change* was not selected in Options menu - This says **Save & Exit**. If you do not want to save changes, click Cancel to exit.



## Viewing and Outputting Plots

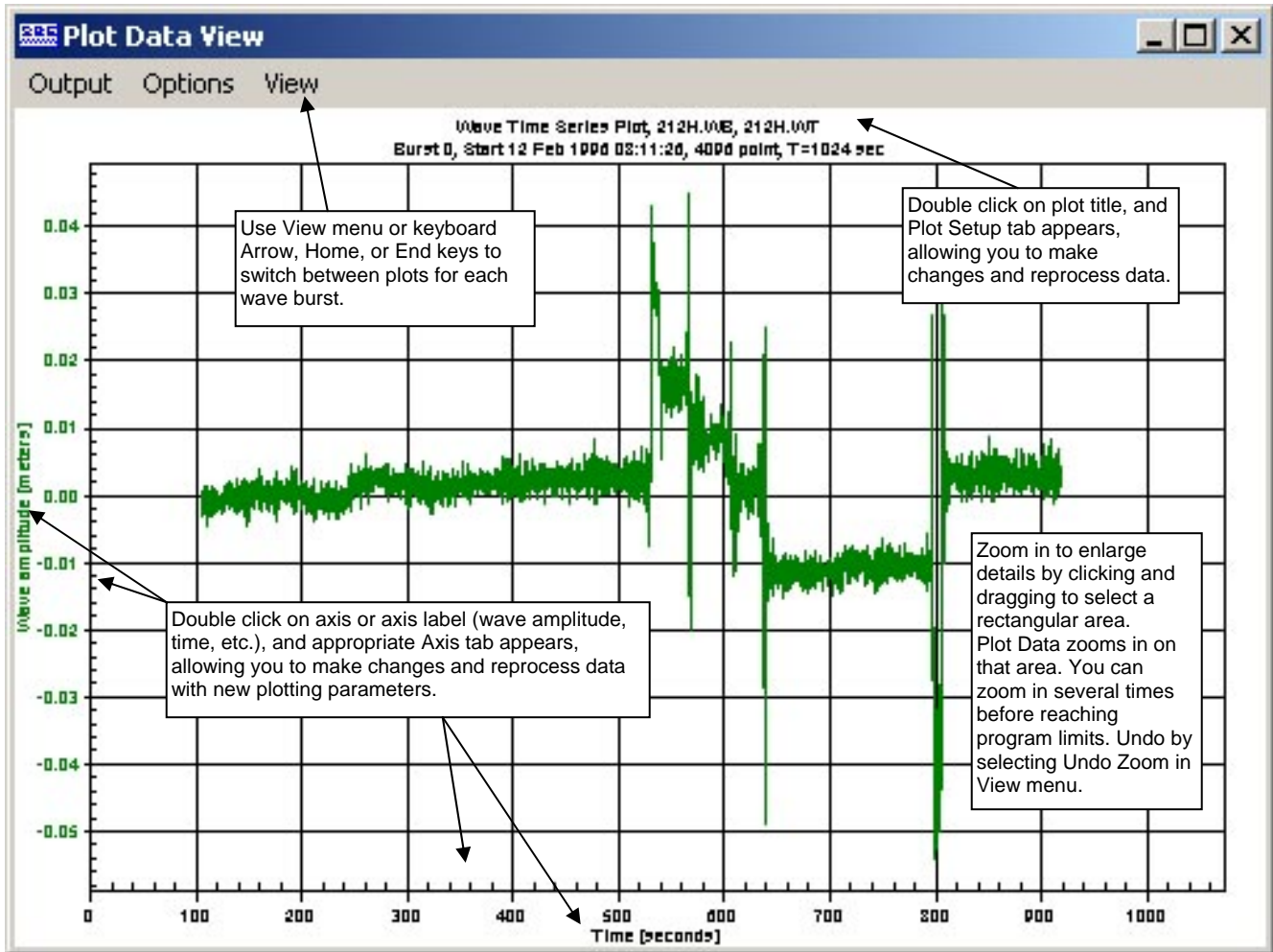

The Plot Data View window's menus are described below:

**Output** – Output the plot to printer, clipboard, or a file.

- **Print** – Print the single plot that is displayed on screen. In the dialog box, select printer, orientation, color, etc.; these selections override selections you made in Plot Data and in the Plot Data View **Options** menu.
- **File** – Output to file the single plot that is displayed on screen, in the selected format (.wmf, .jpg, or .bmp). In the dialog box, select the desired directory and output file name; these selections override selections you made in Plot Data and in the Plot Data View **Options** menu.
- **Clipboard** – Output to the clipboard the single plot that is displayed on screen, in the selected format (.wmf, .jpg, or .bmp). The selected format overrides the selection you made in the Plot Data View **Options** menu.
- **Print Range** (for wave time series and auto spectrum plots) – Print plots for several wave bursts for the series that is displayed on screen. In the dialog box, select the wave burst print range. Orientation and size are as selected in the Plot Data View **Options** menu. Plots output to your system's default printer; to output to a different printer you must select a new default printer before you select **Print Range**.
- **File Range** (for wave time series and auto spectrum plots) – Output to file the plots for several wave bursts for the series that is displayed on screen, in the selected format (.wmf, .jpg, or .bmp). In the dialog boxes, select the wave burst file output range, and the desired directory and output file name. Directory and file name selections override selections you made in Plot Data and in the Plot Data View **Options** menu.

**Notes:**

- The first wave burst is labeled 0.
- To change the default printer in Windows XP: Click Start / Printers and Faxes. A list of printers installed on your system appears, with a check mark next to the default printer. Right click on the desired printer, and select **Set as Default Printer**.

**Options** – Sets up defaults for *how* the plot is output to the printer, file, or clipboard.

- *Print* –
  - Orientation – landscape, portrait, or (printer) driver default. If driver default is selected, orientation is determined by the default for the printer you select in Output / Print (if printing a single plot) or the system default printer (if printing multiple plots using Output / Print Range).
  - Print full page – If selected, scale plot to fit 8 ½ x 11 inch page. If not selected, Size determined by - Plot Data View Dimensions – plot dimensions as shown on screen. Values Entered Below – Units, Width, and Height entered here.
- *File* –
  - Data format – Metafile (.wmf), Jpeg (.jpg), or Bitmap (.bmp).
  - Size determined by - Plot Data View Dimensions – plot dimensions as shown on screen. Values Entered Below – Units, Width, and Height entered here.
- *Clipboard* –
  - Data format – Metafile (.wmf), Jpeg (.jpg), or Bitmap (.bmp).
  - Size determined by - Plot Data View Dimensions – plot dimensions as shown on screen. Values Entered Below – Units, Width, and Height entered here.

**View** – Sets up viewing options.

- *First Burst, Last Burst, Next Burst, Prior Burst, Go to Burst* (applicable to wave time series and auto spectrum plots) – Switch the plot on screen to a different wave burst.
- *Undo Zoom* –Return the plot to the original ranges specified on the Axis tabs. *Undo Zoom* is grayed out unless you have zoomed in (by clicking and dragging to select a rectangular area) to enlarge details.
- *Set Zoomed Ranges* – Substitute the current zoomed ranges of the plot for the Minimum and Maximum plot ranges on the Axis tabs. This allows you to save the ranges of the zoomed view, so you can go to exactly the same view the next time you run Plot Data. *Set Zoomed Ranges* is grayed out unless you have zoomed in (by clicking and dragging to select a rectangular area) to enlarge details.

# Section 10: Routine Maintenance and Calibration

This section reviews corrosion precautions, connector mating and maintenance, battery replacement, pressure sensor maintenance, optional conductivity cell storage and cleaning, and sensor calibration. The accuracy of the SBE 26plus is sustained by the care and calibration of the sensors and by establishing proper handling practices.

---

## Corrosion Precautions

Rinse the SBE 26plus with fresh water after use and prior to storage.

The SBE 26plus has a plastic housing with a titanium end cap. No corrosion precautions are required, but avoid direct electrical connection of the titanium end cap to dissimilar metal hardware.

The optional SBE 4M conductivity cell has a titanium housing. No corrosion precautions are required, but avoid direct electrical connection of the titanium to dissimilar metal hardware.

---

## Connector Mating and Maintenance

**Note:**

See *Application Note 57: Connector Care and Cable Installation*.

Clean and inspect connectors, cables, and dummy plugs before every deployment and as part of your yearly equipment maintenance. Inspect connectors that are unmated for signs of corrosion product around the pins, and for cuts, nicks or other flaws that may compromise the seal.

When remating:

**CAUTION:**

**Do not use WD-40** or other petroleum-based lubricants, as they will damage the connectors.

1. Lightly lubricate the inside of the dummy plug/cable connector with silicone grease (DC-4 or equivalent).
2. **Standard Connector** - Install the plug/cable connector, aligning the raised bump on the side of the plug/cable connector with the large pin (pin 1 - ground) on the 26plus. Remove any trapped air by *burping* or gently squeezing the plug/connector near the top and moving your fingers toward the end cap. **OR**  
**MCBH Connector** – Install the plug/cable connector, aligning the pins.
3. Place the locking sleeve over the plug/cable connector. Tighten the locking sleeve finger tight only. **Do not overtighten the locking sleeve and do not use a wrench or pliers.**

Verify that a cable or dummy plug is installed for each connector on the system before deployment.

## Battery Replacement



Alkaline D-cell  
(MN1300, LR20)

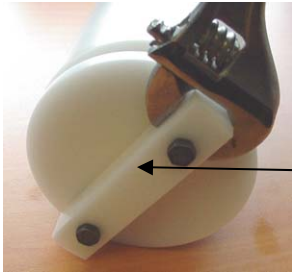

Unthread cap by  
rotating counter-  
clockwise

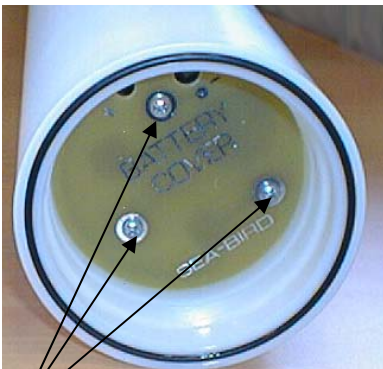

Remove Phillips-head  
screws and washers

Note: Alkaline and lithium batteries require different cover plates, because 1 lithium DD cell is shorter than 2 alkaline D cells.



For lithium DD cells

For alkaline D cells

The SBE 26plus uses 12 alkaline D-cells (Duracell MN1300, LR20) or 6 lithium DD-cells (Electrochem BCX85-3B76-TC), dropped into the battery compartment.

Leave the batteries in place when storing the 26plus to prevent depletion of the back-up lithium batteries by the real-time clock. Even *exhausted* main batteries power the clock (less than 25 microamperes) almost indefinitely. If the 26plus is to be stored for long periods, **replace the batteries yearly to prevent battery leakage** (which could damage the 26plus).

1. Remove the battery end cap (end cap without connectors):
  - A. Wipe the outside of the end cap and housing dry, being careful to remove any water at the seam between them.
  - B. Remove the end cap by rotating counter-clockwise (use a wrench on the white plastic bar if necessary).
  - C. Remove any water from the O-ring mating surfaces inside the housing with a lint-free cloth or tissue.
  - D. Put the end cap aside, being careful to protect the O-ring from damage or contamination.
2. Remove the battery cover plate from the housing:
  - A. Remove the three Phillips-head screws and washers from the battery cover plate inside the housing.
  - B. The battery cover plate will pop out. Put it aside.
3. Turn the 26plus over and remove the batteries.
4. Install the new batteries, with the + terminals against the flat battery contacts and the - terminals against the spring contacts.
5. Reinstall the battery cover plate in the housing:
  - A. Align the battery cover plate with the housing. The posts inside the housing are not placed symmetrically, so the cover plate fits into the housing only one way. Looking at the cover plate, note that one screw hole is closer to the edge than the others, corresponding to the post that is closest to the housing.
  - B. Reinstall the three Phillips-head screws and washers, while pushing hard on the battery cover plate to depress the spring contacts at the bottom of the battery compartment. **The screws must be fully tightened, or battery power to the circuitry will be intermittent.**
6. Check the battery voltage at BAT + and BAT - on the battery cover plate. For standard alkaline D cell batteries, it should be approximately 18 volts. For lithium DD cell batteries, it should be approximately 21 volts.
7. Reinstall the battery end cap:
  - A. Remove any water from the O-rings and mating surfaces with a lint-free cloth or tissue. Inspect the O-rings and mating surfaces for dirt, nicks, and cuts. Clean or replace as necessary. Apply a light coat of o-ring lubricant (Parker Super O Lube) to O-rings and mating surfaces.
  - B. Carefully fit the end cap into the housing and screw the end cap into place. Use a wrench on the white plastic bar to ensure the end cap is tightly secured.

## Pressure Sensor Maintenance

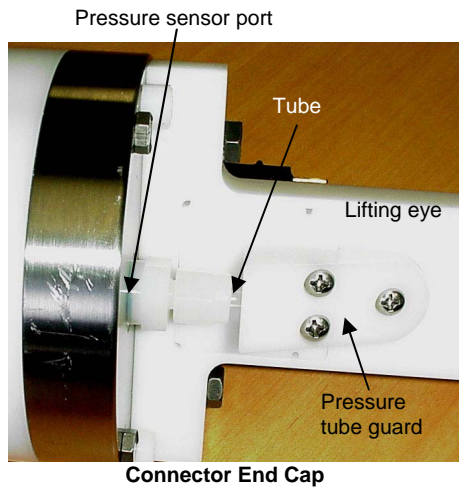

The pressure fitting – which includes a pressure port fitting, external tube, and polyurethane bladder bag – is filled with silicone oil at the factory. The oil transmits hydrostatic pressure via internal, capillary tubing to the pressure sensor inside the instrument, and prevents corrosion that might occur if the sensor diaphragm was exposed to water. The bladder bag is vacuum back-filled.

The bladder bag can develop tears and leaks over time. If the fitting has been damaged, or investigation due to poor data shows that the bag has torn, replace the fitting and bag and refill the oil. **Sea-Bird highly recommends that you send the SBE 26plus back to the factory for this repair, as it is difficult to completely remove all air from the system in the field, resulting in potential pressure errors.** However, if you must do the repair to meet a deployment schedule, contact Sea-Bird to purchase the needed parts.

Parts required:

Part Number	Description	Quantity
30551	Pressure port bladder bag	2 *
50025	Pressure sensor oil refill kit (provided with 26plus shipment)**	1
50029	Nylon capillary assembly	2 *
30002	Swagelock, nylon, NY-200-1-OR	2 *
30521	Syringe, 60 cc, DURR #899069, MFG #309663 (18 gage needle ground)	1

\* Only 1 is required, but we recommend that you purchase a spare in case you have difficulty with the procedure.

\*\* If you have a bell jar, use it to de-gas the oil in the oil refill kit.

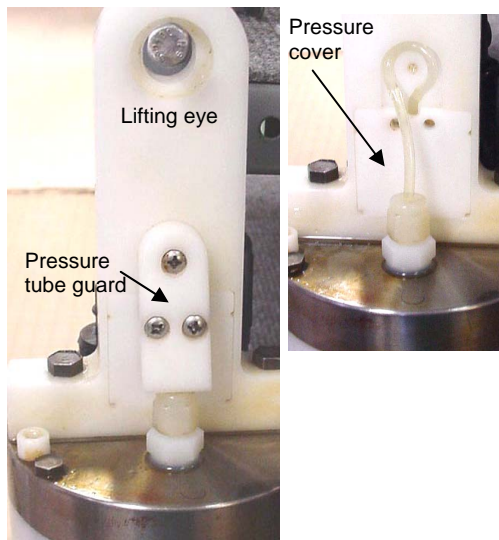

1. Securely mount the 26plus vertically (connector end cap up).
2. Remove the 3 Phillips-head screws attaching the pressure tube guard to the lifting eye. Remove the pressure tube guard and the pressure cover that is under it.

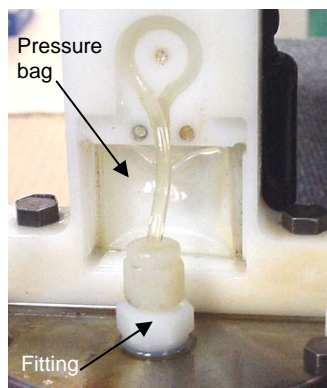

3. Remove the fitting from the end cap with a 9/16 inch wrench. Discard the fitting, tubing, and pressure bag.



**CAUTION:**  
Do not put a brush or any object in the pressure port. Doing so may damage or break the pressure sensor.

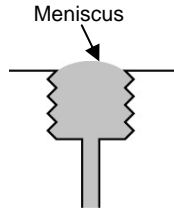

4. Clean the pressure bag cavity in the lift eye and the removed pressure tube guard and pressure cover, removing all residue/grit. Ensure that the holes in each corner of the pressure bag cavity in the lift eye are free of obstructions.
5. Clean the sensor end cap, being careful to remove any residue/grit near the pressure port.
6. From the 50025 pressure sensor oil refill kit, fill the small syringe with the supplied oil. Fill the pressure port, forming a meniscus on the surface of the end cap. Keep the SBE 26plus in the vertical position for at least 30 minutes before proceeding, to allow any bubbles in the internal plumbing to rise to the surface. Add oil from the small syringe as necessary to maintain the meniscus.

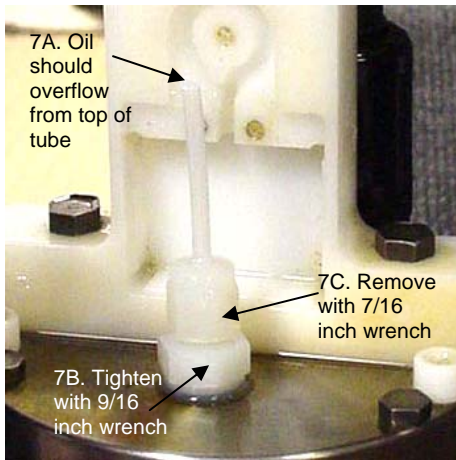

7. Install the supplied capillary fitting (50029) in the pressure port.
  - A. As the fitting is installed, oil should rise the length of the tube and overflow. Wipe up the excess oil with a paper towel.
  - B. Gently tighten the lower portion of the fitting with a 9/16 inch wrench - **DO NOT OVERTIGHTEN**.
  - C. Remove the upper portion of the capillary fitting and tube using a 7/16 inch wrench. Store it for possible use another time.
8. Using the small syringe, add oil to the lower portion of the fitting, forming a meniscus.

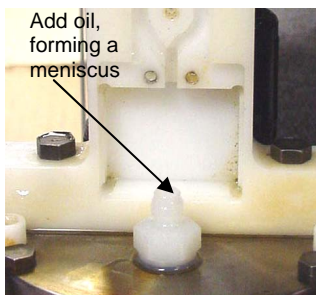

9. Fill the large syringe (30521) ¼ full with oil.

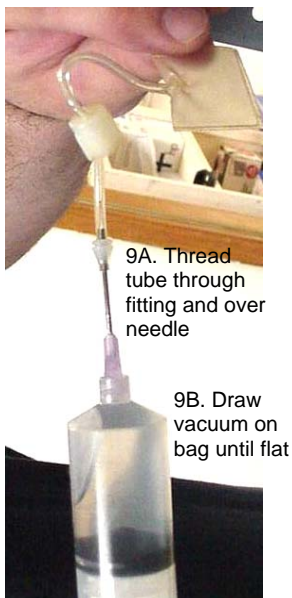

- A. Thread the tube from the pressure bag (30551) through the Swagelock fitting (30002), and install the pressure bag tube over the needle.
- B. Pull the plunger back on the syringe, drawing a vacuum on the pressure bag until it is completely flat. Maintain the vacuum on the bag.
- C. Hold the syringe vertically with the bag down and slowly release the plunger, allowing the vacuum to be released. The bag should slowly fill with oil. There is enough oil in the bag when the bag looks like a *small pillow*. It is very important that there are no air bubbles in the pressure bag; you may have to perform this step several times to ensure that there are no bubbles.

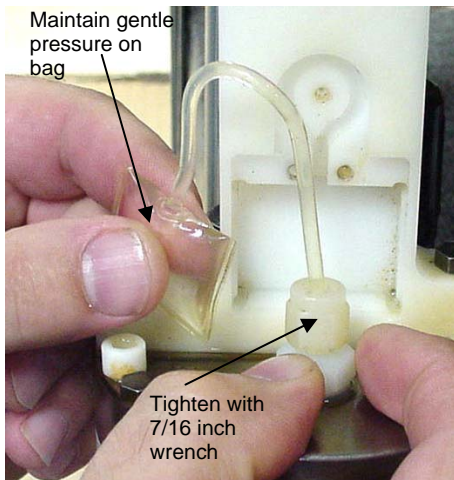

10. After the bag is filled, gently remove the tube from the needle, keeping the bag at or below the level of the end of the tube to prevent air from entering the bag. Maintaining gentle pressure on the bag to keep the oil at the end of the tube and prevent air from entering the bag, insert the end of the tube into the lower portion of the fitting on the end cap and screw the Swagelok fitting down, using a 7/16 inch wrench. Oil should overflow from the fitting, preventing air from entering the bag; the overflow should stop when the fitting is tightened. When completed, the bag should be approximately 1/2 full of oil and contain no air.

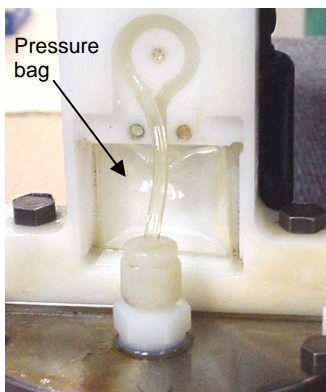

11. Install the pressure bag in the pressure bag cavity. Place the tubing in the indent, going counter-clockwise from the bag to the fitting.

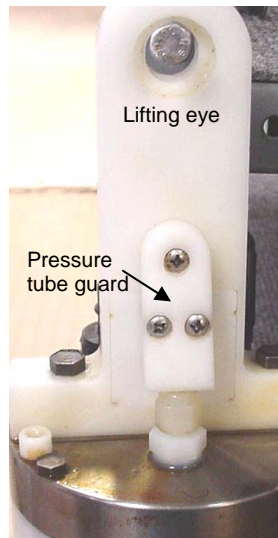

12. Reinstall the pressure cover, pressure tube guard, and 3 Phillips-head screws, being careful not to pinch the tubing or the bag.

13. Log data on the SBE 26plus, and download the data. Compare the pressure readings to a local barometer. A pinched or overfilled bag will give pressure readings that are higher than the correct values.

## Conductivity Cell Maintenance

**CAUTIONS:**

- **Do not put a brush or any object inside the conductivity cell to dry it or clean it.** Touching and bending the electrodes can change the calibration. Large bends and movement of the electrodes can damage the cell.
- **Do not store the SBE 4M with water in the conductivity cell.** Freezing temperatures (for example, in Arctic environments or during air shipment) can break the cell if it is full of water.

The SBE 26plus' optional conductivity cell (SBE 4M) is shipped dry to prevent freezing in shipping. **Refer to *Application Note 2D: Instructions for Care and Cleaning of Conductivity Cells* for conductivity cell cleaning procedures and cleaning materials.**

- The Active Use (after each cast) section of the application note is not applicable to the SBE 4M, which is intended for use as a moored instrument.



## Sensor Calibration

### Note:

After recalibration of the pressure, temperature, and/or optional conductivity sensor, Sea-Bird enters the new calibration coefficients in the 26plus EEPROM, and ships the instrument back to the user with Calibration Certificates showing the new coefficients. For the conductivity sensor, Sea-Bird also provides the user with an updated .psa file (for use in Convert Hex).

### Note:

Although the pressure sensor manufacturer can re-calibrate the pressure sensor by duplicating the original procedures, the sensor must be removed from the 26plus, the cost is relatively high, and lead times can be considerable.

Sea-Bird sensors are calibrated by subjecting them to known physical conditions and measuring the sensor responses. Coefficients are then computed, which may be used with appropriate algorithms to obtain engineering units. The pressure, temperature, and optional conductivity sensors on the SBE 26plus are supplied fully calibrated, with coefficients printed on their respective Calibration Certificates (in manual).

We recommend that the 26plus be returned to Sea-Bird for calibration.

## Pressure Sensor Calibration

The pressure sensor is capable of meeting the 26plus error specification with some allowance for aging and ambient-temperature induced drift.

The pressure sensor coefficients are entered into the 26plus EEPROM with the calibration coefficient commands. The coefficients can be viewed using DC in SeatermW. Values for slope (default = 1.0) and offset (default = 0.0) can be entered in Convert Hex's Coefficient Configuration dialog box to make small post-deployment corrections for sensor drift. Note that the offset entered in Convert Hex is *in addition to* the offset entered in the 26plus EEPROM. Techniques are provided below for making small corrections using the slope and offset terms by comparing 26plus pressure output to:

- Readings from a barometer
- Readings from a dead-weight pressure generator – provides more accurate results, but requires equipment that may not be readily available

Before using either of these procedures, allow the 26plus to equilibrate (with power on) in a reasonably constant temperature environment for at least 5 hours before starting. Pressure sensors exhibit a transient change in their output in response to changes in their environmental temperature. Sea-Bird instruments are constructed to minimize this by thermally decoupling the sensor from the body of the instrument. However, there is still some residual effect; allowing the 26plus to equilibrate before starting will provide the most accurate calibration correction.

### Calculating Offset using a Barometer

1. Place the 26plus in the orientation it will have when deployed.
2. In SeatermW, connect to the 26plus.
3. **Quartz pressure sensor:** Send **FR** to display the pressure and pressure sensor temperature compensation frequencies. Click Stop to end the test. Compute pressure in psia from the frequencies with the formula shown on the calibration sheet.
4. **Strain Gauge pressure sensor:** Send **TS** a number of times to measure pressure (as well as pressure temperature and optional conductivity) and transmit converted data in engineering units (pressure in psia).
5. Compare the 26plus output to the reading from a good barometer. Calculate *Offset* = barometer reading – 26plus reading.
6. Enter the calculated offset (positive or negative) in Convert Hex's Coefficients Configuration dialog box.

#### Offset Correction Example – Quartz Pressure Sensor

Pressure measured by barometer is 1010.50 mbar. Pressure calculated from 26plus pressure frequency is 14.06 psia.  
 Convert barometer reading to psia using relationship:  $\text{mbar} * 0.01 \text{ dbar/mbar} * 1 \text{ psia} / 0.689476 \text{ dbar} = \text{psia}$   
 Barometer reading =  $1010.50 \text{ mbar} * 0.01 / 0.689476 = 14.66 \text{ psia}$        $\text{Offset} = 14.66 - 14.06 = +0.60 \text{ psia}$   
 Enter offset in Convert Hex's Coefficient Configuration dialog box.

### Calculating Slope and Offset using a Dead-Weight Pressure Generator

Tests show that room-temperature-derived *slope* and *offset* corrections to the initial quartz calibration can account for long-term drift to within less than 0.01% of the sensor's full scale range. To perform this correction:

1. Use a suitable dead-weight pressure generator to subject the sensor to increments of known pressures. The end cap's  $\frac{5}{16}$ -24 straight thread permits mechanical connection to a pressure source. Use a fitting that has an o-ring face seal, such as Swagelok-200-1-OR. See *Application Note 12-1: Pressure Port Oil Refill Procedure & Nylon Capillary Fitting Replacement*.
2. In SeatermW, connect to the 26plus.
3. **Quartz pressure sensor:** Send **FR** to display the pressure and pressure sensor temperature compensation frequencies. Click Stop to end the test. Compute pressure in psia from the frequencies with the formula shown on the calibration sheet.
4. **Strain Gauge pressure sensor:** Send **TS** a number of times to measure pressure (as well as pressure temperature and optional conductivity) and transmit converted data in engineering units (pressure in psia).
5. Enter the calculated slope and offset (positive or negative) in Convert Hex's Coefficient Configuration dialog box.

#### *Pressure Slope and Offset Correction Example – Quartz Pressure Sensor*

A 45 psia sensor has drifted and its responses are low, as shown below:

Actual Pressure (psia)	Indicated Pressure (psia)
0.000	-0.057
9.000	8.939
18.000	17.936
27.000	26.932
36.000	35.929
45.000	44.925

Linear regression (best straight-line fit)  $p_{corrected} = (p_{indicated} * slope) + offset$

yields  $slope = +1.00039381$  and  $offset = +0.057$ . Enter these correction coefficients, originally set to 1.0 and 0.0 respectively, in Convert Hex's Coefficient Configuration dialog box.

### Temperature Sensor Calibration

The primary source of temperature sensor calibration drift is the aging of the thermistor element. Sensor drift is usually a few thousandths of a degree during the first year, and less in subsequent intervals. Sensor drift is not substantially dependent upon the environmental conditions of use, and — unlike platinum or copper elements — the thermistor is insensitive to shock.

The temperature sensor coefficients are entered into the 26plus EEPROM with the calibration coefficient commands. The coefficients can be viewed using **DC** in SeatermW.

**Note:**  
Temperature sensor calibration coefficients in Convert Hex's Coefficient Configuration dialog box are ignored (software will be updated in future to eliminate these entries from dialog box).

## Conductivity Sensor Calibration

The optional SBE 4M conductivity sensor incorporates a fixed precision resistor in parallel with the cell. When the cell is dry and in air, the sensor's electrical circuitry outputs a frequency representative of the fixed resistor. This frequency is recorded on the Calibration Certificate and should remain stable (within 1 Hz) over time.

The conductivity sensor calibration certificate shows the following coefficients: g, h, i, j, Cpcor, and Ctcor. View and/or modify these coefficients in Convert Hex's Coefficient Configuration dialog box and in the 26plus EEPROM.

- Cpcor makes a correction for the highly consistent change in dimensions of the conductivity cell under pressure. The default is the compressibility coefficient for borosilicate glass ( $-9.57 \times 10^{-8}$ ). Some sensors fabricated between 1992 and 1995 (serial numbers between 1100 and 1500) exhibit a compression that is slightly less than pure borosilicate glass. For these sensors, the (hermetic) epoxy jacket on the glass cell is unintentionally strong, creating a composite pressure effect of borosilicate and epoxy. For sensors tested to date, this composite pressure coefficient ranges from  $-9.57 \times 10^{-8}$  to  $-6.90 \times 10^{-8}$ , with the latter value producing a correction to deep ocean salinity of 0.0057 PSU in 5000 dbars pressure (approximately 0.001 PSU per 1000 dbars). Before modifying Cpcor, confirm that the sensor behaves differently from pure borosilicate glass. Sea-Bird can test your cell and calculate Cpcor. Alternatively, test the cell by comparing computed salinity to the salinity of water samples from a range of depths, calculated using an AutoSal.

Enter the value for slope (default = 1.0) in the SBE 26plus EEPROM to make small corrections for conductivity sensor drift between calibrations:

Corrected conductivity = (slope \* computed conductivity)

where

slope = true conductivity span / instrument conductivity span

**Note:**

See Application Note 31 for computation of slope correction coefficient from pre- and post-cruise calibrations supplied by Sea-Bird or from salinity bottle samples taken at sea during profiling.

*Conductivity Slope and Offset Correction Example*

At true conductivity = 3.5 S/m, instrument reading = 3.49965 S/m

Calculating the slope:

Slope =  $3.5 / 3.49965 = +1.0001000100010001000100010001$

The primary mechanism for calibration drift in conductivity sensors is the fouling of the cell by chemical or biological deposits. Fouling changes the cell geometry, resulting in a shift in cell constant (slope of the calibration curve), typically resulting in lower conductivity readings over time. Offset error (error at 0 S/m) is usually due to electronics drift, and is typically less than  $\pm 0.0001$  S/m per year. Because offsets greater than  $\pm 0.0002$  S/m are a symptom of sensor malfunction, Sea-Bird recommends that drift corrections be made by assuming no offset error, unless there is strong evidence to the contrary or a special need.

The most important determinant of long-term sensor accuracy is the cleanliness of the cell. We recommend that the conductivity sensors be calibrated before and after deployment, but particularly when the cell has been exposed to contamination by oil slicks or biological material.

# Section 11: Troubleshooting

This section reviews common problems in operating the SBE 26plus, and provides the most common causes and solutions.

---

## Problem 1: Unable to Communicate with SBE 26plus

The `S>` prompt indicates that communications between the SBE 26plus and computer have been established. Before proceeding with troubleshooting, attempt to establish communications again by clicking Connect in SeatermW or hitting the Enter key several times.

**Cause/Solution 1:** The I/O cable connection may be loose. Check the cabling between the 26plus and computer for a loose connection.

**Cause/Solution 2:** The instrument, Comm port, and/or baud rate may not have been entered correctly in SeatermW. Click Configure and verify the settings.

**Cause/Solution 3:** The I/O cable may not be the correct one. The I/O cable supplied with the 26plus permits connection to the DB-9P input connector on a standard RS-232 interface.

- 26plus Pin 1 (large pin on standard connector) goes to DB-9 pin 5 (ground)
- 26plus pin 2 (counter-clockwise from pin 1) goes to DB-9 pin 3
- 26plus pin 3 (opposite pin 1) goes to DB-9 pin 2

**Cause/Solution 4:** If attempting to communicate with the 26plus after you started logging, the 26plus may be making a wave burst measurement. You cannot communicate with the 26plus while it is making a wave burst measurement. Wait until you think the wave burst is complete, and try to establish communications again. If you have programmed a long wave burst and need to establish communications now, press Esc to interrupt the wave burst (this interrupts the current wave burst but does not stop logging). The 26plus will fill out the remaining data in the interrupted wave burst with 0's.

### Note:

Interrupting a tide measurement and/or wave burst by pressing the Esc key will affect the quality of your data. For high quality data, Sea-Bird recommends the following to allow querying the 26plus during logging without interrupting measurements:

- Set sampling parameters with enough time between measurements, and
- Schedule/time queries when the 26plus is not measuring tides (of concern only for 26plus with Strain Gauge pressure sensor) or waves.

**Cause/Solution 5:** If attempting to communicate with the 26plus with **Strain Gauge** pressure sensor after you started logging, the 26plus may be making a tide measurement. You cannot communicate with the 26plus while it is making a tide measurement. Wait until you think the tide measurement is complete, and try to establish communications again. If you need to establish communications now, press Esc to interrupt the tide measurement (this interrupts the current tide measurement but does not stop logging). The 26plus will calculate the tide pressure based on the collected data.

**Cause/Solution 6:** In rare cases, the program that controls the 26plus microprocessor can be corrupted by a severe static shock or other problem. This program can be initialized by using the reset switch. Proceed as follows to initialize:

**Note:**

Using the reset switch does not affect the 26plus memory - data in memory and user-programmable parameter values are unaffected.

1. **As a precaution, upload all data before proceeding.**
2. Open the battery end cap and remove the batteries (see *Replacing Batteries* in *Section 10: Routine Maintenance and Calibration* for details).
3. There is a toggle reset switch on the battery compartment bulkhead, which is visible after the batteries are removed. The switch is used to disconnect the internal back-up lithium batteries from the electronics. Set the switch to the reset position for at least 5 minutes.
4. Reinstall or replace the batteries, and close the battery end cap.
5. Establish communications with the 26plus (see *Section 5: SBE 26plus Setup, Installation, and Data Upload - SeatermW* for details). Send the status command (**DS**) to verify that the setup is unaffected.

---

## Problem 2: Nonsense or Unreasonable Uploaded Data

The symptom of this problem is an uploaded file that contains unreasonable values (for example, values that are outside the expected range of the data).

**Cause/Solution 1:** An uploaded data file with unreasonable values for pressure, temperature, or optional conductivity may be caused by incorrect calibration coefficients in either of the following places:

- In instrument EEPROM - pressure, temperature, and conductivity sensor coefficients. View the coefficients by sending **DC** in SeatermW. If necessary, modify calibration coefficient(s) by sending the appropriate coefficient command(s) (see *Command Descriptions* in *Section 5: SBE 26plus Setup, Installation, and Data Upload - SeatermW*).
- In instrument .psa file used by Convert Hex – pressure sensor slope and offset (this offset is in addition to the offset programmed in the instrument EEPROM). View/modify the coefficients by clicking the Coefficients button in Convert Hex's dialog box.

Verify that the calibration coefficients match the instrument Calibration Certificates.

---

## Problem 3: Nonsense or Unreasonable Real-Time Data

**Note:**

If real-time or queried **pressure** values are unreasonable, note that a pressure slope and offset can be entered in Convert Hex's Coefficient Configuration dialog box to make small post-deployment corrections for pressure sensor drift on the uploaded data.

The symptom of this problem is real-time data that contains unreasonable values (for example, values that are outside the expected range of the data).

**Cause/Solution 1:** Real-time data with unreasonable values for pressure, temperature, or optional conductivity and salinity may be caused by incorrect pressure, temperature, and conductivity calibration coefficients in the instrument EEPROM. View the coefficients by sending **DC** in SeatermW; verify that the calibration coefficients match the instrument Calibration Certificates. If necessary, modify calibration coefficient(s) by sending the appropriate coefficient command(s) (see *Command Descriptions* in *Section 5: SBE 26plus Setup, Installation and Data Upload - SeatermW*).

# Glossary

**Battery and Memory Endurance** – SEASOFT for Waves module for calculating power endurance and memory endurance for a user-specified sampling scheme.

**Convert Hex** – SEASOFT for Waves module for converting uploaded .hex file into separate wave (.wb) and tide (.tid) files.

**Create Reports** – SEASOFT for Waves module for outputting one line of surface wave time series and/or wave burst auto-spectrum statistics for each processed wave burst.

**Extract Tide** – Program to split uploaded data from multiple deployments into separate files before converting and processing the data. ExtractTide.exe is not incorporated in SEASOFT for Waves' Run menu, but is automatically installed when you install SEASOFT for Waves, in the same directory as SEASOFT for Waves.

**Fouling** – Biological growth in the conductivity cell during deployment.

**Merge Barometric Pressure** – SEASOFT for Waves module for removing barometric pressure from tide data.

**PCB** – Printed Circuit Board.

**Plan Deployment** – SEASOFT for Waves module for calculating the ratio of pressure amplitude measured by the instrument to pressure amplitude at the surface, and predicting number of frequency bands calculated, width of each band, and frequency span.

**Plot Data** – SEASOFT for Waves module for plotting wave and tide data.

**Process Wave Burst Data**– SEASOFT for Waves module for computing wave statistics.

**SEAGAUGE** – High-accuracy wave and tide recorder with a quartz or strain gauge pressure sensor, precision thermometer, and optional SBE 4M conductivity sensor.

**SEASOFT for Waves - DOS** – Modular DOS program for use with the SBE 26. **SEASOFT for Waves –DOS is not compatible with the 26*plus*.**

**SEASOFT for Waves** – Modular Win 95/98/NT/2000/XP program for pre-deployment planning, communication with the 26*plus* for setup, uploading of data from the 26*plus*, separation of uploaded data into separate wave and tide files, removal of barometric pressure from tide data, statistical analysis, and data plotting. Modules include Plan Deployment, Battery and Memory Endurance, SeatermW, Convert Hex, Merge Barometric Pressure, Process Wave Burst Data, Create Reports, and Plot Data.

**SeatermW** – SEASOFT for Waves module for communication with the 26*plus* for setup and uploading of data from the 26*plus*.

**Super O-Lube** – Silicone lubricant used to lubricate O-rings and O-ring mating surfaces. Super O-Lube can be ordered from Sea-Bird, but should also be available locally from distributors. Super O-Lube is manufactured by Parker Hannifin ([www.parker.com/ead/cm2.asp?cmid=3956](http://www.parker.com/ead/cm2.asp?cmid=3956)).

**TCXO** – Temperature Compensated Crystal Oscillator.

**Triton X-100** – Reagent grade non-ionic surfactant (detergent), used for cleaning the conductivity cell. Triton can be ordered from Sea-Bird, but should also be available locally from chemical supply or laboratory products companies. Triton is manufactured by Mallinckrodt Baker (see [www.mallbaker.com/changecountry.asp?back=/Default.asp](http://www.mallbaker.com/changecountry.asp?back=/Default.asp) for local distributors).

# Appendix I: Command Summary

**Note:**

See *Command Descriptions* in Section 5: *SBE 26plus Setup, Installation, and Data Upload - SeatermW* for detailed information and examples.

CATEGORY	COMMAND	DESCRIPTION
Setup	<b>Status</b>	<b>DS</b> Display status and setup parameters.
	<b>SetTime</b>	Set real-time clock date and time.
	<b>DateTime=x</b>	<b>x</b> = real-time clock date and time. See <i>Setting Time in SBE 26plus to Synchronize Sampling of Multiple Instruments</i> in Section 5.
	<b>Baud=x</b>	<b>x</b> = baud rate for general communication (600, 1200, 2400, 4800, 9600, 19200, or 38400). Default 9600.
	<b>ExternalTemperature=x</b>	<b>x=Y</b> : Optional external thermistor. <b>x=N</b> : Standard internal thermistor. Default.
	<b>Conductivity=x</b>	<b>x=Y</b> : Enable conductivity logging (if optional conductivity sensor included). <b>x=N</b> : Do not.
	<b>UserInfo=x</b>	<b>x</b> = user-defined string. Displays in <b>DS</b> reply.
	<b>TxTide=x</b>	<b>x=Y</b> : Transmit real-time tide data. <b>x=N</b> : Do not.
	<b>TxWave=x</b>	<b>x=Y</b> : Transmit real-time wave data. Note: See <b>SetSampling</b> to transmit real-time wave statistics. <b>x=N</b> : Do not.
	<b>QS</b>	Enter quiescent (sleep) state. Main power turned off, memory retention unaffected.
Wave and Tide Setup	<b>SetSampling</b> (or <b>SetSample</b> )	Set tide and wave sampling parameters: <ul style="list-style-type: none"> <li>• Tide interval (1 – 720 minutes).</li> <li>• Tide duration (10 – 43,200 seconds).</li> <li>• Number of tide measurements between wave bursts (1 – 10,000).</li> <li>• Wave samples/burst – multiple of 4 (4 - 60,000). Set to power of 2 and minimum of 512 for meaningful wave statistics.</li> <li>• Wave sample duration – 0.25, 0.5, 0.75, or 1 second.</li> <li>• At receipt of <b>Start</b>, start logging at <b>SetStartTime</b> or immediately?</li> <li>• Stop logging at <b>SetStopTime</b> or wait for user to send <b>Stop</b>?</li> <li>• Calculate and output real-time wave statistics? If yes, <i>26plus</i> prompts for real-time wave statistics parameters.</li> </ul>
Initialize Logging (Reset Memory)	<b>InitLogging</b>	<b>After all data uploaded</b> , send this before starting to sample to make entire memory available for recording. If not sent, data stored after last sample.
	<b>TideCount=x</b>	<b>x</b> = tide sample number for first tide measurement when sampling begins. Use to recover data if you accidentally initialize logging before <b>ASCII</b> uploading.
	<b>*ByteCount=x</b>	<b>x</b> = byte number for first byte when sampling begins. Use to recover data if you accidentally initialize logging before <b>binary</b> uploading.
Logging	<b>Start</b>	Start logging now (if <i>use start time?</i> in <b>SetSampling</b> prompt is <i>No</i> ), or Start waiting to start logging (if <i>use start time?</i> in <b>SetSampling</b> is <i>Yes</i> ).
	<b>Stop</b>	Stop logging now.
	<b>SetStartTime</b>	Set date and time to start logging. At receipt of <b>Start</b> , <i>26plus</i> starts logging at this date and time if <i>Use start time?</i> in <b>SetSampling</b> is <i>Yes</i> .
	<b>SetStopTime</b>	Set date and time to stop logging. <i>26plus</i> stops logging at this date and time if <i>Use stop time?</i> in <b>SetSampling</b> is <i>Yes</i> .



**Note:**

Use the Upload menu to upload data that will be processed by SEASOFT for Waves. Manually entering a data upload command does not produce data in the required format for processing by SEASOFT for Waves.

CATEGORY	COMMAND	DESCRIPTION
<b>Send Last Sample</b>	<b>SL</b>	Send pressure, temperature, and salinity from last tide measurement and do not go to sleep (do not enter quiescent state).
	<b>SLO</b>	Send pressure, temperature, and salinity from last tide measurement and go to sleep (enter quiescent state).
<b>Data Upload</b>	<b>DD</b>	Upload data in <b>ASCII</b> at baud set for general communication with <b>Baud=</b> .
	<b>DBbaud,b,e</b>	Upload data in <b>binary</b> at <b>baud</b> (1200, 2400, 4800, 9600, 19200, 28800, 38400, 57600, or 115200) from byte <b>b</b> to <b>e</b> . First byte is 0. Can upload up to 500,000 bytes at one time.
	<b>ByteCount</b>	Display total number of bytes in memory.
<b>Diagnostic</b> (data from these tests not stored in FLASH memory)	<b>TS</b>	Take 1 sample of pressure, pressure temperature, temperature, and conductivity, and output <b>converted</b> data.
	<b>TSR</b>	Take 1 sample of pressure, pressure temperature, temperature, and conductivity, and output <b>raw</b> data.
	<b>TT</b>	Sample temperature, and output <b>converted</b> data. <i>26plus</i> runs continuously, drawing current. Press Esc key or click Stop to stop test.
	<b>TTR</b>	Sample temperature, and output <b>raw</b> data. <i>26plus</i> runs continuously, drawing current. Press Esc key or click Stop to stop test.
	<b>FR</b>	Measure and output frequencies: quartz pressure, quartz pressure temperature, and conductivity. <i>26plus</i> runs continuously, drawing current. Press Esc key or click Stop to stop test.
	<b>VR</b>	Measure and output: <ul style="list-style-type: none"> <li>• main battery voltage / 11.18</li> <li>• back-up lithium battery voltage / 4.8187</li> <li>• operating current (mA) / 20.04</li> <li>• ground voltage</li> </ul> <i>26plus</i> runs continuously, drawing current. Press Esc key or click Stop to stop test.
	<b>*FlashInit</b>	Map bad blocks and erase FLASH memory, <b>destroying all data</b> .
<b>*FlashGood</b>	Display number of good blocks in FLASH memory.	
<b>Calibration Coefficients</b> (F=floating point number; S=string with no spaces)  Dates shown are when calibrations were performed. Coefficients are initially factory-set and should agree with Calibration Certificates shipped with <i>26plus</i> .	<b>DC</b>	Display sensor calibration coefficients.
	<b>PCalDate=S</b>	S=pressure calibration date.
	<b>PU0=F</b>	F=quartz pressure U0.
	<b>PY1=F</b>	F=quartz pressure Y1.
	<b>PY2=F</b>	F=quartz pressure Y2.
	<b>PY3=F</b>	F=quartz pressure Y3.
	<b>PC1=F</b>	F=quartz pressure C1.
	<b>PC2=F</b>	F=quartz pressure C2.
	<b>PC3=F</b>	F=quartz pressure C3.
	<b>PD1=F</b>	F=quartz pressure D1.
	<b>PD2=F</b>	F=quartz pressure D2.
	<b>PT1=F</b>	F=quartz pressure T1.
	<b>PT2=F</b>	F=quartz pressure T2.
<b>PT3=F</b>	F=quartz pressure T3.	
<b>PT4=F</b>	F=quartz pressure T4.	

CATEGORY	COMMAND	DESCRIPTION
<b>Calibration Coefficients</b> <i>(continued)</i>	<b>PA0=F</b>	F= <i>strain gauge</i> pressure A0.
	<b>PA1=F</b>	F= <i>strain gauge</i> pressure A1.
	<b>PA2=F</b>	F= <i>strain gauge</i> pressure A2.
	<b>PTCA0=F</b>	F= <i>strain gauge</i> pressure PTCA0.
	<b>PTCA1=F</b>	F= <i>strain gauge</i> pressure PTCA1.
	<b>PTCA2=F</b>	F= <i>strain gauge</i> pressure PTCA2.
	<b>PTCB0=F</b>	F= <i>strain gauge</i> pressure PTCB0.
	<b>PTCB1=F</b>	F= <i>strain gauge</i> pressure PTCB1.
	<b>PTCB2=F</b>	F= <i>strain gauge</i> pressure PTCB2.
	<b>PTempA0=F</b>	F= <i>strain gauge</i> pressure PTempA0.
	<b>PTempA1=F</b>	F= <i>strain gauge</i> pressure PTempA1.
	<b>PTempA2=F</b>	F= <i>strain gauge</i> pressure PTempA2.
	<b>POffset=F</b>	F=pressure offset (psia) – applicable to both quartz and strain gauge pressure.
	<b>TCalDate=S</b>	S=temperature calibration date.
	<b>TA0=F</b>	F=temperature A0.
	<b>TA1=F</b>	F=temperature A1.
	<b>TA2=F</b>	F=temperature A2.
	<b>TA3=F</b>	F=temperature A3.
	<b>CCalDate=S</b>	S=conductivity calibration date.
	<b>CG=F</b>	F=conductivity G.
	<b>CH=F</b>	F=conductivity H.
	<b>CI=F</b>	F=conductivity I.
<b>CJ=F</b>	F=conductivity J.	
<b>CTCor=F</b>	F=conductivity TCor.	
<b>CPCor=F</b>	F=conductivity PCor.	
<b>CSlope=F</b>	F=conductivity slope correction.	

# Appendix II: Sample Timing

## General Sample Timing Notes

- When **Start** is sent:
  - If *Use start time?* in the **SetSampling** prompt is *No*, the 26plus starts logging 10 seconds after receipt of **Start**.
  - If *Use start time?* in the **SetSampling** prompt is *Yes*, the 26plus starts logging at **SetStartTime**.
- If *Use start time?* in the **SetSampling** prompt is *Yes*, and **SetStartTime** is less than 10 seconds in the future when **Start** is sent, the 26plus ignores the programmed start time and starts logging in 10 seconds.
- If *Use stop time?* in the **SetSampling** prompt is *Yes*, and **SetStopTime** is less than 1 hour after logging begins, the 26plus ignores the programmed stop time and continues logging until **Stop** is sent.
- Tides: The 26plus integrates the pressure sensor output over the entire tide duration, calculating and storing an average pressure for that time period. The 26plus measures the temperature and optional conductivity (T and C) associated with the tide *after* the tide duration. The time stamp (the time reported with the tide pressure, temperature, and conductivity data) is the time at the **beginning** of the tide duration.
- Waves: The time stamp (the time reported with wave burst data) is the time at the **beginning** of the wave burst.

## Sample Timing with Quartz Pressure Sensor

- If tide duration > (tide interval – 20 sec), tide duration is set to tide interval, and the 26plus samples tides continuously.

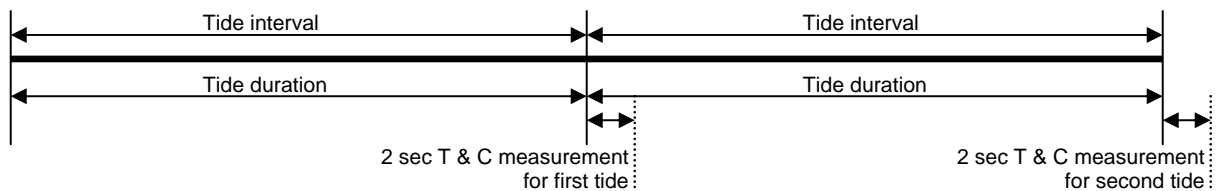

- If tide duration < (tide interval – 20 sec), 26plus goes to sleep between tide samples and wakes up and latches power onto the pressure sensor 10 sec before the start of the next tide sample.

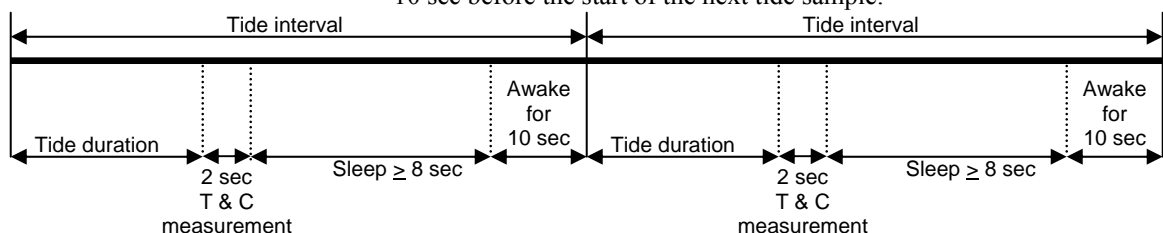

**Note:**

Sea-Bird recommends the following for meaningful wave statistics:

- Wave samples/burst  $\geq 512$ , and
- Wave samples/burst = power of 2 (512, 1024, etc.)

- If  $(\text{wave burst duration} + \text{real-time wave statistics calculation}) > (\text{tide interval} - 20 \text{ sec})$ , the 26plus increases the tide interval so that  $\text{wave burst duration} + \text{real-time wave statistics calculation} = (\text{tide interval} - 20 \text{ sec})$ . Note that real-time wave statistics can be calculated on a subset of the total number of wave samples/burst; the real-time statistics calculation requires 0.06 sec/wave sample to be processed.

The drawing only shows the relationship between the maximum allowable wave burst duration, real-time wave statistics calculation, and tide interval; see other drawings below for sequencing of wave and tide measurements.

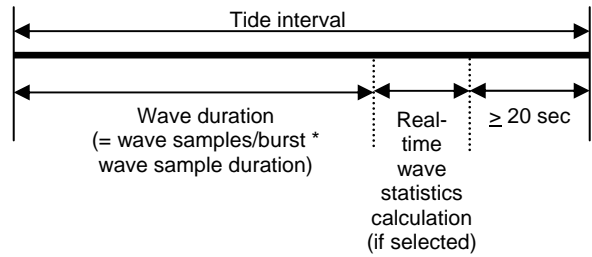

- If tide duration = tide interval, wave burst sampling is done during the applicable tide measurement, and the 26plus samples tides continuously. See Quartz Example 1.

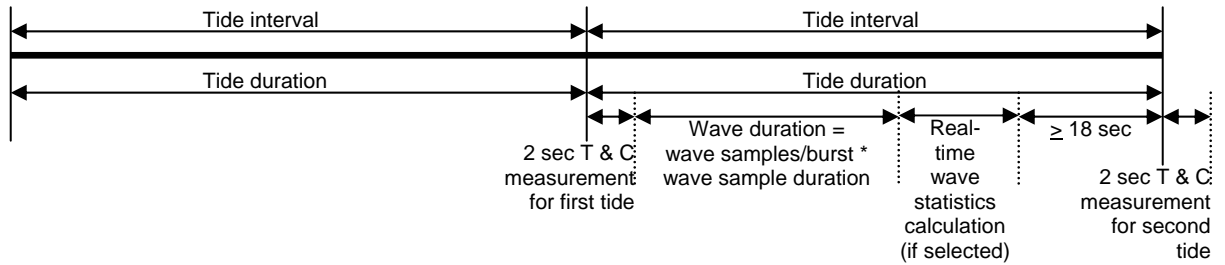

**Quartz Example 1:** Tide interval = tide duration = 15 minutes = 900 sec.

1024 samples/wave burst at 0.25 sec/sample (1024 x 0.25 = 256 sec) every 2 tide measurements.

Calculate real-time wave statistics on 512 samples/wave burst (512 x 0.06 sec/calculation = 30.7 sec required at end of wave burst).

Set **SetStartTime** to 12:00:00.

Checking setup:

$$\text{wave burst duration} + \text{real-time wave statistics calculation} = 256 + 30.7 = 287 \text{ sec} < \text{tide interval} - 20 \text{ sec} = 900 - 20 = 880 \text{ sec}$$

Time	Time Stamp for Tide #	Begin P for Tide #	End P for Tide #	Begin T & C for Tide #	End T & C for Tide #	Time Stamp for Wave Burst #	Begin Wave Burst #	End Wave Burst # & Begin Wave Statistic Calculation #	End Wave Statistic Calculation #
12:00:00	#1	#1	-	-	-	-	-	-	-
12:15:00	#2	#2	#1	#1	-	-	-	-	-
12:15:02	-	-	-	-	#1	#1	#1	-	-
12:19:18	-	-	-	-	-	-	-	#1	-
12:19:49	-	-	-	-	-	-	-	-	#1
12:30:00	#3	#3	#2	#2	-	-	-	-	-
12:30:02	-	-	-	-	#2	-	-	-	-
12:45:00	#4	#4	#3	#3	-	-	-	-	-
12:45:02	-	-	-	-	#3	#2	#2	-	-
12:49:18	-	-	-	-	-	-	-	#2	-
12:49:49	-	-	-	-	-	-	-	-	#2
13:00:00	#5	#5	#4	#4	-	-	-	-	-

- If tide duration < (tide interval – 20 seconds), and wave burst duration + real-time wave statistics calculation < (tide interval – tide duration – 20 seconds):  
Wave burst sampling is done **after** the applicable tide measurement.  
For example, if the 26plus is set up to sample a wave burst every 2 tide measurements, the first wave burst starts 2 seconds after the second tide measurement is complete. See Quartz Example 2.

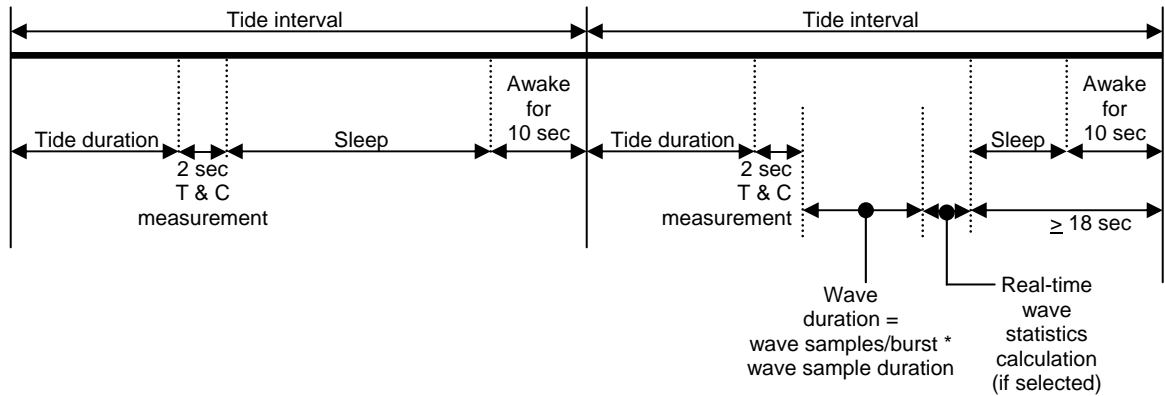

**Quartz Example 2:** Tide interval = 15 minutes = 900 sec; tide duration = 5 minutes = 300 sec.  
512 samples /wave burst at 0.25 sec/sample (512 x 0.25 = 128 sec) every 2 tide measurements.  
Calculate real-time wave statistics on 512 samples/wave burst (512 x 0.06 sec/calculation = 30.7 sec required at end of wave burst).  
Set **SetStartTime** to 12:00:00.  
Checking setup:  
tide duration = 300 sec < tide interval – 20 sec = 900 – 20 = 880 sec  
wave burst duration + real-time wave statistics = 128 + 30.7 = 159 sec < tide interval – tide duration - 20 sec = 900 – 300 - 20 = 580 sec

Time	Time Stamp for Tide #	Begin P for Tide #	End P for Tide #	Begin T & C for Tide #	End T & C for Tide #	Time Stamp for Wave Burst #	Begin Wave Burst #	End Wave Burst # & Begin Wave Statistic Calculation #	End Wave Statistic Calculation #
12:00:00	#1	#1	-	-	-	-	-	-	-
12:05:00	-	-	#1	#1	-	-	-	-	-
12:05:02	-	-	-	-	#1	-	-	-	-
12:15:00	#2	#2	-	-	-	-	-	-	-
12:20:00	-	-	#2	#2	-	-	-	-	-
12:20:02	-	-	-	-	#2	#1	#1	-	-
12:22:10	-	-	-	-	-	-	-	#1	-
12:22:41	-	-	-	-	-	-	-	-	#1
12:30:00	#3	#3	-	-	-	-	-	-	-
12:35:00	-	-	#3	#3	-	-	-	-	-
12:35:02	-	-	-	-	#3	-	-	-	-
12:45:00	#4	#4	-	-	-	-	-	-	-
12:50:00	-	-	#4	#4	-	-	-	-	-
12:50:02	-	-	-	-	#4	#2	#2	-	-
12:52:10	-	-	-	-	-	-	-	#2	-
12:52:41	-	-	-	-	-	-	-	-	#2

**Note:**

As shown, for this scheme the tide duration and T and C timing depend on whether a wave burst occurs during the tide interval. **Consequently, do not use this scheme if you want tide pressure and T and C data at regular intervals.**

- If tide duration < (tide interval – 20 seconds) and wave burst duration + real-time wave statistics calculation > (tide interval – tide duration – 20 seconds):  
Wave burst sampling is done **during** the applicable tide measurement, and for that tide the tide duration is set to the tide interval (26plus does not go to sleep for that tide). See Quartz Example 3.

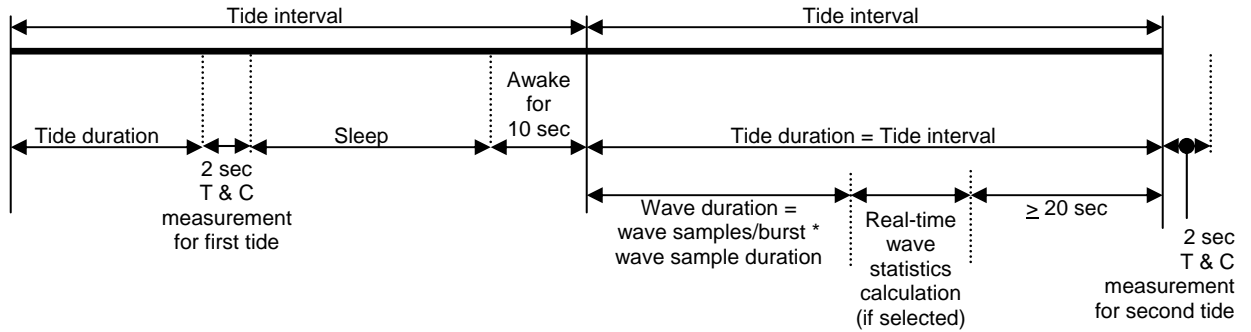

**Quartz Example 3:** Tide interval = 15 minutes = 900 sec; tide duration = 2 minutes = 120 sec.

Wave burst of 1024 samples at 0.75 sec/sample (1024 x 0.75 = 768 sec = 12 minutes, 48 seconds) every 2 tide measurements.

Calculate real-time wave statistics on 512 samples/wave burst (512 x 0.06 sec/calculation = 30.7 sec required at end of wave burst).

Set **SetStartTime** to 12:00:00.

Checking setup:

tide duration = 120 sec < tide interval – 20 sec = 900 – 20 = 880 sec

wave burst duration + real-time wave statistics = 768 + 30.7 = 799 sec > tide interval – tide duration - 20 sec = 900 – 120 - 20 = 760 sec

Time	Time Stamp for Tide #	Begin P for Tide #	End P for Tide #	Begin T & C for Tide #	End T & C for Tide #	Time Stamp for Wave Burst #	Begin Wave Burst #	End Wave Burst # & Begin Wave Statistic Calculation #	End Wave Statistic Calculation #
12:00:00	#1	#1	-	-	-	-	-	-	-
12:02:00	-	-	#1	#1	-	-	-	-	-
12:02:02	-	-	-	-	#1	-	-	-	-
12:15:00	#2	#2	-	-	-	#1	#1	-	-
12:27:48	-	-	-	-	-	-	-	#1	-
12:28:19	-	-	-	-	-	-	-	-	#1
12:30:00	#3	#3	#2	#2	-	-	-	-	-
12:30:02	-	-	-	-	#2	-	-	-	-
12:32:00	-	-	#3	#3	-	-	-	-	-
12:32:02	-	-	-	-	#3	-	-	-	-
12:45:00	#4	#4	-	-	-	#2	#2	-	-
12:47:48	-	-	-	-	-	-	-	#2	-
12:48:19	-	-	-	-	-	-	-	-	#2
13:00:00	#5	#5	#4	#4	-	-	-	-	-
13:00:02	-	-	-	-	#4	-	-	-	-

**Note for Quartz Example 3:**

Note the large variation in T & C timing and in the length of the tide pressure measurement using this scheme.

### Sample Timing with Strain Gauge Pressure Sensor

- If tide duration > (tide interval – 10 seconds), tide duration is set to (tide interval – 10). *26plus* goes to sleep between tide samples.

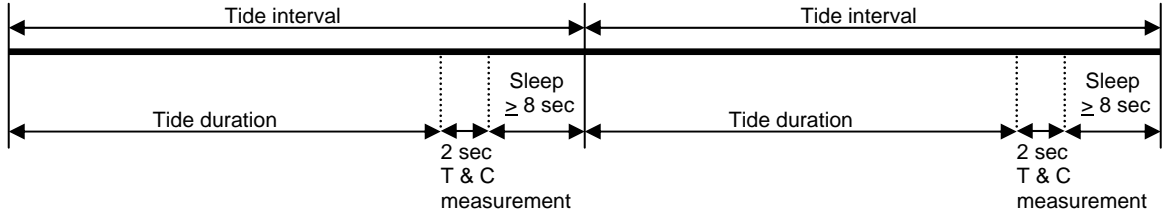

**Note:**  
 Sea-Bird recommends the following for meaningful wave statistics:

- Wave samples/burst  $\geq 512$ , and
- Wave samples/burst = power of 2 (512, 1024, etc.)

- If (wave burst duration + real-time wave statistics calculation) > (tide interval - 10 sec), the *26plus* increases the tide interval so that wave burst duration + real-time wave statistics calculation = (tide interval - 10 sec). Note that real-time wave statistics can be calculated on a subset of the total number of wave samples/burst; the real-time statistics calculation requires 0.06 sec/wave sample to be processed.

The drawing only shows the relationship between the maximum allowable wave burst duration, real-time statistics calculation, and tide interval; see other drawings below for sequencing of wave and tide measurements.

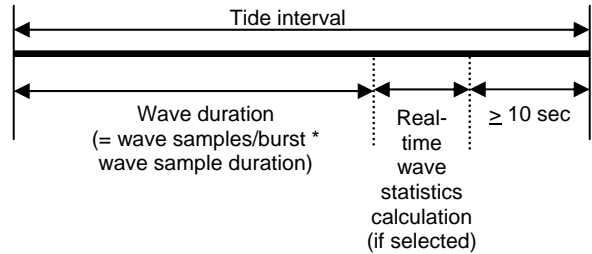

- If tide duration < (tide interval – 10 sec), and  
 (wave burst duration + real-time wave statistics calculation) <  
 (tide interval – tide duration – 10 sec):

Wave burst sampling is done **after** the applicable tide measurement.  
 For example, if the 26plus is set up to sample a wave burst every 2 tide measurements, the first wave burst starts 2 seconds after the second tide measurement. See Strain Gauge Example 1.

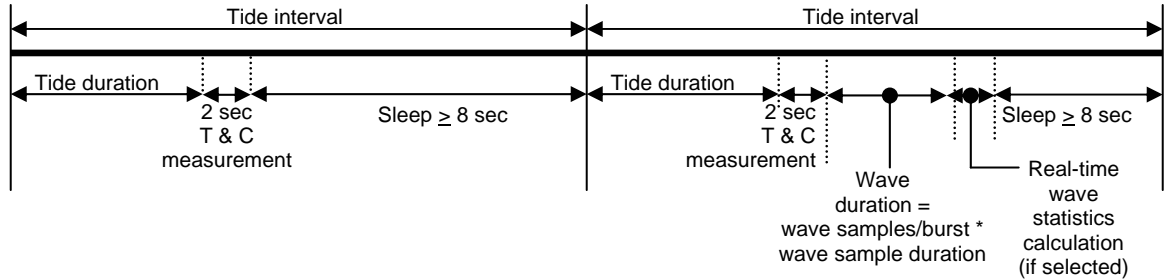

**Strain Gauge Example 1:** Tide interval = 15 minutes = 900 sec; tide duration = 5 minutes = 300 sec.  
 512 samples /wave burst at 0.25 sec/sample (512 x 0.25 = 128 sec) every 2 tide measurements.  
 Calculate real-time wave statistics on 512 samples/wave burst (512 x 0.06 sec/calculation = 30.7 sec required at end of wave burst).  
 Set **SetStartTime** to 12:00:00.

Checking setup:

tide duration = 300 sec < tide interval – 10 sec = 900 – 10 = 890 sec

wave burst duration + real-time wave statistics = 128 + 30.7 = 159 sec < tide interval – tide duration - 10 sec = 900 – 300 - 10 = 590 sec

Time	Time Stamp for Tide #	Begin P for Tide #	End P for Tide #	Begin T & C for Tide #	End T & C for Tide #	Time Stamp for Wave Burst #	Begin Wave Burst #	End Wave Burst # & Begin Wave Statistic Calculation #	End Wave Statistic Calculation #
12:00:00	#1	#1	-	-	-	-	-	-	-
12:05:00	-	-	#1	#1	-	-	-	-	-
12:05:02	-	-	-	-	#1	-	-	-	-
12:15:00	#2	#2	-	-	-	-	-	-	-
12:20:00	-	-	#2	#2	-	-	-	-	-
12:20:02	-	-	-	-	#2	#1	#1	-	-
12:22:10	-	-	-	-	-	-	-	#1	-
12:22:41	-	-	-	-	-	-	-	-	#1
12:30:00	#3	#3	-	-	-	-	-	-	-
12:35:00	-	-	#3	#3	-	-	-	-	-
12:35:02	-	-	-	-	#3	-	-	-	-
12:45:00	#4	#4	-	-	-	-	-	-	-
12:50:00	-	-	#4	#4	-	-	-	-	-
12:50:02	-	-	-	-	#4	#2	#2	-	-
12:52:10	-	-	-	-	-	-	-	#2	-
12:52:41	-	-	-	-	-	-	-	-	#2



**Note:**

As shown, for this scheme the tide duration and T and C timing depend on whether a wave burst occurs during the tide interval. **Consequently, do not use this scheme if you want tide pressure and T and C data at regular intervals.**

- If tide duration < (tide interval – 10 sec) and (wave burst duration + real-time wave statistics calculation) > (tide interval – tide duration – 10 sec):  
Wave burst sampling is done **instead of** the applicable tide measurement, and for that tide the data from the entire wave burst is averaged to calculate the tide measurement. See Strain Gauge Example 2.

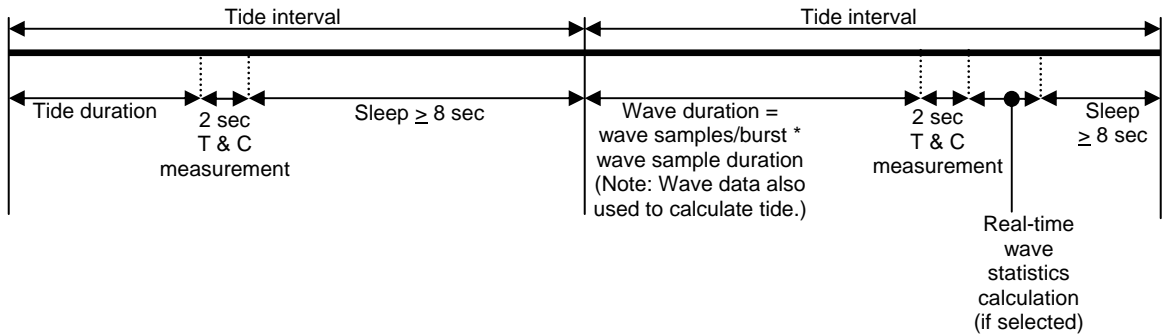

**Strain Gauge Example 2:** Tide interval = 15 minutes = 900 sec; tide duration 3 minutes = 180 sec.

Wave burst of 1024 samples at 0.75 sec/sample (1024 x 0.75 = 768 sec = 12 minutes, 48 seconds) every 2 tide measurements.

Calculate real-time wave statistics on 512 samples/wave burst (512 x 0.06 sec/calculation = 30.7 sec required at end of wave burst).

Set **SetStartTime** to 12:00:00.

Checking setup:

tide duration = 180 sec < tide interval – 10 sec = 900 – 10 = 890 sec

wave burst duration + real-time wave statistics = 768 + 30.7 = 799 sec > tide interval – tide duration - 10 sec = 900 – 180 - 10 = 710 sec

Time	Time Stamp for Tide #	Begin P for Tide #	End P for Tide #	Begin T & C for Tide #	End T & C for Tide #	Time Stamp for Wave Burst #	Begin Wave Burst #	End Wave Burst #	Begin Wave Calculation #	End Wave Calculation #
12:00:00	#1	#1	-	-	-	-	-	-	-	-
12:03:00	-	-	#1	#1	-	-	-	-	-	-
12:03:02	-	-	-	-	#1	-	-	-	-	-
12:15:00	#2	-	-	-	-	#1	#1	-	-	-
12:27:48	-	-	-	#2	-	-	-	#1	-	-
12:27:50	-	-	-	-	#2	-	-	-	#1	-
12:28:21	-	-	-	-	-	-	-	-	-	#1
12:30:00	#3	#3	-	-	-	-	-	-	-	-
12:33:00	-	-	#3	#3	-	-	-	-	-	-
12:33:02	-	-	-	-	#3	-	-	-	-	-
12:45:00	#4	-	-	-	-	#2	#2	-	-	-
12:57:48	-	-	-	#4	-	-	-	#2	-	-
12:57:50	-	-	-	-	#4	-	-	-	#2	-
12:58:21	-	-	-	-	-	-	-	-	-	#2
13:00:00	#5	#5	-	-	-	-	-	-	-	-

**Notes for Strain Gauge Example 2:**

- A separate tide measurement is not made during a tide interval that includes a wave burst; the value reported for that tide is the average of the measurements taken over the entire wave burst.
- Note the large variation in T & C timing and in the length of the tide pressure measurement using this scheme.

# Appendix III: Data Formats

This appendix provides detailed information on data format for each file type, except as noted.

Extension	Description
<b>.cap</b>	Capture file of real-time data from 26plus.
<b>.hex</b>	Hex data uploaded from 26plus memory using SeatermW. Also, Hex data from multiple logging sessions split into separate files by Extract Tide.
<b>.tid</b>	Tide measurements only, created from .hex file by Convert Hex. Also, file output by Merge Barometric Pressure, which removes barometric pressure from an input .tid file.
<b>.bp</b>	Barometric pressure data, used by Merge Barometric Pressure to remove barometric pressure from tide data (.tid) file. See <i>Section 7: Tide Data Processing – Merge Barometric Pressure</i> for .bp format.
<b>.wb</b>	Wave measurements only, created from .hex file by Convert Hex.
<b>.was</b>	Statistics and results from auto-spectrum analysis, created by Process Wave Burst Data.
<b>.rpt</b>	Summary report, created by Process Wave Burst Data.
<b>.wss</b>	Fast Fourier Transform coefficients, created by Process Wave Burst data if <i>Output FFT coefficients to .wss file</i> is selected. Details not provided.
<b>.wts</b>	Statistics from surface wave zero crossing analysis, created by Process Wave Burst Data.
<b>.wt</b>	Surface wave time series, created by Process Wave Burst Data if <i>Output surface wave time series to .wt file</i> is selected.
<b>.r26</b>	File containing one line of surface wave time series and/or wave burst auto-spectrum statistics for each processed wave burst, created by Create Reports.

## Real-Time Data Format (.cap extension)

Real-time data can be saved to a .cap file if you click Capture in SeatermW.

- Real-time tide data is output if **TxTide=Y**.
- Real-time wave data is output if **TxWave=Y**.
- Real-time wave statistics is output if you set **TXWAVESTATS=Y** in the **SetSampling** prompt.

### Note:

Each tide measurement record displays **after** the tide duration is complete. For example, if the tide duration is 10 minutes, the first tide data displays 10 minutes after logging starts.

Each time a **tide** measurement is completed, the display looks like this if the

**DS** response shows `transmit real-time tide data = YES`

(real-time tide data was enabled with **TxTide=Y**):

```
Tide: start time = 21 Nov 2004 13:40:01, p =14.2135,
pt = 21.952, t = 21.0250, c = 4.81952, s = 34.3799
```

where:

- start time = start of tide measurement
- p = calculated and stored pressure (psia)
- pt = calculated pressure temperature (not stored) (°C)
- t = calculated and stored temperature (°C)
- c = calculated and stored conductivity (S/m) and  
s = calculated salinity (not stored) (psu).

Note that c and s display only if **DS** response shows `conductivity = YES` (conductivity acquisition was enabled with **Conductivity=Y**).

Each time a **wave** measurement is made, the display looks like this if the **DS** response shows `transmit real-time wave burst data = YES` (real-time wave data transmission was enabled with **TxWave=Y**):

```

wave: start time = 21 Nov 2004 13:43:13
wave: ptfreq = 172046.343      or      wave: ptRaw = 1.278
14.5599
14.5598
14.5597
. . .
14.5598
wave: end wave burst

```

where:

- start time = start of wave measurement.
- ptfreq = pressure temperature frequency (Hz); displays only for *26plus* with Quartz pressure sensor.
- ptRaw = calculated pressure temperature number; displays only for *26plus* with Strain Gauge pressure sensor.
- Remaining displayed values are calculated and stored pressures (psia).

**Note:**

Sample output shown assumes you set `Show progress messages = n` in the **SetSampling** prompt.

Each time a **wave** burst is completed, the display looks like this if the **DS** response shows `transmit real-time wave statistics = YES` (real-time wave statistics was enabled with `TXWAVESTATS=Y` in the **SetSampling** command prompt):

```

Auto-Spectrum Statistics:
nAvgBand = 5
total variance = 1.7509e-08
total energy = 1.7137e-04
significant period = 4.2667e+01
significant wave height = 5.2928e-04

```

```

Time Series Statistics:
Wave integration time = 128
Number of waves = 0
Total variance = 1.6868e-08
Total energy = 1.6512e-04
Average wave height = 0.0000e+00
Average wave period = 0.0000e+00
Maximum wave height = 5.9477e-04
Significant wave height = 0.0000e+00
Significant wave period = 0.0000e+00
H1/10 = 0.0000e+00
H1/100 = 0.0000e+00

```

where:

- Auto-Spectrum Statistics -  
nAvgBand = user-input number of spectral estimates for each frequency band, and  
next 4 lines are calculated (not stored) auto-spectrum statistics
- Time Series Statistics -  
wave integration time (sec) = wave burst duration  
= user input number of samples / burst \* sample duration, and  
remaining lines are calculated (not stored) time series statistics

**Note:**

See *Appendix VI: Wave Theory and Statistics* for a description of calculation of wave statistics.

## Hex Data Format with Quartz Pressure Sensor (.hex extension)

A .hex file contains hexadecimal data uploaded from SBE 26plus memory using SeatermW's Upload.

The beginning of a sample .hex file for a 26plus with Quartz pressure sensor and without conductivity follows:

```
*Sea-Bird SBE 26plus Data File:
*FileName = C:\26plus\QuartzNoCond.hex
*Software Version 1.07
*DS
*SBE 26plus V 6.1c SN 1022 10 Dec 2006 10:43:20
*user info= test file
*quartz pressure sensor: serial number = 12345, range = 45 psia
*internal temperature sensor
*conductivity = NO
*iop = 5.9 ma vmain = 18.5 V vlith = 9.1 V
*last sample: p = 14.8637, t = 18.8973
*
*tide measurement: interval = 5.000 minutes, duration = 120 seconds
*measure waves every 3 tide samples
*512 wave samples/burst at 4.00 scans/sec, duration = 128 seconds
*logging start time = do not use start time
*logging stop time = do not use stop time
*
*tide samples/day = 288.000
*wave bursts/day = 96.000
*memory endurance = 218.6 days
*nominal alkaline battery endurance = 319.5 days
*total recorded tide measurements = 17
*total recorded wave bursts = 5
*tide measurements since last start = 17
*wave bursts since last start = 5
*
*transmit real-time tide data = NO
*transmit real-time wave burst data = NO
*transmit real-time wave statistics = NO
*
*status = stopped by user
*logging = NO, send start command to begin logging
*S>DC
*Pressure coefficients:
* U0 = 5.856409e+00
* . . . (more pressure sensor calibration coefficients)
* M = 279620.2
* B = 18641.3
* offset = 0.000000e+00
*Temperature coefficients:
* TA0 = 5.473956e-04
* TA1 = 1.803112e-04
* TA2 = 3.899926e-06
* TA3 = 6.722141e-09
*S>DD
FFFFFFFFFFFFFFFF (flag beginning of tide parameters)
091CB0510000000000 (time of beginning of first tide sample)
012C00010000000000 (tide sample interval, wave integration period)
FFFFFFFFFFFFFFFF (flag end of tide parameters)
3FB78A6CA4091CB051 (tide data – pressure, temperature, and time)
3FB7DE6CEB091CB17D (tide data – pressure, temperature, and time)
3FB8F66D33091CB2A9 (tide data – pressure, temperature, and time)
000000000000000000 (flag beginning of wave burst)
091CB3220200000000 (time of beginning of wave burst, number of samples in burst)
029B83E80000000000 (pressure temperature compensation number, number of samples in burst)
87CED887CED6 (wave burst pressure data)
. . . (wave burst pressure data)
87CEE087CEEA (wave burst pressure data)
FFFFFFFFFFFFFFFF (flag end of wave burst)
3FB8BE6D77091CB3D5 (tide data – pressure, temperature, and time)
3FB8DA6DBD091CB501 (tide data – pressure, temperature, and time)
3FB9826E01091CB62D (tide data – pressure, temperature, and time)
000000000000000000 (flag beginning of wave burst)
. . .
```

### Note:

If you uploaded data in binary, SeatermW sent **DBbaud,b,e** instead of **DD**. However, the uploaded .hex file *always* shows the **DD** command, so the file looks exactly the same, regardless of whether ASCII or binary upload was used.

The beginning of a sample .hex file for a 26plus with Quartz pressure sensor and with conductivity follows:

(beginning of file, with **DS** and **DC** response, same as shown above, except **DS** response shows *conductivity = YES*, the calculated memory endurance and battery endurance in **DS** response is reduced, and **DC** response shows conductivity coefficients in addition to pressure and temperature coefficients)

**Note:**

If you uploaded data in binary, SeatermW sent **DBbaud,b,e** instead of **DD**. However, the uploaded .hex file *always* shows the **DD** command, so the file looks exactly the same, regardless of whether ASCII or binary upload was used.

```
*S>DD
FFFFFFFFFFFFFFFFBFFFFFFFFF (flag beginning of tide parameters)
091B5BA70000000000000000 (time of beginning of first tide sample)
012C00010000000000000000 (tide sample interval, wave integration period)
FFFFFFFFFFFFFFFFCFFFFFFFFF (flag end of tide parameters)
3FF42973A00000000091B5BA7 (tide data – pressure, temperature, conductivity, and time)
3FF59573D60000000091B5CD3 (tide data – pressure, temperature, conductivity, and time)
3FF674740E0000000091B5DFE (tide data – pressure, temperature, conductivity, and time)
000000000000000000000000 (flag beginning of wave burst)
091B5E790200000000000000 (time of beginning of wave burst, number of samples in burst)
029B92F40000000000000000 (pressure temperature compensation number, number of samples in burst)
87CAA787CAA1 (wave burst pressure data)
. . . (wave burst pressure data)
87CA9387CAA1 (wave burst pressure data)
FFFFFFFFFFFFFFFFFFFFFFFF (flag end of wave burst)
3FF71C743F0000000091B5F2B (tide data – pressure, temperature, conductivity, and time)
3FF8F774720000000091B6057 (tide data – pressure, temperature, conductivity, and time)
3FF9BB74A60000000091B6183 (tide data – pressure, temperature, conductivity, and time)
000000000000000000000000 (flag beginning of wave burst)
. . .
```

- Beginning lines - \* flags header. Header lines contain (in order):
  - Input file name
  - Software version used to upload the data
  - 26plus response to status (**DS**) command
  - 26plus response to calibration coefficients (**DC**) command
- Following lines - Data follows, with each line followed by a carriage return and line feed. Data is described below.

### Setup Parameters and Tide Data – with Quartz Pressure

Data (lines after the \*S>DD) is described below:

Tide Line	26plus without Conductivity (all flags and tide data are 9 bytes = 18 Hex characters)	26plus with Conductivity (all flags and tide data are 12 bytes = 24 Hex characters)
1*	FFFFFFFFBFFFFFFFFF - Flag start of setup parameters.	FFFFFFFFFFFFFFFFFFFFFFFF - Flag start of setup parameters.
2*	091CB0510000000000 - First 5 bytes is start time (seconds since January 1, 2000) of integration of first tide sample. Remaining bytes are 0's.	091B5BA70000000000000000 - First 5 bytes is start time (seconds since January 1, 2000) of integration of first tide sample. Remaining bytes are 0's.
3*	012C00010000000000 - First 2 bytes (012C) is tide sample interval (seconds); next 2 bytes (0001) is number of 0.25-second periods to integrate wave samples. Remaining bytes are 0's	012C00010000000000000000 - First 2 bytes (012C) is tide sample interval (seconds); next 2 bytes (0001) is number of 0.25-second periods to integrate wave samples. Remaining bytes are 0's.
4*	FFFFFFFFFCFFFFFFFF - Flag end of setup parameters.	FFFFFFFFFFFFFFFFFCFFFFFFFF - Flag end of setup parameters.
5	3FB78A6CA4091CB051 - Tide record (pressure, temperature, and time). First 3 bytes (3FB78A) is pressure number, next 2 bytes (6CA4) is temperature number, and last 4 bytes (091CB051) is start time of tide measurement (seconds since January 1, 2000).	3FF42973A0000000091B5BA7 - Tide record (pressure, temperature, conductivity, and time). First 3 bytes (3FF429) is pressure number, next 2 bytes (73A0) is temperature number, next 3 bytes (000000) is conductivity number, and last 4 bytes (091B5BA7) is start time of tide measurement (seconds since January 1, 2000).
6	3FB7DE6CEB091CB17D - Tide record (pressure, temperature, and time). First 3 bytes (3FB7DE) is pressure number, next 2 bytes (6CEB) is temperature number, and last 4 bytes (091CB17D) is start time of tide measurement (seconds since January 1, 2000).	3FF59573D6000000091B5CD3 - Tide record (pressure, temperature, conductivity, and time). First 3 bytes (3FF595) is pressure number, next 2 bytes (73D6) is temperature number, next 3 bytes (000000) is conductivity number, and last 4 bytes (091B5CD3) is start time of tide measurement (seconds since January 1, 2000).
7	3FB8F66D33091CB2A9 - tide record (pressure, temperature, and time). First 3 bytes (3FB8F6) is pressure number, next 2 bytes (6D33) is temperature number, and last 4 bytes (091CB2A9) is start time of tide measurement (seconds since January 1, 2000).	3FF674740E000000091B5DFF - Tide record (pressure, temperature, conductivity, and time). First 3 bytes (3FF674) is pressure number, next 2 bytes (740E) is temperature number, next 3 bytes (000000) is conductivity number, and last 4 bytes (091B5DFF) is start time of tide measurement (seconds since January 1, 2000).
8	000000000000000000 - Flag beginning of wave burst. Setup for this example was to measure waves every 3 tide samples, so there are 3 tide records (lines 5 to 7) before wave burst flag.	000000000000000000000000 - Flag beginning of wave burst. Setup for this example was to measure waves every 3 tide samples, so there are 3 tide records (lines 5 to 7) before wave burst flag.

\* An uploaded file that includes multiple logging sessions contains these four records at the start of each logging session, to provide sampling parameters for that logging session.

**Note:**

You must run ExtractTide.exe before Convert Hex if your uploaded .hex file contains data from multiple logging sessions. See Section 6: Conversion into Tide and Wave Files – Extract Tide and Convert Hex.

Convert Hex converts the hex data to pressure, temperature, (optional) conductivity, and time in engineering units when the data is separated into tide and wave burst files. The tide data conversions are described below:

**pressure** (psia) = [ slope correction \* (pressure number - B) / M ] + offset correction  
where

- pressure number is the first 3 bytes (6 characters) of the tide data, converted from Hex to decimal.
- slope and offset corrections are read from the Convert Hex calibration coefficients (.psa) file. Note that the *pressure number* already includes the effect of the offset entered in the 26plus EEPROM with the **POffset=** command.
- M and B are scaling parameters that depend on pressure sensor range. They are calculated by the 26plus and are read by Convert Hex from the uploaded .hex file header (in the **DC** response).

**temperature** (°C) = (temperature number / 1000) - 10

where

- temperature number is the next 2 bytes (4 characters) of the tide data, converted from Hex to decimal.

**conductivity** frequency (Hz) = conductivity number / 256

where

- Conductivity number is the next 3 bytes (6 characters) of the tide data, converted from Hex to decimal.

Conductivity frequency is converted to conductivity using the coefficients and equation found on the calibration certificate for the sensor. These coefficients are entered in the 26plus EEPROM at the factory using the calibration coefficient commands, and are read by Convert Hex from the uploaded .hex file header (in the **DC** response).

**time** = time number = number of seconds since January 1, 2000

- Time is the last 4 bytes (8 characters) of the tide data, converted from Hex to decimal.

*Example 1 (no conductivity, from sample file above):*

tide record = 3FB78A6CA4091CB051 hex

The first 3 bytes are 3FB78A hex = 4175754 decimal.

For this example, M = 279620.2 and B = 18641.3 (in **DC** response in .hex file)

Assume slope correction = 1.0 and offset correction = 0 in the .psa file.

pressure = [ slope correction \* (pressure number - B) / M ] + offset correction

pressure = [ 1.0 \* (4175754 - 18641.3) / 279620.2 ] + 0 = 14.8670 psia

The next 2 bytes are 6CA4 hex = 27812 decimal.

temperature = (temperature number / 1000) - 10 = (27812 / 1000) - 10 = 17.812 °C

The last 4 bytes are 091CB051 hex = 152875089 decimal

Time = 152875089 seconds since Jan. 1, 2000 = November 4, 2004, 09:18:09

*Example 2 (conductivity enabled, from sample file above):*

tide record = 3FF42973A000000091B5BA7 hex

The first 3 bytes are 3FF429 hex = 4191273 decimal.

For this example, M = 279620.2 and B = 18641.3 (in **DC** response in .hex file)

Assume slope correction = 1.0 and offset correction = 0 in the .psa file.

pressure = [ slope correction \* (pressure number - B) / M ] + offset correction

pressure = [ 1.0 \* (4191273 - 18641.3) / 279620.2 ] + 0 = 14.9225 psia

The next 2 bytes are 73A0 hex = 29600 decimal.

temperature = (temperature number / 1000) - 10 = (29600 / 1000) - 10 = 19.6 °C

The next 3 bytes are 000000 hex = 0 decimal.

conductivity frequency (Hz) = conductivity number / 256

conductivity frequency (Hz) = 0 / 256 = 0 Hz

The last 4 bytes are 091B5BA7 hex = 152787879 decimal

Time = 152787879 seconds since Jan. 1, 2000 = November 3, 2004, 09:04:39

### Wave Burst Data – with Quartz Pressure

Data (lines from beginning to end of wave burst) is described below:

Wave Burst Line	<b>26plus without Conductivity</b> (all wave pressure data is 6 bytes = 12 Hex characters; all flags and other wave data is 9 bytes = 18 Hex characters)	<b>26plus with Conductivity</b> (all wave pressure data is 6 bytes = 12 Hex characters; all flags and other wave data is 12 bytes = 24 Hex characters)
1	000000000000000000 - Flag beginning of wave burst.	000000000000000000000000 - Flag beginning of wave burst.
2	091CB3220200000000 - First 4 bytes (091CB322) is start time (seconds since January 1, 2000) of wave burst. Next byte (02) is MSB of number of samples in wave burst. Remaining bytes are 0's.	091B5E790200000000000000 - First 4 bytes (091B5E79) is start time (seconds since January 1, 2000) of wave burst. Next byte (02) is MSB of number of samples in wave burst. Remaining bytes are 0's.
3	029B83E8000000000000 - First 4 bytes (029B83E8) is pressure temperature compensation number. Next byte (00) is LSB of number of samples in wave burst. (For example shown, number of samples in wave burst = 0200 Hex = 512 decimal). Remaining bytes are 0's.	029B92F40000000000000000 - First 4 bytes (029B92F4) is pressure temperature compensation number. Next byte (00) is LSB of number of samples in wave burst. (For example shown, number of samples in wave burst = 0200 Hex = 512 decimal). Remaining bytes are 0's.
4 and following	87CED887CED6 - First 3 bytes (87CED8) is pressure number for first wave measurement, last 3 bytes (87CED6) is pressure number for second wave measurement. Each subsequent line also contains data for 2 wave measurements. There are a total of [(wave samples/burst) / 2] lines of wave pressure data.	87CAA787CAA1 - First 3 bytes (87CAA7) is pressure number for first wave measurement, last 3 bytes (87CAA1) is pressure number for second wave measurement. Each subsequent line also contains data for 2 wave measurements. There are a total of [(wave samples/burst) / 2] lines of wave pressure data.
Last	FFFFFFFFFFFFFFFFFFFF - Flag end of wave burst.	FFFFFFFFFFFFFFFFFFFFFFFF - Flag end of wave burst.

**Note:**

You must run ExtractTide.exe before Convert Hex if your uploaded .hex file contains data from multiple logging sessions. See Section 6: Conversion into Tide and Wave Files – Extract Tide and Convert Hex.

Convert Hex converts the hex data to pressure in engineering units when the data is separated into tide and wave burst files. The wave burst data conversions are described below:

$$\text{Pressure temperature compensation frequency (Hz)} = \text{PTCF} \\ = \text{pressure temperature compensation number} / 256$$

$$\text{Pressure frequency (Hz)} = \text{PF} = \text{pressure number} / 256$$

Pressure is computed as follows:

$$U = [ (1.0 / \text{PTCF}) * 1000000 ] - U0$$

$$C = C1 + (C2 * U) + (C3 * U^2)$$

$$D = D1 + D2 \quad \text{but } D2 = 0, \text{ so } D = D1$$

$$T0 = (T1 + T2 * U + T3 * U^2 + T4 * U^3) / 1,000,000$$

$$W = 1.0 - (T0 * T0 * \text{PF} * \text{PF})$$

**pressure (psia)**

$$= \text{slope correction} * \{ [C * W * (1.0 - D * W)] + \text{POffset} \} + \text{offset correction}$$

where

- U0, C1, C2, C3, D1, T1, T2, T3, T4, and POffset are entered in the 26plus EEPROM at the factory using the calibration coefficient commands, and are read by Convert Hex from the uploaded .hex file header (in the DC command response).
- Slope and offset corrections are read from the Convert Hex calibration coefficients (.psa) file.



*Example (26plus with no conductivity, from sample file above):*

```

00000000000000000000 (flag beginning of wave burst)
091CB3220200000000 (time of beginning of wave burst, number of samples in burst)
029B83E80000000000 (pressure temperature compensation number, number of samples in burst)
87CED887CED6 (wave burst pressure data)
. . . (wave burst pressure data)
87CEE087CEEA (wave burst pressure data)
FFFFFFFFFFFFFFFFFFFF (flag end of wave burst)

```

pressure temperature compensation & number of samples = 029B83E80000000000 hex

Pressure temperature compensation number = 029B83E8 hex = 43746280 decimal

Pressure number for first wave burst pressure data (first 3 bytes)

= 87CED8 hex = 8900312 decimal

Pressure temperature compensation frequency = PTCF

= pressure temperature compensation number / 256 = 43746280 / 256 = 170883.90 Hz

Pressure frequency = PF = pressure number / 256 = 8900312 / 256 = 34766.843 Hz

Using calibration coefficients from uploaded hex file:

```

U0 = 5.856409e+00, Y1 = -3.987838e+03, Y2 = -1.049603e+04,
Y3 = 0.000000e+00, C1 = 2.305367e+02, C2 = 1.198422e+01,
C3 = -2.401512e+02, D1 = 4.095400e-02, D2 = 0.000000e+00,
T1 = 2.781994e+01, T2 = 6.760780e-01, T3 = 1.761829e+01,
T4 = 6.000932e+00, POffset = 0

```

$U = [(1.0 / \text{PTCF}) * 1,000,000] - U0$

=  $[(1.0 / 170883.90) * 1,000,000] - 5.856409e+00 = -0.004482634$

$C = C1 + (C2 * U) + (C3 * U^2)$

=  $2.305367e+02 + (1.198422e+01 * U) + (-2.401512e+02 * U^2)$

=  $2.305367e+02 - 0.05372087 - 0.004825600 = 2.304782e+02$

$D = D1 + D2 = 4.095400e-02 + 0 = 4.095400e-02$

$T0 = (T1 + T2 * U + T3 * U^2 + T4 * U^3) / 1,000,000$

=  $(2.781994e+01 + 6.760780e-01 * U + 1.761829e+01 * U^2$

+  $6.000932e+00 * U^3) / 1000000$

=  $(2.781994e+01 - 3.030610e-03 + 3.540221e-04 - 5.405284e-07) / 1,000,000$

=  $2.7817266e-05$

$W = 1.0 - (T0 * T0 * PF * PF)$

=  $1.0 - (2.7817266e-05 * 2.7817266e-05 * 34766.843 * 34766.843) = 6.468177e-02$

pressure = slope correction \*  $\{[C * W * (1.0 - D * W)] + \text{POffset}\} + \text{offset correction}$

For this example, assume slope correction = 1.0, and offset correction = 0.

pressure =  $(2.304782e+02) * (6.468177e-02) * (1.0 - [4.095400e-02 * 6.468177e-02])$

= 14.868 psia

## Hex Data Format with *Strain Gauge Pressure Sensor* (.hex extension)

A .hex file contains hexadecimal data uploaded from SBE 26plus memory using SeatermW's Upload.

The beginning of a sample .hex file for a 26plus with **Strain Gauge pressure sensor and without conductivity** follows:

```
*Sea-Bird SBE 26plus Data File:
*FileName = C:\sbe26plus\StrainGaugeNoCond.hex
*Software Version 1.07
*DS
*SBE 26plus V 6.1c SN 1034 10 Dec 2006 12:10:53
*user info= test file
*strain gauge pressure sensor: serial number = 5471, range = 45 psia
*internal temperature sensor
*conductivity = NO
*iop = 7.8 ma vmain = 18.4 V vlith = 9.1 V
*last sample: p = 14.9320, t = 21.5951
*
*tide measurement: interval = 5.000 minutes, duration = 120 seconds
*measure waves every 3 tide samples
*512 wave samples/burst at 4.00 scans/sec, duration = 128 seconds
*logging start time = do not use start time
*logging stop time = do not use stop time
*
*tide samples/day = 288.000
*wave bursts/day = 96.000
*memory endurance = 218.6 days
*nominal alkaline battery endurance = 94.9 days
*total recorded tide measurements = 36
*total recorded wave bursts = 12
*tide measurements since last start = 36
*wave bursts since last start = 12
*
*transmit real-time tide data = NO
*transmit real-time wave burst data = NO
*transmit real-time wave statistics = NO
*
*status = stopped by user
*logging = NO, send start command to begin logging
*S>DC
*Pressure coefficients: 05-feb-04
* PA0 = -7.912454e-02
* . . . (more pressure sensor calibration coefficients)
* OFFSET = 0.00
*Temperature coefficients: 05-jan-04
* TA0 = 2.993769e-04
* TA1 = 2.397817e-04
* TA2 = -8.392026e-07
* TA3 = 1.319386e-07
*S>DD
FFFFFFFFFFFFFFFF (flag beginning of tide parameters)
091B5D370000000000 (time of beginning of first tide sample)
012C00010000000000 (tide sample interval, wave integration period)
FFFFFFFFFFFFFFFF (flag end of tide parameters)
3FC29478FB091B5D37 (tide data - pressure, temperature, and time)
3FC3AE7940091B5E63 (tide data - pressure, temperature, and time)
3FC4F77981091B5F8F (tide data - pressure, temperature, and time)
000000000000000000 (flag beginning of wave burst)
091B60080200000000 (time of beginning of wave burst, number of samples in burst)
000005000000000000 (pressure temperature compensation number, number of samples in burst)
18FD5B18FD64 (wave burst pressure data)
. . . (wave burst pressure data)
18FDCF18FDD5 (wave burst pressure data)
FFFFFFFFFFFFFFFF (flag end of wave burst)
3FC56079C0091B60BB (tide data - pressure, temperature, and time)
3FC1017A47091B61E7 (tide data - pressure, temperature, and time)
3FC1097AC9091B6313 (tide data - pressure, temperature, and time)
000000000000000000 (flag beginning of wave burst)
. . .
```

### Note:

If you uploaded data in binary, SeatermW sent **DBbaud,b,e** instead of **DD**. However, the uploaded .hex file **always** shows the **DD** command, so the file looks exactly the same, regardless of whether ASCII or binary upload was used.

The beginning of a sample .hex file for a 26plus with Strain Gauge pressure sensor and with conductivity follows:

(beginning of file, with **DS** and **DC** response, same as shown above, except **DS** response shows *conductivity = YES*, the calculated memory endurance and battery endurance in **DS** response is reduced, and **DC** response shows conductivity coefficients in addition to pressure and temperature coefficients)

**Note:**

If you uploaded data in binary, SeatermW sent **DBbaud,b,e** instead of **DD**. However, the uploaded .hex file *always* shows the **DD** command, so the file looks exactly the same, regardless of whether ASCII or binary upload was used.

```
*S>DD
FFFFFFFFFFFFFFFFBFFFFFFFFF (flag beginning of tide parameters)
091CAFE700000000000000000 (time of beginning of first tide sample)
012C00010000000000000000 (tide sample interval, wave integration period)
FFFFFFFFFFFFFFFFCFFFFFFFFF (flag end of tide parameters)
3F9A816E500000000091CAFE7 (tide data – pressure, temperature, conductivity, and time)
3F9BF36EC1000000091CB113 (tide data – pressure, temperature, conductivity, and time)
3F9D136F47000000091CB23F (tide data – pressure, temperature, conductivity, and time)
000000000000000000000000 (flag beginning of wave burst)
091CB2BA0200000000000000 (time of beginning of wave burst, number of samples in burst)
000004DC0000000000000000 (pressure temperature compensation number, number of samples in burst)
18F03D18F054 (wave burst pressure data)
. . . (wave burst pressure data)
18F07518F063 (wave burst pressure data)
FFFFFFFFFFFFFFFFBFFFFFFFFF (flag end of wave burst)
3F9DA26FB4000000091CB36B (tide data – pressure, temperature, conductivity, and time)
3F9DBE7010000000091CB497 (tide data – pressure, temperature, conductivity, and time)
3F9F1A706A000000091CB5C3 (tide data – pressure, temperature, conductivity, and time)
000000000000000000000000 (flag beginning of wave burst)
. . .
```

- Beginning lines - \* flags header. Header lines contain (in order):
  - Input file name
  - Software version used to upload the data
  - 26plus response to status (**DS**) command
  - 26plus response to calibration coefficients (**DC**) command
- Following lines - Data follows, with each line followed by a carriage return and line feed. Data is described below.

### Setup Parameters and Tide Data – with *Strain Gauge Pressure*

Data (lines after the \*S>DD) is described below:

<b>Tide Line</b>	<b>26plus without Conductivity</b> (all flags and tide data is 9 bytes = 18 Hex characters)	<b>26plus with Conductivity</b> (all flags and tide data is 12 bytes = 24 Hex characters)
1*	FFFFFFFFBFFFFFFFFF - Flag start of setup parameters.	FFFFFFFFFFFFFFFFFFFFFFFF - Flag start of setup parameters.
2*	091B5D370000000000 - First 5 bytes is start time (seconds since January 1, 2000) of integration of first tide sample. Remaining bytes are 0's.	091CAFE700000000000000000 - First 5 bytes is start time (seconds since January 1, 2000) of integration of first tide sample. Remaining bytes are 0's.
3*	012C0001000000000000 - First 2 bytes (012C) is tide sample interval (seconds); next 2 bytes (0001) is number of 0.25-second periods to integrate wave samples. Remaining bytes are 0's.	012C0001000000000000000000 - First 2 bytes (012C) is tide sample interval (seconds); next 2 bytes (0001) is number of 0.25-second periods to integrate wave samples. Remaining bytes are 0's.
4*	FFFFFFFFFCFFFFFFFF - Flag end of setup parameters.	FFFFFFFFFFFFFFFFFCFFFFFFFF - Flag end of setup parameters.
5	3FC29478FB091B5D37 - Tide record (pressure, temperature, and time). First 3 bytes (3FC294) is pressure number, next 2 bytes (78FB) is temperature number, and last 4 bytes (091B5D37) is start time of tide measurement (seconds since January 1, 2000).	3F9A816E50000000091CAFE7 - Tide record (pressure, temperature, conductivity, and time). First 3 bytes (3F9A81) is pressure number, next 2 bytes (6E50) is temperature number, next 3 bytes (000000) is conductivity number, and last 4 bytes (091CAFE7) is start time of tide measurement (seconds since January 1, 2000).
6	3FC3AE7940091B5E63 - Tide record (pressure, temperature, and time). First 3 bytes (3FC3AE) is pressure number, next 2 bytes (7940) is temperature number, and last 4 bytes (091B5E63) is start time of tide measurement (seconds since January 1, 2000).	3F9BF36EC1000000091CB113 - Tide record (pressure, temperature, conductivity, and time). First 3 bytes (3F9BF3) is pressure number, next 2 bytes (6EC1) is temperature number, next 3 bytes (000000) is conductivity number, and last 4 bytes (091CB113) is start time of tide measurement (seconds since January 1, 2000).
7	3FC4F77981091B5F8F - Tide record (pressure, temperature, and time). First 3 bytes (3FC4F7) is pressure number, next 2 bytes (7981) is temperature number, and last 4 bytes (091B5F8F) is start time of tide measurement (seconds since January 1, 2000).	3F9D136F47000000091CB23F - Tide record (pressure, temperature, conductivity, and time). First 3 bytes (3F9D13) is pressure number, next 2 bytes (6F47) is temperature number, next 3 bytes (000000) is conductivity number, and last 4 bytes (091CB23F) is start time of tide measurement (seconds since January 1, 2000).
8	00000000000000000000 - Flag beginning of wave burst. Setup for this example was to measure waves every 3 tide samples, so there are 3 tide records (lines 5 to 7) before wave burst flag.	000000000000000000000000 - Flag beginning of wave burst. Setup for this example was to measure waves every 3 tide samples, so there are 3 tide records (lines 5 to 7) before wave burst flag.

\* An uploaded file that includes multiple logging sessions contains these four records at the start of each logging session, to provide the sampling parameters for that logging session.

**Note:**

You must run ExtractTide.exe before Convert Hex if your uploaded .hex file contains data from multiple logging sessions. See Section 6: Conversion into Tide and Wave Files – Extract Tide and Convert Hex.

Convert Hex converts the hex data to pressure, temperature, (optional) conductivity, and time in engineering units when the data is separated into tide and wave burst files. The tide data conversions are described below:

**pressure** (psia) = [ slope correction \* (pressure number - B) / M ] + offset correction  
where

- pressure number is the first 3 bytes (6 characters) of the tide data, converted from Hex to decimal.
- slope and offset corrections are read from the Convert Hex calibration coefficients (.psa) file. Note that the *pressure number* already includes the effect of the offset entered in the 26plus EEPROM with the **POffset=** command.
- M and B are scaling parameters that depend on pressure sensor range. They are calculated by the 26plus and are read by Convert Hex from the uploaded .hex file header (in the **DC** response).

**temperature** (°C) = (temperature number / 1000) - 10

where

- temperature number is the next 2 bytes (4 characters) of the tide data, converted from Hex to decimal.

**conductivity** frequency (Hz) = conductivity number / 256

where

- Conductivity number is the next 3 bytes (6 characters) of the tide data, converted from Hex to decimal.

Conductivity frequency is converted to conductivity using the coefficients and equation found on the calibration certificate for the sensor. These coefficients are entered in the 26plus EEPROM at the factory using the calibration coefficient commands, and are read by Convert Hex from the uploaded .hex file header (in the **DC** response).

**time** = time number = number of seconds since January 1, 2000

- Time is the last 4 bytes (8 characters) of the tide data, converted from Hex to decimal.

*Example 1 (no conductivity, from sample file above):* tide record = 3FC29478FB091B5D37 hex

The first 3 bytes are 3FC294 hex = 4178580 decimal.

For this example, M = 279620.2 and B = 18641.3 (in **DC** response in .hex file).

Assume slope correction = 1.0 and offset correction = 0 in .psa file.

pressure = [ slope correction \* (pressure number - B) / M ] + offset correction

pressure = [ 1.0 \* (4178580 - 18641.3) / 279620.2 ] + 0 = 14.8771 psia

The next 2 bytes are 78FB hex = 30971 decimal.

temperature = (temperature number / 1000) - 10 = (30971 / 1000) - 10 = 20.971 °C

The last 4 bytes are 091B5D37 hex = 152788279 decimal

Time = 152788279 seconds since January 1, 2000 = November 3, 2004, 09:11:19

*Example 2 (conductivity enabled, from sample file above):*

tide record = 3F9A816E50000000091CAFE7 hex

The first 3 bytes are 3F9A81 hex = 4168321 decimal.

For this example, M = 279620.2 and B = 18641.3 (in **DC** response in .hex file)

Assume slope correction = 1.0 and offset correction = 0 in .psa file.

pressure = [ slope correction \* (pressure number - B) / M ] + offset correction

pressure = [ 1.0 \* (4168321 - 18641.3) / 279620.2 ] + 0 = 14.8404 psia

The next 2 bytes are 6E50 hex = 28240 decimal.

temperature = (temperature number / 1000) - 10 = (28240 / 1000) - 10 = 18.24 °C

The next 3 bytes are 000000 hex = 0 decimal.

conductivity frequency (Hz) = conductivity number / 256

conductivity frequency (Hz) = 0 / 256 = 0 Hz

The last 4 bytes are 091CAFE7 hex = 152874983 decimal

Time = 152874983 seconds since January 1, 2000 = November 4, 2004, 09:16:23

### Wave Burst Data – with Strain Gauge Pressure

Data (lines from beginning to end of wave burst) is described below:

Wave Burst Line	26plus without Conductivity (all wave pressure data is 6 bytes = 12 Hex characters; all flags and other wave data is 9 bytes = 18 Hex characters)	26plus with Conductivity (all wave pressure data is 6 bytes = 12 Hex characters; all flags and other wave data is 12 bytes = 24 Hex characters)
1	000000000000000000 - Flag beginning of wave burst.	0000000000000000000000 - Flag beginning of wave burst.
2	091B60080200000000 - First 4 bytes (091B6008) is start time (seconds since January 1, 2000) of wave burst. Next byte (02) is MSB of number of samples in wave burst. Remaining bytes are 0's.	091CB2BA0200000000000000 - First 4 bytes (091CB2BA) is start time (seconds since January 1, 2000) of wave burst. Next byte (02) is MSB of number of samples in wave burst. Remaining bytes are 0's.
3	00000500000000000000 - First 4 bytes (00000500) is pressure temperature compensation number. Next byte (00) is LSB of number of samples in wave burst (for example shown, number of samples in wave burst = 0200 Hex = 512 decimal). Remaining bytes are 0's.	000004DC000000000000000000 - First 4 bytes (000004DC) is pressure temperature compensation number. Next byte (00) is LSB of number of samples in wave burst (for example shown, number of samples in wave burst = 0200 Hex = 512 decimal). Remaining bytes are 0's.
4 and following	18FD5B18FD64 - First 3 bytes (18FD5B) is pressure number for first wave measurement, last 3 bytes (18FD64) is pressure number for second wave measurement. Each subsequent line also contains data for 2 wave measurements. There are a total of [(wave samples/burst) / 2] lines of wave pressure data.	18F03D18F054 - First 3 bytes (18F03D) is pressure number for first wave measurement, last 3 bytes (18F054) is pressure number for second wave measurement. Each subsequent line also contains data for 2 wave measurements. There are a total of [(wave samples/burst) / 2] lines of wave pressure data.
Last	FFFFFFFFFFFFFFFFFFFF - Flag end of wave burst.	FFFFFFFFFFFFFFFFFFFFFFFFFFFF - Flag end of wave burst.

**Note:**

You must run ExtractTide.exe before Convert Hex if your uploaded .hex file contains data from multiple logging sessions. See Section 6: Conversion into Tide and Wave Files – Extract Tide and Convert Hex.

Convert Hex converts the hex data to pressure in engineering units when the data is separated into tide and wave burst files. The wave burst data conversions are described below:

**Pressure temperature compensation = PTC**

= pressure temperature compensation number / 1000

**Pressure = P** = pressure number / 8

**Pressure temperature = T =**

$PTempA0 + (PTempA1 * PTC) + (PTempA2 * PTC^2)$

$X = P - PTCA0 - (PTCA1 * T) - (PTCA2 * T^2)$

$N = X * PTCB0 / [PTCB0 + (PTCB1 * T) + (PTCB2 * T^2)]$

**pressure (psia)**

= slope correction \* [PA0 + (PA1\*N) + (PA2\*N<sup>2</sup>) + POffset] + offset correction  
where

- PA0, PA1, PA2, PTCA0, PTCA1, PTCA2, PTCB0, PTCB1, PTCB2, PTempA0, PTempA1, PTempA2, and POffset are entered in the 26plus EEPROM at the factory using the calibration coefficient commands, and are read by Convert Hex from the uploaded .hex file header (in the DC command response).
- Slope and offset corrections are read from the Convert Hex calibration coefficients (.psa) file.

*Example (no conductivity, from sample file above):*

000000000000000000	(flag beginning of wave burst)
091B60080200000000	(time of beginning of wave burst, number of samples in burst)
000005000000000000	(pressure temperature compensation number, number of samples in burst)
18FD5B18FD64	(wave burst pressure data)
. . .	(wave burst pressure data)
18FDCF18FDD5	(wave burst pressure data)
FFFFFFFFFFFFFFFFFFFF	(flag end of wave burst)

Pressure temperature compensation & number of samples = 0000050000000000 hex

Pressure temperature compensation = 00000500 hex = 1280 decimal

**Pressure temperature compensation** = PTC = pressure temperature compensation number / 1000 =  
1280 / 1000 = 1.28

Pressure number for first wave burst pressure data (first 3 bytes) = 18FD5B hex = 1637723 decimal

**Pressure** = P = pressure number / 8 = 1637723 / 8 = 204715.375

Using calibration coefficients from uploaded hex file:

PA0 = -7.912454e-02, PA1 = 7.317688e-05, PA2 = -1.012808e-12,  
PTCA0 = 3.446204e+02, PTCA1 = -4.617518e+01, PTCA2 = -1.236197e-01,  
PTCB0 = 2.488438e+01, PTCB1 = 2.275000e-03, PTCB2 = 0.000000e+00,  
PTempA0 = -8.059255e+01, PTempA1 = 8.183057e+01, PTempA2 = -1.878352e+00, POffset = 0

**Pressure temperature** = T = PTempA0 + (PTempA1 \* PTC) + (PTempA2 \* PTC<sup>2</sup>) =  
-8.059255e+01 + (8.183057e+01 \* 1.28) + (-1.878352 \* 1.28<sup>2</sup>) = -80.59255 + 104.7431296 - 3.0774919168 =  
21.073

**X** = P - PTCA0 - (PTCA1 \* T) - (PTCA2 \* T<sup>2</sup>) =  
204715.375 - 3.446204e+02 - (-4.617518e+01 \* 21.073) - (-1.236197e-01 \* 21.073<sup>2</sup>) = 205398.704

**N** = X \* PTCB0 / [PTCB0 + (PTCB1 \* T) + (PTCB2 \* T<sup>2</sup>)] =  
205398.704 \* 2.488438e+01 / [2.488438e+01 + (2.275000e-03 \* 21.073) + (0 \* 21.073<sup>2</sup>)] = 205003.753

pressure = slope correction \* [ PA0 + (PA1 \* N) + (PA2 \* N<sup>2</sup>) + POffset ] + offset correction

For this example, assume slope correction = 1.0, and offset correction = 0.

pressure = (-7.912454e-02) + (7.317688e-05 \* 205003.753) + (-1.012808e-12 \* 205003.753<sup>2</sup>) = 14.880 psia

## Tide Data Format (.tid extension)

A .tid file is created from the .hex file in Convert Hex. A sample tide data (.tid) file is shown below:

1	11/13/92 10:27:16	14.8125	22.102	3.55682	23.909
2	11/13/92 10:28:16	15.0086	14.818	3.48032	27.844
3	11/13/92 10:29:16	15.0836	11.242	3.07901	26.714
4	11/13/92 10:30:16	15.1536	8.951	3.07101	28.376
5	11/13/92 10:31:16	15.2267	7.225	3.06788	29.772

**Note:**

If conductivity logging is not enabled (**Conductivity=N**; status display shows conductivity = NO), the sixth and seventh columns are not included in the .tid file.

- Column 1 = Tide measurement number
- Columns 2 and 3 = Date and time of beginning of tide measurement
- Column 4 = Measured pressure in psia
- Column 5 = Measured water temperature in °C
- Column 6 = Measured conductivity in S/m
- Column 7 = Calculated salinity in PSU

If Merge Barometric Pressure has been run on the .tid file to remove the effect of barometric pressure, the output .tid file contains descriptive column headings. The presence of headings in the .tid file indicates that it has been processed by Merge Barometric Pressure. Additionally, Merge Barometric Pressure has the ability to replace the pressure in the fourth column with calculated water depth. See *Section 7: Tide Data Processing – Merge Barometric Pressure* for details, and for the required data format for the barometric pressure (.bp) file to input in Merge Barometric Pressure.

## Wave Burst Data Format (.wb extension)

A .wb file is created from the .hex file in Convert Hex. A sample wave burst data file is shown below:

**Note:**

This wave data was obtained while the instrument was on land, so the output is indicating essentially 0 wave height.

```
SBE 26plus
* 0 152875706 0.25 512
    14.842843 14.843052 14.842925 14.842970
    14.842998 14.843070 14.843125 14.843025
    14.843079 14.842952 14.842998 14.842970
. . . . (remaining data for first wave burst)
* 1 152876606 0.25 512
    14.844642 14.844933 14.844914 14.844851
    14.844942 14.844914 14.844969 14.844787
    14.844833 14.844887 14.844860 14.844887
. . . . (remaining data for second wave burst)
```

- First line - \* flags beginning of data for a wave burst. Line contains (in order):
  - Wave burst number
  - Start of wave burst measurement (seconds since January 1, 2000)
  - Wave integration period (seconds)
  - Number of points in wave burst
- Second and following lines (until next line with \*) - Measured pressures in psia, with four values per line



## Wave Burst Auto-Spectrum Statistics (.was extension)

A .was file is created from the .wb file in Process Wave Burst Data. A sample wave burst Auto-Spectrum statistics file is shown below:

```
SBE 26plus
* 0 39714178 1.00 1024 10 5.666 4.466 1024.211 90 0.637 1.843
51 5.371094e-003 9.765625e-003 5.9946e-003 6.0210e+001 1.0732e+001 3.0970e-001
3.091334e-003 3.298001e-003 2.160857e-003 7.776975e-004
5.304750e-003 3.731420e-003 1.790720e-002 2.439886e-002
8.326155e-002 1.082657e-001 5.056803e-002 5.299359e-002
2.502890e-002 2.332787e-002 2.122386e-002 1.846813e-002
3.559706e-002 3.633030e-002 2.943071e-002 8.796323e-003
8.000838e-003 4.111465e-003 2.995502e-003 6.887020e-003
2.995481e-003 4.263404e-003 1.317504e-003 3.054346e-003
1.688730e-003 2.141096e-003 1.688405e-003 3.960159e-003
1.314685e-003 1.714741e-003 1.393692e-003 1.332473e-003
3.300501e-004 5.239898e-004 3.741254e-004 1.336304e-003
5.561366e-004 6.184441e-004 8.887792e-004 4.510226e-004
5.383913e-004 4.866397e-004 1.003825e-003 5.819744e-004
7.742675e-004 1.622945e-003 9.336277e-004
* 1 39724978 1.00 1024 10 6.378 5.178 1024.211 90 0.637 1.843
51 5.371094e-003 9.765625e-003 6.2661e-003 6.2937e+001 1.0732e+001 3.1663e-001
2.399138e-003 4.958530e-003 5.970532e-003 5.397915e-003
3.676770e-003 2.406614e-002 1.292470e-002 2.224974e-002
4.823480e-002 1.086449e-001 7.481066e-002 8.684431e-002
1.948858e-002 2.912741e-002 3.741619e-002 2.336472e-002
2.254591e-002 1.218159e-002 1.780615e-002 4.395502e-003
9.833613e-003 3.936535e-003 5.881464e-003 4.571996e-003
5.443738e-003 4.163474e-003 3.601095e-003 3.585647e-003
5.531514e-003 1.835893e-003 1.114426e-003 3.934834e-003
2.174772e-003 1.469032e-003 1.335585e-003 9.147523e-004
6.760068e-004 8.808380e-004 5.716856e-004 7.181183e-004
6.005655e-004 4.775679e-004 1.299268e-003 3.855911e-004
4.464863e-004 4.614029e-004 6.163178e-004 8.327592e-004
1.575676e-003 1.628755e-003 4.645250e-003
```

- First line - \* flags the beginning of the data for a wave burst. Line contains (in order):
  - Wave burst number
  - Start of wave burst (seconds since January 1, 2000)
  - Wave integration time (seconds)
  - Number of points in the wave burst
  - Number of spectral estimates for each frequency band
  - Water depth (meters)
  - Pressure sensor depth (meters)
  - Density ( $\text{kg/m}^3$ )
  - Chi-squared confidence interval (percent)
  - Multiplier for Chi-squared lower bound
  - Multiplier for Chi-squared upper bound
- Second line contains (in order):
  - Number of frequency bands calculated
  - Frequency of first frequency band (Hz)
  - Interval between frequency bands ( $\Delta f$ ) (Hz)
  - Total variance ( $\text{meters}^2$ )
  - Total energy ( $\text{joules / meters}^2$ )
  - Significant period (seconds) = frequency band with greatest variance
  - Significant wave height (meters) =  $4 \times \text{sqrt}(\text{total variance})$
- Third and following lines (until next line with \*) - Values (beginning with the first frequency) for the Auto-Spectral density function <Gaa>. Units are  $\text{meters}^2 / \text{Hz}$ . To obtain the variance ( $\text{m}^2$ ) in a frequency interval  $\Delta f$  (Hz), multiply the value of <Gaa> by  $\Delta f$ .

## Wave Burst Auto-Spectrum Report (.rpt extension)

A .rpt file is created from the .wb file in Process Wave Burst Data. A sample wave burst Auto-Spectrum report file is shown below:

```

surface wave processing summary:
file = apr12sp.wb
temperature = 15.000
salinity = 33.000
density = 1024.431
number of points per wave burst = 1028
sample period = 1.00 sec
burst # 1:
  mean pressure = 21.207 psia
  instrument depth = 4.466 meters
  total water depth = 5.666 meters
auto-spectrum:
  10 spectral estimates per band
  51 bands calculated
  each band is 0.010 Hz wide
  frequency span = 0.005 to 0.492 Hz

```

MM/DD	HH:MM	SIG.HT (CM)	SIG.PER (SEC)	ENERGY (CM.SQ.)									
				22+	20	17	15	13	11	9	7	5	3
04/05	15:42	31	11	1	0	0	2	2	19	13	10	10	3
04/05	18:42	32	11	2	2	0	1	2	15	18	11	7	4
04/05	21:42	46	3	2	2	0	2	3	7	12	15	8	82
04/06	00:42	39	9	1	3	0	2	5	10	13	14	8	39
04/06	03:42	41	18	3	13	0	6	2	6	17	11	9	41
04/06	06:42	45	10	4	2	0	8	3	10	21	12	13	56
04/06	09:42	49	8	2	2	0	11	2	13	23	27	29	42
04/06	12:42	57	16	1	5	0	28	5	6	28	17	43	71
04/06	15:42	61	16	1	5	0	59	3	9	27	18	60	50
04/06	18:42	67	16	6	2	0	72	37	9	17	12	52	70

The energy (centimeters squared) is the sum of the variance over the indicated frequency band:

- The 9 second wave period is the sum of the variances where the frequency is between 1/10 Hz and 1/8 Hz.
- The 20 second wave period is the sum of the variances where the frequency is between 1/22 Hz and 1/18 Hz.
- The 22+ second wave period is the sum of the variances of all the frequencies less than 1/22 Hz.

Significant period = 1 / (band averaged frequency with the greatest variance)

## Surface Wave Time Series Statistics (.wts extension)

A .wts file is created from the .wb file in Process Wave Burst Data. A sample surface wave time series statistics file is shown below:

```
SBE 26plus
* 0 39714178 1.00 1024 109 5.666 4.466 1024.431
6.860774e-003 6.892497e+001 1.972292e-001 7.431193e+000
6.293907e-001 3.115848e-001 9.138889e+000 4.114119e-001 6.293907e-001
* 1 39724978 1.00 1024 112 6.377 5.177 1024.431
6.632170e-003 6.662836e+001 1.914052e-001 7.223214e+000
4.505061e-001 3.078597e-001 9.000000e+000 3.902955e-001 4.505061e-001
```

- First line - \* flags the beginning of the data for a wave burst. Line contains (in order):
  - Wave burst number
  - Start of wave burst (seconds since January 1, 2000)
  - Wave integration time (seconds)
  - Number of points in the wave burst
  - Number of individual waves found
  - Water depth (meters)
  - Pressure sensor depth (meters)
  - Density ( $\text{kg/m}^3$ )
- Second line contains (in order):
  - Total variance of time series ( $\text{meters}^2$ )
  - Total energy of time series ( $\text{joules / meters}^2$ )
  - Average wave height (meters)
  - Average wave period (seconds)
- Third line contains (in order):
  - Maximum wave height (meters)
  - Significant wave height (meters) [average height of largest 1/3 waves]
  - Significant period (seconds) [average period of largest 1/3 waves]
  - $H_{1/10}$  (meters) [average height of largest 1/10 waves] -  
If less than 10 waves,  $H_{1/10}$  is set to 0
  - $H_{1/100}$  (meters) [average height of largest 1/100 waves] -  
If less than 100 waves,  $H_{1/100}$  is set to 0

## Surface Wave Time Series (.wt extension)

A .wt file is created from the .wb file in Process Wave Burst Data, if *Output surface wave time series to .wt file* is selected. Part of a sample surface wave time series file is shown below:

```
SBE 26plus
* 0 39714178 1.00 32
    -0.1783 -0.2180 -0.1793 -0.0721
    0.0615 0.1677 0.2036 0.1582
    0.0521 -0.0754 -0.1829 -0.2384
```

- First line - \* flags the beginning of the data for a wave burst. Line contains (in order):
  - Wave burst number
  - Start of tide measurement (seconds since January 1, 2000)
  - Wave integration period (seconds)
  - Number of points in wave burst
- Second and following lines (until the next line with \*) - Measured wave amplitudes in meters, with four values per line.

---

## Wave Burst Statistics Report (.r26 extension)

A .r26 file is created from the .was and .wts file in Create Reports. Part of a sample report file is shown below:

```
# filename = D:\SBE26\951002[.WAS, .WTS]
# wave integration time = 1.00
# number of points in the burst = 1024
# height of SBE 26 above the bottom = 0.300
# density = 1024.153
      Burst      Time-jdays      Time-hours      Depth      Nwaves      Avgheight      Avgper
Maxheight      H1/10      H1/100      Swp-wts      Swh-wts
3.384997e+00  0 232.67205 0.000 17.759 211 4.600717e-01 3.838863e+00
8.741022e-01 1 232.75538 2.000 17.679 185 2.278769e-01 4.383784e+00
8.741022e-01 7.083250e-01 8.741022e-01 6.344262e+00 5.092874e-01
```

- Beginning lines - # flags header. Header lines contain (in order):
  - Input file name
  - Wave integration period (seconds)
  - Number of points in the wave burst
  - Height of pressure sensor above bottom
  - Water density
- Column heading line and data – Data varies, depending on user-selected variables to be output.

# Appendix IV: Electronics Disassembly/Reassembly

Jackscrew kit



Sea-Bird provides a jackscrew kit with the SBE 26plus, to assist in removal of the connector end cap. The kit contains:

- 2 Allen wrenches
- 3 jackscrews
- 2 spare plastic socket hex-head screws

## Disassembly

### CAUTION:

Disconnect and dismantle the optional SBE 4M conductivity cell from the 26plus before disassembly to avoid breaking the conductivity cell.

1. Establish communications with the 26plus (see *Section 5: SBE 26plus Setup, Installation, and Data Upload - SeatermW* for details).  
**As a precaution, click Upload to upload any data in memory before beginning.**
2. Wipe the outside of the end cap and housing dry, being careful to remove any water at the seam between them.
3. Remove the four titanium hex-head screws securing the connector end cap to the housing.
4. Remove the three plastic hex-head screws from the end cap using the larger Allen wrench. Insert the three jackscrews in these three holes in the end cap. When you begin to feel resistance, use the smaller Allen wrench to continue turning the screws. Turn each screw 1/2 turn at a time. As you turn the jackscrews, the end cap will push away from the housing. When the end cap is loosened, pull it and the PCB assembly out of the housing.
5. Remove any water from the O-ring mating surfaces inside the housing with a lint-free cloth or tissue. Be careful to protect the O-rings from damage or contamination.
6. Disconnect the Molex connector connecting the PCB assembly to the battery compartment bulkhead.
7. Remove the jackscrews from the end cap.

Plastic hex-head screw  
(typical, 3 places)

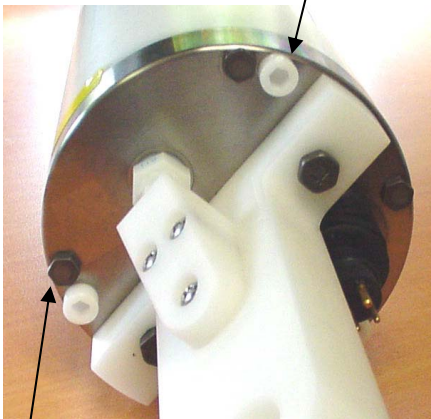

Titanium hex-head screw  
(typical, 4 places)

## Reassembly

**Note:**

Before delivery, a desiccant package is inserted in the housing and the electronics chamber is filled with dry Argon gas. These measures help prevent condensation. To ensure proper functioning:

1. Install a new desiccant bag each time you open the electronics chamber. If a new bag is not available, see *Application Note 71: Desiccant Use and Regeneration (drying)*.
2. If possible, dry gas backfill each time you open the housing. If you cannot, wait at least 24 hours before redeploying, to allow the desiccant to remove any moisture from the housing.

Note that opening the battery compartment does not affect desiccation of the electronics.

1. Remove any water from the O-ring and mating surfaces with a lint-free cloth or tissue. Inspect the O-ring and mating surfaces for dirt, nicks, and cuts. Clean or replace as necessary. Apply a light coat of O-ring lubricant (Parker Super O Lube) to O-ring and mating surfaces.
2. Reconnect the Molex connector to the PCB assembly. Verify the connector holds and pins are properly aligned.
3. Carefully fit the PCB assembly into the housing, aligning the holes in the end cap and housing.
4. Reinstall the 4 hex-head screws to secure the end cap to the housing.
5. Reinstall the 3 plastic hex head screws in the end cap.
6. Establish communications with the 26plus (see *Section 5: SBE 26plus Setup, Installation, and Data Upload - SeatermW* for details). Reset the date and time (**SetTime**) and initialize logging (**InitLogging**) before redeploying. No other parameters should have been affected by electronics disassembly (send **DS** to verify).

# Appendix V: AF24173 Anti-Foulant Device

*AF24173 Anti-Foulant Devices supplied for user replacement are supplied in polyethylene bags displaying the following label:*

## AF24173 ANTI-FOULANT DEVICE

FOR USE ONLY IN SEA-BIRD ELECTRONICS' CONDUCTIVITY SENSORS TO CONTROL THE GROWTH OF AQUATIC ORGANISMS WITHIN ELECTRONIC CONDUCTIVITY SENSORS.

### ACTIVE INGREDIENT:

Bis(tributyltin) oxide.....	53.0%
OTHER INGREDIENTS: .....	<u>47.0%</u>
Total.....	100.0%

### DANGER

See the complete label within the Conductivity Instrument Manual for Additional Precautionary Statements and Information on the Handling, Storage, and Disposal of this Product.

Net Contents: Two anti-foulant devices

Sea-Bird Electronics, Inc.  
13431 NE 20<sup>th</sup> Street  
Bellevue, WA 98005

EPA Registration No. 74489-1  
EPA Establishment No. 74489-WA-1

## AF24173 Anti-Foulant Device

FOR USE ONLY IN SEA-BIRD ELECTRONICS' CONDUCTIVITY SENSORS TO CONTROL THE GROWTH OF AQUATIC ORGANISMS WITHIN ELECTRONIC CONDUCTIVITY SENSORS.

**ACTIVE INGREDIENT:**

Bis(tributyltin) oxide.....	53.0%
OTHER INGREDIENTS: .....	47.0%
Total.....	100.0%

**DANGER**

See Precautionary Statements for additional information.

<b>FIRST AID</b>	
If on skin or clothing	<ul style="list-style-type: none"> <li>• Take off contaminated clothing.</li> <li>• Rinse skin immediately with plenty of water for 15-20 minutes.</li> <li>• Call a poison control center or doctor for treatment advice.</li> </ul>
If swallowed	<ul style="list-style-type: none"> <li>• Call poison control center or doctor immediately for treatment advice.</li> <li>• Have person drink several glasses of water.</li> <li>• Do not induce vomiting.</li> <li>• Do not give anything by mouth to an unconscious person.</li> </ul>
If in eyes	<ul style="list-style-type: none"> <li>• Hold eye open and rinse slowly and gently with water for 15-20 minutes.</li> <li>• Remove contact lenses, if present, after the first 5 minutes, then continue rinsing eye.</li> <li>• Call a poison control center or doctor for treatment advice.</li> </ul>
<b>HOT LINE NUMBER</b>	
<b>Note to Physician</b>	Probable mucosal damage may contraindicate the use of gastric lavage.
Have the product container or label with you when calling a poison control center or doctor, or going for treatment. For further information call National Pesticide Telecommunications Network (NPTN) at 1-800-858-7378.	

Net Contents: Two anti-foulant devices

Sea-Bird Electronics, Inc.  
13431 NE 20<sup>th</sup> Street  
Bellevue, WA 98005

EPA Registration No. 74489-1  
EPA Establishment No. 74489-WA-1



## PRECAUTIONARY STATEMENTS

### HAZARD TO HUMANS AND DOMESTIC ANIMALS

#### DANGER

**Corrosive** - Causes irreversible eye damage and skin burns. Harmful if swallowed. Harmful if absorbed through the skin or inhaled. Prolonged or frequently repeated contact may cause allergic reactions in some individuals. Wash thoroughly with soap and water after handling.

#### PERSONAL PROTECTIVE EQUIPMENT

##### USER SAFETY RECOMMENDATIONS

Users should:

- Remove clothing immediately if pesticide gets inside. Then wash thoroughly and put on clean clothing.
- Wear protective gloves (rubber or latex), goggles or other eye protection, and clothing to minimize contact.
- Follow manufacturer's instructions for cleaning and maintaining PPE. If no such instructions for washables, use detergent and hot water. Keep and wash PPE separately from other laundry.
- Wash hands with soap and water before eating, drinking, chewing gum, using tobacco or using the toilet.

#### ENVIRONMENTAL HAZARDS

Do not discharge effluent containing this product into lakes, streams, ponds, estuaries, oceans, or other waters unless in accordance with the requirements of a National Pollutant Discharge Elimination System (NPDES) permit and the permitting authority has been notified in writing prior to discharge. Do not discharge effluent containing this product to sewer systems without previously notifying the local sewage treatment plant authority. For guidance contact your State Water Board or Regional Office of EPA. This material is toxic to fish. Do not contaminate water when cleaning equipment or disposing of equipment washwaters.

#### PHYSICAL OR CHEMICAL HAZARDS

Do not use or store near heat or open flame. Avoid contact with acids and oxidizers.

#### DIRECTIONS FOR USE

It is a violation of Federal Law to use this product in a manner inconsistent with its labeling. For use only in Sea-Bird Electronics' conductivity sensors. Read installation instructions in the applicable Conductivity Instrument Manual.

**STORAGE AND DISPOSAL**

**PESTICIDE STORAGE:** Store in original container in a cool, dry place. Prevent exposure to heat or flame. Do not store near acids or oxidizers. Keep container tightly closed.

**PESTICIDE SPILL PROCEDURE:** In case of a spill, absorb spills with absorbent material. Put saturated absorbent material to a labeled container for treatment or disposal.

**PESTICIDE DISPOSAL:** Pesticide that cannot be used according to label instructions must be disposed of according to Federal or approved State procedures under Subtitle C of the Resource Conservation and Recovery Act.

**CONTAINER HANDLING:** Nonrefillable container. Do not reuse this container for any purpose. Offer for recycling, if available.

# Appendix VI: Wave Theory and Statistics

## Surface Gravity Waves - Description

### Types of Waves and Restoring Forces

The most characteristic physical feature of any kind of wave is the restoring force. If a medium at rest (such as still water) is disturbed in some way (by the wind, for example, or by dropping a rock into a pond), the restoring force acts to return the medium to its initial still state.

Compressibility is the restoring force for sound waves. Surface tension acts as the restoring force at any surface of contact between any two different fluids (like air and water), and produces very high frequency capillary waves. Gravity waves arise through the restoring force of gravity on water particles displaced from equilibrium levels. If the equilibrium level is a free surface (the boundary between water and air), surface gravity waves are formed. If the equilibrium level is an internal surface in a stratified fluid, internal gravity waves are formed. These internal waves tend to have longer periods (minutes to hours) than surface gravity waves (seconds). Finally, planetary effects such as rotation introduce restoring effects such as the Coriolis force and potential vorticity, yielding very long period waves called inertial waves, Rossby, and planetary waves.

### Spectrum of Surface Waves in the Ocean

Surface waves in the ocean occupy a broad range of wavelengths and periods.

- At extremely short periods, the spectrum is dominated by capillary waves, followed by a broad (1 - 20 second) band of surface gravity waves, mostly wind driven.
- Longer period (> 10 minutes) gravity waves may occur in association with earthquakes and large-scale meteorological systems (storm surges).
- Tides, which are another type of forced gravity wave, dominate the spectrum in the 12 - 36 hour band.
- At longer periods, *inertial* and *planetary* waves are prevalent; gravity does not play a dominant role any longer.

See Pond and Picard (Figure 12.1, Table 12.1) (*Appendix VIII: References*).

### Definition of Terms

$a$	= wave amplitude, [m]
$D_w$	= density of water, [Kg/m <sup>3</sup> ]
$E$	= $W_w H^2 / 8$ , total wave energy per unit area, [J/m <sup>2</sup> ]
$f$	= $1 / T$ , wave frequency, [Hz], [cycles/sec]
$g$	= 9.80665, acceleration of gravity, [m/sec <sup>2</sup> ]
$h$	= water depth, [m]
$H$	= $2a$ , wave height, [m]
$k$	= $2 \pi / L$ , wave number, [rad/m]
$L$	= wave length, [m]
$\phi$	= phase angle, [radians]
$\sigma$	= $2 \pi / T$ , radian frequency, [rad/sec]
$t$	= time, [sec]
$T$	= wave period, [sec]
$T_b$	= total time of the wave burst series (total sample period), [sec]
$W_w$	= $D_w g$ , specific weight of water, [Kg/(m <sup>2</sup> sec <sup>2</sup> )] = [Pa/m]
$x$	= horizontal distance, [m]
$z$	= instrument depth, [m]

### Basic Linear Wave Description

A traveling disturbance of the sea surface is commonly represented as a linear simple harmonic wave traveling in the  $x$  horizontal direction:

$$A(x,t) = a \cos(kx - \sigma t + \phi) \quad [1]$$

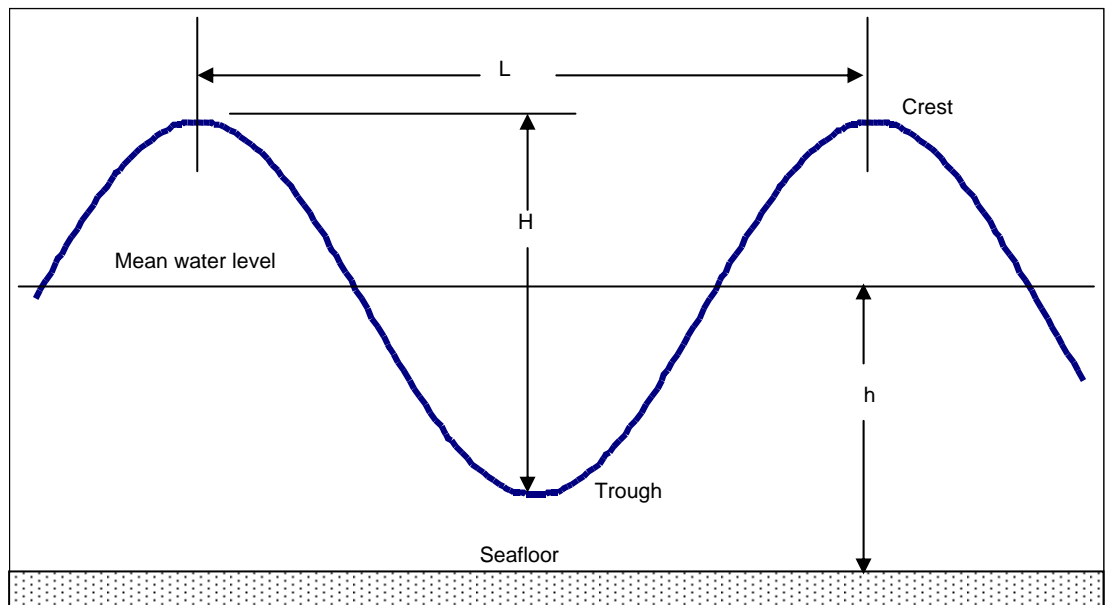

Simple-Harmonic Linear Wave Traveling on the Sea Surface

## Phase Angle

The phase angle  $\phi$  represents a shift of the wave relative to some reference time. This is useful for describing the relationships between a group of waves of different frequencies. When a time series is separated by spectral analysis methods into frequency components defined by [1], the two numbers that are computed for each frequency are:

amplitude	$a(f)$
phase	$\phi(f)$

The physical time lag associated with a given phase depends on the wave period ( $T$ ). For example, a phase of  $\pi$  radians implies a time lag of 5 seconds for a wave with a period of 10 seconds ( $T = 10$  sec), while the same phase implies a lag of 2.5 sec for a wave with  $T = 5$  sec.

## Dispersion Equation

For surface gravity waves described by [1], there is a special relationship between wave period and wave length. This relationship, which depends on water depth, is called the dispersion relation and is given by:

$$\sigma^2 = gk \tanh(kh) \quad [2]$$

## Implications of Linear Theory

Equation [1] represents a single frequency-wavenumber component of a sea surface that usually contains a whole group of waves of different sizes, lengths, and propagation directions. One of the major assumptions of linear theory is that we can take this jumbled combination and treat each frequency component (or frequency band) separately by using [1].

First order linear *small amplitude* theory is the simplest and most direct solution to a very complex general set of equations and boundary conditions for surface gravity waves. The simple results are based on a set of approximations that are strictly valid only over a restricted range of conditions. Small amplitude wave theory is not a good model of steep or breaking waves, or waves traveling in very shallow water. The theory is a good model of long ocean waves away from viscous boundary layers and horizontal boundaries.

## Assumptions

For the linear theory to be valid, a major requirement is that the wave height  $H$  be small compared with both the wavelength  $L$  and the water depth  $h$ . These conditions are usually expressed as:

$$H / L \ll 1 \quad (\text{wave steepness})$$

$$H L^2 / h^3 \ll 1 \quad (\text{Ursell parameter})$$

Another measure of the effect of wave steepness on the validity of the small amplitude theory, based on laboratory measurements, is shown below. For the theory to be valid, you must be below the curve indicated. For example, if the wave period of interest  $T$  is 10 sec and the water depth  $h$  is 100 meters, the parameter  $h / gT^2 = 0.1$ . This means that  $H / gT^2$  must be less than 0.001 for the theory to be valid, which translates into a maximum wave height of 1 meter.

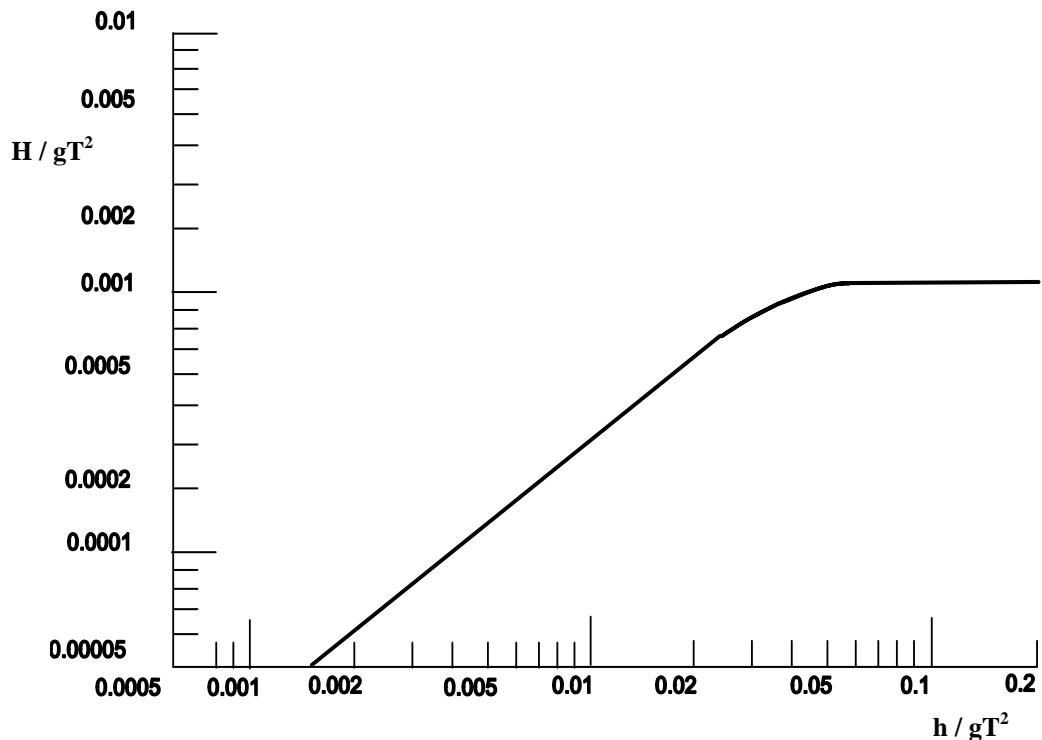

**Range of Validity of Linear Wave Theory**  
(Theory Valid for Values Below Curve)

A final rule of thumb is that estimates of surface wave heights should be accurate within  $\pm 5\%$  provided:

$$z / L < 0.3 \text{ to } 0.5,$$

where  $z$  is the depth of the instrument below the surface and  $L$  is the wavelength of the observed waves.

## Subsurface Pressure Due to Surface Gravity Waves

As a surface wave passes over a subsurface position, the elevation and depression of the sea surface causes a differential subsurface pressure disturbance. This pressure disturbance decays with depth according to the relation:

$$p = W_w A(t) K(f,z) \quad [\text{Pa}] \quad [3]$$

where the vertical pressure response function is:

$$K(f,z) = \cosh[k(h-z)] / \cosh(kh) \quad [\text{dimensionless}] \quad [4]$$

where

$A(t)$  (defined by [1]) = water surface displacement, which varies between +a and -a meters

$W_w$  = specific weight of water near the surface

$h$  = water depth

$k$  = wave number [radians/m], calculated for a given wave period and depth with the dispersion relation [2]

$z$  = vertical distance [m] from the measurement point to the mean (undisturbed) water surface

Equation [3] is the essential result required to relate subsurface pressure to surface wave height. For a given pressure frequency component  $P(f)$ , the transfer function used to obtain surface wave amplitude  $a(f)$  from subsurface pressure is:

$$a(f) = P(f) / W_w K(f,z) \quad [\text{m}] \quad [5]$$

For deep water waves ( $kh \gg 1$  and  $h/L > 0.5$ ) equation [3] takes the form:

$$p \approx W_w A e^{-kz} \quad [\text{Pa}] \quad [6]$$

which clearly represents an exponential decay with depth.

For shallow water waves ( $hk \ll 1$  and  $h > L/2$ ) equation [3] takes the form:

$$p \approx W_w A \quad [\text{Pa}] \quad [7]$$

which is simply the hydrostatic equation.

The table below, developed with Plan Deployment, shows pressure attenuation [p(bottom) / p(surface)] vs. bottom depth for waves with T = 2, 5, 10, 20, and 25 seconds.

Water Depth [meters]	Sensor Height above Bottom [meters]	Wave Period [seconds]				
		25	20	10	5	2
2	0	0.99	0.99	0.96	0.84	0.25
4	0	0.99	0.98	0.92	0.70	0.04
8	0	0.97	0.96	0.84	0.45	-----
15	0	0.95	0.93	0.72	0.17	-----
20	0	0.94	0.90	0.63	0.08	-----
30	0	0.91	0.85	0.48	0.02	-----
40	0	0.87	0.81	0.35	-----	-----
50	0	0.84	0.76	0.25	-----	-----
75	0	0.77	0.65	0.1	-----	-----
100	0	0.70	0.55	0.04	-----	-----

Pressure attenuation [p(bottom) / p(surface)] for various bottom depths and wave periods (----- = less than 0.001).

### High Frequency Cutoff

The table above shows that the pressure attenuation with depth is a strong function of the wave period; short period waves attenuate much faster with depth than longer period waves. This implies that for a pressure sensor deployed at a fixed depth  $z$ , there is a high frequency cutoff  $f_{max}$  for which waves with  $f > f_{max}$  are not measurable. Above the high frequency cutoff, any noise in the subsurface pressure record is mapped by the transfer function into unrealistic surface wave height values. The default high frequency cutoff for Process Wave Burst Data is the frequency where the ratio of pressure measured by the SBE 26plus to pressure at the surface is less than  $(0.0025 / \text{wave sample duration})$  [see equation 20]. Frequencies greater than  $f_{max}$  are not processed by Process Wave Burst Data for most applications.

**Note:**

Frequencies greater than  $f_{max}$  are processed if *Use filter cutoff* is selected in Process Wave Burst Data.

*Example:*

Water depth is 10 meters. You are interested in measuring waves with frequencies up to 0.36 Hz (period =  $1 / 0.36 = 2.8$  seconds). You plan to sample waves 4 times per second (wave sample duration = 0.25 seconds) with 1024 samples per wave burst, and to process data with 10 spectral estimates/band. Can you place the 26plus at 1 meter above the bottom and accomplish your goals?

Running Plan Deployment with the above parameters, the Frequency Span is 0.0215 to 0.3340 Hz. Since  $0.334 < 0.37$ , you cannot accomplish your goals.

Iterating on a solution by changing the instrument height in Plan Deployment, you find that placing the 26plus at 2.5 meters above bottom will allow you to measure the desired frequencies. Alternatively, you could consider modifying other sampling parameters while maintaining the instrument height.



## Wave Processing Steps

To compute surface wave energy spectra and statistics, the frequency dependent attenuation must first be removed from the subsurface pressure data. Fourier analysis techniques are used to decompose the subsurface time series into a group of linear wave components, each with a distinct frequency, amplitude, and phase.

### Initial Processing of Pressure Data

First the wave burst data is read into an array. The mean is computed and then the mean and trend are removed from the array. A trend is expected in the wave data due to tides and other low frequency waves. If these trends are not removed, distortions can occur in the processing of spectral estimates; the *ramp* function in the time domain leaks all over the spectrum in the frequency domain.

Density ( $D_w$ ) is computed from the user-supplied salinity and temperature.

Instrument depth ( $z$ ) and water depth ( $h$ ) are computed by:

$$z = 6894.757 (\text{mean pressure} - 14.7) / D_w g \quad [\text{m}] \quad [8]$$

$$h = z + \text{height of pressure sensor above bottom} \quad [\text{m}] \quad [9]$$

where the factor 6894.757 is used to convert the pressure from psi to Pascals.

If the number of wave samples is not a power of two, the array length is made a power of two by filling it with the last de-measured and de-trended pressure value.

Next, a Hanning window is applied to the time series to suppress the spectral leakage that occurs when the time series to be Fourier transformed contains a periodic signal that does not correspond to one of the exact frequencies of the FFT. Physically, this means that an integral number of waves does not fit in the time series. When this occurs, energy at one frequency leaks to other frequencies. This causes errors when applying the frequency dependent dispersion transfer function to the transformed data. The Hanning window has the form:

$$u(t) = 1 - \cos^2(\pi t / T_b) \quad 0 \leq t \leq T_b \quad [10]$$

The windowing operation reduces the total energy in the time series so each element is multiplied by the scale factor SF, where

$$SF = (8/3)^{1/2} \quad [11]$$

to obtain the correct magnitudes in later spectral estimates.

Finally, each element in the time series is multiplied by the factor 6894.757 to convert the measured pressure from psi to Pascals.

## Surface Wave Auto-Spectrum

The Finite Fourier transform of a time series with  $N$  points contains  $N$  raw spectral estimates at frequencies given by:

$$F_j = j / T_b \quad j = 0, N-1 \quad [\text{Hz}] \quad [12]$$

where  $T_b$  is the total time of the series (seconds). The first spectral estimate ( $j = 0$ ) is the mean of the time series, and is 0 since the subsurface pressure time series has been de-meant.

The interval between spectral estimates (resolution bandwidth) is:

$$\delta f = 1 / T_b = 1 / (N\delta t) \quad [13]$$

where  $\delta t$  is the time interval between samples in the subsurface pressure time series.

While  $N$  raw spectral estimates are computed, only the first  $(N/2 + 1)$  are unique. For a real input time series the second  $(N/2 - 1)$  values are identical to the first  $N/2$  values. The limiting frequency is the Nyquist frequency, given by:

$$\text{Nyquist} = 1 / (2\delta t) \quad [\text{Hz}] \quad [14]$$

The forward Fourier transform of the time series is defined by:

$$Z_j = (1 / N) \sum_{n=0}^{N-1} x_n \exp(-i 2 \pi n j / N) \quad [15]$$

where

$Z_j$  (the raw spectral estimates) are complex numbers.

$i = (-1)^{1/2}$

The raw spectral estimates are directly related to the single frequency wave described in [1]:

$$a_j = 2 |Z_j|, \quad \varphi_j = \arg(Z_j) \quad [16]$$

The variance at each frequency is:

$$\text{var}_j = |Z_j|^2, \quad j = 1, N-1 \quad [17]$$

The total variance of the spectrum:

$$\text{var}_{\text{total}} = \sum_{j=1}^{N-1} |Z_j|^2 \quad [\text{Pa}^2] \quad [18]$$

is equal to the variance calculated from the time series [28].

For each frequency up to the Nyquist, the relationship between the single pressure wave variance [1] and [17] is:

$$a_j^2 / 2 = 2 \text{var}_j \quad [19]$$

Once the Fourier transform has been obtained, the Fourier coefficients for the frequencies greater than  $f_{\max}$  and less than  $f_{\min}$  are *typically* set to 0.0:

$$f_{\max} = \text{minimum of:} \\ \text{frequency where ( subsurface / surface pressure = } 0.0025 / \delta t ) \quad [20]$$

**or**

$$1 / \text{user input minimum period} \quad [21]$$

$$f_{\min} = 1 / \text{user input maximum period} \quad [22]$$

Maximum frequency limits prevent noise in the subsurface time series from being mapped by the dispersion transfer function into unrealistic wave heights.

If the user selected *Use filter cutoff*, a filter is applied that ramps the Fourier coefficients down to 0 for frequencies greater than  $f_{\max}$  and less than  $f_{\min}$ .

- For frequencies less than  $f_{\min}$ :  
fourier coefficient =  $f * \exp ([f - f_{\min}] / f_c)$
- For frequencies greater than  $f_{\max}$ :  
fourier coefficient =  $f * \exp ([f_{\max} - f] / f_c)$

where

$f$  = frequency

$f_c$  = user input filter value

A copy of the Fourier transform is saved; it will be used to recover the surface wave time series.

### Band Averaging

Each raw spectral estimate contains two degrees of freedom. Band averaging can be used to increase the number of degrees of freedom and reduce the error of the estimate. The number of degrees of freedom ( $n_d$ ) associated with grouping  $n_f$  spectral estimates in a frequency band of width  $\delta f$  is twice the number of frequencies in the band.  $\delta f = n_f / T_b$

Band averaging is performed by adding up the total variance in a frequency band and dividing the sum by the width (Hz) of the frequency band ( $\delta f$ ). For positive frequencies less than the Nyquist, the estimate of the one-sided subsurface pressure auto-spectral density function for a frequency band centered at  $f_b$  is:

$$\langle G_{pp}(f_b) \rangle = \frac{2 \sum_{k=1}^{n_f} |Z_k|^2}{\delta f} \quad [\text{Pa}^2 \text{ sec}] \quad [23]$$

### Confidence Intervals (Error Bars)

The properties of a *real-world* (random) time series cannot be precisely determined from sample data. Only estimates of the parameters of interest can be obtained. The method for setting error bars on the estimates of the auto-spectral density function  $\langle G_{pp} \rangle$  is related to the Chi-Square distribution function:  $X^2$ .



A plot of the surface wave auto-spectral density function  $G_{aa}$  with error bars is probably the most useful way of describing the sea surface shape due to a surface wave field. A glance at the spectrum shows where the wave variance is in frequency space.

The surface wave spectral density function  $G_{aa}$  has units of  $[m^2 \text{ sec}]$ . To find the variance  $[m^2]$  in a frequency interval  $\delta f$  (Hz), multiply  $G_{aa}$  by  $\delta f$ .

### Total Variance and Energy

The total variance  $\text{Var}_{\text{tot}}$  is the sum of all the band-averaged spectral estimates:

$$\text{var}_{\text{tot}} = \sum_{k=1}^{n_b} G_{aa}(f_k) \delta f \quad [m^2] \quad [27]$$

where

$\delta f$  is the number of spectral estimates in the band divided by the total sample period,

$n_b$  is the number of frequency bands computed,

$G_{aa}(f_k)$  is the spectral estimate for the frequency centered at  $f_k$ .

The total wave energy ( $J / m^2$ ) is found by multiplying the total variance by the specific weight of water ( $W_w$ ).

### Significant Wave Height and Period

The significant wave height is the average height of the highest 1/3 of the waves and is estimated from the auto-spectrum as:

$$H_{1/3} = 4 (\text{Var}_{\text{tot}})^{1/2} \quad [m] \quad [28]$$

The significant wave period estimated from the auto-spectrum is the period corresponding to the frequency with the highest variance.

### Surface Wave Time Series

To reconstruct the surface wave time series from the subsurface pressure, the transfer function  $H(f_i)$  [see equation 26] is applied frequency by frequency to the scaled raw spectral estimates:

$$A(f_i) = H(f_i) P(f_i) \quad f_i \leq \text{Nyquist} \quad [29]$$

where  $A(f_i)$  are the raw spectral estimates of surface wave amplitude and  $P(f_i)$  are the spectral estimates of subsurface pressure. The spectral estimates for  $f_i > \text{Nyquist}$  are given by  $A(f_{n-i}) = A(f_i)$ .

The Inverse Fast Fourier Transform (IFFT) is taken to construct the surface time series.

The influence of the Hanning window is removed with a deconvolution in the time domain; each point  $x_i$  is multiplied by the inverse of the Hanning window  $w_i$  corresponding to the same time point. This procedure is unstable near the end points where  $w_i \approx 0$ . Therefore, the time series is set to 0 at the beginning and end where the window reaches 1% of its maximum value.

Finally, each point in the time series is multiplied by  $1 / \sqrt{8/3}$  to compensate for the initial scaling of the time series.

### Total Variance and Energy

The unbiased sample variance is a fundamental statistical measure of the time series. Variances from different bursts can be compared to see if the wave field is stationary or changing. The unbiased estimator for the variance is:

$$\langle \sigma_x^2 \rangle = (1 / [N-1]) \sum_{j=0}^{N-1} |x_j - \langle \mu_x \rangle|^2 \quad [\text{m}^2] \quad [30]$$

where  $\mu_x$  is the sample mean. In this case, the mean is zero since the time series has been de-meant. The variance obtained from the reconstructed time series can be compared with the total variance obtained from the auto-spectrum [25] as a check on the *goodness* of the time series reconstruction.

An estimate of the total wave energy contained in the record is:

$$E = W_w \langle \sigma_x^2 \rangle \quad [\text{J} / \text{m}^2] \quad [31]$$

### Average Wave Height and Period: $H_{\text{avg}}$ , $T_{\text{avg}}$

Since the wave time series is typically very irregular due to the random nature of the sea surface, the calculation of wave heights and periods can only be approximate and statistical. A standard method for estimating wave heights and wave periods is summarized in the Handbook on Wave Analysis and Forecasting, from the World Meteorological Organization (WMO- No. 446, 1976, Geneva, Switzerland) and illustrated below:

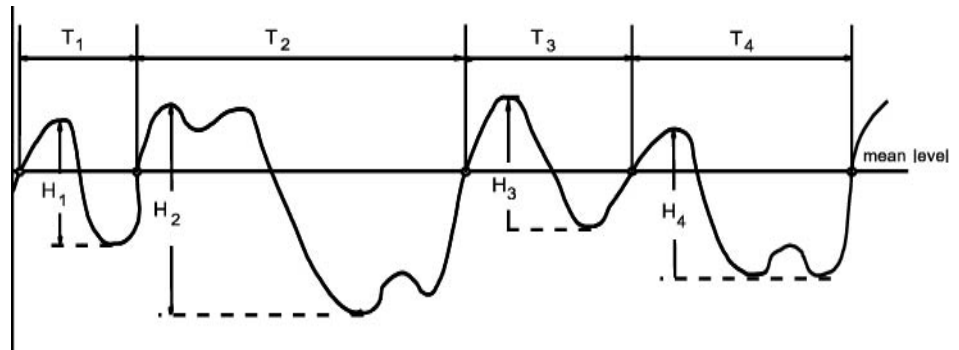

### Zero-Crossing Method for Estimating Wave Heights and Periods from a Wave Time Series

Individual *waves* are isolated by identifying the zero *upcrossings*;  $H$  and  $T$  for each captured wave is stored in an array. Averaging over all the captured waves yields the average wave height  $H_{\text{avg}}$  (meters) and the average period  $T_{\text{avg}}$  (seconds).  $H_{\text{max}}$  is the largest captured wave.

**Sea State (Significant Wave Height)**

The significant wave height ( $H_{1/3}$ ) and average period ( $T_{\text{avg}}$ ) define the sea state.  $H_{1/3}$  is the average height of the highest 1/3 of the waves and has physical significance because it is the approximate wave height picked out visually and reported by trained observers at sea.

$T_{1/3}$  is obtained by picking out the highest 1/3 of the captured waves and averaging their periods.

The parameters  $H_{1/10}$  and  $H_{1/100}$  are similarly defined as the average height of the highest 10 and 1 percent of the captured waves, respectively.

# Appendix VII: Pressure-to-Depth Conversion

Force is mass \* acceleration, units are Newtons [N]:

$$N = \text{Kg m} / \text{sec}^2$$

Density ( $\rho$ ) is mass / volume, units are [ $\text{Kg} / \text{m}^3$ ]:

This is the *in situ* value, and is approximately  $1025 \text{ Kg} / \text{m}^3$  at the surface.

Specific weight (W) is weight / volume, units are [ $\text{N} / \text{m}^3$ ]:

$$W = \rho * g$$

where  $g$  = local gravity [ $\text{m} / \text{sec}^2$ ]

Hydrostatic equation:

$$p = p_{\text{atm}} + W * z$$

$p_{\text{atm}}$  = atmospheric pressure in Pascals [ $\text{N} / \text{m}^2$ ]

$p$  = total pressure in Pascals [ $\text{N} / \text{m}^2$ ]

W is average density times gravity [ $\text{N} / \text{m}^3$ ]

$z$  = depth [m]

Conversions:

$$1 \text{ Pascal} = 10^{-4} \text{ decibars}$$

$$1 \text{ psi} = 0.6894757 \text{ decibars}$$

*Example:*

$$\text{average density} = 1025 \text{ kg} / \text{m}^3$$

$$\text{average gravity} = 9.8 \text{ m} / \text{sec}^2$$

$$\text{pressure reading} = 6000 \text{ decibars} = 6 \times 10^7 \text{ Pascals}$$

$$\text{atmospheric pressure} = 14.7 \text{ psia} = 1.013529 \times 10^5 \text{ Pascals}$$

$$W = 1025 * 9.8 = 10045 \text{ [N} / \text{m}^3]$$

$$6 \times 10^7 - 1.013529 \times 10^5 = 10045 * z$$

$$z = 5.989865 \times 10^7 / 10045 = 5963.031 \text{ meters}$$



# Appendix VIII: References

## Textbooks:

Bendat, J.S. and A.G. Piersol, 1986. *Random Data, Analysis and Measurement Procedures*, 2<sup>nd</sup> edition, Wiley, New York, ISBN 0-471-04000-2.

Bevington, P.R., 1969. *Data Reduction and Error Analysis for the Physical Sciences*, McGraw-Hill, New York.

Freund, J.E., 1962. *Mathematical Statistics*, Prentice Hall, EngleWood Cliffs, N.J.

LeBlond, P.H., and L.A. Mysak, 1978. *Waves in the Ocean*, Elsevier Amsterdam, ISBN 0-444-41602-1.

Neumann and Pierson, 1966. *Principles of Physical Oceanography*, Prentice Hall, EngleWood Cliffs, N.J.

Pond and Picard, 1983. *Introductory Dynamical Oceanography*, 2nd Ed., Pergamon Press, New York, ISBN 0-08-028728-X

Press, W. H., et. al., 1986. *Numerical Recipes*, Cambridge University Press, New York.

## Reports:

Earle, M.D. and J.M. Bishop. 1984. *A Practical Guide to Ocean Wave Measurement and Analysis*, Published by: ENDECO, Inc., Marion, MA.

*Handbook on Wave Analysis and Forecasting*, 1976. World Meteorological Organization, Geneva, ISBN 92-63-10446-8.

Knowles, C.E., 1981. Estimation of surface gravity waves from subsurface pressure records for estuarine basins. UNC Sea Grant College Publication UNC-SG-WP-81-6.

Morang, A, 1990. *Quality Control and Management of Oceanographic Wave-Gauge Data*, Instruction Report CERC-90-1, Department of the Army, Waterways Experiment Station, Corps of Engineers, Vicksburg, Mississippi.

## Scientific Publications:

Bergan, A.O., A. Torum and A. Tratteberg, 1968. Wave measurements by pressure type wave gauge. Proc. 11th Coastal Eng Conf., ASCE, 1: 19-29.

Bishop, C.T. and M.A. Donelan, 1987. Measuring waves with pressure transducers. *Coastal Eng.*, 11: 309-328.

Forrinstall, G.Z., 1982. Subsurface Wave-Measuring Systems, in: *Measuring Ocean Waves*, National Academy Press, Washington D.C., pp. 194-209.

Grace, R.A., 1970. How to measure waves. *Ocean Ind.*, 5(2): 65-69.

Hom-ma, M., K. Horikawa and S. Komori, 1966. Response characteristics of underwater wave gauge. Proc. 10th Coastal Eng. Conf., ASCE, 1: 99-114.

Michel, W.H., 1968. Sea Spectra Simplified. *Marine Technology*, January 1968: 17-30.

Wang, H., D. Lee and A. Garcia, 1986. Time series surface wave recovery from pressure gage, *Coastal Engineering*, 10: 379-393.

# Appendix IX: Replacement Parts

Part Number	Part	Application Description	Quantity in 26plus
22018	Batteries, alkaline D-cell, Duracell MN1300 (LR20)	Power 26plus	12
41124B	Battery cover plate	Retains <b>alkaline</b> D-cell batteries	1
801575	Battery cover plate/spacer	Retains <b>lithium</b> DD-cell batteries with buttons	-
50092	SBE 16/19 Jackscrew Kit	For removing connector end cap	1
60021	Spare battery end cap hardware and o-rings	O-rings and hardware, including: <ul style="list-style-type: none"> <li>• 30145 Screw, 6-32 x 1/2" Phillips-head, stainless steel (secures battery cover plate to battery posts)</li> <li>• 30242 Washer, #6 flat, stainless steel (for screw 30145)</li> <li>• 30816 Parker 2-234E603-70 (battery end cap to housing piston seal)</li> <li>• 30090 Parker 2-153N674-70 (battery end cap to housing face seal)</li> </ul>	-
50056	Spare parts kit	Assorted hardware and o-rings, including: <ul style="list-style-type: none"> <li>• 30145 Screw, 6-32 x 1/2" Phillips-head, stainless steel (secures battery cover plate to battery posts)</li> <li>• 30242 Washer, #6 flat, stainless steel (for screw 30145)</li> <li>• 30447 Bolt 1/4-20 x 1 1/4 Hex, titanium (secures life eye to connector end cap and plastic bar to battery end cap)</li> <li>• 30493 Machine screw, 10-24 x 1 1/4 Hex, titanium (secures connector end cap to housing)</li> <li>• 30552 Retaining ring (secures mooring pin for optional mounting fixture to lift eye)</li> <li>• 30816 Parker 2-234E603-70 (battery end cap to housing piston seal)</li> <li>• 30090 Parker 2-153N674-70 (battery end cap to housing face seal)</li> <li>• 30815 Parker 2-233E603-70 (connector end cap to housing radial piston seal)</li> </ul>	-

*Continued on next page*

Continued from previous page

Part Number	Part	Application Description	Quantity in 26plus
17695	3-pin RMG-3FS to 3-pin RMG-3FS cable, 0.28 m (11 in.) long	From 26plus to optional conductivity sensor	1
171752	3-pin to MCIL-3FS (wet-pluggable connector) to 3-pin RMG-3FS cable, 0.28 m (11 in.) long	From 26plus to optional conductivity sensor	1
801225	4-pin RMG-4FS to DB-9S data I/O cable, 2.4 m (8 ft) long	From 26plus to computer, for standard RS-232 interface	1
801374	4-pin MCIL-4FS (wet-pluggable connector) to DB-9S data I/O cable, 2.4 m (8 ft) long	From 26plus to computer, for standard RS-232 interface	1
801584	6-pin AG-206 to DB-9S data I/O cable, 2.4 m (8 ft) long	From 26plus to computer, for optional RS-422 / RS-485 interface	1
171888	25-pin DB-25S to 9-pin DB-9P cable adapter	For use with computer with DB-25 connector	-
17043	Locking sleeve	Locks I/O cable or dummy plug in place	2
171192	Locking sleeve (wet-pluggable connector)	Locks I/O cable or dummy plug in place	2
17045.1	3-pin RMG-3FS dummy plug with locking sleeve	For when optional conductivity sensor not used	1
171500.1	3-pin MCDC-3-F (wet-pluggable) dummy plug with locking sleeve	For when optional conductivity sensor not used	1
17046.1	4-pin RMG-4FS dummy plug with locking sleeve	For RS-232 I/O connector during deployment	1
171398.1	4-pin MCDC-4-F (wet-pluggable) dummy plug with locking sleeve	For RS-232 I/O connector during deployment	1
17047.1	6-pin AG-206 dummy plug with locking sleeve	For RS-422 / RS-485 I/O connector during deployment	1
801542	AF24173 Anti-Foulant Device	For use with optional conductivity sensor – Bis(tributyltin) oxide device inserted into anti-foulant device cup in mount kit	1 (set of 2)
50315	Anti-foulant device mount kit	Mounts on ends of conductivity cell to hold AF24173 Anti-Foulant Devices	1
30411	Triton X-100	Octyl Phenol Ethoxylate – Reagent grade non-ionic cleaning solution for conductivity cell (supplied in 100% strength; dilute as directed)	1
50102	Mounting fixture	Optional mounting fixture with mooring lock pin	1

# Index

---

## A

Anti-Foulant Devices · 119

---

## B

Barometric pressure · 57  
 Batteries · 13  
   replacing · 76  
 Battery and Memory Endurance · 21  
 Battery endurance · 21  
 Baud · 34  
 Baud rate · 14, 15

---

## C

Cable length · 15  
 Calibration · 81  
 Calibration coefficients · 46  
 Calibration coefficients · 81  
 Cleaning · 75, 80  
 Commands  
   baud · 34  
   calibration coefficients · 46  
   conductivity · 34  
   data upload · 43, 52  
   date and time · 34  
   descriptions · 30  
   diagnostic · 44  
   general setup · 34  
   initialize logging · 40  
   logging · 41  
   memory upload · 43, 52  
   polled sampling · 43  
   real-time data · 35, 37  
   reset memory · 40  
   send last sample · 43  
   start and stop · 37, 41  
   status · 32  
   summary · 88  
   temperature · 34  
   testing · 44  
   tide setup · 36  
   troubleshooting · 44  
   upload · 43, 52  
   wave setup · 36  
 Communication defaults · 26  
 Conductivity · 34  
 Conductivity sensor  
   maintenance · 80  
 conductivity sensor calibration · 83  
 Connector · 75  
 Connectors · 12  
 Convert Hex · 54  
 Corrosion precautions · 75  
 Create Reports · 64

---

## D

Data format · 18, 98  
   .cap · 98  
   .hex · 100, 106  
   .r26 · 116  
   .rpt · 114

  .tid · 112  
   .was · 113  
   .wb · 112  
   .wt · 116  
   .wts · 115  
   converted data · 112  
   Quartz · 100  
   strain gauge · 106  
   surface wave time series · 116  
   tide data · 112  
   uploaded data · 100, 106  
   wave auto-spectrum report · 114  
   wave auto-spectrum statistics · 113  
   wave data · 112  
   wave statistics · 116  
   wave time series statistics · 115  
 Data I/O · 14  
 Data upload · 43, 52  
 Date and time · 34  
 Deployment · 50  
 Depth to pressure conversion · 136  
 Diagnostic · 44  
 Dimensions · 12

---

## E

Electronics disassembly/reassembly · 117  
 End cap · 75  
 End cap connectors · 12  
 Extensions · 18, 98  
 External power · *See* Power, external  
 Extract Tide · 54  
   installation · 16

---

## F

File extensions · 18, 98  
 File formats · 18, 98  
 Format · 18, 98  
   .cap · 98  
   .hex · 100, 106  
   .r26 · 116  
   .rpt · 114  
   .tid · 112  
   .was · 113  
   .wb · 112  
   .wt · 116  
   .wts · 115  
   converted data · 112  
   Quartz · 100  
   real-time data · 98  
   strain gauge · 106  
   surface wave time series · 116  
   tide data · 112  
   uploaded data · 100, 106  
   wave auto-spectrum report · 114  
   wave auto-spectrum statistics · 113  
   wave data · 112  
   wave statistics · 116  
   wave time series statistics · 115

---

**G**

General setup · 34  
Glossary · 86

---

**I**

Initialize logging · 40  
Installation · 16, 50

---

**L**

Limited liability statement · 2  
Logging · 41

---

**M**

Maintenance · 75  
Measurement sequence · 91  
Measuring tides only · 48  
Measuring waves only · 48  
Memory · 10  
Memory endurance · 21  
Memory upload · 43, 52  
Merge barometric pressure · 57

---

**P**

Parity · 14  
Parker Super O-Lube · 87  
Parts  
    replacement · 138  
Photos · 7  
Plan Deployment · 19  
Plot Data · 68  
Polled sampling · 43  
Power · 13  
    external · 13  
Power consumption · 10  
Power endurance · 21  
Pressure attenuation · 19  
Pressure sensor  
    maintenance · 77  
Pressure sensor calibration · 81  
Pressure to depth conversion · 136  
Process Wave Burst Data · 60  
Programming for deployment · 25

---

**Q**

Quick start · 6

---

**R**

Real-time data · 35, 37  
Real-time data format · 98  
Real-time setup  
    baud rate · 15  
    cable length · 15  
Recovery · 51  
References · 137  
Replacement parts · 138  
Reset memory · 40

---

**S**

Sample timing · 91  
SBE 4M  
    maintenance · 80  
SEASOFT for Waves · 17  
    Convert Hex · 54  
    Create Reports · 64  
    Extract Tide · 54  
    file extensions · 18, 98  
    file formats · 18, 98  
    installation · 16  
    Merge Barometric Pressure · 57  
    Plan Deployment · 19  
    Plot Data · 68  
    Process Wave Burst Data · 60  
    SeatermW · 25  
        statistics · 123  
        theory · 123  
        updates · 16  
    SeatermW · 25  
Send last sample · 43  
Sensors · 10  
Separating wave and tide data · 54  
Sequence · 91  
Setting time · 34, 49  
Setting up SBE 26*plus* · 25  
Software  
    statistics · 123  
    theory · 123  
Software use · 17  
Specifications · 10  
Start and stop logging · 37, 41  
Statistics · 123, 137  
Status · 32  
Storage · 75, 80  
Super O-Lube · 87  
Synchronizing time · 49

---

**T**

Temperature · 34  
Temperature sensor calibration · 82  
Testing · 44  
Testing SBE 26*plus* · 25  
Theory · 123, 137  
Tide data · 112  
Tide data plotting · 68  
Tide data processing · 54, 57  
Tide setup · 36  
Tides only · 48  
Time · 34, 49  
Timing · 91  
Triton · 87  
Troubleshooting · 44  
Troubleshooting · 84

---

**U**

Unpacking · 7  
Updates · 16  
Upload · 43, 52

---

**W**

- Wave Burst Data · 60
- Wave data · 112
- Wave data auto-spectrum report · 114
- Wave data auto-spectrum statistics · 113
- Wave data plotting · 68
- Wave data processing · 54, 60, 64
- Wave data surface wave time series · 116
- Wave data time series statistics · 115
- Wave data wave burst statistics · 116
- Wave setup · 36
- Waves only · 48