

-This page intentionally left blank -

SATLANTIC

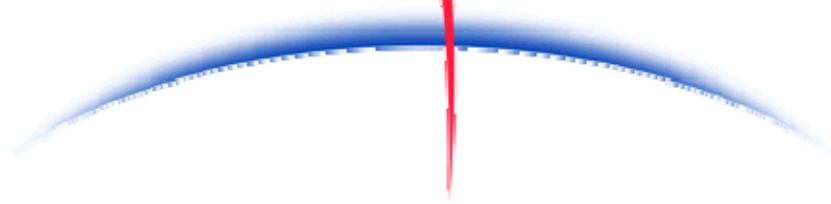

**Operation Manual for the  
Profiler II**

Document No. SAT-DN-00223  
Revision I, September 2008

INSTRUMENT OPERATION MANUAL

[www.satlantic.com](http://www.satlantic.com)



**-This page intentionally left blank -**



**Operation Manual For: Profiler II  
Document Number: SAT-DN-00223  
Rev I**

**Prepared by:** Satlantic Incorporated  
3481 North Marginal Road  
Halifax, Nova Scotia  
B3K 5X8  
Tel (902) 492-4780  
Fax (902) 492-4781  
Email: [info@satlantic.com](mailto:info@satlantic.com)  
Web: [www.satlantic.com](http://www.satlantic.com)

**Copyright © 2008 by Satlantic**

This document contains information proprietary to Satlantic or to a third party to which Satlantic may have legal obligation to protect such information from unauthorized disclosure, use or duplication. Any disclosure, use or duplication of this document, in whole or in part, or of any of the information contained herein for any purpose other than the specific purpose for which it was disclosed is expressly prohibited, except as Satlantic may otherwise agree to in writing.

 <b>Operation Manual</b>	SYSTEM	<b>Profiler II Ocean Profiler</b>
	SECTION	<b>TABLE OF CONTENTS</b>

<b>A - OVERVIEW.....</b>	<b>A-1</b>
PURPOSE.....	A-2
BACKGROUND.....	A-2
FEATURES.....	A-2
ACRONYMS.....	A-3
PROFILER II SYSTEM.....	A-5
PROFILER II MAJOR COMPONENTS.....	A-7
Profiler II Instrument Body.....	A-7
Sensors.....	A-9
Deck Unit.....	A-15
Cables.....	A-17
Power Supply.....	A-17
Computer.....	A-17
SURFACE REFERENCE SYSTEM.....	A-18
Standalone OCR-500 Sensors Reference System.....	A-19
OCR-500 Sensors with Hub Reference System.....	A-20
Standalone HyperOCR Sensor Reference System.....	A-21
<b>B - SAFETY &amp; HAZARDS.....</b>	<b>B-1</b>
PERSONAL SAFETY.....	B-1
INSTRUMENTS.....	B-1
CABLE.....	B-1
CONNECTIONS.....	B-1
TROUBLESHOOTING.....	B-2
RECOVERY.....	B-2
<b>C - START UP.....</b>	<b>C-1</b>
ASSEMBLY PROCEDURE.....	C-1
Preparation.....	C-1
Connect the Components and Cables.....	C-2
Distance Measurements.....	C-4
Mounting the Reference System.....	C-11
Mounting the Reference System.....	C-11
Network Notes.....	C-12
CONDUCTING A TELEMETRY TEST.....	C-13
<b>D - OPERATION.....</b>	<b>D-1</b>
DEPLOYMENT PROCEDURE.....	D-1
Free-Fall Deployment.....	D-1
Multi-Cast Free-Fall Deployment.....	D-3
Frame Mounted Deployment.....	D-4
Conducting a Pressure Tare.....	D-6
Surface Mode Deployment.....	D-7
PROFILER II OPERATING MODES.....	D-9
INITIALIZATION SEQUENCE.....	D-9
AUTONOMOUS OPERATION.....	D-11
NETWORK OPERATION.....	D-12
NETWORK MASTER OPERATION.....	D-13
TELEMETRY FORMAT.....	D-15
<b>E - RECOVERY.....</b>	<b>E-1</b>

 <b>Operation Manual</b>	SYSTEM	<b>Profiler II Ocean Profiler</b>
	SECTION	<b>TABLE OF CONTENTS</b>

<b>F - MAINTENANCE</b> .....	<b>F-1</b>
PREVENTATIVE MAINTENANCE .....	F-1
TROUBLESHOOTING WITH A TERMINAL EMULATOR .....	F-1
TROUBLESHOOTING FOR HARDWARE PROBLEMS .....	F-2
Check Connections .....	F-2
Check the Supply Voltage to the MDU-200 .....	F-2
Check The Output Voltage From The MDU-200.....	F-3
Check Cable Continuity .....	F-4
<b>G - CONFIGURATION</b> .....	<b>G-1</b>
COMMAND CONSOLE .....	G-1
Reset Command .....	G-4
ID Command .....	G-4
Power Command.....	G-4
Set Command .....	G-5
Show Command.....	G-5
Save Command.....	G-7
Ping Command.....	G-7
Remote Command .....	G-8
Query Command .....	G-8
Sample Command.....	G-9
Vout Command .....	G-10
Sd1test and sd2test commands .....	G-10
Exit and Exit! Commands .....	G-10
PROFILER II CONFIGURATION PARAMETERS.....	G-11
Telemetry Baud Rate .....	G-11
Maximum Frame Rate.....	G-11
Initialize Silent Mode .....	G-13
Initialize Power Down .....	G-13
Initialize Automatic Telemetry .....	G-13
Network Mode .....	G-14
Network Address .....	G-14
Network Baud Rate .....	G-15
Network Master Mode .....	G-15
Master Controlled Telemetry .....	G-16
Master Network Bias .....	G-16
Initialize External Power .....	G-17
Foreign Device Headers.....	G-17
Foreign Device Baud Rate .....	G-18
Foreign Device Telemetry Enable .....	G-18
<b>H - WARRANTY</b> .....	<b>G-1</b>
WARRANTY PERIOD.....	G-1
RESTRICTIONS .....	G-1
PROVISIONS.....	G-1
RETURNS.....	G-1
LIABILITY.....	G-1
<b>I - CONTACT INFORMATION</b> .....	<b>I-1</b>
LOCATION .....	I-1
BUSINESS HOURS .....	I-1

 <b>Operation Manual</b>	SYSTEM	<b>Profiler II Ocean Profiler</b>
	SECTION	<b>TABLE OF CONTENTS</b>

**J - MANUAL REVISIONS ..... J-1**

**K - APPENDIX A ..... K-1**

    USING WINDOWS® HYPERTERMINAL ..... K-1

### Index of Figures

Figure A-1: The Profiler II equipped with Hyperspectral Radiometers ..... A-1

Figure A-2: Profiler II System Block Diagram ..... A-4

Figure A-3: Profiler II Major Components ..... A-6

Figure A-4: MCBH-6-M Male Face View ..... A-8

Figure A-5: MCBH-8-F Female Face View ..... A-9

Figure A-6: SatView plot demonstrating Integrated Fluorometer ..... A-10

Figure A -A-7: MCBH-6-F Female Face View ..... A-11

Figure A-8: MDU-200 Deck Unit ..... A-14

Figure A-9: Cables ..... A-16

Figure A-10: A Surface Reference System Field Test ..... A-18

Figure A-11: Standalone OCR-500 Reference Sensors ..... A-19

Figure A-12: Surface Reference Hub System ..... A-20

Figure A-13: Standalone HyperOCR Reference Sensors ..... A-21

Figure C-1: Frame-mounted assembly ..... C-3

Figure C-2: Power/Telemetry Cable Connections ..... C-4

Figure C-3: Sensor Position Measurements: Profiler II with HyperOCRs ..... C-7

Figure C-4: Sensor Position Measurements: Profiler II with HyperOCRs in Surface Mode ..... C-8

Figure C-5: Sensor Position Measurements: Profiler II with OCR-507s ..... C-9

Figure C-6: Sensor Position Measurements: Profiler II with OCR-507 IR ..... C-10

Figure C-7: Reference Sensor Mounting ..... C-11

Figure D-1: Free-Fall Deployment ..... D-2

Figure D-2: Typical multicast regression processing ProSoft 8.0 ..... D-4

Figure D-3: Frame Mounted Deployment ..... D-5

Figure D-4: Pressure Tare in SatView ..... D-7

Figure D-5: Profiler II in Surface Mode ..... D-8

Figure D-6: Float installation for Profiler II Surface Mode ..... D-9

Figure K-1: Add/Remove Programs ..... K-2

Figure K-2 - HyperTerminal Connection Description ..... K-3

Figure K-3 - HyperTerminal Connect To dialog box ..... K-3

Figure K-4 – Serial Port Properties dialog box ..... K-4

Figure K-5 – Connection Properties dialog box ..... K-5

Figure K-6 – ASCII Setup dialog box ..... K-6

 <b>Operation Manual</b>	SYSTEM	<b>Profiler II Ocean Profiler</b>
	SECTION	<b>TABLE OF CONTENTS</b>

### Index of Tables

Table A-1: Optical sensor connector pin designations .....	A-9
Table A-2: Foreign sensor connector pin designations .....	A-11
Table A-3: Currently supported foreign sensors.....	A-12
Table C-1: Factory standard sensor distance settings .....	C-5
Table C-2: Distances to check factory settings .....	C-6
Table C-3: ProSoft 8.0 default distances for factory settings .....	C-6
Table D-1: Optional telemetry control commands, Autonomous Mode.....	D-12
Table D-2: Optional telemetry control commands, Network Master Mode.....	D-15
Table D-3: Profiler II telemetry format .....	D-17



 <b>Operation Manual</b>	SYSTEM <p style="text-align: center;"><b>Profiler II Ocean Profiler</b></p>
	SECTION <p style="text-align: center;"><b>A - OVERVIEW</b></p>

**A - OVERVIEW**



**Temperature-Only Configuration**

*Figure A-1: The Profiler II equipped with Hyperspectral Radiometers*

	SYSTEM	<b>Profiler II Ocean Profiler</b>
	SECTION	<b>A - OVERVIEW</b>

## ***Purpose***

The Profiler II design builds on the experience gained by Satlantic on previous generations of profiling instruments. It offers researchers the unique opportunity to use the system as a free-fall profiling device or in conjunction with a detachable float for near-surface measurements. The system is also available mounted on a lowering frame.

The Profiler II is specifically designed to allow the interchangeable use of Satlantic's high-resolution multispectral OCR-500 series optical sensors and hyperspectral HyperOCR (or OCR-3000) sensors<sup>1</sup>. Optional features include a conductivity sensor and integration of up to two non-Satlantic instruments into the instrument package, making this system the most versatile platform for measuring the apparent optical properties of the ocean. The system addresses the issues of self-shadowing and ship induced disturbances while offering a wide dynamic range in an easy to deploy package.

## ***Background***

The Profiler II is Satlantic's next-generation profiling instrument, building upon the very successful MicroPro design. The primary goal of this design was to allow data to be collected with a high spatial resolution in the regions around a field station on a typical oceanographic cruise. A secondary goal for the instrument was to support experiments in the case-2 waters that are often found in the near-shore and littoral environments. Water conditions in these areas are such that light levels below 100 meters depth (generally below six optical depths) are extremely low, difficult to measure, and provide little significant information in terms of the satellite validation mission being performed. In addition, attenuation levels are high enough that it becomes important to have downwelling irradiance and upwelling radiance sensors located close to the same depth.

The Profiler II design builds on the experience gained by Satlantic on previous generations of profiling instruments. Designing the Profiler II with the capability to operate in both free-fall and at-surface modes, the ability to interchange hyperspectral and multispectral sensors, and the seamless integration of two foreign sensors such as a fluorometer and backscatter meters, has resulted in an outstanding instrument package.

## ***Features***

- Operates in both surface and free-fall modes
- Optional lowering frame package available
- Small, lightweight and easily deployed
- Interchangeable, networked Satlantic optical sensors
- Easy integration of non-Satlantic instruments
- Minimal amount of surface equipment required
- Easy to use

<sup>1</sup> A Profiler II configured with HyperOCR or OCR-3000 (MiniSpec) sensors is commonly referred to as a "HyperPro II." Satlantic developed the HyperOCR, for Hyperspectral Ocean Color Radiometer, with improved electronics to supersede the OCR-3000.

 <p><b>Operation Manual</b></p>	SYSTEM	<b>Profiler II Ocean Profiler</b>
	SECTION	<b>A - OVERVIEW</b>

### **Acronyms**

FOV	Field of View
HyperOCR	Hyperspectral Ocean Color Radiometer
OCR 3000	Hyperspectral radiometer, superceded by HyperOCR.
ICSW	Irradiance Cosine in Water (Ed, Eu)
ICSA	Irradiance Cosine in Air (Es)
R10W	Radiance 10 degree ½ angle field of view in Water (Lu)
R08W	Radiance 8 degree ½ angle field of view in Water (Lu, Ls)
R03A	Radiance 3 degree ½ angle field of view in Air (Li, Lt)
IR	Combination Irradiance and Radiance radiometer model which integrates an ICSW and a R10W 500 series multispectral sensor in one instrument for the PROII.
UV	Ultra Violet (305, 325, 340, 380 channels available in multispectral radiometers)
MDU-200	Micro Deck Unit. -100, -200, -300, -400 denote various voltage/power models convert 12 VDC battery power to 48-72 VDC profiler supply.
PROII	Second generation profiler body, also known as Profiler II
CT	Conductivity and temperature sensor
Ed	Downwelled irradiance
Es	Surface irradiance
Eu	Upwelled irradiance
Lu	Upwelled radiance

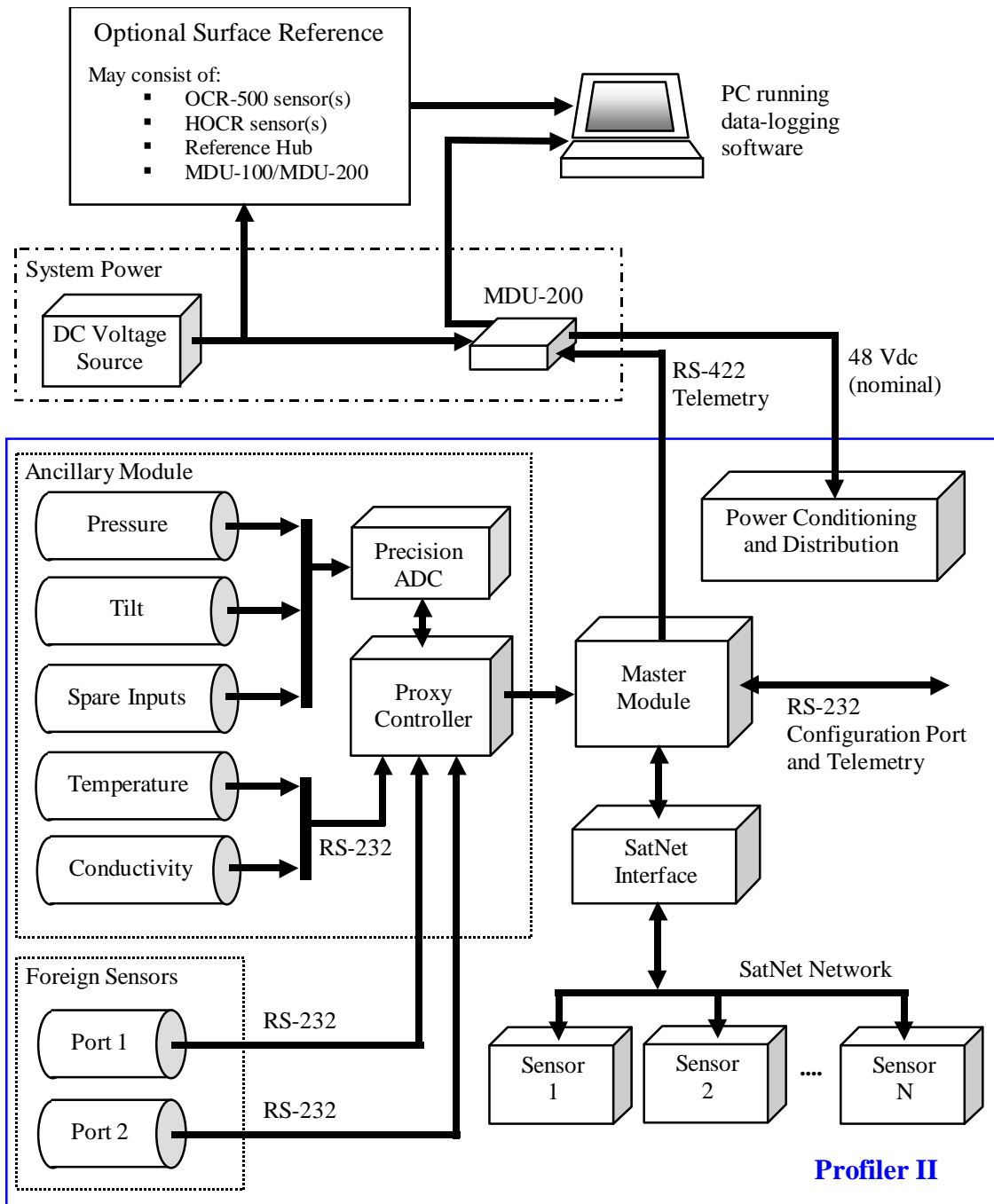



Figure A-2: Profiler II System Block Diagram

	SYSTEM	<b>Profiler II Ocean Profiler</b>
	SECTION	<b>A - OVERVIEW</b>

## ***Profiler II System***

The Profiler II system can be viewed as a grouping of modules. This modular design greatly increases the system's versatility and re-configuration potential. The basic modules are the system power module, the master module, the ancillary module and the optical sensor slave modules.

See Figure A-2: Profiler II System Block Diagram

The system power module is comprised of a 12 Volt (nominal) DC power supply, usually a battery, and Satlantic's MDU-200 deck unit. Another deck unit with the same capabilities as the MDU-200 may be used. The DC power supply delivers a voltage in the range of 10 - 20 V dc to the MDU-200 deck unit where it is converted to 48 V and sent through the power/telemetry cable to power the Profiler II. The deck unit also converts RS-422 telemetry from the Profiler II to RS-232 levels so that it can be sent to the computer.

The main housing of the Profiler II body contains the master module and the ancillary module, as well as an internal power conditioning and distribution system. The master module is essentially a microcontroller board that controls the ancillary module and communicates with the slave devices (usually OCR-500 or HyperOCR series instruments) via the SatNet interface. The master module's responsibilities include (but are not limited to):

- Coordinating bus access
- Issuing sample commands to the slave modules (when required)
- Retrieving data from the slave modules
- Broadcasting the data frames on the serial up-link

In most systems, the master device coordinates bus access but otherwise allows the slave devices to free-run, transmitting data as it becomes available.

The ancillary slave module is also a microcontroller system (the *proxy* controller) in the main housing of the Profiler II body. The proxy controller normally obtains measurements from the pressure, tilt, temperature and conductivity sensors, with spare channels available for future integration of additional sensors. The proxy also has the capability of obtaining RS-232 data from two foreign (non-Satlantic) instruments. The proxy controller operates as a slave device, and responds only to commands from the master module to obtain data from its sensors. Analog measurements with the ancillary module are made using an 8-channel precision 16-bit Analog-to-Digital Converter (ADC).

On a typical system, one to four optical sensor slave modules are attached to the Profiler II body outside of the main housing. These slave modules obtain and report data to the master module. An optional independent surface reference system can be included – please refer to the *Surface Reference System* section for details.

 <b>Operation Manual</b>	SYSTEM	<b>Profiler II Ocean Profiler</b>
	SECTION	<b>A - OVERVIEW</b>

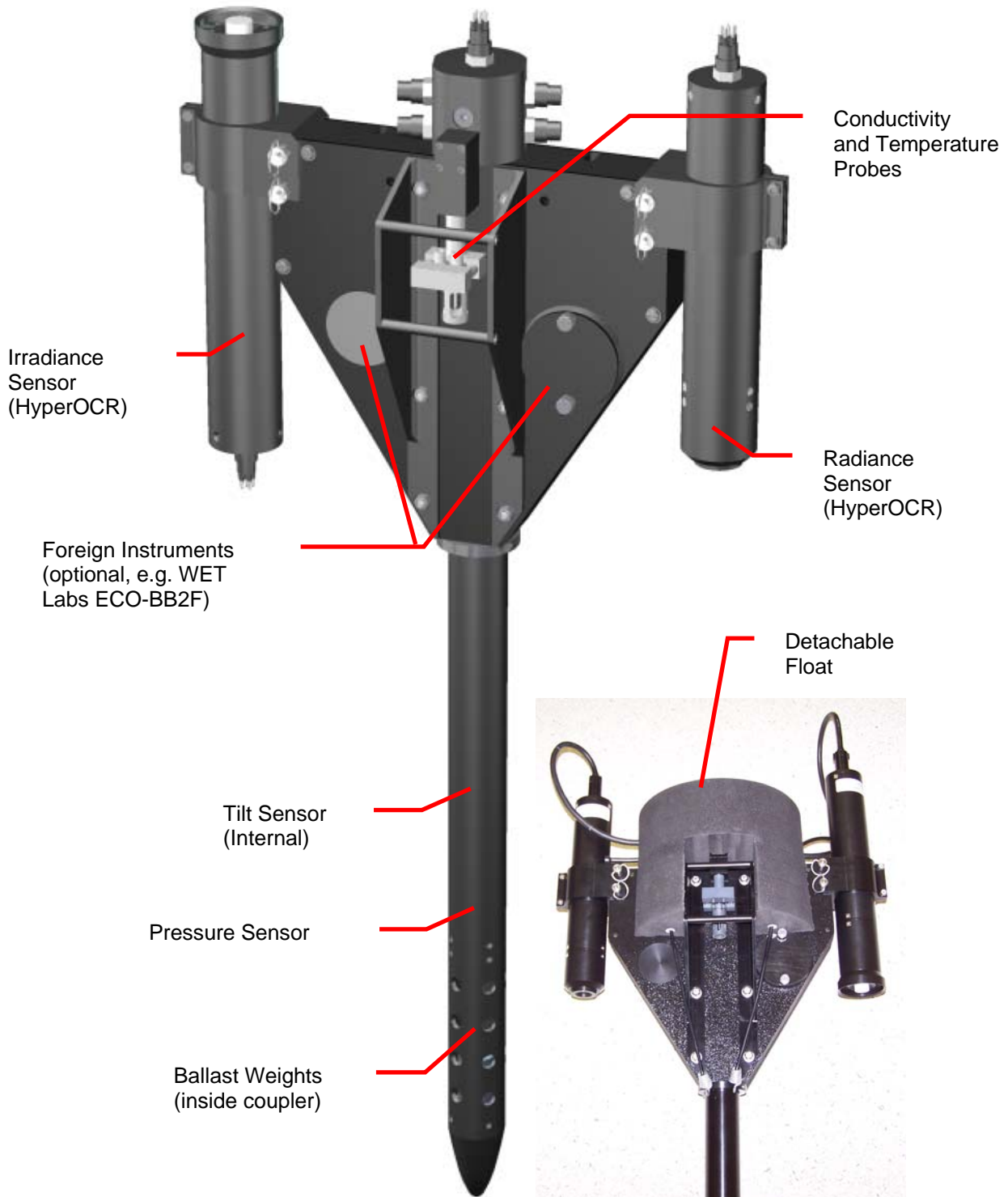



Figure A-3: Profiler II Major Components

	SYSTEM	<b>Profiler II Ocean Profiler</b>
	SECTION	<b>A - OVERVIEW</b>

## ***Profiler II Major Components***

The major components of the Profiler II are the instrument body, sensors, deck unit, cables, power supply (typically a 12 Volt battery) and computer. Normally the computer and power supply are supplied by the user.

### **PROFILER II INSTRUMENT BODY**

The modular design of the Profiler II allows the system to be configured in a number of ways. Currently, the system can be configured by Satlantic to be either a free-falling profiler with detachable float for near-surface measurements, or mounted on a lowering frame. Surface reference and SAS configurations are also available.

*See Figure A-3: Profiler II Major Components*

### **Free-Fall Profiler**

The Profiler II *free-fall* profiling design builds on the experience Satlantic gained in earlier generations of profiling instruments. The primary advantage of this deployment technique is that it provides a straightforward method of making measurements away from the ship being used to deploy the instrument and away from the measurement errors that its shadows create. With a main pressure-housing diameter of only 48 mm and a weight of about 8.2 kg (with two HyperOCR sensors attached), this new design minimizes the size and weight of the profiler, allowing rapid deployment from even small inflatable boats. The free-fall descent rate of the instrument is user-adjustable from 0.1 m/sec to 1.0 m/sec (typical) through the use of lead ballast, with 0.1 to 0.3 m/sec recommended for case-II waters. The ballast is located within the flooded coupler and can be easily adjusted by the user by removing the parabolic nose cone and adding or removing weight as required. The lead weights are attached using a threaded brass rod, such that galvanic corrosion should occur to the lead weights before the brass. Descent rate can be fine-tuned using metal (brass) washers.

The removable flotation collar (see insert photo) is easily mounted to the profiler for real time, near-surface measurements. Upwelling radiance and irradiance measurements can be collected as close as 5 cm from the sea surface.

	SYSTEM	<b>Profiler II Ocean Profiler</b>
	SECTION	<b>A - OVERVIEW</b>

### **Frame Mounted Profiler**

Configuring the Profiler II for use on Satlantic's rugged stainless steel or aluminum lowering frame allows the irradiance and radiance sensors to be mounted in the same plane. This is an ideal situation in waters with high attenuation levels. In addition, the frame configuration allows the user to suspend the Profiler II at a particular depth without concern for the vertical stability of the instrument, as in the case for the free-fall profiler.

### **Power/Telemetry Cable Connection**

The instrument body is connected to the power/telemetry cable through an electrical connector, as shown in the figure below. There is also a mechanical connection between the instrument body and the power/telemetry cable to allow the Profiler II to be deployed and recovered without straining the electrical connection.

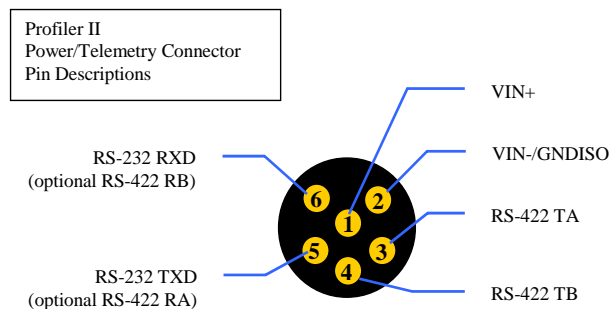

*Figure A-4: MCBH-6-M Male Face View*



 <b>Operation Manual</b>	SYSTEM	<b>Profiler II Ocean Profiler</b>
	SECTION	<b>A - OVERVIEW</b>

## SENSORS

Specifications for any of the Profiler II sensors may be obtained by contacting Satlantic. A brief description of each sensor is provided below.

### Optical Sensors

The multispectral OCR-500 and hyperspectral HyperOCR series of digital optical sensors are configured as slave modules for use in the Profiler II system. The sensors are connected to the instrument body through the 8-pin female connector shown below. Please refer to the appropriate instrument series user manual for more details on the optical sensors.

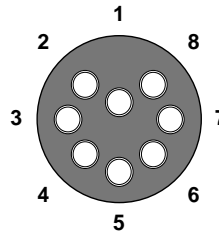

*Figure A-5: MCBH-8-F Female Face View*

These pins are designated as follows:

Pin	Identification	Description
1	V+	Sensor Power (12 Volts).
2	V-/SG	Power Supply Return / Signal Ground.
3	N/C	Not internally connected.
4	N/C	Not internally connected.
5	N/C	Not internally connected.
6	N/C	Not internally connected.
7	NA	RS-485 SatNet Network Interface (A)
8	NB	RS-485 SatNet Network Interface (B)

*Table A-1: Optical sensor connector pin designations*



 <b>Operation Manual</b>	SYSTEM <p style="text-align: center;"><b>Profiler II Ocean Profiler</b></p>
	SECTION <p style="text-align: center;"><b>A - OVERVIEW</b></p>



Figure A-6: SatView plot demonstrating Integrated Fluorometer

	SYSTEM	<b>Profiler II Ocean Profiler</b>
	SECTION	<b>A - OVERVIEW</b>

### **Foreign (non-Satlantic) Sensors**

The Profiler II accepts telemetry from up to two foreign instruments and retransmits this telemetry to the surface. The foreign instruments connect to the Profiler II through the two 6-pin female bulkhead connectors, detailed below. These bulkhead connectors are referred to as “Port 1” and “Port 2”. Data from these devices can be displayed and logged by SatView.

See Figure A-6: SatView plot demonstrating Integrated Fluorometer

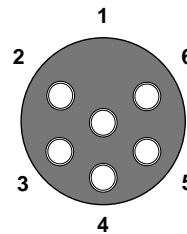

Figure A -A-7: MCBH-6-F Female Face View

The pins are designated as follows:

Pin	Identification	Description
1	V-/SG	Power Supply Return / Signal Ground.
2	TXD	RS-232 Data <i>TO</i> foreign sensor
3	N/C	Not internally connected.
4	V+	Sensor Power (12 Volts).
5	RXD	RS-232 Data <i>FROM</i> foreign sensor
6	N/C	Not internally connected.

Table A-2: Foreign sensor connector pin designations

### Restrictions On Foreign Sensors

While the Profiler II is very flexible in the type of foreign sensors that can be integrated, there are some restrictions on the devices. These restrictions are:

1. RS-232 telemetry only, using 8 data bits, 1 start and stop bit, and no parity or flow control. However, the profiler firmware could be customized if required.
2. Data must be in ASCII format, with the data being line-feed terminated and complete frames being 128 bytes or less in size.
3. Operate at a standard baud rates in the range 2400 to 115200 bps (see the

 <b>Operation Manual</b>	SYSTEM <p style="text-align: center;"><b>Profiler II Ocean Profiler</b></p>
	SECTION <p style="text-align: center;"><b>A - OVERVIEW</b></p>

Foreign Device Baud Rate section for details.

4. The device must accept a 12 V power supply. Available current depends on system configuration (power/telemetry cable length, etc) but several hundred milliamps are available.
5. Device frame rate (update rate) should be 10 Hz or less.
6. Only small devices (e.g. WET Labs ECO series) will integrate properly with the free-fall system. Larger devices should be used with a lowering frame.

### Currently Supported Devices

A common request from Satlantic customers is the integration of non-Satlantic instrumentation into profiling systems to complement the optical measurements. In response, Satlantic has collaborated with WET Labs Inc. to seamlessly integrate many of the ECO series instruments. A custom mechanical configuration of the ECO Puck™ was developed (designated –SAT) to mount *within* the Profiler II fins. Plastic ballast dummies ensure proper buoyancy and balance when the devices are not present.

The most common option is the WET Labs ECO-BB2F-SAT combination backscatter meter and fluorometer. The following WET Labs instruments are available for integration:

Device	Description
ECO-BB-SAT	Single-angle scattering meter
ECO-BB2F-SAT	Combination scattering meter and fluorometer
ECO-BB3-SAT	Three-wavelength scattering meter
ECO-FL-SAT	Chlorophyll fluorometer
ECO-FL-NTU-SAT	Combination chlorophyll fluorometer and turbidity sensor
ECO-VSF-SAT	Three-angle backscattering meter

*Table A-3: Currently supported foreign sensors*

A plastic guard ring helps protect the sensor’s optical window from scratches during deployment. A plastic cover plate attaches with thumbscrews to the ring to protect the window during storage.

 <b>Operation Manual</b>	SYSTEM	<b>Profiler II Ocean Profiler</b>
	SECTION	<b>A - OVERVIEW</b>

### **Pressure Sensor<sup>2</sup>**

The Profiler II is equipped with a precision Druck PMP 4000 series pressure sensor that provides an analog signal to the ancillary module's ADC. This pressure sensor provides accurate depth data (0.04% full-scale typical). The pressure sensor is available in a variety of pressure ranges and may be chosen to match the application, with 0 - 300 psi being the standard offering, allowing 0.1 m accuracy and 0.01 m precision.

### **Tilt Sensor<sup>2</sup>**

The Profiler II is equipped with a miniature biaxial clinometer (tilt sensor). This sensor provides an analog voltage representation to the ancillary module's ADC for tilt measurements in two axes (X and Y axes or pitch and roll). This sensor provides a linear operating range of  $\pm 25^\circ$ , with an accuracy of  $0.2^\circ$ .

### **Thermal Probe<sup>2</sup>**

The Profiler II is equipped with an external thermal probe to determine the water temperature  $T_w$ . There are two options for the temperature sensor: temperature or temperature and conductivity.

If equipped for temperature-only, the thermistor is thermally calibrated and provides 0.020 °C accuracy and 0.003 °C precision over an operating range of -2.5 °C to +40 °C.

In the combined conductivity and temperature sensor configuration, the thermistor is thermally calibrated and provides  $\pm 0.005^\circ\text{C}$  accuracy and 0.001 °C precision over an operating range of -2 °C to +40 °C.

### **Conductivity Probe<sup>2</sup>**

The Profiler II is available with an external, platinized, four-electrode, conductivity sensor that is integrated with the thermal probe. The analog signal from the probe is digitized and converted to a calibrated value with an OEM electronics module. It operates over a typical range of 0 mmho/cm to 70 mmho/cm, with an accuracy of 0.01 mmho/cm and a precision of 0.0015 mmho/cm.

<sup>2</sup> Specifications subject to change without notice.

	SYSTEM	<b>Profiler II Ocean Profiler</b>
	SECTION	<b>A - OVERVIEW</b>

MDU-200 Deck Unit Power Supply

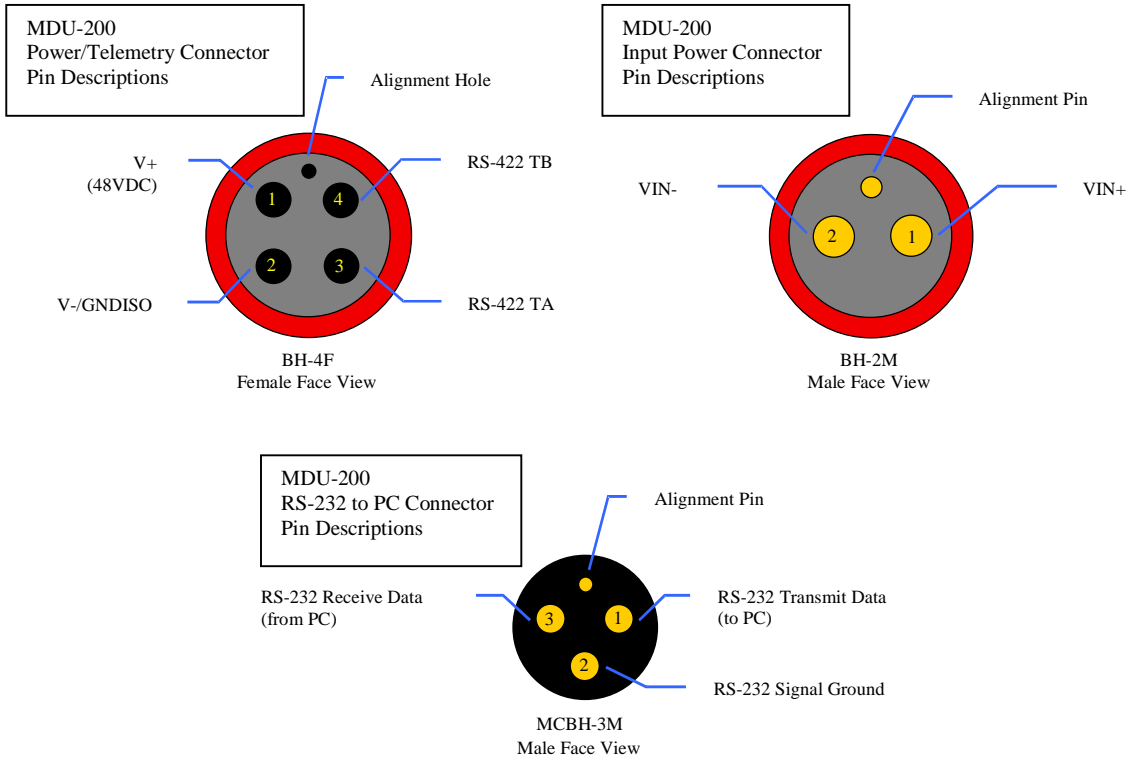



Figure A-8: MDU-200 Deck Unit

 <b>Operation Manual</b>	SYSTEM	<b>Profiler II Ocean Profiler</b>
	SECTION	<b>A - OVERVIEW</b>

### **DECK UNIT**

The MDU-200 deck unit serves as both a nominal 48 Volt DC power source for the Profiler II system and as a RS-422 to RS-232 level converter. The MDU-200 is capable of providing up to 75 Watts of power. The MDU-200 is connected to the battery, the instrument body and the computer, through three connectors. Connector details are shown in the figure.

*See Figure A-8: MDU-200 Deck Unit*

A design goal for the Profiler II was low-power operation. Although power requirements vary with system configuration, a typical system with two HyperOCR sensors and an integrated WET Labs ECO-BB2F (combination backscatter meter and fluorometer) has a steady-state power requirement of approximately 12 Watts. Assuming a pessimistic 75% conversion efficiency for the MDU-200, this system would require about 1.3 Amps from a 12 V battery. Using a large rechargeable 12 V battery, such as a 50 amp-hour gel-cell, will provide many hours of operation and will have sufficient power to run a laptop as well.

 <b>Operation Manual</b>	SYSTEM	<b>Profiler II Ocean Profiler</b>
	SECTION	<b>A - OVERVIEW</b>

RS-232 Cable  
(To PC)

Power/Telemetry Cable  
(To Profiler II)



Supply Cable

MDU-200

12 V Battery

*Figure A-9: Cables*



	SYSTEM	<b>Profiler II Ocean Profiler</b>
	SECTION	<b>A - OVERVIEW</b>

## CABLES

The **Power/telemetry cable** runs from the deck unit to the instrument body.

*See Figure A-9: Cables*

The power/telemetry cable acts as a mechanical and electrical tether, providing a flexible, high strength connection between the vessel and the instrument and providing a channel to transport telemetry to the deck unit. The cable weighs approximately 700g/100m in water. The mechanical terminations can withstand 750 kg of tension and prevent electrical termination damage and instrument loss.

The **Supply Cable** or Battery Cable runs from the battery to the deck unit.

The **RS-232 Cable** runs from the deck unit to the computer.

The **Interconnect Cables**, typically one for each sensor depending on the system, connect sensors to the main housing on instrument body.

## POWER SUPPLY

The power supply is normally a battery, but may be any DC power supply in the range of 10-20 volts at 2 Amps (current requirements depend on system configuration). However, in a battery-powered system we recommend using a fairly large battery (i.e. 50 Ah gel cell). This allows a laptop computer to use the same power supply as the Profiler II.

## COMPUTER

The user must supply a computer in order to view and log Profiler II telemetry. SatView, Satlantic's data logging and display program, will operate on any IBM compatible computer running Microsoft Windows with at least 5 MB of free disk space and a free RS-232 serial port (additional ports are required for reference instruments). Additional disk space is required to log data from the Profiler II; allow several Megabytes. Please refer to the SatView manual for more details.

 <b>Operation Manual</b>	SYSTEM	<b>Profiler II Ocean Profiler</b>
	SECTION	<b>A - OVERVIEW</b>

### ***Surface Reference System***

The Profiler II Surface Reference system is used to provide downwelling irradiance data during profiler casts. Normally, the reference is mounted high on the research vessel to avoid shading from the superstructure.

There are two basic configurations for the reference system – standalone OCR-500 or HyperOCR sensors, or two (or more) OCR-500 or HyperOCR sensors connected to a reference hub device. The following sections detail each configuration.



*Figure A-10: A Surface Reference System Field Test*

 <b>Operation Manual</b>	SYSTEM	<b>Profiler II Ocean Profiler</b>
	SECTION	<b>A - OVERVIEW</b>

### STANDALONE OCR-500 SENSORS REFERENCE SYSTEM

In this system, individual OCR-507-ICSA sensors are used to provide the reference data. The number of reference sensors used will depend on the user requirements; a typical system uses two OCR-507-ICSA sensors.

In this configuration, RS-232 or RS-422 data is provided directly to the logging computer. The reference sensors can operate directly from the main (+12 V) battery. The disadvantage of this system is that each reference sensor requires its own communication port. If your logging computer does not have a sufficient number of available communication ports, PCMCIA cards can be purchased to provide additional ports. However, there are some circumstances that require a hub system.

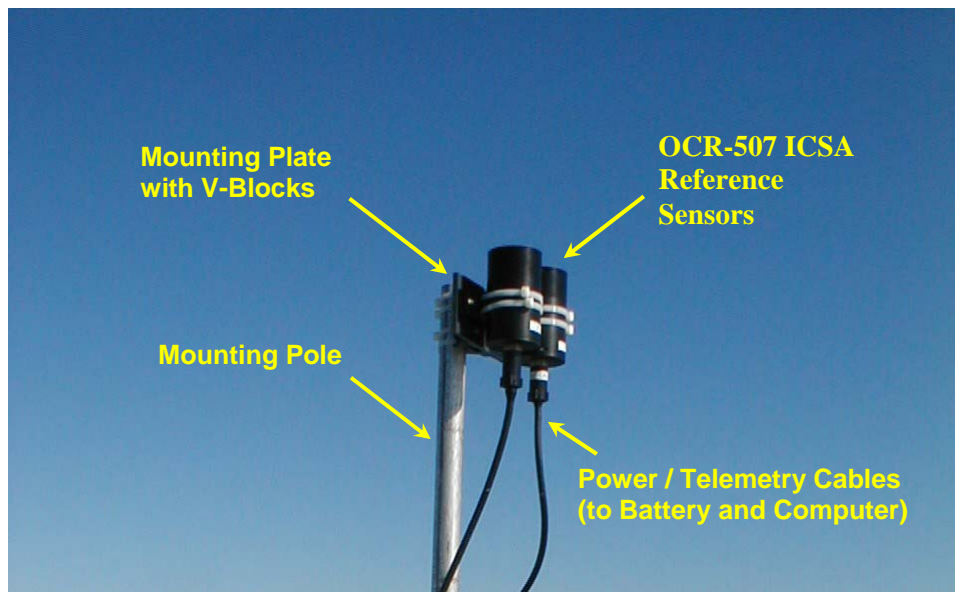

*Figure A-11: Standalone OCR-500 Reference Sensors*

For complete details on the use of the OCR-500 reference sensor, please refer to the appropriate instrument operation manual.

 <b>Operation Manual</b>	SYSTEM	<b>Profiler II Ocean Profiler</b>
	SECTION	<b>A - OVERVIEW</b>

### OCR-500 SENSORS WITH HUB REFERENCE SYSTEM

This configuration is essentially a MicroPro or Profiler II that is used out of the water. It offers the advantage of merging all of the reference sensor data into a single telemetry stream, although system cost is increased.

The same modules that make up the profiler are used in the reference hub. However, the pressure and temperature sensors are not included in this configuration, shortening the overall hub body length. Tilt/pitch-and-roll sensors are available as an option. Normally, an MDU-100 or MDU-200 is used to power the reference hub, although it is possible to configure the hub for 12 VDC operation.

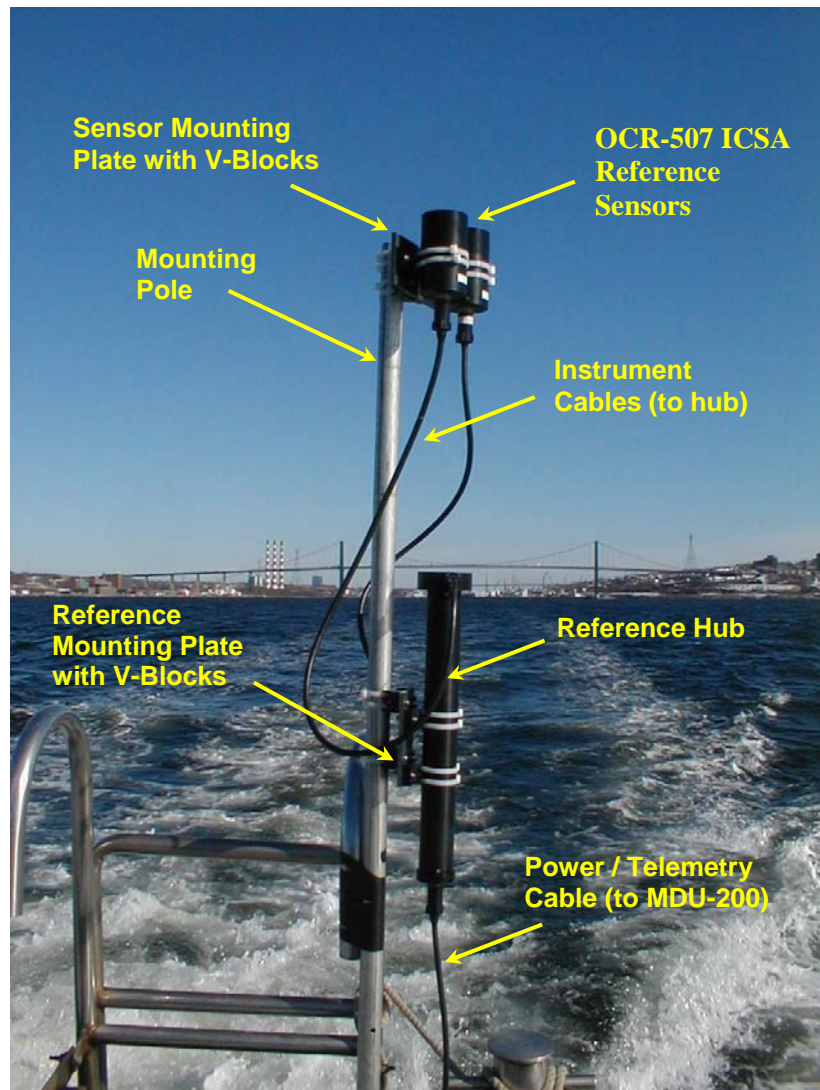



Figure A-12: Surface Reference Hub System

 <b>Operation Manual</b>	SYSTEM	<b>Profiler II Ocean Profiler</b>
	SECTION	<b>A - OVERVIEW</b>

### STANDALONE HYPEROCR SENSOR REFERENCE SYSTEM

In this system, an individual HyperOCR sensor is used to provide the reference data. It is also an option to add a hub to the reference that adds tilt information. A HyperSAS is another option for a reference.

In this configuration, RS-232 or RS-422 data is provided directly to the logging computer. A reference sensor can be configured to operate directly from the main (+12 V) battery or an MDU-200, depending on the user's requirements. The disadvantage of this system is that each reference sensor requires its own communication port. If your logging computer does not have a sufficient number of available communication ports, PCMCIA cards can be purchased to provide additional ports.

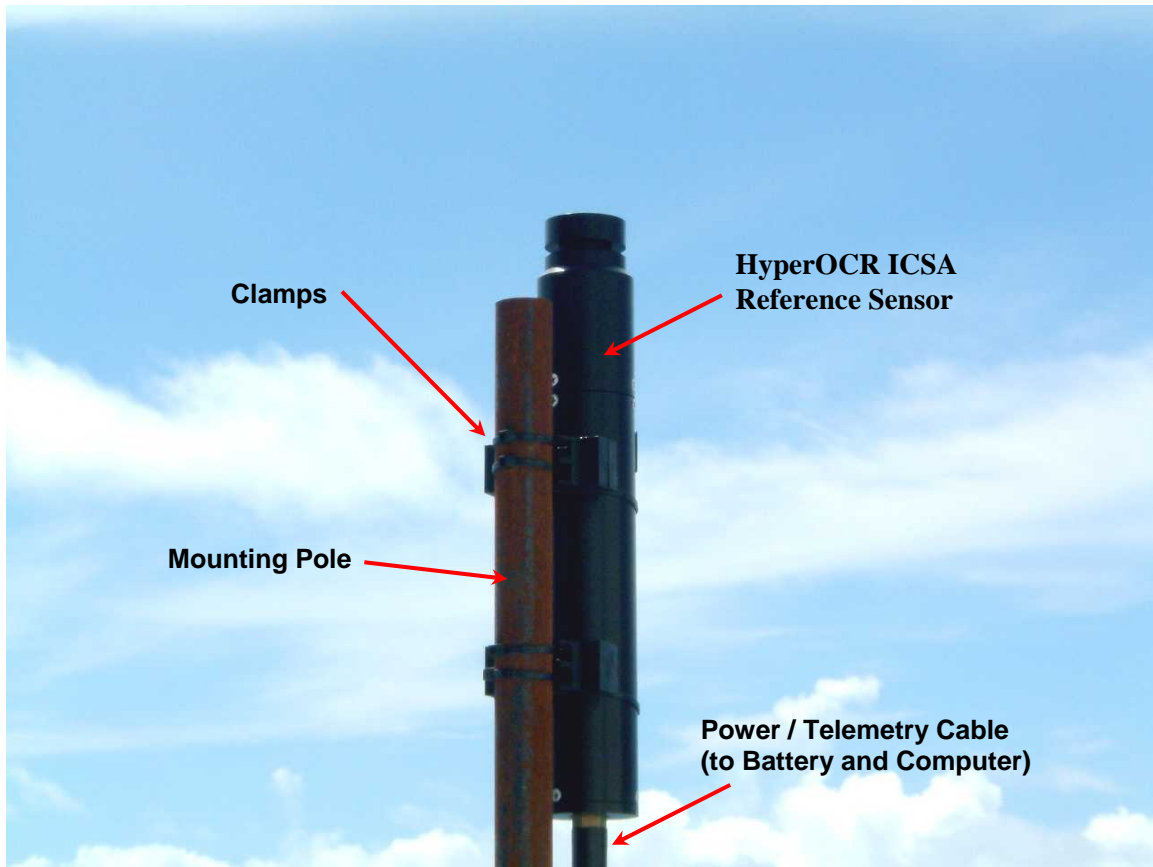

*Figure A-13: Standalone HyperOCR Reference Sensors*

For complete details on the use of the HyperOCR reference sensor, please refer to the instrument operation manual.

 <p>Operation Manual</p>	SYSTEM	<b>Profiler II Ocean Profiler</b>
	SECTION	<b>B – SAFETY &amp; HAZARDS</b>

## **B - SAFETY & HAZARDS**

### ***Personal Safety***

- The operators should always remain aware of the cable. Any cable or line released from a ship can be dangerous. Keep a safe distance from the cable coil on deck when the instruments are being used.

### ***Instruments***

- Do not leave instruments in direct sunlight when not in use. Direct sunlight can easily increase the internal temperature of the instrument beyond its maximum rating.
- Do not leave an in-water instrument unattended. Boat drift can entangle the cable and cause damage or instrument loss.

### ***Cable***

- To prevent damage to the conductors within the Kevlar™ strength member, ensure the power/telemetry cable is not pinched or bent to a radius less than 18 cm.

### ***Connections***

- Handle electrical terminations carefully, as they are not designed to withstand strain. Disconnect the cables from the components by pulling on the connector heads and not the cables. Do not twist the connector while pulling, as this will damage the connector pins.
- Do not use petroleum-based lubricants on connectors. Connectors should be free of dirt and lightly lubricated before mating. Satlantic recommends using DC-111 silicone grease (made by Dow-Corning®) on the male pins prior to connection.

 <b>Operation Manual</b>	SYSTEM	<b>Profiler II Ocean Profiler</b>
	SECTION	<b>B – SAFETY &amp; HAZARDS</b>

### ***Troubleshooting***

- While checking voltages with a multimeter, extreme care should be used to not short the probe leads. A shorted power supply or battery can output many amperes of current, potentially harming the user, starting fires, or damaging equipment.

### ***Recovery***

- Remember never to grab the electrical portion of the instrument cable during recovery. This can cause damage to the power/telemetry bulkhead and the underwater splice.
- Lens caps should always be replaced as soon as the instrument comes back on board. This will help protect the heads from direct damage.
- Be sure to rinse seawater from the instrument with fresh water prior to storage. Corrosion resulting from failure to do so is not covered under warranty.

	SYSTEM	<b>Profiler II Ocean Profiler</b>
	SECTION	<b>C – START UP</b>

## C - START UP

### *Assembly Procedure*

#### PREPARATION

The Profiler II Ocean Profiler is a simple instrument to set up and operate. The instrument is normally operated as a stand-alone device, but it could be configured for operation in a networked environment as part of a larger system. Generally, requirements for operation are the same for both of these operating modes, although a networked environment may impose additional requirements. You will need the following items:

- DC power source (10–20 VDC for the MDU-200, normally a 12 V battery).
- Computer with a free serial communications port for telemetry acquisition.
- Data acquisition and processing software compliant with the *Satlantic Data Format Standard*.
- The instruments *calibration files*<sup>3</sup> (provided), normally packaged as a *Satlantic Instrument Package* (.SIP) file for ease of use with SatView.

If you are not using your instrument in an embedded system, or you do not have your own data acquisition software, you may use the software provided by Satlantic. Two applications<sup>4</sup>, *SatView* and *SatCon*, are available to you for any PC running Windows<sup>®</sup><sup>5</sup> 95/98/NT/2000/XP/Vista. Both applications are compliant with the Satlantic Data Format Standard. *SatView* is a data acquisition and real-time display application. *SatCon* is a post processing application for telemetry logged by *SatView*. ProSoft, Satlantic's analytical software, is also available on request, and can be used to derive information such as water-leaving radiance, diffuse attenuation coefficients, and photosynthetically available radiation (PAR).

Note that it is not necessary to use the software mentioned above to log the instrument telemetry. A properly configured terminal emulator can serve this purpose. However, you will need the proper software to interpret any of the data.

In any case, there are a few standard communications settings needed for any computer application communicating with the instrument. All serial transmissions use 1 start bit, 8 data bits, 1 stop bit, and no parity. No flow control of any kind is used. Make sure that your software is configured with the baud rate specified for your instrument. These settings apply to both the RS-232 and RS-422 telemetry interfaces. For most applications, the default telemetry baud rate is 57600 bps.

<sup>3</sup> For more information on calibration files, refer to the *Instrument File Standard* document available from Satlantic

<sup>4</sup> For more information on these applications, refer to the user manuals distributed with the software.

<sup>5</sup> Windows is a registered trademark of Microsoft Corporation.



 <b>Operation Manual</b>	SYSTEM	<b>Profiler II Ocean Profiler</b>
	SECTION	<b>C – START UP</b>

**IMPORTANT! Both the RS-232 and RS-422 telemetry interfaces transmit the same information. The RS-232 interface provides bi-directional communication while the RS-422 is transmit-only. Normally, the RS-232 interface is used for configuring and testing your instrument. The RS-422 interface would normally be used for telemetry acquisition in the field using longer cables, such as that found with the Profiler II. Most computer serial interfaces are RS-232. The MDU-200 deck unit provides the necessary level conversion.**

In preparation for assembly, the Profiler II components should be checked with the packing list to ensure that all required items are included. There may be additional interconnect cables, weights and other supplies packed with the instrument. The dummy connectors and the optical sensor protective vinyl caps should be removed and stored so that they can be replaced after the instrument is recovered. The instrument packing should be retained and reused to prevent instrument damage during transport.

### **CONNECT THE COMPONENTS AND CABLES**

When making connections, proper alignment on the connector pins is critical to avoid damage. Connectors should be inspected to ensure they are free of dirt and then lightly lubricated before making connections. Visually ensure that the pins on the male connectors are properly aligned with (and partially seated into) the sockets on their female counterparts before pushing them together for final connection. Finally, ensure that the locking sleeve or locking strap is securely fastened after connection.

Connect the instrument body, the computer and the battery to the deck unit, as follows.

1. Mount any sensors to the instrument that are not already in place. If the Profiler II is not already fully assembled, usually only the optical sensors require mounting. For the free-falling configuration, the sensors are attached with positive locking quick release pins. Ensure that the free-fall profiler fins are mounted tight up against the top connector end-cap. If the fins slip on the profiler body, then the depths indicated for the radiometric measurements will be inaccurate. Before and after each profile, check that the instruments and fins are firmly positioned on the profiler. For the frame-mounted instrument, the optical sensors and instrument body are secured by split collet clamps. Similarly, the instruments must be firmly positioned in the split collet clamps throughout the profiler.

*See Figure C-1: Frame-mounted assembly*

The mounting frame you receive may not be exactly as shown. The alignment arrows must match as shown below in order for the pitch and roll (tilt) measurements to be accurate.

	SYSTEM	<b>Profiler II Ocean Profiler</b>
	SECTION	<b>C – START UP</b>

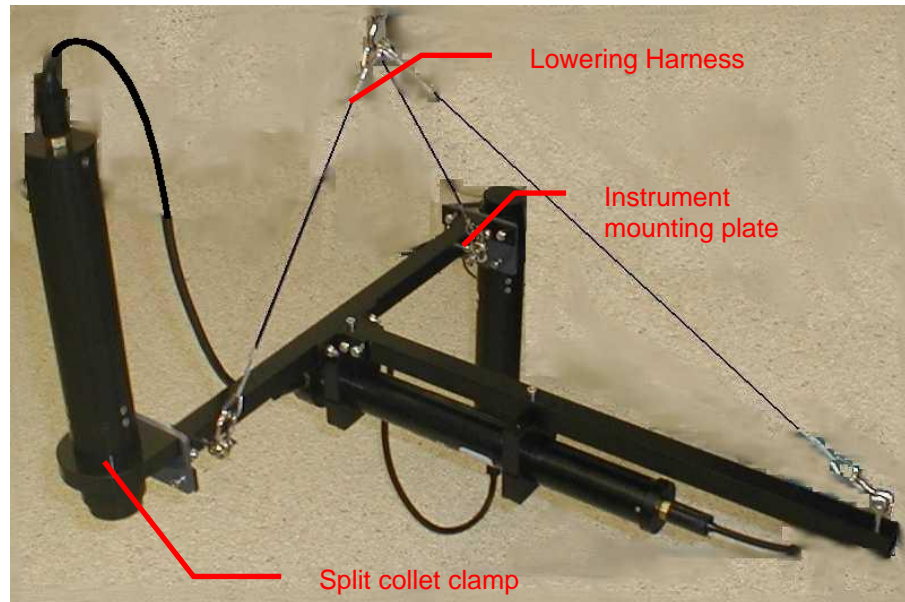
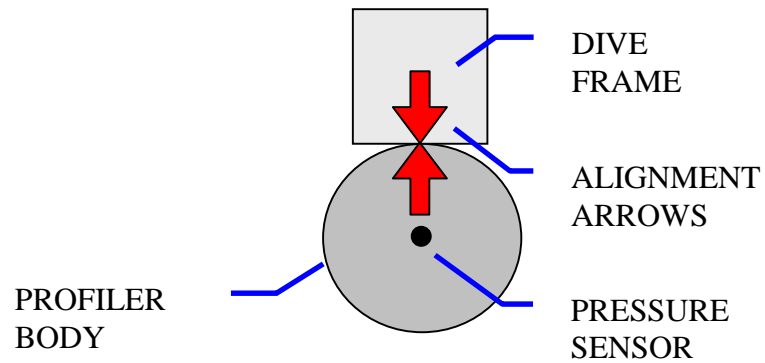

*Figure C-1: Frame-mounted assembly*

2. Connect the sensor cables on the instrument. Ensure that the connectors match before attempting to connect them.
3. Connect the power/telemetry cable to the instrument. First connect the cable shackle to the instrument shackle and then connect the six pin electrical termination to the instrument. The shackle on the other end of the power/telemetry cable may then be connected to a hard attachment point on the vessel.

*See Figure C-2: Power/Telemetry Cable Connections*

4. Connect the power/telemetry cable to the deck unit.
5. Connect the RS-232 cable to the deck unit and computer.

 <b>Operation Manual</b>	SYSTEM	<b>Profiler II Ocean Profiler</b>
	SECTION	<b>C – START UP</b>

6. Connect the deck unit to the battery.
7. Turn on the computer.

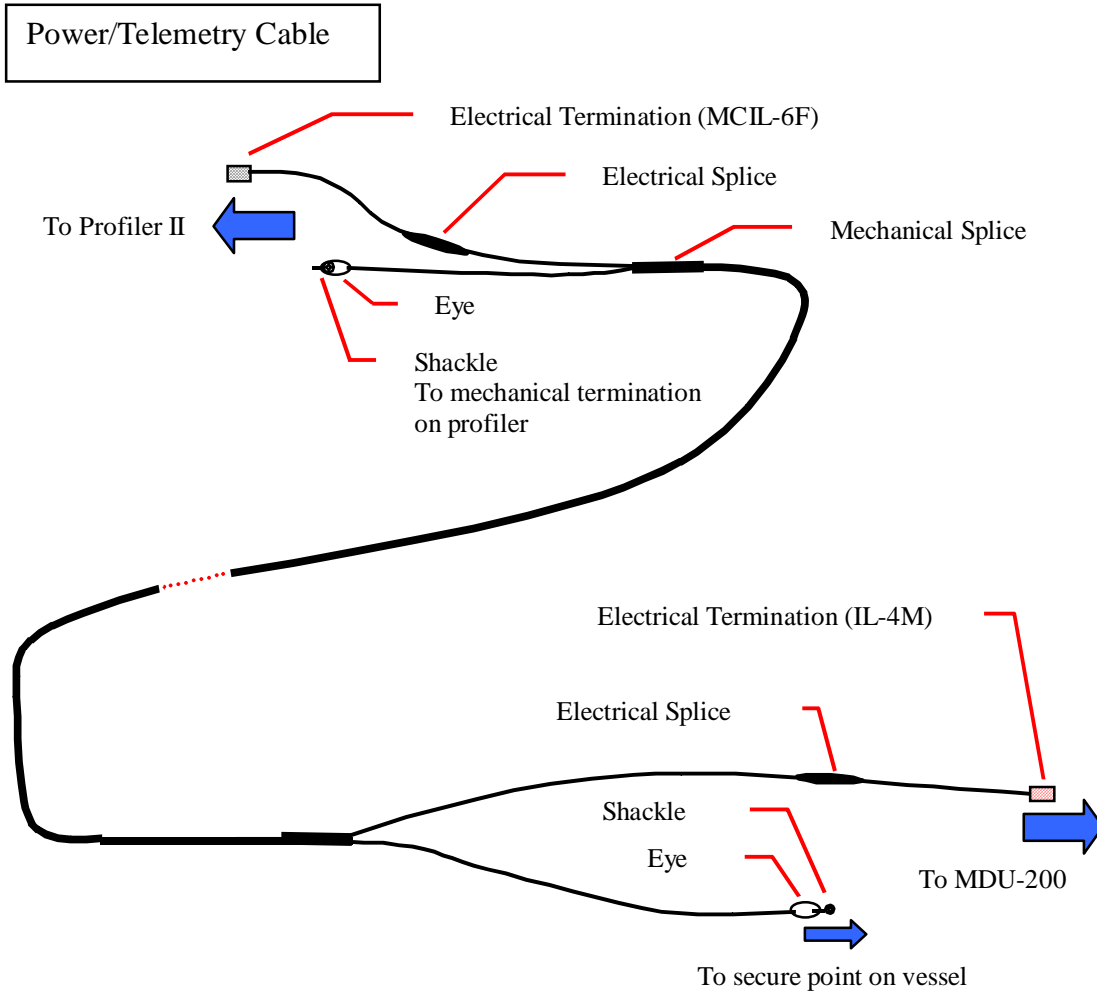



Figure C-2: Power/Telemetry Cable Connections

### DISTANCE MEASUREMENTS

Two important distance offsets need to be measured and documented so that Prosoft can process correct depths for each radiometer mounted to the profiler. Most radiometer configurations can be adjusted in their profiler fin mounting clamps so these measurements should be rechecked before every deployment.

	SYSTEM	<b>Profiler II Ocean Profiler</b>
	SECTION	<b>C – START UP</b>

Refer to Figure C-3, Figure C-5, Figure C-6, and Figure C-6. Quick check distances are provided in Table C-2.

The first measurement required (*Distance to Pressure*) is the distance between the irradiance sensor and the pressure reference line. The distance from the cosine collector face of the irradiance radiometer to the face of the lower end-cap containing the pressure sensor is measured. The pressure sensor reference line is a fixed distance above the face of the lower end-cap containing the pressure sensor, as shown in the figures. Subtracting that fixed distance from the measurement to the end-cap face gives the distance of the irradiance sensor to the pressure reference line.

The second measurement (*Distance to Irradiance*) required is the distance between the radiance sensor and the irradiance sensor. The distance from the cosine collector face of the irradiance radiometer to the glass window face of the radiance radiometer is calculated by adding the distance from the cosine collector face to the top of the sensor clamp, the thickness of the clamp, and the distance from the bottom of the clamp to the radiance sensor front guard and subtracting the fixed distance that the window is recessed from the guard.

Satlantic factory mounts the HyperOCR sensors such that the distances are 0.786 m and 0.316 m respectively. 500 series multispectral radiometers are offered in two configurations. IR sensors have the irradiance and radiance sensors mounted to the same coupler with a fixed mounting clamp. They cannot be separated from one another. Individual irradiance and radiance 500 series sensors can also be mounted on the profiler. These radiometers are adjustable in their fin clamp and are generally mounted on opposing sides of the profiler fin assembly. The table below lists the factory settings for the most popular configurations. **Note that systems delivered prior to September 2008 may not be set to the new default configurations and should be checked using Table C-2.**

Radiometer	Distance to Pressure	Distance to Irradiance
HyperOCR ICSW (as Ed)	0.786 m	0
HyperOCR ICSW (as Eu)	0.470 m	0
HyperOCR R08W	0.470 m	0.316 m
OCR 507 IR	0.796 m	0.287 m
OCR 507 ICSW	0.697 m	0
OCR 507 R10W	0.597 m	0.100 m

*Table C-1: Factory standard sensor distance settings*

To verify and/or to reset the radiometer distances to the factory standard the following table can be used (this is recommended as the factory standard values

 <b>Operation Manual</b>	SYSTEM	<b>Profiler II Ocean Profiler</b>
	SECTION	<b>C – START UP</b>

are automatically set by ProSoft 8.0 (hyperspectral sensors only) when loading cal files and can save considerable time if the defaults are used). These distance reference from the designated sensor reference point to the top or bottom of the radiometer clamps as shown in the following figures (IR type sensors – see Figure C-5 are fixed).

Radiometer	Distance to Clamp	Sensor Reference	Clamp Reference	See Figure
HyperOCR ICSW (as Ed)	11.5 cm	Edge of diffuser baffle	Top	C-3
HyperOCR ICSW (as Eu in surface mode)	14.5 cm	Edge of diffuser baffle	Bottom	C-4
HyperOCR R08W	14.5 cm	Face of window	Bottom	C-3
OCR 507 IR	Fixed	Fixed	Fixed	C-6
OCR 507 ICSW	2.6 cm	Edge of diffuser baffle	Top	C-5
OCR 507 R10W	2.7 cm	Edge of sensor	Bottom	C-5

*Table C-2: Distances to check factory settings*

If the factory default distances are used, these will match with the automatic default values for distances in ProSoft 8.0 as documented in Table C-3 below.

Radiometer	Distance to Surface	Distance to Pressure
HyperOCR ICSW (as Ed)	0	0.786 m
HyperOCR ICSW (as Eu if in surface mode as reference)	0.200 m	0.470 m
HyperOCR R08W	0.316 m	0
HyperOCR R08W (if Eu present in surface mode as reference)	0.200 m	0

*Table C-3: ProSoft 8.0 default distances for factory settings*

 <b>Operation Manual</b>	SYSTEM	<b>Profiler II Ocean Profiler</b>
	SECTION	<b>C – START UP</b>

HyperOCR R & I

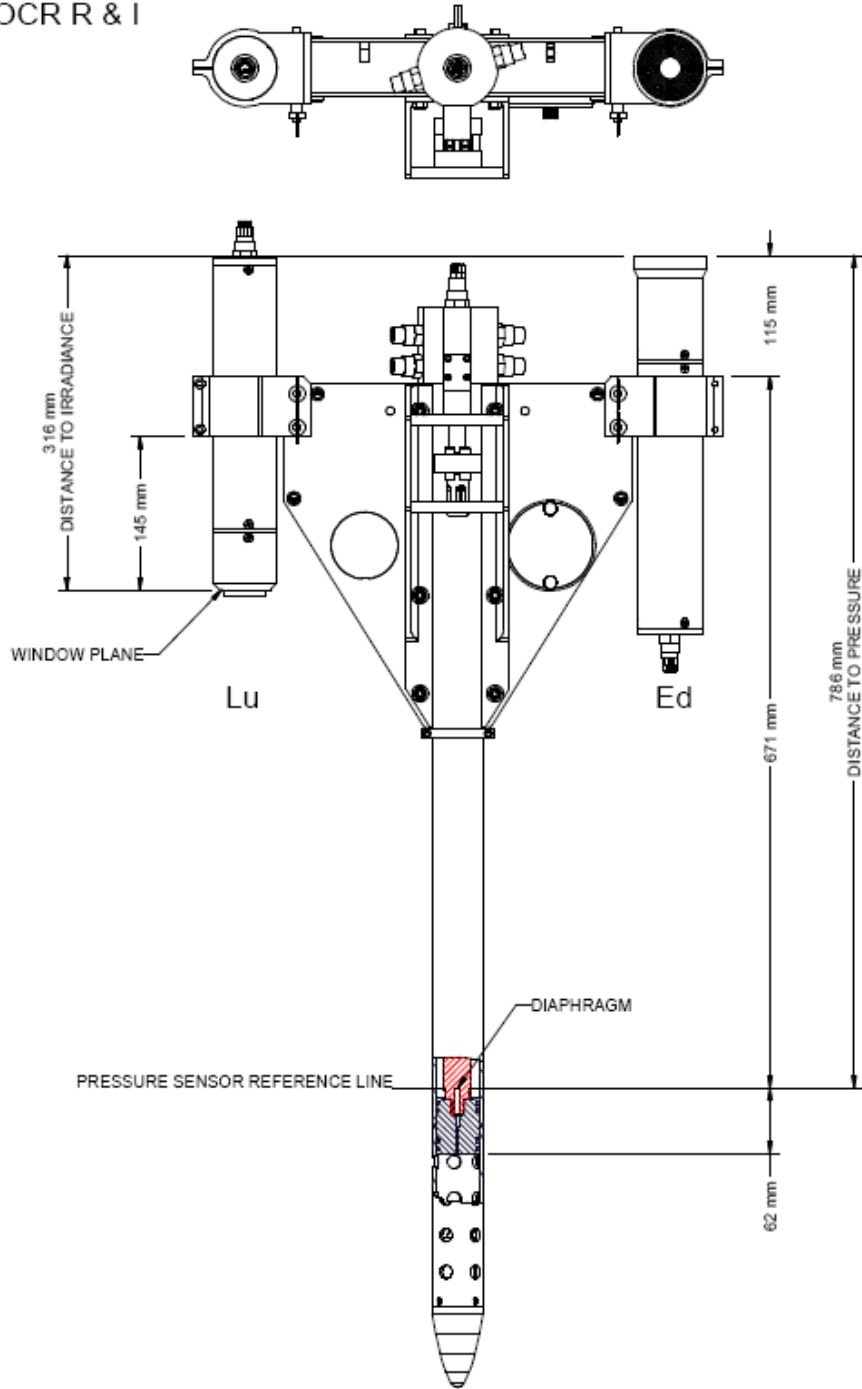



Figure C-3: Sensor Position Measurements: Profiler II with HyperOCRs

 <b>Operation Manual</b>	SYSTEM	<b>Profiler II Ocean Profiler</b>
	SECTION	<b>C – START UP</b>

HyperOCR R & I

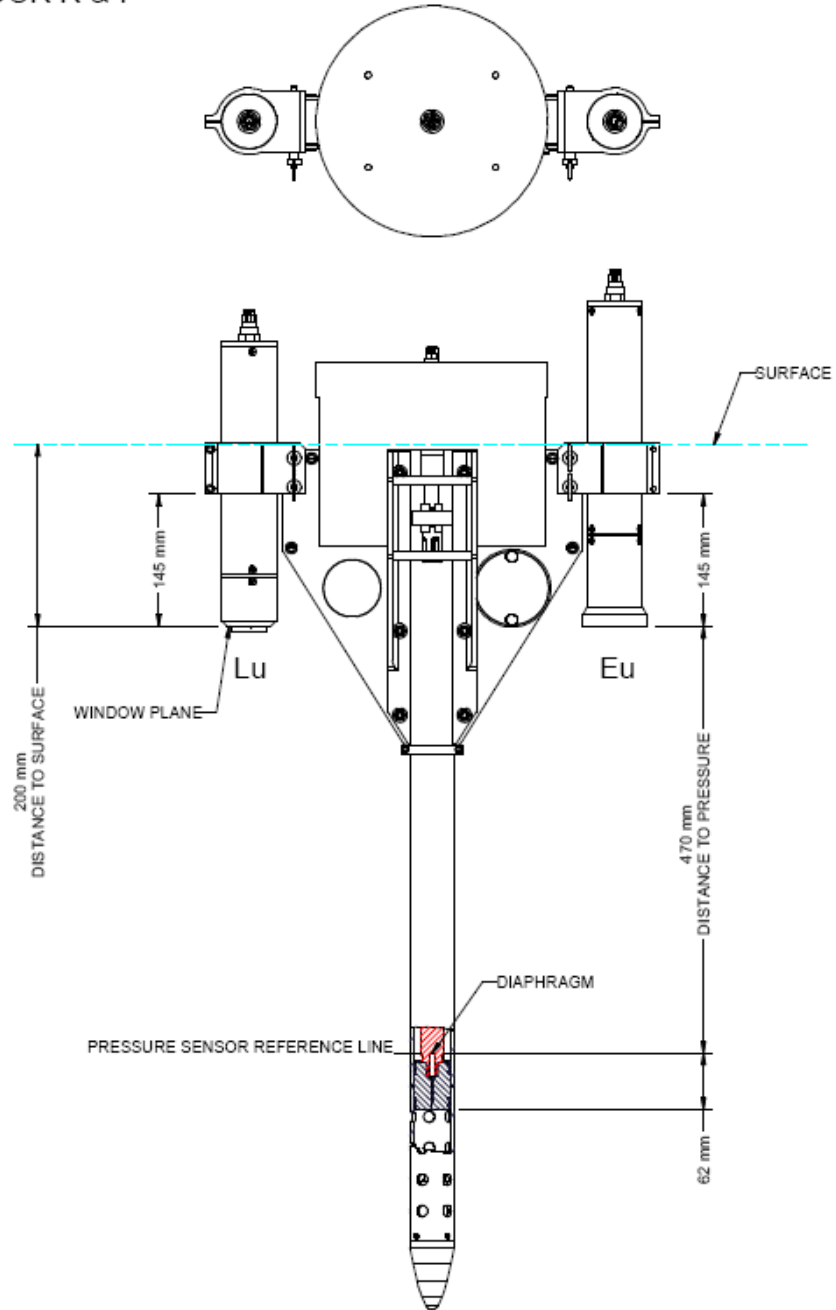



Figure C-4: Sensor Position Measurements: Profiler II with HyperOCRs in Surface Mode

 <b>Operation Manual</b>	SYSTEM <p style="text-align: center;"><b>Profiler II Ocean Profiler</b></p>
	SECTION <p style="text-align: center;"><b>C – START UP</b></p>

OCR-507 R & I

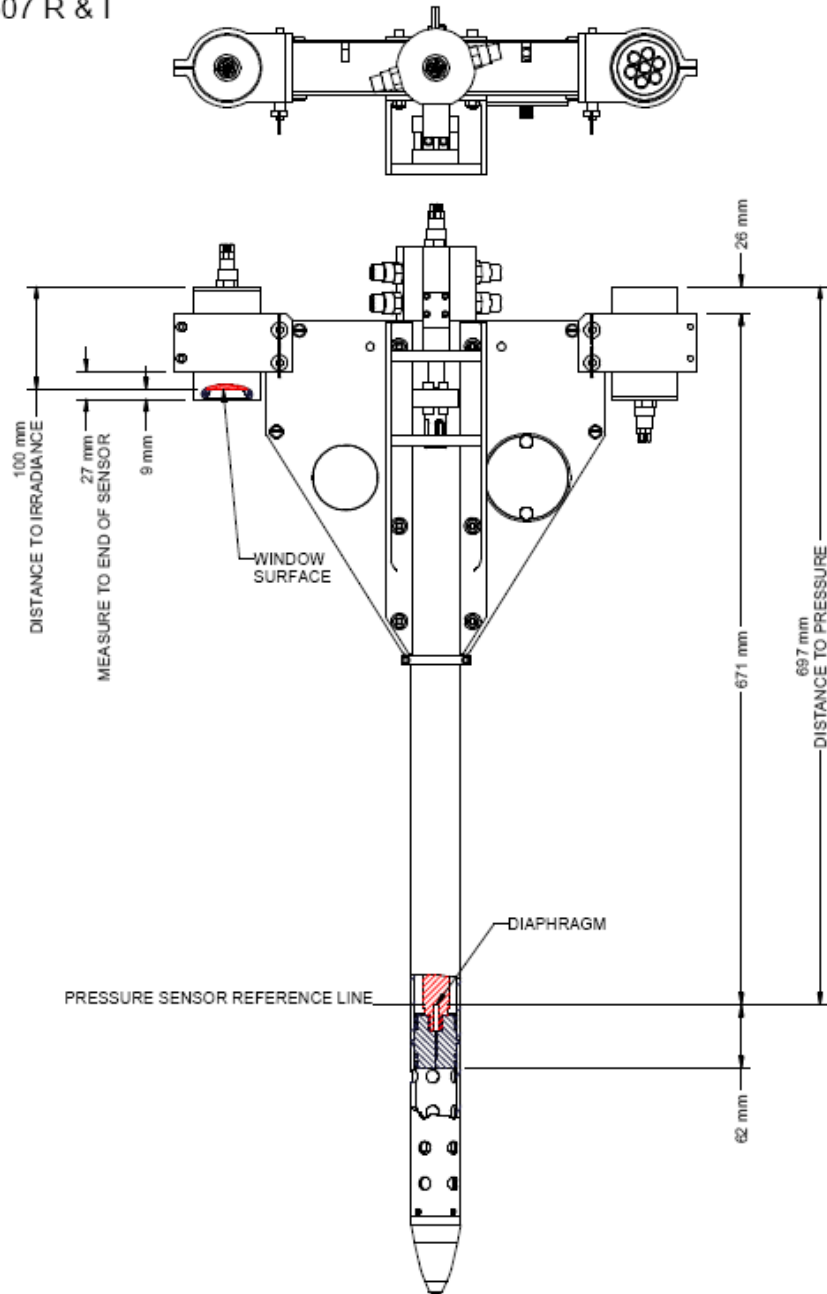



Figure C-5: Sensor Position Measurements: Profiler II with OCR-507s



 <b>Operation Manual</b>	SYSTEM <p style="text-align: center;"><b>Profiler II Ocean Profiler</b></p>
	SECTION <p style="text-align: center;"><b>C – START UP</b></p>

OCR-507 IR

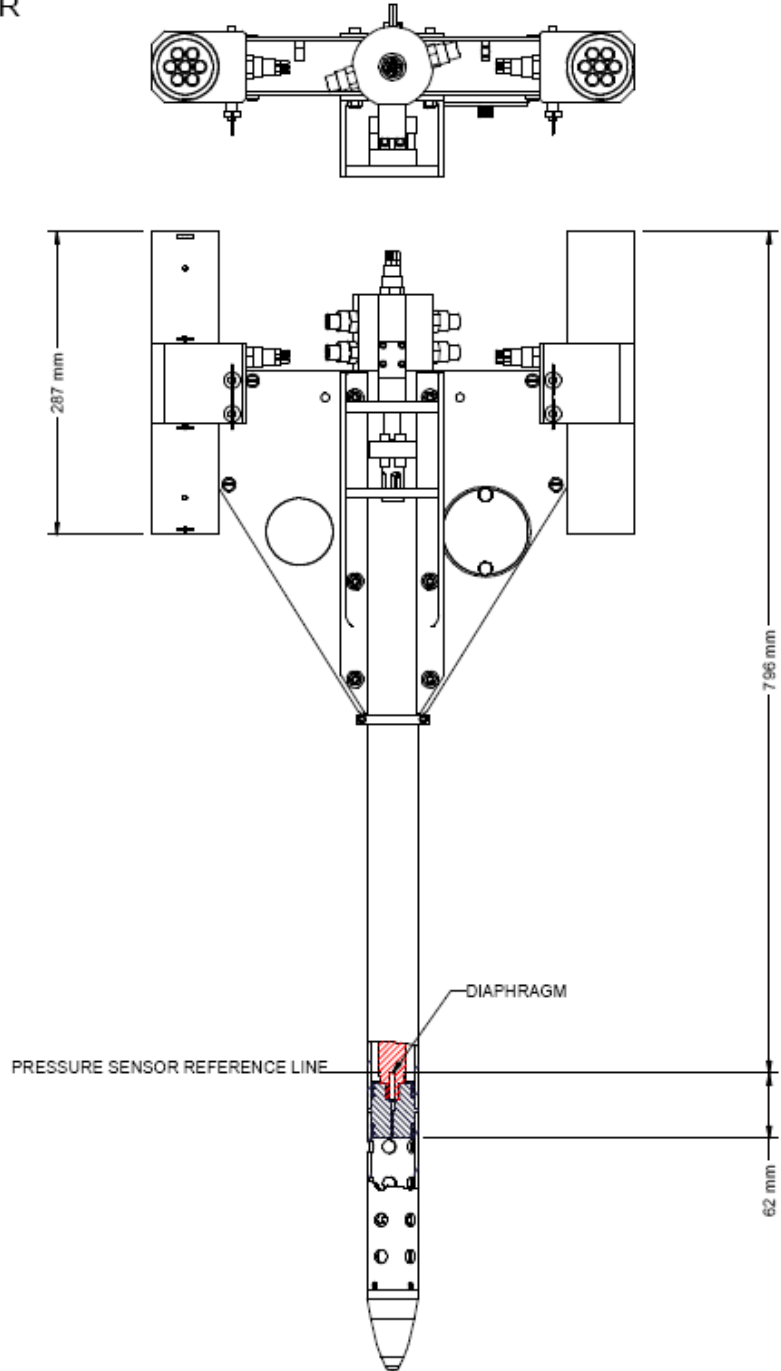

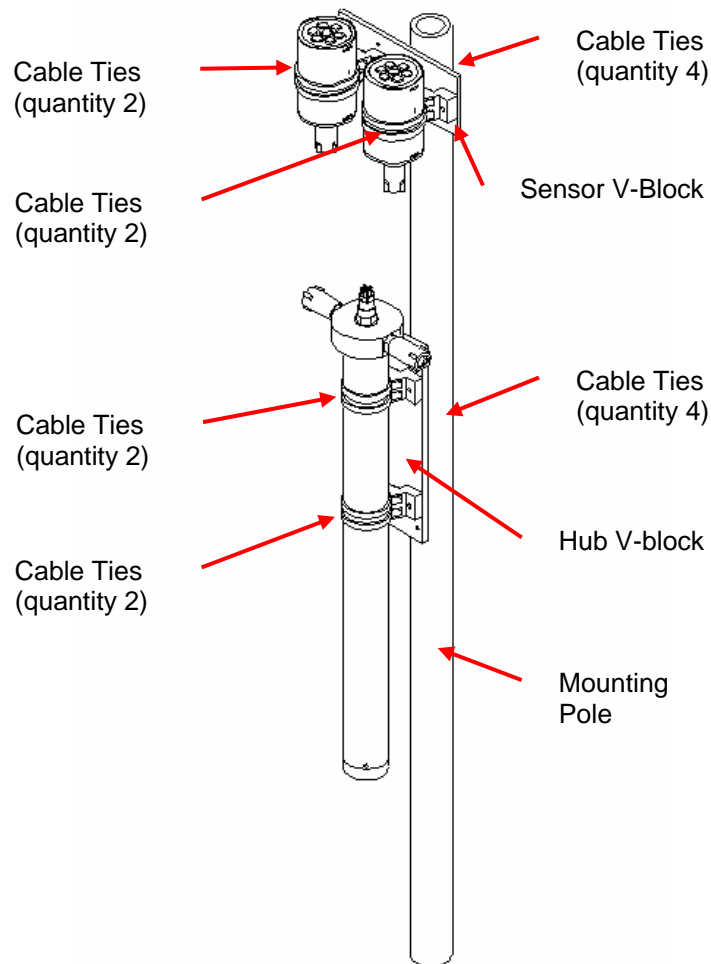

Figure C-6: Sensor Position Measurements: Profiler II with OCR-507 IR

	SYSTEM	<b>Profiler II Ocean Profiler</b>
	SECTION	<b>C – START UP</b>

### MOUNTING THE REFERENCE SYSTEM

The surface reference sensors should be mounted high on the vessel to eliminate shading from the ship's superstructure. Satlantic normally provides a simple V-block mounting system for the reference sensors and hub (if present), allowing them to be mounted to a small pole using inexpensive cable ties. Refer to the following figure for V-Block placement and cable tie attachment points. Note that instrument cables are not shown for clarity.



*Figure C-7: Reference Sensor Mounting*

Your reference sensor configuration may be different than that shown, but all mounting configurations will be similar in nature.

 <b>Operation Manual</b>	SYSTEM	<b>Profiler II Ocean Profiler</b>
	SECTION	<b>C – START UP</b>

Once the Profiler II has been properly connected and power has been applied, an initialization sequence will begin automatically to ready the device for normal operation. This sequence takes approximately 4 seconds to complete. Once finished, the instrument should begin normal operation. See the **Conducting a Telemetry Test** section below to make sure that your instrument is working properly. If this does not happen, remove power from the instrument and repeat the connection sequence. If you are still experiencing problems, contact a Satlantic customer service representative for assistance.

See section **D - OPERATION** for more information on operating your instrument.

See section **E - RECOVERY** for information on recovering and disconnecting your instrument after use.

## NETWORK NOTES

The Profiler II is capable of functioning as a stand-alone instrument or as one node in a network of other SatNet network capable instruments. Networking the instruments effectively allows one instrument (the *Network Master*) to share its telemetry interface with all instruments in the network. In this way, only one serial connection is needed for an array of instruments. Alternatively, if these instruments were all operating independently, each one would require a dedicated serial port on the data acquisition computer.

The Profiler II and its optical sensors use SatNet, a proprietary Satlantic networking protocol. To create a SatNet network, all devices must be compliant with the protocols and at least one must be Network Master capable. One and only one instrument may behave as the Network Master at a time. This instrument, during normal operation, will be the only one with a useable telemetry interface. In the Profiler II system, the Profiler II vehicle is the Network Master; while the optical sensors are Network Slaves. OCR-500 series instruments are **not** Network Master capable.

	SYSTEM	<b>Profiler II Ocean Profiler</b>
	SECTION	<b>C – START UP</b>

## ***Conducting a Telemetry Test***

Before using an instrument in the field, a simple telemetry test should be conducted to ensure it is functioning properly. This is also a good way to familiarize yourself with the software used with the instrument. The best way to conduct this test is to use SatView with the calibration files provided with your instrument. With the Profiler II, there will be a calibration file for the Profiler II and each slave sensor (OCR-500, HyperOCR, and foreign sensors) in the system. These calibration files are normally packaged as a SIP file, which allows quick and easy setup with SatView. Setup SatView as described in the manual or on-line help. Next, complete the ***Assembly Procedure*** described above and ensure that SatView is receiving telemetry.

For a more comprehensive test, you will need to check the instrument status more thoroughly to ensure the telemetry received by SatView is correct. Below are a few guidelines to help you with the test:

- Enable SatView's *Frame Counter* and *Check Sum* error checking to confirm that the data integrity is stable.
- Look at the spectral output to make sure there are no glaring errors in the data, i.e. unexpected peaks and valleys in the spectrum.
- Look at the spectral output under varying light conditions to make sure the spectrum is adjusting accordingly.
- Log a few minutes of telemetry and process the log file with SatCon. Check for errors in the data and consistency in the optical sensor values.

This test assumes that the instrument(s) you are testing are operating with *free-running* telemetry. This means that telemetry from the system is broadcast on a continuous basis. See section ***D - OPERATION*** for more information on controlling your instrument's telemetry output.

Once you are satisfied that the instrument(s) are working correctly, the next step is to deploy it for fieldwork. Otherwise, if you are experiencing any problems receiving telemetry, see section ***F - MAINTENANCE*** for information on troubleshooting your instrument. If you are still experiencing problems, contact a Satlantic customer service representative for assistance.

 <b>Operation Manual</b>	SYSTEM	<b>Profiler II Ocean Profiler</b>
	SECTION	<b>D - OPERATION</b>

## **D - OPERATION**

To begin operation of your instrument, complete the Assembly Procedure described in section **C - START UP**. Once power is applied, instrument operation begins automatically.

Two operators are required to deploy the free-fall or frame-mounted Profiler II, one to operate the computer and one to handle the instrument. The operators will need to communicate with each other during deployment, so if they are out of hearing range, radios or another communication means will be required.

The following sections describe the deployment and operation of the Profiler II in greater detail.

### ***Deployment Procedure***

#### **FREE-FALL DEPLOYMENT**

The advantage of the free-fall deployment technique is that it is a straightforward method of making measurements away from a vessel to drastically reduce or completely avoid ship-induced perturbations, so clean passive optical sensor data can be collected.

	SYSTEM	<b>Profiler II Ocean Profiler</b>
	SECTION	<b>D - OPERATION</b>

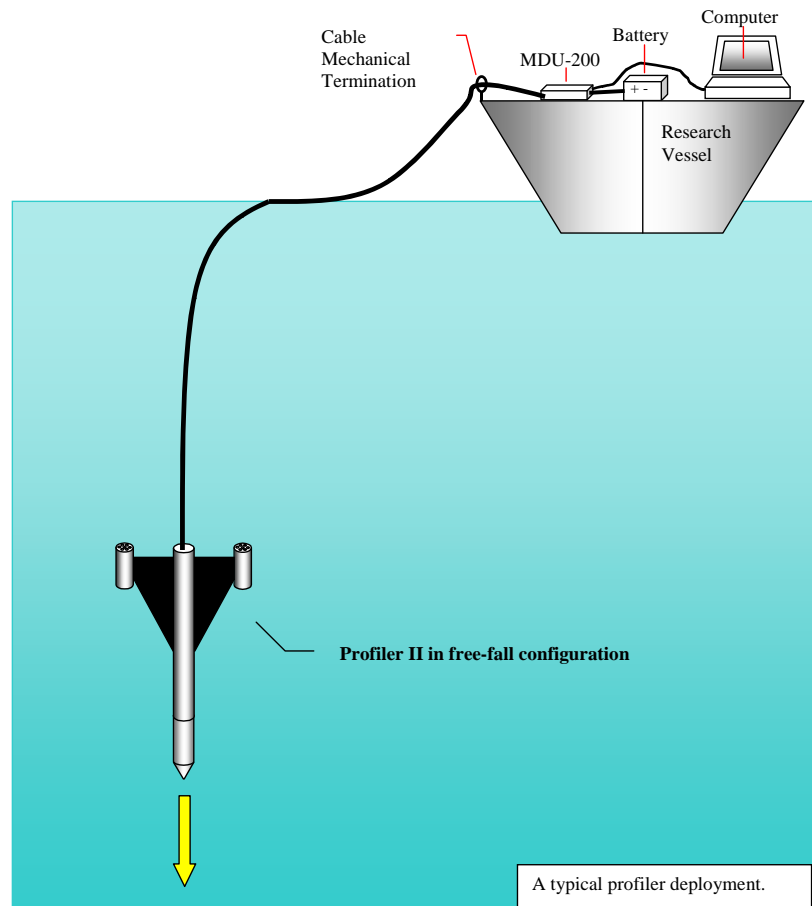

*Figure D-1: Free-Fall Deployment*

The Profiler II is a superior slow descending, free-fall vehicle. The descent rate of the instrument is adjustable from approximately 0.1 m/sec to 1.0 m/sec. To modify the drop rate, simply add or remove lead weights from the nose cone. The weights are mounted to a rod located inside the flooded coupler. Additional small lead sheets can also be wrapped around the outer diameter of the flooded coupler with electrical tape. The instrument is normally preset at Satlantic with a descent rate of 0.3 m/sec; 0.1 to 0.3 m/sec is recommended for Case-II waters. It may be desirable to check the drop rate while the instrument is close to the boat to ensure it is profiling at the correct speed. Small adjustment weights and electrical tape are provided in the spares kit.

The Profiler II should be readied to collect data at a minimum distance of 20 m from the deployment vessel. Carry out a pressure tare as described in the section, Conducting a Pressure Tare, below. The instrument should be carefully lowered to the water by slowly releasing the cable hand over hand. If the vessel is drifting, the Profiler II should be deployed on the windward side and the cable paid out slowly, with quick pulls on the cable, so that the instrument remains close to the surface but is constantly moving farther away from the vessel. If the

 <b>Operation Manual</b>	SYSTEM	<b>Profiler II Ocean Profiler</b>
	SECTION	<b>D - OPERATION</b>

vessel is not drifting or is very large, the profiler should be lowered in the water at the stern so the boat propulsion can adequately separate the instrument from the boat. If there is difficulty in getting the instrument to move away from the boat, connecting the power/telemetry cable at a lower attachment point and performing several mock deployments to 10 meters depth or so may be helpful. When the instrument is sufficiently far away from the ship pull it to the surface and as soon as it starts to freefall hit the start log button in SATView. The planned profile should always be less than the maximum water depth! When the instrument reaches the bottom of the cast hit the stop logging button in SATView. The profiler can then be pulled back to the surface and if the conditions described above are met, and new profile can be performed. The goal is to profile at a constant velocity with tilts as close to zero or vertical as possible (typically less than 5 degrees is acceptable; less than 2 degrees desirable). Collecting multiple casts (up and down) in one raw file will create difficulties during post processing with Prosoft and must be avoided (unless you are planning to use ProSoft 8.0 or higher and use the new "Multi-Cast Technique" described in the next section). If you have any questions or would like to see a video of a Profiler II system being deployed please contact Satlantic.

### **MULTI-CAST FREE-FALL DEPLOYMENT**

A new technique for deploying the profiler in freefall was developed by Dr. Giuseppe Zibordi of the Joint Research Centre, particularly for coastal waters to improve the retrieval of normalized water leaving radiances. The technique was adopted by a NASA cal/val project, SORTIE (Spectral Ocean Radiance Transfer Investigation and Experiment) to lower uncertainties in water leaving radiances and specialized processing to take advantage of this new technique has been implemented in ProSoft 8.0. By using the technique described in this section, investigators can easily achieve regressions for diffuse attenuation coefficients and water leaving radiances with over 100 samples/m even with hyperspectral systems. This leads to significant improvements in derived parameter precision and accuracy in both Case-I and Case-II waters.

For the multicast technique, the idea is to generate multiple profiles to a relatively shallow depth (ie 10m for Case-II, 20-30m for Case-I) in a short time frame (5-10 minutes) and log them all in the same file. When the data is processed all the data points (that pass tilt criteria) are used to generate the regression (see Figure D-2 for an example).

Follow the procedures for a normal single cast profile as described in the Free-Fall Deployment as section above, except when the profiler reaches the preselected maximum depth ((ie 10m for Case-II, 20-30m for Case-I), bring the instrument back to the surface but **do not stop logging in SatView**. Instruct the person deploying the instrument that when the profiler gets to the surface they should automatically begin another cast. Repeat this process for a total of 5 casts, then hit the stop log button in SatView. If you are using both single cast and multicast profiles on one cruise to compare results, you may want to consider different file naming codes for the different techniques. For example in the SORTIE program the following file naming format was used:

EEEE\_YYYY-MM-DD\_dn.RAW

	SYSTEM	<b>Profiler II Ocean Profiler</b>
	SECTION	<b>D - OPERATION</b>

EEEEE = experiment name  
 YYYY = year  
 MM = month  
 DD = day  
 d = deployment technique (P = single cast, S = multicast, T = surface mode)  
 n = SatView autocast letter

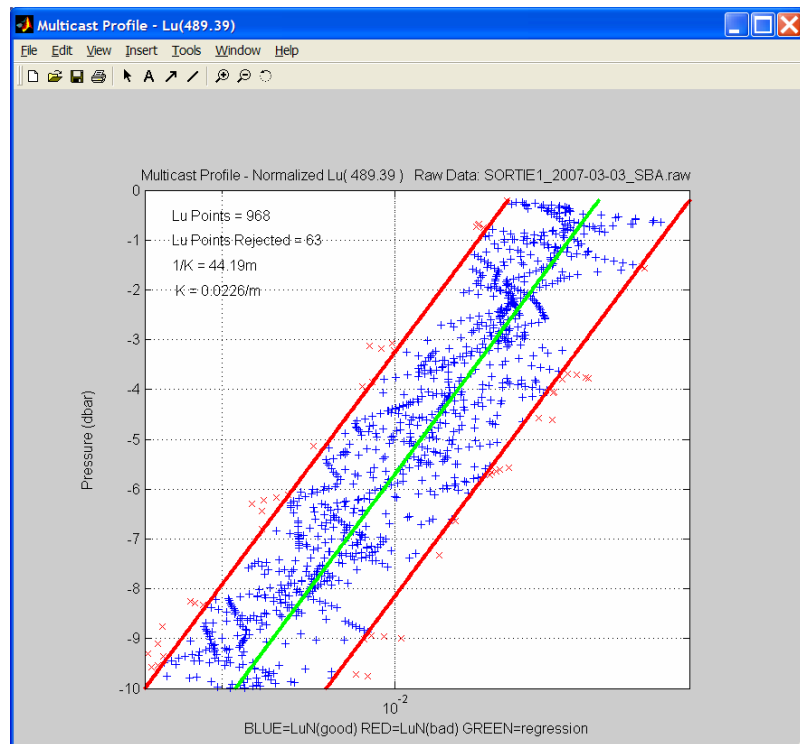



Figure D-2: Typical multicast regression processing ProSoft 8.0

## FRAME MOUNTED DEPLOYMENT

When using the frame-mounted version of the profiler, the length of the boom used dictates the distance that the instrument can be deployed from the boat. The complete avoidance of ship shadow is mandatory for all radiometric measurements to be incorporated into the SeaWiFS validation and algorithm database. The minimum deployment distance away from the ship can be calculated as per instructions in the "SeaWiFS Technical Report Series, Volume 25, Ocean Optics Protocols for SeaWiFS Validation", by James L. Mueller and Roswell W. Austin. This document is not normally included with the instrument but is available from the NASA Center for AeroSpace Information, 800 Elkridge Landing Road, Linthicum Heights, MD 21090-2934, (301) 621-0390. The instrument should be deployed from the sunny side of the boat. When deploying from the stern, the boat should be positioned so that the instrument can be



 <b>Operation Manual</b>	SYSTEM	<b>Profiler II Ocean Profiler</b>
	SECTION	<b>D - OPERATION</b>

deployed with the sun's relative bearing aft of the beam. Boom deployments are generally performed from either the port or starboard side of the boat.

See Figure D-3: Frame Mounted Deployment

**INCORRECT**



**CORRECT**



*Figure D-3: Frame Mounted Deployment*

 <b>Operation Manual</b>	SYSTEM	<b>Profiler II Ocean Profiler</b>
	SECTION	<b>D - OPERATION</b>

First the power/telemetry cable should be wound onto the cable block, ensuring the secure attachment of the vessel end to a hard attachment point on the boat and the instrument end to the lowering harness of the frame. The block should ensure that the cable cannot skip off the roller and get caught. Carry out a pressure tare as described in the section, Conducting a Pressure Tare, below. The instrument can then be guided over the side of the boat and lowered into the water. Before lowering the frame, ensure that the lowering harness connectors are seated properly in the eyebolts, as shown in the figure.

### CONDUCTING A PRESSURE TARE

A pressure tare is required to zero the pressure sensor in all Satlantic optical systems that measure depth. When the instrument is ready to deploy, a dry pressure tare should be performed with the instrument on deck. Left and then right click on the HPROII package field (suitcase icon) in the main SATView GUI and click View List and then Ancillary View. Once the pressure tare button is activated an offset in meters is logged in the header of each raw file generated after the tare. If power is cycled to the instrument or if SATView is shut down and re-launched, a new pressure tare should be performed. SATView subtracts this offset from the DEPTH field and will now provide the actual depth of the profiler. Prosoft also uses this data to correct for the pressure offset during post processing.

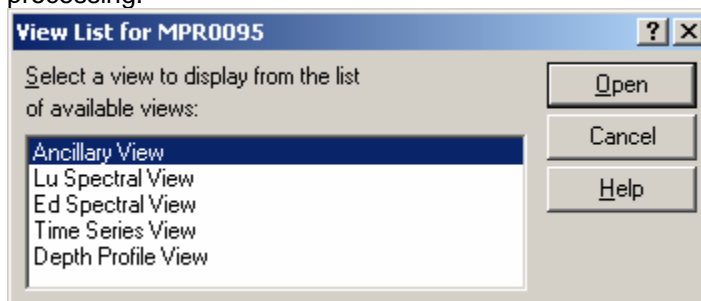

 <b>Operation Manual</b>	SYSTEM	<b>Profiler II Ocean Profiler</b>
	SECTION	<b>D - OPERATION</b>

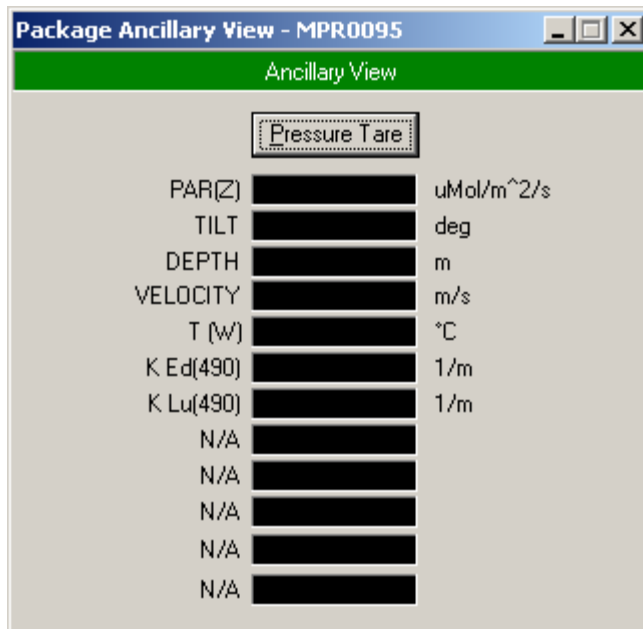

Figure D-4: Pressure Tare in SatView

After the pressure tare has been conducted, the instrument may be lowered if frame mounted or dropped if it is free falling. The instrument operator informs the computer operator when to start logging so that the required data is obtained. The instrument operator then pays out the cable until the desired depth is reached before informing the computer operator to stop logging data.

## SURFACE MODE DEPLOYMENT

The Profiler II system is equipped with a flotation collar surface mode operation for real-time, near surface measurements. Upwelling radiance and irradiance measurements can be made as close as 5 cm below the surface.

See Figure D-5: Profiler II in Surface Mode

*To operate the Profiler II in surface mode, attach the flotation collar by sliding it down over the power/telemetry connector and hooking the elastic retaining cords onto the lower collar as shown in Figure D-6: Float installation for Profiler II Surface Mode*

Invert the irradiance sensor such that it becomes an upwelling irradiance (Eu) sensor, that is, it looks down towards the nose of the Profiler II. Normally, the irradiance sensor is configured as a downwelling irradiance (Ed) sensor when in free-fall mode. This is required as the cosine collector is for in-water use only – it will not function properly in air. The downwelling irradiance measurements are then normally provided by a separate surface reference sensor.

 <b>Operation Manual</b>	SYSTEM <p style="text-align: center;"><b>Profiler II Ocean Profiler</b></p>
	SECTION <p style="text-align: center;"><b>D - OPERATION</b></p>

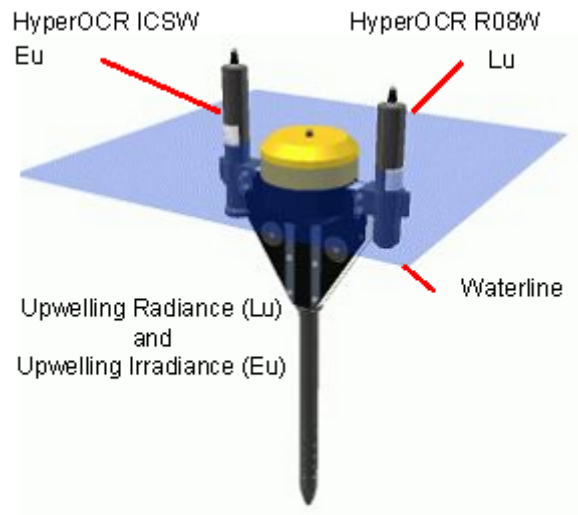

*Figure D-5: Profiler II in Surface Mode*

 <b>Operation Manual</b>	SYSTEM	<b>Profiler II Ocean Profiler</b>
	SECTION	<b>D - OPERATION</b>



*Figure D-6: Float installation for Profiler II Surface Mode*

### ***Profiler II Operating Modes***

The Profiler II can operate in one of three primary operating modes – Autonomous, Network, or Network Master Operation. These operating modes are collectively called *normal operation* and are described in detail below. The instruments configuration and physical environment determine which mode the instrument will operate in. **In most circumstances, the profiler will be configured for Network Master operation.** This is done during the initialization sequence, which begins immediately after power is applied to the instrument. Once the initialization sequence completes, normal operation begins. This will continue until power is removed or the instrument is reset.

**IMPORTANT!** This section goes into detail about the SatNet aspect of the Profiler II, and is intended for advanced users only. Most users will not require any knowledge of this system, as the instrument is essentially a “plug and play” device when used with SatView. Changing any parameters will affect system operation – please discuss any changes with a Satlantic representative before modifying these settings.

### ***Initialization Sequence***

Once power is applied to the Profiler II, the instrument begins a four-second window of operation called the initialization sequence. During this time, the on-board electronics are powered up, checked, and readied for operation. If the

 <b>Operation Manual</b>	SYSTEM	<b>Profiler II Ocean Profiler</b>
	SECTION	<b>D - OPERATION</b>

*silent mode configuration parameter*<sup>6</sup> is disabled, a start-up banner will be output on the telemetry interface, similar to the one shown below:

```
Satlantic MicroPro Profiler 2
Copyright (C) 2002, Satlantic Inc. All rights reserved.
Firmware version: 1.1A(P), 1.1A(S) - SatNet Type A
Instrument: SATMPR
S/N: 0054
```

```
Reset Source: Power
Press <Ctrl+C> for command console.
Initializing system. Please wait...
```

This banner is a simple text message that can be viewed in a terminal emulator. See section **G - CONFIGURATION** for more information on setting up a terminal emulator to monitor output from the telemetry interface.

The first section of the banner identifies the instrument. Specifically, the first line identifies the instrument type. The firmware (or microcontroller software) version is identified on the third line. This line also defines the SatNet compliance used by the instrument. *Type A* compliance uses a dual processor control system capable of operating as a Network Master. *Type B* compliance is a smaller, single processor system without Network Master capabilities. The next two lines define the instrument type identifier and serial number used at the beginning of a telemetry frame. See the **Telemetry Format** section below for more information on the instrument's telemetry frames.

The next section of the banner gives additional information related to the initialization sequence. The first line identifies the mode in which the system was initialized. *Power* indicates that the instrument began operation after power was applied. *Software* indicates that a *reset* command was issued to the instrument to reboot itself. *External* may mean that a brown out (or brief interruption in power input) occurred and the processor reset itself.

The next line of this section gives instructions on how to access the **Command Console**. In most cases, the command console would be accessed during normal operation. If this is done during the initialization sequence, the instrument will be forced into autonomous operation before the console is displayed. This gives the ability to break into the command console even if the instrument is configured to run in a network. Note that the command console is not displayed until the initialization sequence completes. See section **G - CONFIGURATION** for more information on accessing and using the command console.

Once the initialization sequence has finished, normal operation begins. If silent mode is disabled, one of the following messages will be output, depending on which operating mode is enabled.

```
Autonomous operation enabled.
```

or

```
Network operation enabled.
```

<sup>6</sup> Configuration parameters are discussed in detail in section **G - CONFIGURATION**.

	SYSTEM	<b>Profiler II Ocean Profiler</b>
	SECTION	<b>D - OPERATION</b>

or

Network Master operation enabled.

### ***Autonomous Operation***

Autonomous, or stand-alone, operation for the Profiler II is defined as the continuous operation of the instrument outside the scope of a network. This mode of operation is not normally used with the Profiler II. Autonomous operation uses only the telemetry interface for communication and telemetry output. The network interface is disabled.

During autonomous operation, the default behavior of the instrument is to continually sample its ancillary sensors and output telemetry on the RS-232 and RS-422 telemetry interfaces. When the instrument is used in the field, this telemetry would be collected and saved to a storage medium. Generally, a data acquisition application like SatView would be used. If you are using your Profiler II in an embedded system, another mode of telemetry acquisition may be more appropriate. When telemetry output is free-running, as described above, no user input is required to operate the instrument.

However, telemetry output can also be controlled with simple commands sent to the instrument through the telemetry interface. As this involves two-way communication, only the RS-232 telemetry interface can be used, unless the instrument has been configured for full-duplex RS-422 communications. These commands are simple one-byte transmissions. In an embedded or larger scale system, the data acquisition software could use this feature to finely control telemetry output and instrument operation. These commands can also be sent directly by the user with a terminal emulation program, as discussed in section **G - CONFIGURATION**.

The following table defines these command bytes and their affect on the instrument. All commands, which are standard with all SatNet compliant instruments, are ASCII control characters. They are not echoed back so if you are using a terminal emulator to send these commands, you will not see any command values on the screen. For example, in a terminal emulation program, you would use the <Ctrl+C> command to access the command console. To do this, press and hold the Ctrl key followed by the C key. This is the same as sending the hexadecimal equivalent byte "03" to the instrument over the telemetry interface. This number is also indicated in the table.

Command	Hex	Description
<Ctrl+C>	03	This command interrupts normal operation of the instrument and invokes the <b>Command Console</b> . See section <b>G - CONFIGURATION</b> for more information.
<Ctrl+S>	13	This command stops <i>free-running</i> telemetry output, enabling <i>polled</i> telemetry output.

 <b>Operation Manual</b>	SYSTEM	<b>Profiler II Ocean Profiler</b>
	SECTION	<b>D - OPERATION</b>

Command	Hex	Description
<Enter> or <SPACE>	0D or 20	If the instrument is running with <i>polled</i> telemetry output, either of these commands will force the instrument to sample its sensors and return a telemetry frame.
<Ctrl+A>	01	This command stops <i>polled</i> telemetry output, enabling <i>free-running</i> telemetry output.
<Ctrl+P>	10	This command powers down the operational components of the instrument. This may reduce the instruments total power consumption, as any electronics associated with sensor operation will be turned off, if possible. The instrument is otherwise fully operational, so communication is still possible. When operational components are powered down, telemetry output is disabled, regardless of the telemetry output mode.
<Ctrl+U>	15	This command returns power to the operational components of the instrument if they were previously powered down. Telemetry output will resume based on the current telemetry output mode.
<Ctrl+R>	12	This command forces the instrument to reset itself. After a few seconds, the instrument will reboot and the initialization sequence will begin again.

*Table D-1: Optional telemetry control commands, Autonomous Mode*

With the exception of the <ENTER> and <SPACE> commands, repeatedly sending a command will have no effect. For example, you cannot power down operational components more than once.

The free-running and polled telemetry output modes described above are sub-modes of normal operation. When the instrument is free-running, telemetry frames are output from the instrument according to the *maximum frame rate* configuration parameter.

## **Network Operation**

Network operation for the Profiler II is defined as continuous operation of the instrument within the scope of a SatNet network. Furthermore, standard network operation means that the instrument is **not** operating as a Network Master device. While operating in this mode, only the network interface is used for communication. The telemetry interface is disabled.



	SYSTEM	<b>Profiler II Ocean Profiler</b>
	SECTION	<b>D - OPERATION</b>

To enable network operation, a number of criteria must be met; otherwise operation will default to running autonomously. First, the *network mode* configuration parameter must be enabled. Secondly, the network interface pins, NA and NB, must be physically connected to another SatNet instrument operating as a Network Master device. These first two conditions will ensure that network operation is invoked. However, to ensure proper operation of the network, additional criteria must be adhered to. Namely, the *network baud rate* configuration parameter must be set to the same baud rate as the Network Master. Finally, the *network address* configuration parameter must be unique to all other instruments in the network.

During network operation, the Profiler II is completely controlled by the Network Master. All communication is relayed through the network between the Network Master and the other instruments running in network operation mode. Instead of sending a telemetry frame through the telemetry interface, as is done in autonomous operation, each instrument sends its telemetry through the network interface to the Network Master. The Network Master then channels the telemetry through its telemetry interface where it can be collected by a data acquisition system.

The only way to gain control access of an instrument running in network operation mode is through the telemetry interface of the Network Master. A Network Master has a set of commands for controlling telemetry similar to that of an instrument running autonomously. These commands can also control other instruments in the network. For more information on the Network Master and its operational command structure, refer to the operating manual of your Network Master device.

### ***Network Master Operation***

Network Master operation for the Profiler II is defined as the continuous operation of the instrument within the scope of a SatNet network, acting as the Network Master. When operating in this mode, the instrument uses the network interface to obtain data from the slave devices and outputs the information, together with its own data, on the telemetry interface. This is the default operation mode for the Profiler II.

To enable Network Master operation, a number of criteria must be met. First, the *network mode* configuration parameter must be enabled. Secondly, the network interface pins, NA and NB, must be physically connected to other SatNet instruments operating as a Network Slave devices – there can be only one Network Master in a SatNet configuration. In addition, the *network master mode* parameter must be enabled. Finally, the *master network* bias parameter must be enabled. These conditions will ensure that network master operation is invoked. However, to ensure proper operation of the network, additional criteria must be adhered to. Namely, the *network baud rate* configuration parameter must be set to the same baud rate as the rest of the network instruments. Also, the *network address* configuration parameter must be unique to all other instruments in the network.

 <b>Operation Manual</b>	SYSTEM	<b>Profiler II Ocean Profiler</b>
	SECTION	<b>D - OPERATION</b>

During network master operation, the Profiler II completely controls the Network Slave devices. All communication is relayed through the network between the Network Master and the other instruments running in network operation mode. Instead of sending a telemetry frame through the telemetry interface, as is done in autonomous operation, each instrument sends its telemetry through the network interface to the Network Master. The Network Master then channels the telemetry through its telemetry interface where it can be collected by a data acquisition system (such as SatView).

As in autonomous mode, telemetry output can be controlled with simple commands sent to the instrument through the telemetry interface. As this involves two-way communication, only the RS-232 telemetry interface can be used, unless the instrument has been configured for full-duplex RS-422 communications. These commands are simple one-byte transmissions. In an embedded or larger scale system, the data acquisition software could use this feature to finely control telemetry output and instrument operation. These commands can also be sent directly by the user with a terminal emulation program, as discussed in section **G - CONFIGURATION**.

The following table defines these command bytes and their affect on the instrument. All commands, which are standard with all SatNet compliant instruments, are ASCII control characters. They are not echoed back so if you are using a terminal emulator to send these commands, you will not see any command values on the screen. For example, in a terminal emulation program, you would use the <Ctrl+C> command to access the command console. To do this, press and hold the Ctrl key followed by the C key. This is the same as sending the hexadecimal equivalent byte "03" to the instrument over the telemetry interface. This number is also indicated in the table.

Command	Hex	Description
<Ctrl+C>	03	This command interrupts normal operation of the instrument and invokes the <b>Command Console</b> . See section <b>G - CONFIGURATION</b> for more information.
<Ctrl+S>	13	This command stops <i>free-running</i> telemetry output, enabling <i>polled</i> telemetry output.
<Enter> or <SPACE>	0D or 20	If the instrument is running with <i>polled</i> telemetry output, either of these commands will force the instrument to sample its sensors and return a telemetry frame.
<Ctrl+A>	01	This command stops <i>polled</i> telemetry output, enabling <i>free-running</i> telemetry output.

	SYSTEM	<b>Profiler II Ocean Profiler</b>
	SECTION	<b>D - OPERATION</b>

Command	Hex	Description
<Ctrl+P>	10	This command powers down the operational components of the instrument. This may reduce the instruments total power consumption, as any electronics associated with sensor operation will be turned off, if possible. The instrument is otherwise fully operational, so communication is still possible. When operational components are powered down, telemetry output is disabled, regardless of the telemetry output mode.
<Ctrl+U>	15	This command returns power to the operational components of the instrument if they were previously powered down. Telemetry output will resume based on the current telemetry output mode.
<Ctrl+R>	12	This command forces the instrument to reset itself. After a few seconds, the instrument will reboot and the initialization sequence will begin again.
<Ctrl+N>	0E	This command is only available to the network master. After enabling polled telemetry, issuing this command followed by a valid network address allows the user to poll the slave device at that address. Press <Ctrl+N> to return to the master device.

Table D-2: Optional telemetry control commands, Network Master Mode

With the exception of the <ENTER> and <SPACE> commands, repeatedly sending a command will have no effect. For example, you cannot power down operational components more than once.

The free-running and polled telemetry output modes described above are sub-modes of normal operation. When the instrument is free-running, telemetry frames are output from the instrument according to the *maximum frame rate* configuration parameter.

### Telemetry Format

The telemetry format for the Profiler II, as with all Satlantic instrumentation, follows the Satlantic Data Format Standard. This standard defines how Satlantic telemetry can be generated and interpreted. For every sample taken of the instrument's sensors, the instrument will compose and transmit one frame of telemetry containing all the relevant sensor information for that sample. The

 <b>Operation Manual</b>	SYSTEM	<b>Profiler II Ocean Profiler</b>
	SECTION	<b>D - OPERATION</b>

format is the same regardless of the operating mode. The Profiler II generates a frame of telemetry with the following components:

Field Name	Field Size (bytes)	Description
Instrument	1 - 10	An AS formatted string denoting the start of a frame of telemetry. The sequence normally starts with "SAT" for a Satlantic instrument. The next series of characters would identify the type of instrument (or telemetry). This is normally a six-character field.  For the Profiler II, the string will be SATMPR
Serial Number	1 - 10	An AS/AI formatted string denoting the serial number of the instrument. This field combined with the INSTRUMENT field uniquely identifies the instrument. This combination is known as the frame header or synchronization string. This is normally a four-character field.
SV Sense	2	This field contains a BU formatted value indicating the regulated input voltage.
VA Sense	2	This field contains a BU formatted value indicating the analog rail voltage for the operational components of the instrument.
V15 Sense	2	This field contains a BU formatted value indicating the analog rail voltage for the pressure sensor (+15V nominal).
Int. Temp.	2	This field contains a BU formatted value indicating the internal temperature of the instrument.
AUX1	2	This field contains a BU formatted value for a spare ADC channel.
COND	2	This field contains a BU formatted value indicating the conductivity sensor reading. If the sensor is not present, this sensor is the AUX2 spare ADC channel.
AUX3	2	This field contains a BU formatted value for a spare ADC channel.
Pressure	2	This field contains a BU formatted value indicating the pressure sensor reading.

 <b>Operation Manual</b>	SYSTEM	<b>Profiler II Ocean Profiler</b>
	SECTION	<b>D - OPERATION</b>

Field Name	Field Size (bytes)	Description
Tilt X	2	This field contains a BU formatted value indicating the instruments tilt in the X direction.
Tilt Y	2	This field contains a BU formatted value indicating the instruments tilt in the Y direction.
Temp Tilt	2	This field contains a BU formatted value indicating the value of the temperature of the tilt sensor. This sensor is not calibrated.
Tw	2	This field contains a BU formatted value indicating the water temperature from the external temperature sensor.
FRAME COUNTER	1	A BU formatted data integrity sensor that maintains a count of each frame transmitted. The count increments by one for each frame transmitted from 0 to 255, at which point it rolls back to zero again.
TIMER	10	The field is an AF formatted string indicating the number of seconds that have passed since the end of the initialization sequence. This field is left padded with zeros and is precise to two digits after the decimal.
CHECK SUM	1	This is a BU formatted data integrity sensor which implements a check sum on the telemetry frame.
TERMINATOR	2	This field indicates the end of the frame. The frame is terminated by a carriage return/line feed pair (0D <sub>hex</sub> and 0A <sub>hex</sub> ).

*Table D-3: Profiler II telemetry format*

 <b>Operation Manual</b>	SYSTEM <p style="text-align: center;"><b>Profiler II Ocean Profiler</b></p>
	SECTION <p style="text-align: center;"><b>E - RECOVERY</b></p>

## E - RECOVERY

To recover the Profiler II, terminate data logging and pull the instrument back in using the power/telemetry cable. Take care not to jar the instrument or allow it to hit the side of the boat, as the system may include sensors that are susceptible to shock damage.

Power down the instrument and disconnect all the cables from their corresponding components. When disconnecting a cable from the instrument or any supporting apparatus, like the power supply, grasp firmly on the connector head and pull off the cable. **DO NOT TWIST THE CABLE OR PULL ON THE CABLE DIRECTLY AS THIS MAY DAMAGE THE CONNECTORS OR THE CABLE. ALWAYS DISCONNECT THE POWER SUPPLY FIRST.** Ensure the dummy connectors are put back in place so that the male pins are not damaged and the female pins remain clean.

Always be sure to rinse the instrument with fresh water prior to storage in order to prevent corrosion. If seawater is allowed to remain in contact with the instrument in storage, particularly around metallic parts, corrosion may occur. Failure to properly rinse the instrument before storage is considered misuse and warranty claims cannot be made under such circumstances.

Replace the vinyl or plastic end caps on the optical sensors. The instruments may then be stored in the packing boxes, ensuring they are packed properly to protect them from damage during transport.

	SYSTEM	<b>Profiler II Ocean Profiler</b>
	SECTION	<b>F - MAINTENANCE</b>

## F - MAINTENANCE

### *Preventative Maintenance*

The Profiler II requires virtually no maintenance. The life of the instrument will be prolonged by protecting it from impacts, rinsing it with fresh water after each use and properly storing the instrument with the dummy connectors and optical sensor end caps on when not in use.

If the instrument is not working properly the following troubleshooting techniques can be followed. If these are not successful, contact Satlantic for more information.

### *Troubleshooting with a Terminal Emulator*

If you are experiencing problems receiving data with your data acquisition software, there may be a problem with the instrument, its configuration, or its physical setup. You can check to see if your Profiler II is transmitting telemetry with a terminal emulator.

To do this, first complete the **Assembly Procedure** described in section **C - START UP**. Connect the instrument to a computer running a terminal emulation program. See section **G - CONFIGURATION** for more information on setting up a terminal emulator. For this test, you may use either the RS-232 interface directly, or the RS-422 interface through an appropriate level converter. You can therefore use the same physical configuration you would use in the field. However, if at a later point you need to gain access to the instruments command console, you will need to use the RS-232 interface directly.

Once the instrument is powered up and is in normal operation with free-running telemetry, you should see what looks like semi-random characters being periodically output to the display. This is normal. The instrument telemetry contains a lot of binary data, which is not normally processed by a dumb terminal. However, you should be able to periodically pick out the instruments frame header or synchronization string. This series of characters appears at the beginning of every frame of telemetry, as defined in your instrument's calibration file. If you do not see the frame header, but you do see random characters, check that the baud rate of the terminal emulator is the same as for the instrument. If you so not see anything at all, make sure that no other application is using the serial port of the computer. If this checks out, there may be a hardware problem.

	SYSTEM	<b>Profiler II Ocean Profiler</b>
	SECTION	<b>F - MAINTENANCE</b>

## ***Troubleshooting for Hardware Problems***

If a telemetry check using a terminal emulator failed to show any telemetry, you should check the physical connections of your instrument and supporting equipment.

To perform hardware checks, a multimeter with DC voltage measurement, resistance measurement, and continuity check capability is required.

**WARNING! While checking voltages, extreme care should be used so as not to short the probe leads. A shorted power supply or battery can output many amperes of current, potentially harming the user, starting fires, or damaging equipment.**

### **CHECK CONNECTIONS**

The cable connections of the system should be checked for continuity and correctness. Make sure that all connectors are free of dirt and lightly lubricated before mating. Do not use petroleum-based lubricants. Satlantic recommends using a light coating of DC-111 silicone grease (made by Dow Corning®) on the male pins prior to connection. Also, ensure that the connections are complete and, if applicable, the locking sleeves are secure.

- Check that the power cable is properly connected to the power supply and the instrument.
- Check that all instrument interconnect are in place and properly connected.
- Check that the RS-232 cable is connected to the correct PC communications port.

### **CHECK THE SUPPLY VOLTAGE TO THE MDU-200**

The MDU-200 deck unit is essentially a DC-DC converter. An input voltage in the range of 10 - 20 VDC is converted to a regulated 48 VDC. Voltages above the maximum input voltage of 20 VDC may damage the MDU-200; voltages below the minimum operating voltage of 10 VDC may cause the device to drop out of regulation. Thus the user should ensure the voltage input to the MDU-200 is within the allowed range of 10 - 20 VDC.

To check voltages, a multimeter with DC voltage measurement is required.

#### **Procedure:**

1. Set the multimeter to measure a DC voltage.
2. If using a battery as the power source, measure the voltage directly at the battery terminals with the multimeter. A new or fully charged 12 V battery usually measures in the 13 - 15 V range. If the voltage is low (under 11 V) then recharge or replace the battery. If using a DC power supply,



	SYSTEM	<b>Profiler II Ocean Profiler</b>
	SECTION	<b>F - MAINTENANCE</b>

set the output voltage in the range from 10 - 20 V, and check the voltage with the multimeter.

3. Connect the power supply cable to the power source.
4. **Being extremely careful not to short the probe leads**, measure the voltage between the pins on the supply cable. It should read approximately the same as the measurement taken in step 2. If the voltages are not the same, recheck the power supply cable connections. If the voltages are still not the same, the cable is likely broken and will need repair. A wire break can be confirmed with a *continuity check*.
5. If the voltage is within tolerance, connect the power supply cable to the MDU-200.
6. Again, measure the voltage at the power supply terminals. The voltage should remain approximately the same as before, although there may be a small voltage drop when using a battery (battery voltage drops under load). If there is a significant voltage drop, disconnect the power immediately and check for shorts in the cable.

### **CHECK THE OUTPUT VOLTAGE FROM THE MDU-200**

To check the output voltage from the MDU-200, a multimeter, as described above, is required. As previously mentioned, the MDU-200 outputs a regulated 48 VDC (nominal) voltage. Use the following procedure to check this voltage.

#### **Procedure:**

1. Set up the MDU-200 input power as outlined previously.
2. Ensure the multimeter is configured to measure DC voltage.
3. **Being extremely careful not to short the probe leads**, insert the negative (black) probe lead in Pin 2 and the positive (red) probe lead in Pin 1 of the BH-4F connector on the MDU-200. The measurement should read approximately +48 VDC. If it does, the MDU-200 is operating properly. If it does not, check all input connections to the MDU-200, and recheck the voltage. Also ensure that you are measuring between pins 1 and 2, and that the probe leads are making contact with the pin metal. If you still do not measure 48 V, the MDU-200 may need to be returned to Satlantic.

 <b>Operation Manual</b>	SYSTEM	<b>Profiler II Ocean Profiler</b>
	SECTION	<b>F - MAINTENANCE</b>

### **CHECK CABLE CONTINUITY**

Often, system problems can be traced to cable breaks or shorts. Usually, these cable failures are a result of improper handling or storage. Cable continuity can be checked as outlined below. **MAKE SURE ALL CABLES ARE COMPLETELY DISCONNECTED BEFORE PERFORMING THIS TEST.**

#### **Procedure:**

1. Set the multimeter to measure continuity. The resistance measurement setting can also be used.
2. Check for continuity by measuring from pin 1 on one end of the cable to pin 1 on the other end. The meter should confirm that the connection is continuous by either giving an audible signal or measuring a low resistance. If there is not continuity, there is a break in the cable, which will require repair.
3. Repeat step 2 for all pins in the cable.
4. Check for shorts from pin 1 to all other pins by keeping one probe lead on pin 1 and touching the other probe lead to each of the other pins in the same connector in turn. Repeat this for all pins on the cable to make sure that all the pins are isolated from each other. The meter should read this as open or measure a very high resistance. If any of the pins are not isolated, there is a short in the cable, which will require repair.

	SYSTEM	<b>Profiler II Ocean Profiler</b>
	SECTION	<b>G - CONFIGURATION</b>

## G - CONFIGURATION

Your Profiler II has been pre-configured by Satlantic with standard configuration parameters. These parameters control many aspects of the instruments operation to account for the wide variety of applications in which Profiler II instruments are used. In addition to the operating modes described in section **D - OPERATION**, a configuration mode is also available to modify configuration parameters and test various systems of the instrument. This configuration mode is implemented by the instrument's **Command Console**.

In most cases, the command console would be accessed using a terminal emulation program. Terminal emulators are used in many applications involving serial communications, internet mail and news services, telnet and ftp services, etc. For communication with your Profiler II, you will need to make a direct connection to the serial port hosting the instrument. Connect the instrument using the RS-232 telemetry interface. You cannot use the RS-422 interface, as it is transmit-only (unless your instrument has been configured for full-duplex RS-422 communications). For communications software, use your favorite terminal emulator (Windows<sup>®</sup> comes with one called HyperTerminal<sup>®7</sup>). Ensure that the serial connection to the instrument is at the *telemetry baud rate*. Use any ANSI or ANSI-compliant (i.e. VT-xxx) emulation. While operating in this mode, your Profiler II uses simple character I/O with no control character interpretation. Therefore, most terminal emulators will do.

The command console can be accessed at any point during the instruments operation. You can even access the command console of a remote or networked instrument through the Network Master. Methods for accessing the console are described in section **D - OPERATION**.

**IMPORTANT!** This section goes into great detail about the SatNet aspect of the Profiler II, and is intended for advanced users only. Most users will not require any knowledge of this system, as the instrument is essentially a “plug and play” device when used with SatView. Changing any parameters will affect system operation – please discuss any changes with a Satlantic representative before modifying these settings.

### Command Console

The Profiler II command console was designed to resemble an MS-DOS<sup>®</sup> or UNIX<sup>®</sup> command prompt<sup>8</sup>. Although the actual functionality of the console is quite removed from these systems (it is far simpler), the basic design lends a certain degree of familiarity. When the console is first invoked, you will see a prompt on your terminal emulator screen similar to the one shown below:

```
MicroPro Profiler 2 Command Console
Type 'help' for a list of available commands.

[Master:001]$
```

<sup>7</sup> See APPENDIX A for more information on using HyperTerminal. HyperTerminal is a registered trademark of Microsoft Corporation.

<sup>8</sup> MS-DOS and UNIX are registered trademarks of Microsoft Corporation and Sun Microsystems Corporation respectively.

 <b>Operation Manual</b>	SYSTEM	<b>Profiler II Ocean Profiler</b>
	SECTION	<b>G - CONFIGURATION</b>

The first two lines are the command prompt header. They are not repeated unless you reset the console. The first line indicates the type of instrument for which the console is being used. The next line helps new users to get acquainted with the system.

The actual command prompt ends with the “\$” character. The characters between the [ ] brackets provide information on the operating mode of the instrument. In the example above, “Master” indicates that the instrument is running in Network Master mode. The numbers following the “:” character is the three-digit network address for the Profiler II. If the instrument is running in network mode, which means the command console was accessed through the Network Master, the command prompt will look something like this:

```
[Remote:001]$
```

The “Remote” keyword indicates that the command prompt is for a remote or networked instrument. The numbers following the “:” character is the three-digit network address of the remote instrument. This gives the user the ability to quickly differentiate one remote instrument from another. In Autonomous mode, the prompt would simply show “[Autonomous]\$”.

Using the command prompt is quite simple. Type in a command at the prompt followed by the <Enter> key. This will execute the command, displaying the results to the screen, if any. You can easily edit commands if you make a mistake. Use the <Backspace> key to delete characters in your command before you execute them. You can even recall the last executed command by pressing the <Esc> key on a clear command prompt. This is handy if you are repeatedly executing the same or similar commands.

The command console interprets all commands as case sensitive. This means that the command “exit” is different from “EXIT”. Most commands require small case letters.

 <b>Operation Manual</b>	SYSTEM	<b>Profiler II Ocean Profiler</b>
	SECTION	<b>G - CONFIGURATION</b>

If this is your first time using the command console, a good starting point is the “help” command. As you probably noticed, the command prompt header suggests this command for novice users. Executing this command will display the following text:

The following console commands are available for this instrument:

```

reset      Resets the command console.
id         Displays the instrument identification banner.
power     Turns operational power on and off.
set       Sets the instrument's configuration parameters.
show     Shows the instrument's configuration parameters.
save     Saves the instrument's configuration parameters.
ping     Pings the network for remote instrument(s).
remote   Engages the command console of a remote instrument.
query    Queries the external sensor A/D converter.
sample   Takes a test sample of all A/D channels.
vout     Turns external device power on and off.
sd1test  Tests telemetry on port 1.
Sd2test  Tests telemetry on port 2.
exit     Exits the command console.
exit!    Exits the command console and resets
         the instrument.

```

For more information on individual commands, type ‘-?’ after the command.

All commands available to the instrument are listed on the left, with descriptions on the right. For the most part, these descriptions adequately define the purpose of each command. However, some commands are more complex and require a little more than a simple one-word entry. As indicated above, you can type a “-?” after a command to display additional help information. Make sure there is a space between the command and the “-?” parameter. If there is additional help available for the command, the text will be displayed. Otherwise, a message indicating, “No more help is available.” will be displayed.

Some commands require additional command line parameters. Executing one of these commands with missing or incorrect parameters will display a “Usage:” message. This is helpful in determining what parameters are acceptable for a particular command and how they should be formatted. For example, if you executed the “power” command without any parameters, the following message would be displayed:

```
Usage: power [operational power (on|off|?)]
```

This command requires one parameter, as indicated by the contents of the [ ] brackets. If the command required more than one parameter, additional sets of [ ] brackets with their parameter descriptions would be displayed. Parameters must always be separated by a space. Within the [ ] brackets is a description of the parameter followed by the list of acceptable parameter values, contained in the ( ) brackets. The values listed here are always separated by the “|” character. In

 <b>Operation Manual</b>	SYSTEM	<b>Profiler II Ocean Profiler</b>
	SECTION	<b>G - CONFIGURATION</b>

this case, there are three accepted forms of this command; “power on”, “power off”, and “power ?”.

Generally, the usage of the command console is self-explanatory. It should only take you a few moments to get a working knowledge of the system. Although the on-line help is fairly extensive, some commands need more detailed explanations that would be too cumbersome to include in the instrument itself. The following sections describe each command in more detail.

### RESET COMMAND

The “reset” command resets the console, redisplaying the command prompt header described above. Any configuration parameters modified during the console session that were not saved will revert back to their previous values. This command requires no additional command line parameters.

### ID COMMAND

The “id” command displays the identification banner for the instrument, as shown is the following example:

```
Satlantic MicroPro Profiler 2
Copyright (C) 2002, Satlantic Inc. All rights reserved.
Firmware version: 1.1A(P), 1.1A(S) - SatNet Type A
Instrument: SATMPR
S/N: 0054
```

The identification banner is also part of the start-up banner, which is displayed during the initialization sequence described in section **D - OPERATION**. This command requires no additional command line parameters.

### POWER COMMAND

The “power” command may be used to turn operational power on and off during a command console session. Operational power supplies electronic components in the instrument responsible for sensor data acquisition. Powering down these components will reduce the instruments total power consumption, but you will no longer be able to obtain ancillary data. The instrument is otherwise fully operational, so communication is still possible. When operational components are powered down, sensor data acquisition is disabled.

This command requires one command line parameter. To turn on operational power, use the “power on” command. To turn off operational power, use the “power off” command. To query the operational power status, use the “power ?” command. This will display a message similar to the one below:

```
Operational Power: on
```

<b>IMPORTANT! Operational power will remain in the state set by this command once the command console exits and normal operation resumes.</b>
---

 <b>Operation Manual</b>	SYSTEM	<b>Profiler II Ocean Profiler</b>
	SECTION	<b>G - CONFIGURATION</b>

## SET COMMAND

The “set” command modifies configuration parameters for the instrument. These parameters affect various aspects of the instruments operation and can be modified by the user to customize the instrument. For a Profiler II, if you enter a “set -?” command, the following will be displayed:

```
Usage: set [parameter] [value]

set telbaud [telemetry baud rate (bps)]
set maxrate [maximum frame rate (Hz)]
set initsm [initialize silent mode (on|off)]
set initpd [initialize power down (on|off)]
set initat [initialize auto telemetry (on|off)]
set netmode [network mode (on|off)]
set netadd [network address (1-255)]
set netbaud [network baud rate (bps)]
set master [network master (on|off)]
set mct [master controlled telemetry (on|off)]
set bias [master network bias (on|off)]

set vout [initialize external power (on|off)]
set sd1 [instrument (1-18 chars)]
set sdbaund [telemetry baud rate (bps)]
set sdlenable [serial device 1 telemetry enable (on|off)]
set sd2 [instrument (1-18 chars)]
set sd2baund [telemetry baud rate (bps)]
set sd2enable [serial device 2 telemetry enable (on|off)]
```

This command requires two command line parameters. The first parameter specifies the configuration parameter to modify. The second specifies the new value to assign to the parameter. A list of all available configuration parameters is shown above.

**IMPORTANT! Be careful using this feature. Changes made to the Profiler II configuration parameters affect the way the instrument operates. Before you modify any of configuration parameters, make sure you understand the consequences of the change.**

For more information on these parameters and their affect on your instruments operation, see section *Profiler II Configuration* Parameters below.

## SHOW COMMAND

The “show” command displays configuration parameters for the instrument. These parameters are modified by the “set” command explained above. If you enter “show -?” at the command prompt, the following message will be displayed:

```
Usage: show [parameter|all]
```

	SYSTEM	<b>Profiler II Ocean Profiler</b>
	SECTION	<b>G - CONFIGURATION</b>

See help for the 'set' command for a list of available parameters.

This command requires only one command line parameter, which is the same as the first parameter of the "set" command. Using the "show" command in this way displays the current value of the configuration parameter, even if it has not yet been saved. You may also use "all" as the command line parameter to show a complete list of all configuration parameters and their current values. For example, using the "show all" command on you Profiler II would display something like this:

```
Telemetry Baud Rate: 57600 bps
Maximum Frame Rate: 10
Initialize Silent Mode: off
Initialize Power Down: off
Initialize Automatic Telemetry: on
Network Mode: on
Network Address: 001
Network Baud Rate: 38400 bps
Network Master Mode: on
Master Controlled Telemetry: off
Master Network bias: on
```

```
Initialize external power: on
```

```
Use 'show sduino' for serial devices
```

Note that configuration information on the foreign sensors can be displayed with the "show sduino" command. Typing this command will yield a display similar to the following, depending on your system configuration:

```
Serial Device on Port 1: SATBB2F086
Serial Device 1 baudrate: 19200
Serial Device 1 telemetry: on
Serial Device on Port 2: unknown
Serial Device 2 baudrate: 19200
Serial Device 2 telemetry: off
```

This display would be typical of a Profiler II system with a single foreign sensor connected to port 1, with telemetry enabled and operating at a baud rate of 19200 bps. In this case, the foreign sensor is a WET Labs ECO-BB2F, S/N 086. The Profiler II will place a header, which we have defined to be "SATBB2F086", in front of the ECO-BB2F's data. This allows Satlantic to generate a calibration file for the instrument and use it with our data acquisition software.

For more information on these parameters and their affect on your instruments operation, see section **Profiler II Configuration** Parameters below.



 <b>Operation Manual</b>	SYSTEM	<b>Profiler II Ocean Profiler</b>
	SECTION	<b>G - CONFIGURATION</b>

## SAVE COMMAND

Modifying configuration parameters with the “set” command does not necessarily mean that those parameters will be retained for use in the next session with the instrument. When the “save” command is issued, all configuration parameters are placed in persistent storage inside the instrument. If these parameters are not saved once they are modified, all changes will be lost when the command console exits or power is removed from the instrument.

The “save” command requires no additional command line parameters. Once the command is issued, it cannot be undone.

**IMPORTANT! Once the instruments configuration parameters have been saved, the instrument must be reset before normal operation can resume. Usually it is best to remove power for a few seconds to ensure all instruments reboot.**

## PING COMMAND

The “ping” command is only available to network master instruments. It can be used to test the presence of slave devices on the network, and to determine their network addresses.

If you enter “ping -?” at the command prompt, the following message will be displayed:

```
Usage: ping [network address (1-255|all)]
```

```
Use this command to ping a network address. If an instrument is present, it's identification will be displayed.
```

This command requires only one command line parameter, either a known network slave address (1-255) or “all”. For example, if you wish to ping the instrument at address 100, you would enter “ping 100” and receive a response similar to the following:

```
100> Instrument: SATDI7 - S/N: 0045
```

if an instrument is present at that address. If not, you will receive a “No response” message.

Using “all” as the command line parameter will send a global ping command to all slaves on the network. For example, issuing a “ping all” command from the command console would give a response similar to the following:

```
010> Instrument: SATDI7 - S/N: 0044
020> Instrument: SATDR7 - S/N: 0044
100> Instrument: SATDI7 - S/N: 0045
200> Instrument: SATDR7 - S/N: 0045
```

The exact response will of course depend on your instrument configuration.

 <b>Operation Manual</b>	SYSTEM	<b>Profiler II Ocean Profiler</b>
	SECTION	<b>G - CONFIGURATION</b>

Note: occasionally, slave sensors may not respond to the “ping all” command properly; you may have to issue the command several times to determine all the slaves on the network.

## REMOTE COMMAND

The “remote” command is only available to network master instruments. It can be used connect directly to a remote network slave’s command console through the network. In order to connect to the remote slave, its network address must be known – this can be determined using the “ping all” command explained above. Note that the term “remote” does not imply a distantly located instrument, only that it is a instrument other than the network master.

If you enter “remote -?” at the command prompt, the following message will be displayed:

```
Usage: remote [network address (1-255)]
```

```
Use this command to engage the command console of a networked instrument. The command prompt will indicate the address of the remote (or networked) instrument.
```

This command requires only one command line parameter – a known remote instrument address. For example, to connect to an instrument at remote address 100, enter “remote 100”. Assuming that address is in use and that the instrument is an OCR-507, the following message would be displayed:

```
OCR-507 Command Console
Type 'help' for a list of available commands.
```

```
[Remote:100]$
```

You are now indirectly connected to the remote instrument’s command console at the specified network instrument. Any command normally accessible from the slave’s telemetry interface is now accessible through the network master. This capability is very useful for troubleshooting and for changing operational parameters for the slave, as a direct connection to the slave is not required. Be careful what settings you change on the remote instrument!

To return to the network master’s command console, simply enter the ‘exit’ command.

## QUERY COMMAND

The “query” command is a debugging command that is generally only useful to Satlantic staff, but is detailed here for completeness. Issuing this command returns various settings from the ancillary sensor’s A/D. If you enter this command, you will get a response similar to the following:

```
CR:      04E1
CCR1:    F090B0D0
CCR2:    70103050
```

 <b>Operation Manual</b>	SYSTEM	<b>Profiler II Ocean Profiler</b>
	SECTION	<b>G - CONFIGURATION</b>

```
OFS:
    40 3E 00 40 3E 00
    40 3E 00 40 3E 00
    40 3E 00 40 3E 00
    40 3E 00 40 3E 00
```

```
+SF:
    20 00 00 20 00 00
    20 00 00 20 00 00
    20 00 00 20 00 00
    20 00 00 20 00 00
```

```
-SF:
    DF FF FF DF FF FF
    DF FF FF DF FF FF
    DF FF FF DF FF FF
    DF FF FF DF FF FF
```

### SAMPLE COMMAND

The “sample” command can be used to test the operation of all sensors on board the instrument (but not slave sensors). This may be helpful in diagnosing problems with any of the instrument’s sensors if some kind of abnormality occurs. Before using this command, make sure operational power has been applied.

When a sensor is sampled by this command, its value is displayed in hexadecimal format. This value is simply the number of counts measured by the sensor’s Analog-to-Digital converter. These values do not represent sensor output in physical units.

This command requires no additional command line parameter – all available measurements are made. Using the “sample” command will display something similar to the following:

```
External sensor A/D converter test sample:
```

```
1: 7FF5
2: 7FFE
3: 7FF6
4: 8001
5: 8004
6: 8000
7: 8001
8: 0D56
```

```
VIN test sample:          0192 (12.06 V)
VA test sample:           00A7 (5.01 V)
V15 test sample:          01F8 (15.12 V)
V6 test sample:           00C8 (6.00 V)
Int. temp. test sample:   0099 (26.50 C)
```

VIN is the internal power rail and should measure approximately 12 V. VA is the main analog rail, and should measure 5 V. V15 is the 15 V rail used by the

 <b>Operation Manual</b>	SYSTEM	<b>Profiler II Ocean Profiler</b>
	SECTION	<b>G - CONFIGURATION</b>

pressure sensor. V6 is the 6V rail used by the conductivity and temperature sensor. The final sensor gives a measure of the temperature on the control electronics, and is usually several degrees higher than room temperature.

### **VOUT COMMAND**

The “vout” command is a Profiler II command that allows the user to turn power to the external instruments on and off. This command is normally useful only as a test feature. **Please note that in some Profiler II systems, vout (+12V) may be always on – this command may have no effect.**

Entering the “vout” command without any parameters will display its usage:

```
Usage: vout [external power (on|off|?)]
```

As can be seen, this command accepts three command line parameters. Using the “on” parameter forces the external power to turn on, while using the “off” parameter turns it off. The “?” parameter returns the current state of the external power.

### **SD1TEST AND SD2TEST COMMANDS**

The “sd1test” and “sd2test” commands are Profiler II specific commands that allow the user to test telemetry on foreign sensor ports 1 and 2 respectively. For example, entering “sd1test” will attempt to retrieve a complete frame of data from the instrument connected to port 1 – if successful, it will display the data frame. If, after several seconds, no data is received, a “No response from the Proxy controller” message will be issued.

### **EXIT AND EXIT! COMMANDS**

The “exit” and “exit!” commands end the current command console session. Once the console exits, normal operation will resume in most cases. Otherwise, the instrument will reset itself before normal operation can begin. The only difference between the two versions of this command is that the “exit!” command forces a reset of the instrument, even if it isn’t necessary.

There are two conditions that will cause the instrument to reset itself. One or both conditions must exist for this to occur. These conditions are:

1. The command console was invoked during the initialization sequence.
2. Configuration parameters have been modified and saved.

If you attempt to exit the console with modified configuration parameters that have not been saved, the following dialog will be presented:

```
The configuration parameters have been modified.
Save changes [y/n]?
```

 <b>Operation Manual</b>	SYSTEM	<b>Profiler II Ocean Profiler</b>
	SECTION	<b>G - CONFIGURATION</b>

Choose “y” for yes or “n” for no to answer this question. If you choose yes, the configuration parameters will be saved and the instrument will reset itself. Otherwise, any modifications to the configuration parameters will be lost. See the **Save Command** section above for more information on saving configuration parameters.

### **Profiler II Configuration Parameters**

This section describes, in detail, the function of each configuration parameter used by the Profiler II. The title of each section identifies the name of the parameter, as displayed by the “show” command. Also clearly identified in each section is the command line parameter keyword used in both the “set” and “show” commands.

See the descriptions of the “set” and “show” commands described in the **Command Console** section above for more information.

#### **TELEMETRY BAUD RATE**

**Command Line Parameter:** telbaud

The telemetry baud rate defines the speed at which data is transferred on the telemetry interface. This should not be confused with the frame rate. Baud rates are specified in units of *bits per second* (bps). Any data acquisition or terminal emulation software must be configured to communicate with the instrument at this baud rate. Only certain standard parameter values are accepted, as shown in the table below:

<b>Baud Rate (bps)</b>
9600
19200
38400
57600
115200

When modifying this parameter with the “set” command, you must enter at least the first two digits of one of these baud rates as the value parameter.

Ideally, you would want the telemetry interface to run at the fastest baud rate available. However, certain restrictions, like cable quality or excessively long transmission mediums, may require a reduction in the telemetry baud rate. The data acquisition computer and/or software may also impose restrictions.

#### **MAXIMUM FRAME RATE**

**Command Line Parameter:** maxrate

 <b>Operation Manual</b>	SYSTEM	<b>Profiler II Ocean Profiler</b>
	SECTION	<b>G - CONFIGURATION</b>

This parameter allows you to define the maximum frame rate that the instrument will use during normal operation with free-running telemetry output. The frame rate defines how often a frame of telemetry is composed and transmitted. If the instrument is running autonomously (autonomous operation), frames are transmitted through the telemetry interface. If the instrument is operating in network mode (network operation), these frames are transmitted through the network interface. However, the Network Master can be configured to override the frame rates of all other instruments using the *master controlled telemetry (mct)* option.

Frame rates are specified in units of *frames per second* or *Hertz (Hz)*. There are several factors involved in determining how quickly the instrument can transmit frames. On-board electronics, such as the Analog-to-Digital converter used to sample each sensor, may limit how fast a telemetry frame can be composed. Configuration parameters like the telemetry and/or network baud rates are important in determining how quickly one frame can be transmitted before the next. While in network operation, saturation of the Network Master's telemetry interface, caused by too many networked instruments broadcasting their telemetry at the same time, may slow down the frame rate of some or all instruments in the system. Therefore, the actual frame rate realized during normal operation cannot be any faster than the limitations imposed by these conditions. Some of these factors may vary during normal operation, making the determination of a constant frame rate impossible. Providing a maximum frame rate slower than what the instrument is capable of providing will help pace the output of each frame evenly. Generally, a Profiler II frame rate of 10 Hz is a good setting.

Only certain standard frame rates are accepted by this parameter, as shown in the table below:

Frame Rate (Hz)
0.125
0.25
0.5
1
2
4
8
10
12
0 (AUTO)

 <b>Operation Manual</b>	SYSTEM	<b>Profiler II Ocean Profiler</b>
	SECTION	<b>G - CONFIGURATION</b>

When modifying this parameter with the “set” command, you must enter one of these numbers as the value parameter. Any numerical values that are in between the values in the table will be rounded up to the nearest standard frame rate. To specify an automatic (AUTO) frame rate, input “0” as the value parameter. This will cause the instrument to output frames as fast as possible.

Specifying a frame rate faster than is practically possible will not force the actual frame rate to that level. The instrument will only transmit as fast as possible for the given operating parameters. This is essentially the same as specifying an AUTO frame rate. In addition, frames are always transmitted as a whole as much as possible. Once a frame starts transmitting, it is transmitted continuously until the frame is completely output. Specifying a frame rate of, for example, 0.5 Hz does not mean that half a frame is transmitted every second. It means that every two seconds, a frame will begin transmitting.

### INITIALIZE SILENT MODE

**Command Line Parameter:**    `initsm`

Normally, just after the instrument is powered up or reset, a start-up banner will be output on the telemetry interface during the initialization sequence. The messages in this banner, among other things, identify the instrument and provide a copyright notification. If silent mode is enabled, this banner will not be displayed. This ensures that no data will be transmitted on the telemetry interface until, if running autonomously, normal operation begins and telemetry output is available. Enabling silent mode does not mean that the telemetry interface is disabled during initialization. The command console can still be engaged. See section **D - OPERATION** for more information on the start-up banner and the initialization sequence.

When modifying this parameter with the “set” command, you must enter either “on” or “off” as the value parameter to enable or disable silent mode.

### INITIALIZE POWER DOWN

**Command Line Parameter:**    `initpd`

Near the end of the initialization sequence, operational power is normally applied. However, the instrument can be configured to boot into a power savings mode. With the initialize power down parameter enabled, operational power will not be applied during initialization. This means that telemetry output will be disabled when normal operation begins. See section **D - OPERATION** for more information on the initialization sequence.

When modifying this parameter with the “set” command, you must enter either “on” or “off” as the value parameter to enable or disable the power savings mode.

### INITIALIZE AUTOMATIC TELEMETRY

**Command Line Parameter:**    `initat`

 <b>Operation Manual</b>	SYSTEM	<b>Profiler II Ocean Profiler</b>
	SECTION	<b>G - CONFIGURATION</b>

For instruments running in autonomous operation only, the telemetry output mode can be configured to start as free-running or polled once normal operation begins. This means that once normal operation has begun and this parameter is disabled (polled operation), telemetry output will not occur unless the instrument is polled with the <Enter> or <Space> key commands. Otherwise, telemetry output will be free-running in accordance with the maximum frame rate configuration parameter. Of course, if operational power is not applied, telemetry output is disabled altogether regardless of this parameter. See **Autonomous Operation** in section **D - OPERATION** for more information on telemetry output modes.

When modifying this parameter with the “set” command, you must enter either “on” or “off” as the value parameter to enable or disable automatic telemetry.

## NETWORK MODE

**Command Line Parameter:** netmode

This parameter enables or disables network operation for the instrument. Although disabling this parameter will force the instrument to run autonomously, enabling it does not necessarily mean network operation will be invoked. The instruments operating mode is determined during the initialization sequence. See **Network Operation** in section **D - OPERATION** for more information.

When modifying this parameter with the “set” command, you must enter either “on” or “off” as the value parameter to enable or disable network operation.

## NETWORK ADDRESS

**Command Line Parameter:** netadd

The network address uniquely identifies an instrument on a network. All network transmissions use this parameter to identify the sender and receiver of the message. It is not important what value is assigned to the network address, as long as it is unique from other instruments in the network.

**IMPORTANT! Make sure that each device on the network, including the Network Master, has a unique network address. If two or more devices have the same address, contentions may result and data could be lost.**

When modifying this parameter with the “set” command, you must enter an integer from 1 to 255 inclusive as the value parameter.



 <b>Operation Manual</b>	SYSTEM	<b>Profiler II Ocean Profiler</b>
	SECTION	<b>G - CONFIGURATION</b>

## NETWORK BAUD RATE

**Command Line Parameter:** `netbaud`

The network baud rate defines the speed at which data is transferred on the network interface. Baud rates are specified in units of *bits per second* (bps). Only certain standard parameter values are accepted, as shown in the table below:

Baud Rate (bps)
9600
14400
19200
28800
38400
57600
76800

When modifying this parameter with the “set” command, you must enter at least the first two digits of one of these baud rates as the value parameter.

**IMPORTANT! Make sure that each device on the network, including the Network Master, is operating with the same network baud rate. Any devices in the network running at a baud rate different from the Network Master will be ignored.**

Ideally, you would want to run the network at the fastest baud rate available. However, certain restrictions, like cable quality or excessively long transmission mediums, may require a reduction in the network baud rate.

## NETWORK MASTER MODE

**Command line parameter:** `master`

The network master mode setting determines whether or not the instrument will act as a network master.

**IMPORTANT! In most Profiler II systems, the profiler must be the network master.**

When modifying this parameter with the “set” command, you must enter either “on” or “off” as the parameter value to enable or disable network master mode.

 <b>Operation Manual</b>	SYSTEM	<b>Profiler II Ocean Profiler</b>
	SECTION	<b>G - CONFIGURATION</b>

## MASTER CONTROLLED TELEMETRY

**Command line parameter:**    `mct`

The master controlled telemetry setting determines whether or not the master controls the frame rate of the slave instruments. In a typical SatNet environment, slaves are allowed to “free-run”, outputting telemetry when it is available. However, the master device can force its frame rate onto the slave devices by enabling this parameter.

**IMPORTANT! Slave devices may not be able to update their frames as fast as the network master. In this instance the mct parameter will have no effect.**

When modifying this parameter with the “set” command, you must enter either “on” or “off” as the parameter value to enable or disable master controlled telemetry.

## MASTER NETWORK BIAS

**Command line parameter:**    `bias`

The master network bias setting determines whether or not the instrument enables its network biasing circuitry.

**IMPORTANT! The network bias circuitry must be enabled for normal network operation.**

The basic rule of thumb is that if a device is configured as a Network Master, its bias circuit must be enabled. If the device is configured as a slave, the bias circuit must be disabled.

When modifying this parameter with the “set” command, you must enter either “on” or “off” as the parameter value to enable or disable the bias circuitry.

	SYSTEM	<b>Profiler II Ocean Profiler</b>
	SECTION	<b>G - CONFIGURATION</b>

## INITIALIZE EXTERNAL POWER

**Command line parameter:**    `vout`

The initialize external power setting determines whether or not the instrument turns on power to the external slave devices at start-up (unless power is permanently enabled in hardware).

**IMPORTANT! The external slaves may not operate if this parameter is disabled.**

When modifying this parameter with the “set” command, you must enter either “on” or “off” as the parameter value to enable or disable output power at start-up.

## FOREIGN DEVICE HEADERS

**Command line parameter:**    `sd1` or `sd2`

The foreign device (or *serial device*) header setting defines the unique ASCII header that the Profiler II will place on data received from the non-Satlantic device connected to ports 1 and 2. Using a unique header allows Satlantic software to log the data correctly, as in a SatNet system there may be data from many different instruments on the same communications port.

**IMORTANT! The sd1 and sd2 headers must be the same as defined in the device(s) Satlantic calibration file, or SatView will not log telemetry from the devices. The sd1 header must be different than the sd2 header.**

These settings are normally generated at Satlantic, although it is possible for the user to add a foreign device to the instrument if care is taken. Please contact Satlantic for assistance.

To change the sd1 or sd2 header value with the “set” command, simply enter the desired header after the “set `sdx`” command. For instance, Satlantic would define a WET Labs ECO-BB2F s/n 086 connected to port 1 as “set `sd1 SATBB2F086`”. Satlantic normally creates headers with the first 3 letters as “SAT” as use it as a global sync string in SatView. “BB2f086” obviously indicates the WET Labs device and serial number, making a very unique synchronization string. The header string must be 20 characters or less.

The default value for the sd1/sd2 setting is “unknown”.

 <b>Operation Manual</b>	SYSTEM	<b>Profiler II Ocean Profiler</b>
	SECTION	<b>G - CONFIGURATION</b>

## FOREIGN DEVICE BAUD RATE

**Command Line Parameter:** `sd1baud` or `sd2baud`

The foreign device baud rate defines the speed at which data is transferred on the foreign device telemetry interfaces (port 1 and port 2). This should not be confused with the frame rate. Baud rates are specified in units of *bits per second* (bps). Only certain standard parameter values are accepted, as shown in the table below:

Baud Rate (bps)
2400
4800
9600
19200
38400
57600
115200

When modifying this parameter with the “set” command, you must enter at least the first two digits of one of these baud rates as the value parameter. For example, to set port 1 to 19200 bps, use “set `sd1baud 19200`”.

**If the baud rate setting does not match the devices actual baud rate, the Profiler II will be unable to obtain its data.** The baud rate for the device can be determined from its associated documentation. The default setting for each port is 19200 bps.

## FOREIGN DEVICE TELEMETRY ENABLE

**Command line parameter:** `sd1enable` or `sd2enable`

The foreign device telemetry enable setting determines whether or not the instrument allows telemetry from the foreign device to be transmitted at start-up.

**IMPORTANT! You will not obtain telemetry from the foreign device if this setting is not enabled.**

When modifying this parameter with the “set” command, you must enter either “on” or “off” as the parameter value to enable or disable output power at start-up. The default setting is off.

	SYSTEM	<b>Profiler II Ocean Profiler</b>
	SECTION	<b>H - WARRANTY</b>

## **H - WARRANTY**

### ***Warranty Period***

All Satlantic equipment is covered under a one-year parts and labor warranty from date of purchase.

### ***Restrictions***

Warranty does not apply to products that are deemed by Satlantic to be damaged by misuse, abuse, accident, or modifications by the customer. The warranty is considered void if any optical or mechanical housing is opened. In addition, the warranty is void if the warranty seal is removed, broken or otherwise damaged.

### ***Provisions***

During the one year from date of purchase warranty period, Satlantic will replace or repair, as deemed necessary, components that are defective, except as noted above, without charge to the customer. This warranty does not include shipping charges to and from Satlantic.

### ***Returns***

To return products to Satlantic, whether under warranty or not, contact the Satlantic Customer Support Department and request a Returned Material Authorization (RMA) number and provide shipping details. All claims under warranty must be made promptly after occurrence of circumstances giving rise thereto and must be received by Satlantic within the applicable warranty period. Such claims should state clearly the product serial number, date of purchase (and proof thereof) and a full description of the circumstances giving rise to the claim. All replacement parts and/or products covered under the warranty period become the property of Satlantic Inc.

### ***Liability***

IF SATLANTIC EQUIPMENT SHOULD BE DEFECTIVE OR FAIL TO BE IN GOOD WORKING ORDER THE CUSTOMER'S SOLE REMEDY SHALL BE REPAIR OR REPLACEMENT AS STATED ABOVE. IN NO EVENT WILL SATLANTIC INC. BE LIABLE FOR ANY DAMAGES, INCLUDING LOSS OF PROFITS, LOSS OF SAVINGS OR OTHER INCIDENTAL OR CONSEQUENTIAL DAMAGES ARISING FROM THE USE OR INABILITY TO USE THE EQUIPMENT OR COMPONENTS THEREOF.

	SYSTEM	<b>Profiler II Ocean Profiler</b>
	SECTION	<b>I – CONTACT INFORMATION</b>

## I - CONTACT INFORMATION

If you have any problems, questions, suggestions, or comments about the instrument or manual, please contact us.

### *Location*

#### **Satlantic Inc.**

3481 North Marginal Road  
Halifax, Nova Scotia  
B3K 5X8 Canada

PHONE: (902) 492-4780

FAX: (902) 492-4781.

Email: Technical Support: [support@satlantic.com](mailto:support@satlantic.com)

General Inquiries: [info@satlantic.com](mailto:info@satlantic.com)

Web: <http://www.satlantic.com>

### *Business Hours*

Satlantic is normally open for business between the hours of 9 AM and 5 PM Atlantic Time. Atlantic Time is one hour ahead of Eastern Time. Daylight saving time is in effect from 2:00 a.m. on the second Sunday in March through 2:00 a.m. on the first Sunday in November. Atlantic Standard Time (AST) is UTC-4. Atlantic Daylight Saving Time (ADT) is UTC-3.

Satlantic is not open for business during Canada's statutory holidays, which are as follows:

New Year's Day	January 1st
Good Friday	The Friday before Easter Sunday (Easter Sunday is the first Sunday after the full moon on or following March 21 <sup>st</sup> , or one week later if the full moon falls on Sunday)
Victoria Day	The first Monday before May 25 <sup>th</sup>
Canada Day	July 1 <sup>st</sup>
Halifax Natal Day	The first Monday in August
Labor Day	The first Monday in September
Thanksgiving Day	The second Monday in October
Remembrance Day	November 11 <sup>th</sup>
Christmas Day	December 25 <sup>th</sup>
Boxing Day	December 26 <sup>th</sup>

 <b>Operation Manual</b>	SYSTEM	<b>Profiler II Ocean Profiler</b>
	SECTION	<b>J – MANUAL REVISION</b>

## J - MANUAL REVISIONS

Date	Author	Rev.	Comments
2003-09-18	SKF	A	Initial release.
2006-09-21	VMD	B	Deployment section update.
2006-11-07	RVD	C	CT sensor updates.
2006-12-14	KMB	D	Minor formatting, re-ordered sections, addition of list of acronyms.
2007-05-01	KMB	E	Warranty statement.
2008-02-12	RVD	F	Removed 'Upwelling Radiance and Downwelling Irradiance' figure.
2008-06-10	KMB	G	Pressure Tare procedure. Surface mode float.
2008-09-15	SDM	I	Add description of multicast. Add description of sensor distances for new factory defaults to match ProSoft 8.0.

	SYSTEM	<b>Profiler II Ocean Profiler</b>
	SECTION	<b>K – APPENDIX A</b>

## K - APPENDIX A

### *Using Windows® HyperTerminal*

Most Satlantic instrumentation uses serial communications for interfacing with the outside world. This type of interface is simple to operate and convenient for applications such as these. Although the instruments telemetry interface is used mainly for broadcasting telemetry, it can also be used to establish a user interface so you may configure and test the instruments systems. To use this interface, or to monitor instrument telemetry directly, you will need a terminal emulation program. These programs have many common uses such as communicating with bulletin board services, remotely logging on to other computers on a network, or communicating directly with your modem. You can also use it for direct communications with a serial port, which is ideal for communicating with Satlantic instruments.

There are many types of terminal emulation programs. Most of these are suitable for this application, so you are free to use whatever terminal emulator you are comfortable with. If you are unfamiliar with terminal emulators, this tutorial will help you get started with the emulator program that is distributed with Windows® called *HyperTerminal*.

The first step in using HyperTerminal is to make sure you have it installed. One way of starting the application is to use the **Start** button on your desktop. Select **“Run...”** and type “hypertrm” in the space provided. If the program cannot be found, it has probably not been installed. You can also check for a HyperTerminal installation by selecting **Start -> Programs -> Accessories**. If a **HyperTerminal** folder is visible in the **Accessories** folder, HyperTerminal is already installed.

If HyperTerminal is not installed, it is an easy matter to install it now. In Windows 95/98, open the Control Panel by selecting **Start -> Control Panel**. Open the **Add/Remove Programs** control. When you have setup these dialog boxes as shown below, press the OK button in each one. Windows will now install HyperTerminal on your computer. You may need your Windows Setup Disks/CD for this to complete. Just follow the on-screen instructions.



 <b>Operation Manual</b>	SYSTEM	<b>Profiler II Ocean Profiler</b>
	SECTION	<b>K – APPENDIX A</b>

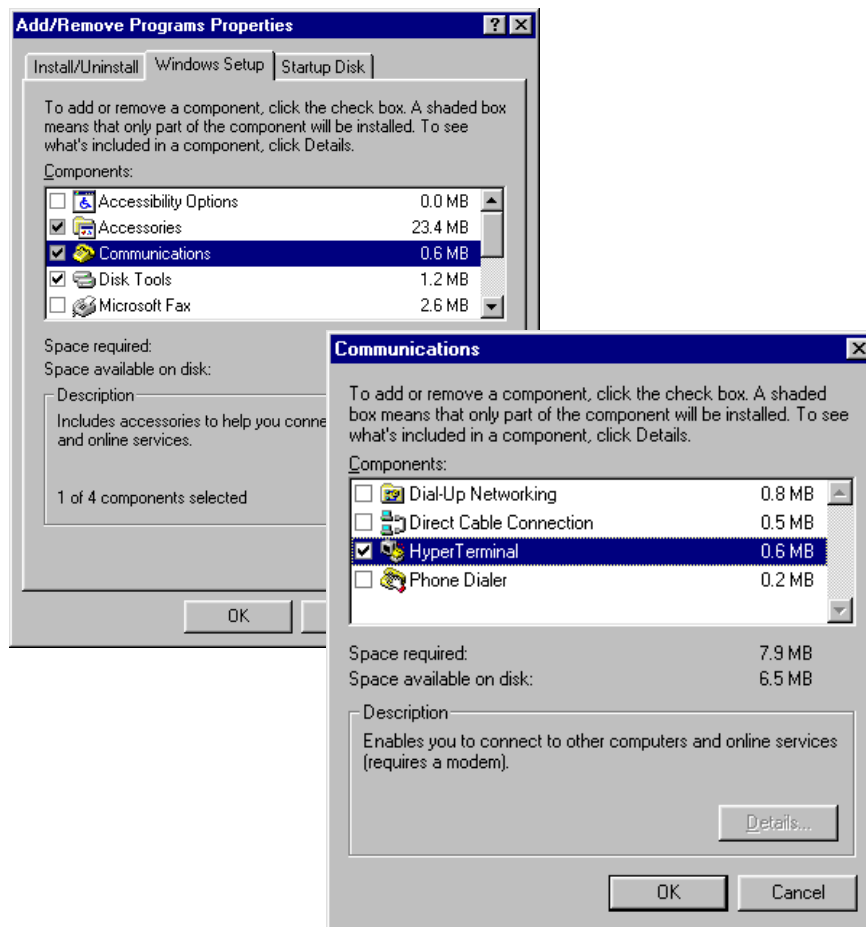

*Figure K-1: Add/Remove Programs*

When you run HyperTerminal with a new connection, the program will ask you for connection information so it can be saved for your next session. You should see the following dialog box.

	SYSTEM	<b>Profiler II Ocean Profiler</b>
	SECTION	<b>K – APPENDIX A</b>

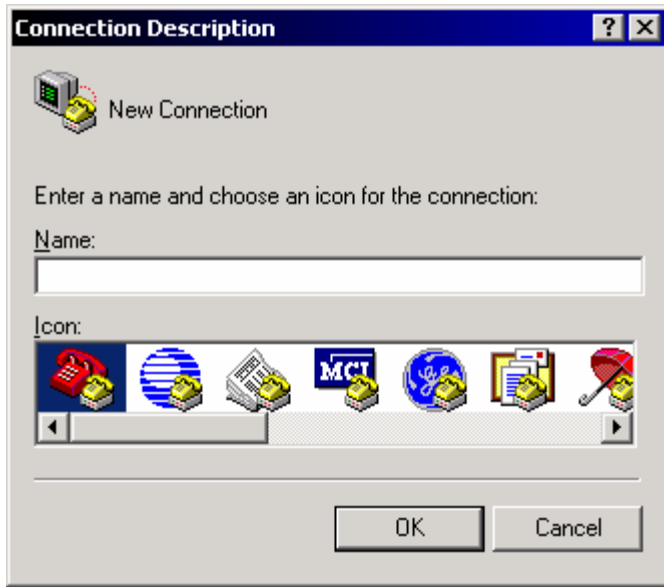

*Figure K-2 - HyperTerminal Connection Description*

Enter a name for your new connection in the space provided. The name should reflect the nature of the connection's use. In this case, a good name would be "COM1 Direct" or "COM2 Direct", depending on which serial port you are using on your computer. The word "Direct" indicates that you are making a direct connection to the port. You do not need a modem for a direct connection. When you have selected your connection name, press the OK button. This should invoke the "Connect To" dialog box, as shown below.



*Figure K-3 - HyperTerminal Connect To dialog box*

	SYSTEM	<b>Profiler II Ocean Profiler</b>
	SECTION	<b>K – APPENDIX A</b>

As your connection does not involve a modem, only the “Connect using:” dropdown box is needed. Select a direct connection to your desired serial port as shown. After you make your selection, press the OK button. Finally, HyperTerminal will open a communications properties dialog box for the serial port you selected. An example dialog box, for COM1, is shown below.

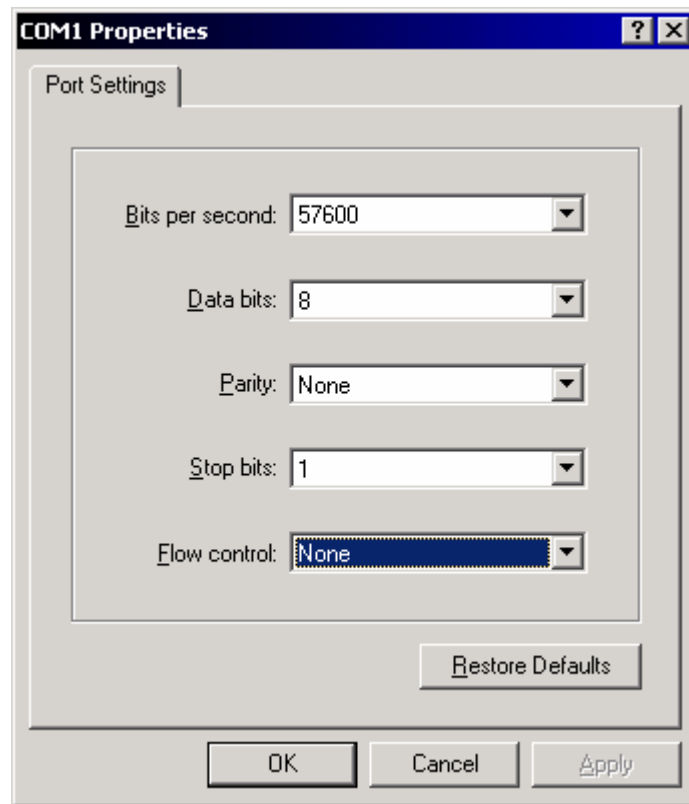
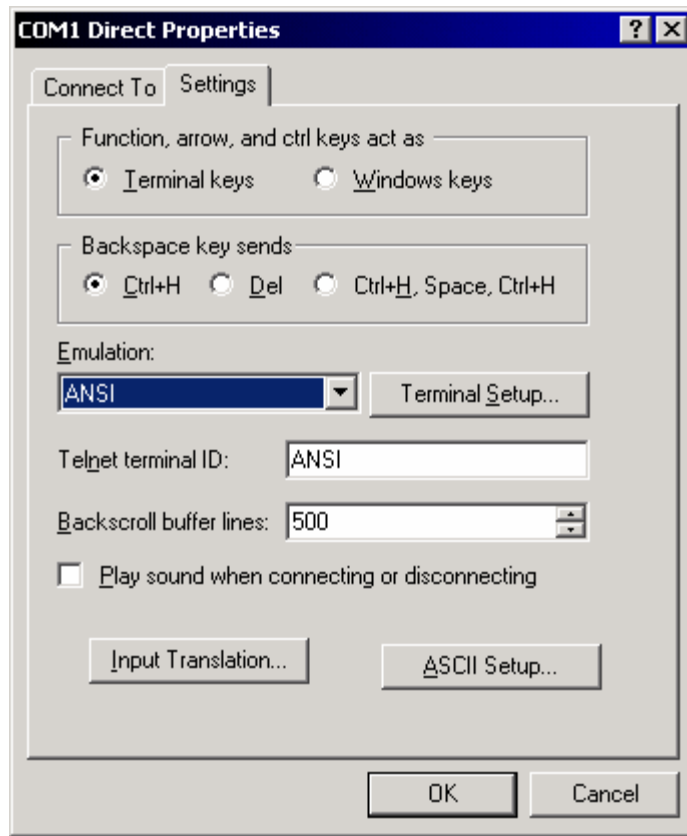

*Figure K-4 – Serial Port Properties dialog box*

The parameters of this dialog box should be set to the specifications of your instrument’s telemetry interface. In most cases, this is 8 data bits, no parity, one stop bit, and no flow control. The “Bits per second:” dropdown box should be set to the baud rate of the telemetry interface. Keep in mind that you may change the properties of your connection at any time after your initial setup. Once you have chosen your settings, press the OK button. HyperTerminal will then connect to the serial port, which should be connected to your instrument, and display the main window.

You must now configure HyperTerminal’s emulation options for use with your instrument. Before you do so, you will have to disconnect HyperTerminal from the serial port. You can reconnect later when you are finished. Under the **Call** menu, select **Disconnect**. You can reconnect later with the **Call** menu item. To complete HyperTerminal’s configuration, under the **File** menu, select **Properties** to open the connection’s Properties dialog box. Select the “Settings” tab as shown below.

	SYSTEM	<b>Profiler II Ocean Profiler</b>
	SECTION	<b>K – APPENDIX A</b>



*Figure K-5 – Connection Properties dialog box*

In the “Emulation:” dropdown box, select ANSI as the connection’s terminal emulation mode. The other settings of the dialog box should be set as shown. When you have completed setting these parameters, press the “ASCII Setup” button to open the ASCII Setup dialog box, as shown below.

	SYSTEM	<b>Profiler II Ocean Profiler</b>
	SECTION	<b>K – APPENDIX A</b>

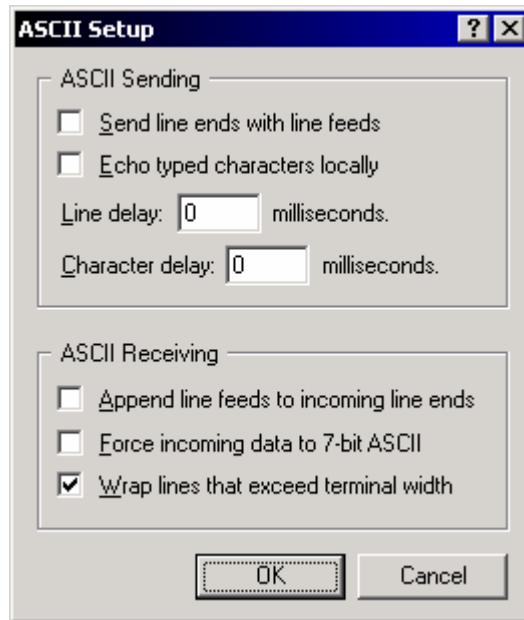

*Figure K-6 – ASCII Setup dialog box*

Make sure this dialog box is setup as shown. These settings are important in maintaining proper character I/O with your instrument. You are now ready to use HyperTerminal to establish instrument communications.

You should only have to go through this setup process once. HyperTerminal will save all your connection information in a HyperTerminal file (\*.ht). To reestablish your connection, simply open this file. HyperTerminal will open and automatically connect to the serial port with the saved settings.